

# price list



<b>Finishes</b>	p. 02
<b>Drain finishes</b>	p. 04
<b>Configurator</b>	p. 05
<b>Rimless 2.0.1</b>	p. 06
<b>Certifications</b>	p. 09
<b>Index by collections</b>	p. 10
<b>Index by type</b>	p. 11
<b>Price List</b>	p. 20

# FINITURE \ FINISHES

## Le Terre di Cielo

ceramic matt finishes



**TL** - Talco



**PM** - Pomice



**BR** - Brina



**CM** - Cemento



**BA** - Basalto



**LV** - Lavagna



**FN** - Fango



**CA** - Cacao



**AN** - Arenaria



**AV** - Avena



**MU** - Muschio



**AG** - Agave



**LN** - Lino



**CN** - Canapa



**CP** - Cipria



**PL** - Polvere

## Le Acque di Cielo

ceramic glossy finishes



**CO** - Corallo



**AM** - Anemone



**NI** - Ninfea



**AL** - Alga



**SM** - Smeraldo



**OL** - Oltremare

## Standard

ceramic



Bianco Lucido  
Glossy White



**N** - Nero Lucido  
/ Glossy Black

## Le Pietre collection



**CS** - Carrara  
Statuario



**BC** - Breccia  
Arabescata



**GS** - Grey  
Stone



**BP** - Breccia  
Paradiso



**NQ** - Nero  
Marquina

**Laccature legno**  
Wood lacquering



**TL** - Talco



**PM** - Pomice



**BR** - Brina



**AN** - Arenaria



**AV** - Avena



**CM** - Cemento



**BA** - Basalto



**MU** - Muschio

**EsSENze legno**  
wooden essences



**RS** - Rovere  
Sbiancato



**RN** - Rovere  
Naturale



**RG** - Rovere  
Grigio



**RO** - Rovere  
Nero



**EU** - Eucalipto



**NA** - Frassino  
Naturale



**NM** - Frassino  
tinto nero

**Marmi / pietre**  
marbles / stones

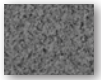

**AZ** - Azul  
Noche



**MB** - Bianco  
Carrara  
Gioia



**MN** - Nero  
Marquina

**Metalli**  
metals



**NM** - Nero  
Matt /  
Matt Black



**FE** - Nero Matt  
/ Matt Black  
(for Argo,  
Pluto Polifemo  
mirrors)

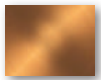

**BZ** - Bronzo  
Spazzolato  
/ Brushed  
Bronze



**CM** - Cemento



**CR** - Cromo  
/ Chrome



**IL** - Acciaio  
Lucidato /  
Gloss steel  
(for PAN  
mirror)

**Fenix**

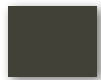

**FGR** - Grafite



**FTI** - Titanio



**FJU** - Juta



**FCO** - Cotone



**FCA** - Carminio



**FZO** - Zolfo

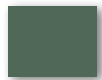

**FFE** - Felce



**FCB** - Cobalto

**LivingTec**

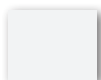

**BI** - Bianco  
Matt / Matt  
White



**BR** - Brina

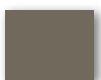

**AN** - Arenaria

**Cuoio**  
leather

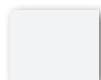

**BI** - Bianco  
Matt / Matt  
White



**NE** - Nero  
Matt / Matt  
Black



**NA** - Naturale



# PILETTE / DRAINS

## STANDARD COMBINATION DRAIN PIL01: METAL PART / CERAMIC COVER

COMBINACIÓN ESTÁNDAR VÁLVULA PIL01: PARTE METÁLICA / TAPA EN CERÁMICA - ASSOCIATION STANDARD BONDE PIL01: PARTIE MÉTALLIQUE / CLAPET EN CÉRAMIQUE  
 - STANDARD-KOMBINATION ABLAUGARNITUR PIL01: METALLUNTERTEIL / KERAMIKSTOPFEN - СТАНДАРТНАЯ КОМБИНАЦИЯ ДОННОГО КЛАПАНА PIL01:  
 МЕТАЛЛИЧЕСКАЯ ЧАСТЬ / ПРОБКА ИЗ КЕРАМИКИ

The ceramic cover for the drain has a metal body in **CHROME**. / La tapa de cerámica tiene un cuerpo de metal **CROMADO**. / L'abattant en céramique a un corps en métal, finition **CROMO**. / Keramikstopfen mit Metallkorpus in der Ausführung **CHROM**. / Керамическая крышка с металлическим корпусом в отделке **CROMO**.



The ceramic cover for the drain has a metal body in the **CEMENTO** finish. / La tapa de cerámica tiene un cuerpo de metal **CEMENTO**. / L'abattant en céramique a un corps en métal, finition **CEMENTO**. / Keramikstopfen mit Metallkorpus in der Ausführung **CEMENTO**. / Керамическая крышка с металлическим корпусом в отделке **CEMENTO**.



The ceramic cover for the drain has a metal body in the **GLOSS BLACK** finish. / La tapa de cerámica tiene un cuerpo de metal **NEGRO BRILLANTE**. / L'abattant en céramique a un corps en métal, finition **NERO LUCIDO**. / Keramikstopfen mit Metallkorpus in der Ausführung **GLÄNZEND SCHWARZ**. / Керамическая крышка с металлическим корпусом в отделке **NERO LUCIDO**.



The ceramic cover for the drain has a metal body in the **MATT BLACK** finish. / La tapa de cerámica tiene un cuerpo de metal **NEGRO MATE**. / L'abattant en céramique a un corps en métal, finition **NERO MATT**. / Keramikstopfen mit Metallkorpus in der Ausführung **MATT SCHWARZ**. / Керамическая крышка с металлическим корпусом в отделке **NERO MATT**.

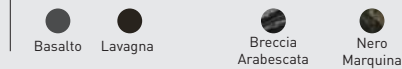

### CERAMIC

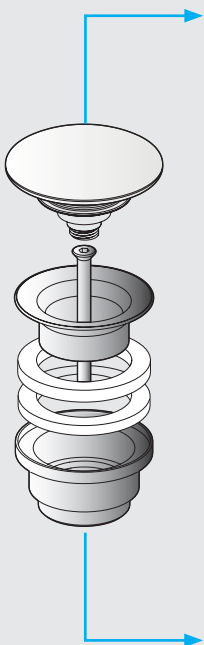

- Glossy White
- Glossy Black

#### Le Terre di Cielo

- Talco
- Pomice
- Brina
- Cemento
- Basalto
- Lavagna
- Fango
- Cacao
- Arenaria
- Avena
- Muschio
- Agave
- Lino
- Canapa
- Cipria
- Polvere

#### Le Acque di Cielo

- Oltremare
- Smeraldo
- Alga
- Corallo
- Ninfea
- Anemone

#### Le Pietre

- Carrara Statuario
- Breccia Arabescata
- Grey Stone
- Breccia Paradiso
- Nero Marquina

### METAL

- Cromo / Chrome
- Nero Matt / Matt Black
- Cemento
- Bronzo Spazzolato / Brushed Bronze

Variations can be made to the combinations on request, including the use of bronze or cementometal parts. A petición, se pueden hacer variaciones en la combinación, incluido el uso de la parte metálica en bronce\cemento - Sur demande nous pouvons varier les associations de finitions, notamment avec l'utilisation de la partie métallique en bronze\cemento - Auf Anfrage sind auch andere Kombinationen möglich, zum Beispiel Bronze\Cemento für das Metallunterteil - По запросу возможно внести изменения в комбинацию, в том числе использовать металлическую часть в отделке bronzocemento.

# CONFIGURATORE CONFIGURATOR

EN



go to the configurator

SP



ir al configurador

FR



lien vers le configurateur

DE



Zum Konfigurator

RU



Перейдите в  
конфигуратор

An easy and immediate digital tool, organised by collections and types, capable of instantly displaying the chosen configuration, allowing you to generate a quote and send an order directly to Cielo.

Una herramienta digital fácil e inmediata, organizada por colecciones y tipos, capaz de ver instantáneamente la configuración elegida, lo que le permite generar una cotización y hacer un pedido directamente a Cielo.

Un outil numérique simple et immédiat, organisé par collections et types, capable d'afficher instantanément la configuration de votre choix, qui vous permet de générer un devis et d'envoyer une commande directement à Cielo.

Ein benutzerfreundliches und intuitives digitales Instrument, das in Kollektionen und Produkttypen unterteilt ist und die gewählte Konfiguration sofort anzeigen, einen Kostenvoranschlag generieren und diesen direkt an Cielo übermitteln kann.

Простой и быстрый цифровой инструмент, организованный по коллекциям и типологии, способный отображать выбранную конфигурацию, создать предложение и отправить заказ напрямую на фабрику Cielo.

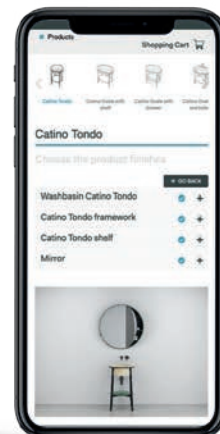
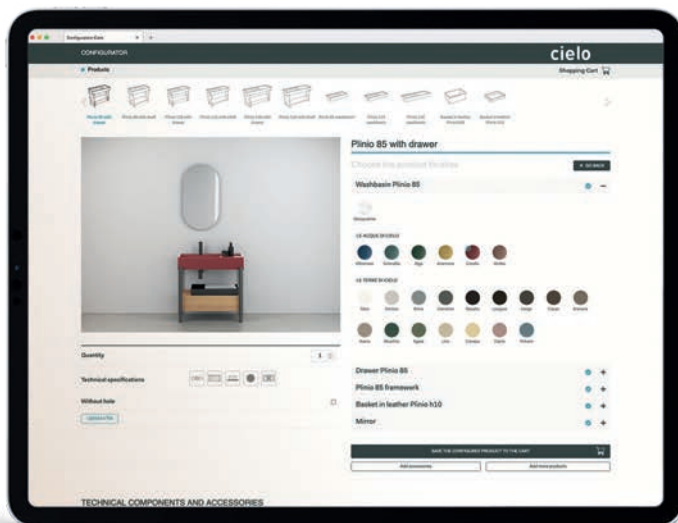

# CIELO RIMLESS 2.0.1®

## PURE INNOVATION



maximum discharge efficiency

The new Rimless 2.0.1 sanitary fittings integrate functionality, aesthetics, hygiene and water saving. Never has any toilet combined so many features all at once. The exclusive Rimless 2.0.1 technology, patented by Cielo, has made it possible to create a completely revolutionary sanitary fitting.

Los nuevos sanitarios sin brida, que adoptando el nuevo sistema Rimless 2.0.1, integra funcionalidad, estética, higiene y ahorro de agua. Ningún inodoro ha combinado nunca tantas funciones juntas. La exclusiva tecnología Rimless 2.0.1, patentada por Cielo, ha permitido crear un sanitario completamente revolucionario.

Les nouveaux appareils sanitaires sans rebord, qui adoptent le nouveau système Rimless 2.0.1, combinent fonctionnalité, esthétique, hygiène et économie d'eau. Aucun autre WC n'a jamais réuni autant de caractéristiques en même temps. La technologie exclusive Rimless 2.0.1, brevetée par Cielo, a permis de réaliser un appareil sanitaire totalement révolutionnaire.

Die neuen, mit dem neuen Rimless 2.0.1-System ausgestatteten WCs ohne Spülrand kombinieren Zweckmäßigkeit und Ästhetik mit Hygiene und einem reduzierten Wasserverbrauch. Kein WC hat je zuvor so viele Merkmale auf sich vereint. Die exklusive, von Cielo patentierte Rimless 2.0.1-Technologie hat die Herstellung eines absolut revolutionären WCs möglich gemacht.

Новые безободковые унитазы, в которых используется новая система Rimless 2.0.1, объединяют в себе функциональность, эстетику, гигиену и экономию воды. Ни один унитаз никогда не сочетал в себе столько функций. Эксклюзивная технология Rimless 2.0.1, запатентованная Cielo, позволила создать совершенно революционную сантехнику.



# PERFECT INTEGRATION BETWEEN TECHNOLOGY AND DESIGN

	EN	SP	FR	DE	RU
 <p><b>water saving</b></p>	<p>The Rimless 2.0.1 guarantees an efficient flush at only 4.5 litres.</p>	<p>Rimless 2.0.1 garantiza una descarga eficiente con solo 4,5 Lt.</p>	<p>Rimless 2.0.1 garantit une chasse d'eau efficace avec seulement 4,5 litres.</p>	<p>Rimless 2.0.1 garantiert eine effiziente Spülleistung mit nur 4,5 l.</p>	<p>Rimless 2.0.1 гарантирует эффективный смыв всего с 4,5 литрами воды.</p>
 <p><b>maximum cleaning efficiency</b></p>	<p>In the Rimless 2.0.1 the water jet is specifically designed to reach every point of the toilet bowl for complete hygiene.</p>	<p>Con rimless 2.0.1, el chorro de agua fue diseñado para llegar a todos los puntos de la cerámica para una higiene total.</p>	<p>Avec Rimless 2.0.1, le jet d'eau a été spécialement conçu pour atteindre chaque point de la céramique pour une hygiène totale.</p>	<p>bei Rimless 2.0.1 ist der Wasserstrahl so konzipiert, dass er alle Stellen der Keramik erreicht, für absolute Hygiene.</p>	<p>В унитазах Rimless 2.0.1 циркуляция воды была специально разработана таким образом, чтобы было возможно добраться до всех точек унитаза для.</p>
 <p><b>silence</b></p>	<p>Thanks to the Rimless 2.0.1 technology the tests have shown that discharge is up to 40% more silent.</p>	<p>Gracias a la tecnología Rimless 2.0.1 las pruebas muestran que es hasta un 40% mas silencioso.</p>	<p>Grâce à la technologie Rimless 2.0.1, les tests démontrent que l'évacuation est jusqu'à 40 % plus silencieuse.</p>	<p>Für die Rimless 2.0.1-Technologie stellen die Tests einen bis zu 40 % leiseren Spülvorgang unter Beweis.</p>	<p>Испытания показали, что благодаря технологии Rimless 2.0.1, слив воды на 40% тише.</p>
 <p><b>elimination of drips</b></p>	<p>The Rimless 2.0.1 technology guarantees the reduction of drips inside the toilet bowl caused by flushing mechanisms, which often produce unsightly limescale deposits.</p>	<p>La tecnología Rimless 2.0.1 garantiza la reducción de goteos dentro del lavabo del inodoro, causados por los mecanismos de descarga, que a menudo producen depósitos de cal antiestéticos.</p>	<p>La technologie Rimless 2.0.1 permet la réduction des gouttes à l'intérieur de la cuvette WC causées par les mécanismes de chasse d'eau, qui produisent souvent des dépôts de calcaire inesthétiques.</p>	<p>Die Rimless 2.0.1-Technologie garantiert eine Reduzierung des vom Spülmechanismus verursachten Tropfwassers im Beckeninneren des WCs, das oft unschöne Kalkablagerungen verursacht.</p>	<p>Технология Rimless 2.0.1 гарантирует уменьшение капель внутри унитаза, вызванных смывными механизмами, которые зачастую приводят к неприглядным отложениям известкового налета.</p>
 <p><b>no splashes</b></p>	<p>No need for pressure reducers in combination with adjustable flushing systems.</p>	<p>No se necesitan reductores de presión en combinación con sistemas de escape ajustables.</p>	<p>Pas besoin de réducteurs de pression en association avec les systèmes de chasse d'eau réglables.</p>	<p>Keine Notwendigkeit von Druckminderern in Kombination mit einstellbaren Spülsystemen.</p>	<p>Не требуются редуктора давления в сочетании с регулируемыми системами слива.</p>
 <p><b>unique design</b></p>	<p>Total absence inside the basin of visible flushing channels or holes or other unhygienic and unattractive solutions.</p>	<p>Ausencia total en el interior del lavabo de canales o desagües visibles u otras soluciones antiestéticas y antihigiénicas.</p>	<p>Absence totale, dans la cuvette, de canaux ou de trous apparents ou d'autres solutions inesthétiques et non hygiéniques.</p>	<p>Keine sichtbaren Spülrinnen, Spülöffnungen oder andere unschöne und unhygienische Lösungen im Beckeninneren.</p>	<p>Полное отсутствие внутри чаши каналов или видимых сливных отверстий или других антиэстетических и негигиеничных решений.</p>



# CERTIFICAZIONI CERTIFICATIONS



Licence No: WMK26331



Reg. No. 20518 - A



Reg. No. 20518 - E

To see which of our products are certified for the USA and Canadian markets, please consult our website: [www.csagroup.org](http://www.csagroup.org), in the CSA GROUP - PRODUCT LISTING section and search for Ceramica Cielo in the appropriate search field. Para ver cuáles de nuestros productos están certificados para los mercados de EE. UU. Y CANADÁ, consulte el sitio web [www.csagroup.org](http://www.csagroup.org), en la sección CSA GROUP - PRODUCT LISTING y busque Ceramica Cielo en el campo adecuado. Parmi les produits que nous proposons, pour visualiser ceux qui sont certifiés pour les marchés États-Unis et Canada, consulter le site [www.csagroup.org](http://www.csagroup.org), sélectionner la section GROUPE CSA - Liste de produits du Groupe CSA et saisir Ceramica Cielo dans le champ de recherche approprié. Um zu erfahren, welche unserer Produkte für die Märkte USA und KANADA zertifiziert sind, besuchen Sie die Website [www.csagroup.org](http://www.csagroup.org), Abschnitt CSA GROUP - PRODUCT LISTING, und geben Sie im entsprechenden Suchfeld Ceramica Cielo ein. Чтобы увидеть, какие из наших продуктов сертифицированы для рынков США и Канады, посетите веб-сайт [www.csagroup.org](http://www.csagroup.org), в разделе CSA GROUP - СПИСОК ПРОДУКТОВ найдите Ceramica Cielo в соответствующей области исследований.

To see which of our products are certified for the AUSTRALIAN and NEW ZEALAND markets, go to [register.saiglobal.com](http://register.saiglobal.com), choose the "company name" option and type CERAMICA CIELO into the field and hit enter. Para ver cuáles de nuestros productos están certificados para los mercados de AUSTRALIA y NUEVA ZELANDA, consulte la web [register.saiglobal.com](http://register.saiglobal.com), elija la opción "company name" y en el campo de búsqueda introduzca Cerámica Cielo. Parmi les produits que nous proposons, pour visualiser ceux qui sont certifiés pour les marchés Australie et Nouvelle-Zélande, consulter le site [register.saiglobal.com](http://register.saiglobal.com), sélectionner l'option « Company Name » dans le champ de recherche et saisir Ceramica Cielo. Um zu erfahren, welche unserer Produkte für die Märkte AUSTRALIEN und NEUSEELAND zertifiziert sind, besuchen Sie die Website [register.saiglobal.com](http://register.saiglobal.com), wählen Sie im Suchfeld die Option „Company Name“ und geben Sie Ceramica Cielo ein. Чтобы узнать, какие из наших продуктов сертифицированы для рынков АВСТРАЛИИ и НОВОЙ ЗЕЛАНДИИ, посетите сайт [register.saiglobal.com](http://register.saiglobal.com), выберите опцию «название компании» и в поле поиска введите Ceramica Cielo.

To search for which of our products are certified for the Australian and New Zealand markets, visit this website - [www.waterrating.gov.au](http://www.waterrating.gov.au), under the "search for product" section type "toilets" and the brand name "Ceramica Cielo spa". Para visualizar que nuestros productos son certificados para el mercado de AUSTRALIA y NUOVA ZELANDA, consulte la web [www.waterrating.gov.au](http://www.waterrating.gov.au), seleccione "search for a product" y "toilets" y escriba "Ceramica Cielo spa". Pour visualiser quels sont nos produits certifiés pour les marchés AUSTRALIE et NOUVELLE-ZÉLANDE, consulter le site [www.waterrating.gov.au](http://www.waterrating.gov.au), sous l'option « search for a product », sélectionner « toilets » et introduire le nom de la marque « Ceramica Cielo spa ». Um zu erfahren, welche unserer Produkte für die Märkte AUSTRALIEN und NEUSEELAND zertifiziert sind, besuchen Sie die Website [www.waterrating.gov.au](http://www.waterrating.gov.au), wählen Sie unter „search for a product“ die Option „toilets“ und geben Sie den Markennamen „Ceramica Cielo spa“ ein. Чтобы узнать, какие из наших продуктов сертифицированы для рынков АВСТРАЛИИ и НОВОЙ ЗЕЛАНДИИ, посетите сайт [www.waterrating.gov.au](http://www.waterrating.gov.au), в разделе "поиск продуктов" выберите "toilets" и внесите название бренда "Ceramica Cielo spa".

**ISO 9001:2015**  
Quality management system certification.  
Certificación del Sistema de Gestión de Calidad.  
Certification du système de management de la qualité.  
Zertifizierung des Qualitätsmanagementsystems.  
Сертификация системы менеджмента качества.

**ISO 14001:2015**  
Quality management system certification.  
Certificación del Sistema de Gestión de Calidad.  
Certification du système de management de la qualité.  
Zertifizierung des Qualitätsmanagementsystems.  
Сертификация системы менеджмента качества.

# INDICE PER COLLEZIONE

## INDEX BY COLLECTION

<b>Marcel</b>	p. 20	<b>Le Bacinelle</b>	p. 372
<b>Theo</b>	p. 30	<b>Mare</b>	p. 382
<b>Les Petites</b>	p. 70	<b>Era</b>	p. 394
<b>I Catini</b>	p. 100	<b>Le Giare</b>	p. 412
<b>I Catini - Tiberio</b>	p. 130	<b>Shui Comfort</b>	p. 426
<b>Delfo</b>	p. 156	<b>Shui</b>	p. 444
<b>Siwa</b>	p. 196	<b>Smile</b>	p. 458
<b>Kyros</b>	p. 214	<b>Enjoy</b>	p. 480
<b>Elle</b>	p. 224	<b>Fluid</b>	p. 494
<b>Sella \ Sella T</b>	p. 244	<b>Piatti doccia</b>	p. 508
<b>Plinio</b>	p. 258	<b>Orinatoio</b>	p. 542
<b>Multiplo</b>	p. 270	<b>Ricambi</b>	p. 550
<b>Milano</b>	p. 288	<b>Fuori</b>	
<b>I Narcisi</b>	p. 298	<b>produzione</b>	p. 562
<b>Arcadia</b>	p. 322	<b>Merchandising</b>	p. 570
<b>Arcadia - Tiberino</b>	p. 334	<b>Sales Terms</b>	p. 574
<b>Luisa</b>	p. 350		
<b>Accessori</b>	p. 358		

# INDICE PER TIPOLOGIA

## INDEX BY TYPE

### Lavabi con mobile e/o struttura

### Washbasins with cabinet or framework

#### Tiberio



**Tiberio**  
cm 56 x 48 x 84 h  
pg. 130

#### I Catini - Tondo, Ovale



**Catino tondo**  
cm Ø50 x 83 h  
pg. 142



**Catino ovale con piano**  
Catino ovale with shelf  
cm 70 x 50 x 83 h  
pg. 144



**Catino ovale monoforo con piano**  
Catino ovale with 1 hole with shelf  
cm 70 x 50 x 83 h  
pg. 144



**Catino ovale con cassetto**  
Catino ovale with drawer  
cm 70 x 50 x 83 h  
pg. 144



**Catino ovale monoforo con cassetto**  
Catino ovale with 1 hole with drawer  
cm 70 x 50 x 83 h  
pg. 144

#### I Catini - Doppio, Rettangolare



**Catino doppio con piano**  
Catino doppio with shelf  
cm 110 x 58,5 x 83 h  
pg. 148

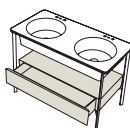

**Catino doppio con cassetto**  
Catino doppio with drawer  
cm 110 x 58,5 x 83 h  
pg. 148



**Catino rettangolare con piano**  
Catino rettangolare with shelf  
cm 110 x 58,5 x 83 h  
pg. 150



**Catino rettangolare con cassetto**  
Catino rettangolare with drawer  
cm 110 x 58,5 x 83 h  
pg. 150

#### Marcel

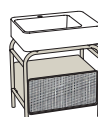

**Marcel**  
cm 72 x 50 x 87 h  
pg. 28

#### Milano



**Milano**  
cm 120 x 50 x 85 h  
pg. 296



**Milano con cassetto**  
Milano with drawer unit  
cm 120 x 50 x 85 h  
pg. 296

#### I Narcisi



**Narciso vanity**  
cm 130 x 50 x 83 h  
pg. 316



**Narciso doppio**  
cm 113 x 50 x 83 h  
pg. 320

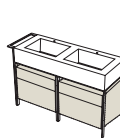

**Narciso doppio con cassetto**  
Narciso doppio with drawers  
cm 113 x 50 x 83 h  
pg. 320



**Narciso mini con cassetto e box**  
Narciso mini with drawer unit and box  
cm 76 x 50 x 83 h  
pg. 318



**Narciso mini con cassetto**  
Narciso mini with drawer  
cm 76 x 50 x 83 h  
pg. 318



+ **Sacca in cuoio Narciso**  
Narciso leather bag  
cm 45 x 14 x 50 h  
pg. 316

#### Kyros



**Kyros lavabo con struttura e mobile**  
Kyros washbasin with framework and cabinet  
cm 78,5 x 50 x 85 h  
pg. 222

#### Siwa



**Siwa lavabo con vassoio**  
Siwa washbasin with tray  
cm 92 x 51 x 89 h  
pg. 210



**Siwa lavabo con cassetto**  
Siwa washbasin with drawer  
cm 92 x 51 x 89 h  
pg. 210

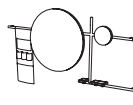

**Siwa specchiera tonda**  
Siwa round mirror  
cm 210 x 14 x 94 h  
pg. 212

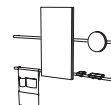

**Siwa specchiera rettangolare**  
Siwa rectangular mirror  
cm 154 x 14 x 110 h  
pg. 213



# Lavabi con mobile e/o struttura

## Washbasins with cabinet or framework

### Elle Tonda



**Elle tonda**  
cm 50 x 50 x 52 h  
pg. 236

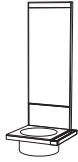

**Elle tonda con specchio**  
Elle tonda with mirror  
cm 50 x 50 x 130 h  
pg. 238

+



**Otto pouf tondo**  
Otto round pouf  
cm 40 x 40 x 43 h  
pg. 236

### Elle Ovale



**Elle ovale**  
cm 70 x 50 x 52 h  
pg. 240



**Elle ovale con specchio**  
Elle ovale with mirror  
cm 70 x 50 x 130 h  
pg. 242

+

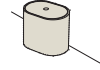

**Otto pouf ovale**  
Otto oval pouf  
cm 60 x 40 x 43 h  
pg. 240

### Plinio



**Plinio 85 con piano**  
Plinio 85 with shelf  
cm 85 x 46 x 83 h  
pg. 268



**Plinio 115 con piano**  
Plinio 115 with shelf  
cm 115 x 46 x 83h  
pg. 268



**Plinio 140 con piano**  
Plinio 140 with shelf  
cm 140 x 46 x 83h  
pg. 268

+



**Cesta in cuoio h28**  
Basket in leather h28  
cm 63 x 36 x 28 h  
pg. 269



**Plinio 85 con cassetto**  
Plinio 85 with drawer  
cm 85 x 46 x 83 h  
pg. 268



**Plinio 115 con cassetto**  
Plinio 115 with drawer  
cm 115 x 46 x 83h  
pg. 268

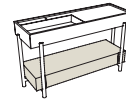

**Plinio 140 con cassetto**  
Plinio 140 with drawer  
cm 140 x 46 x 83h  
pg. 268

+



**Cesta in cuoio h10**  
Basket in leather h10  
cm 63 x 36 x 10 h  
pg. 269

### Delfo



**Delfo 76**  
mobile con ante frontali lisce  
Delfo 76 cabinet with smooth front doors  
cm 76 x 52 x 47 h  
pg. 176



**Delfo 76**  
mobile con ante frontali in listelli di massello triangolari  
Delfo 76 cabinet with front doors in solid triangular strips  
cm 75,5 x 52 x 47 h  
pg. 176

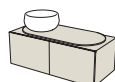

**Delfo 113**  
mobile con ante frontali lisce  
Delfo 113 cabinet with smooth front doors  
cm 113 x 52 x 47 h  
pg. 178

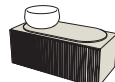

**Delfo 113**  
mobile con ante frontali in listelli di massello triangolari  
Delfo 113 cabinet with front doors in solid triangular strips  
cm 113 x 52 x 47 h  
pg. 178

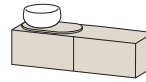

**Delfo 152**  
mobile con ante frontali lisce  
Delfo 152 cabinet with smooth front doors  
cm 152 x 52 x 62 h  
pg. 180

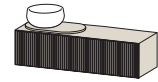

**Delfo 152**  
mobile con ante frontali in listelli di massello triangolari  
Delfo 152 cabinet with front doors in solid triangular strips  
cm 152 x 52 x 62 h  
pg. 180

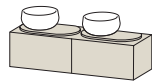

**Delfo 152**  
mobile con ante frontali lisce  
Delfo 152 cabinet with smooth front doors  
cm 152 x 52 x 62 h  
pg. 184

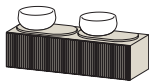

**Delfo 152**  
mobile con ante frontali in listelli di massello triangolari  
Delfo 152 cabinet with front doors in solid triangular strips  
cm 152 x 52 x 62 h  
pg. 184

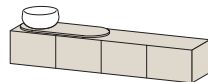

**Delfo 226**  
mobile con ante frontali lisce  
Delfo 226 cabinet with smooth front doors  
cm 226 x 52 x 62 h  
pg. 188

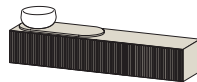

**Delfo 226**  
mobile con ante frontali in listelli di massello triangolari  
Delfo 226 cabinet with front doors in solid triangular strips  
cm 226 x 52 x 62 h  
pg. 188

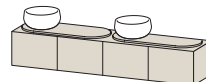

**Delfo 226**  
mobile con ante frontali lisce  
Delfo 226 cabinet with smooth front doors  
cm 226 x 52 x 62 h  
pg. 192



**Delfo 226**  
mobile con ante frontali in listelli di massello triangolari  
Delfo 226 cabinet with front doors in solid triangular strips  
cm 226 x 52 x 62 h  
pg. 192

## Sella



**Sella lavabo con elemento portaoggetti**  
Sella washbasin with storage unit  
cm 110 x 48 x 20 h  
pg. 252

## Sella T



**Sella T lavabo con elemento portaoggetti in Fenix**  
Sella T washbasin with storage unit in Fenix  
cm 110 x 48 x 20 h  
pg. 256

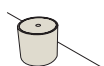

**Otto pouf tondo**  
Otto round pouf  
cm 40 x 40 x 43 h  
pg. 252

## Les Petites



**Les Petites Quadrato con piano in ceramica**  
Les Petites square with ceramic shelf  
cm 41 x 35 x 56 h  
pg. 94



**Les Petites Ovale 46 con piano in ceramica**  
Les Petites oval 46 with ceramic shelf  
cm 46 x 30 x 56 h  
pg. 96



**Les Petites Ovale 60 con piano in ceramica**  
Les Petites oval 60 with ceramic shelf  
cm 60 x 30 x 56 h  
pg. 98



**Les Petites Quadrato con rete metallica**  
Les Petites square with wire mesh  
cm 41 x 35 x 56 h  
pg. 94



**Les Petites Ovale 46 con rete metallica**  
Les Petites oval 46 with wire mesh  
cm 46 x 30 x 56 h  
pg. 96



**Les Petites Ovale 60 con rete metallica**  
Les Petites oval 60 with wire mesh  
cm 60 x 30 x 56 h  
pg. 98

## Theo



**Theo Mini**  
cm 55,5 x 31 x 24 h  
pg. 54



**Theo 70**  
cm 72,5 x 38 x 29 h  
pg. 56

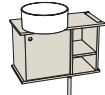

**Theo 78**  
cm 78 x 38 x 87 h  
pg. 58

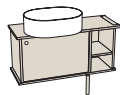

**Theo 103**  
cm 103 x 38 x 87 h  
pg. 60

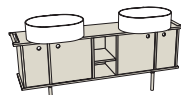

**Theo 175 con 4 ante e un vano giorno**  
Cabinet with 4 doors and an open compartment  
cm 175 x 38 x 87 h  
pg. 62

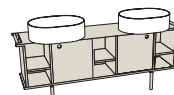

**Theo 175 con 2 ante e 3 vani giorno**  
Cabinet with 2 doors and 3 open compartments  
cm 175 x 38 x 87 h  
pg. 64

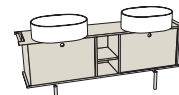

**Theo 175 con 2 cassettoni e un vano giorno**  
Cabinet with 2 drawers and an open compartment  
cm 175 x 38 x 87 h  
pg. 66

## Tiberino



**Tiberino mobile freestanding con scarico a terra**  
Tiberino freestanding cabinet with floor trap  
cm 50 x 50 x 85 h  
pg. 334



**Tiberino mobile freestanding con scarico a parete**  
Tiberino freestanding cabinet with wall trap  
cm 50 x 50 x 85 h  
pg. 334

## Multiplo



**Minimultiplo**  
cm 40 x 29  
pg. 282



**Multiplo versione solo piano in ceramica**  
Multiplo ceramic shelf version  
cm 40\48 X 10 h  
pg. 283



**Multiplo versione piano in ceramica e mobile a giorno**  
Multiplo ceramic shelf and open day cabinet version  
cm 48 x 38 h  
pg. 284



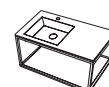





























## Era

















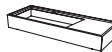
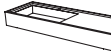

**Era lavabo con struttura**  
Era washbasin with framework  
pg. 399

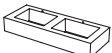
# Lavabi Washbasins





















## Lavabi da piano senza foro rubinetto / On top washbasins without tap hole

 <b>Catino Tondo</b> cm Ø45 x 16 h pg. 132	 <b>Catino Ovale 55</b> cm 55 x 42 x 16 h pg. 132	 <b>Catino Ovale 65</b> cm 65 x 42 x 16 h pg. 132	 <b>Theo Tondo</b> cm Ø40 x 16 h pg. 53	 <b>Theo Ovale</b> cm 55 x 40 x 16 h pg. 53	 <b>Tino Mini</b> cm Ø30 x 14,5 h pg. 92	 <b>Tino</b> cm Ø43 x 19 h pg. 378	 <b>Tina</b> cm Ø45 x 26 h pg. 378			
 <b>Eco 62</b> cm 62 x 45 x 18 h pg. 404	 <b>Eco Small 58</b> cm 58 x 45 x 16,5 h pg. 404	 <b>Era 45</b> cm Ø45 x 24 h pg. 404	 <b>Era Small 40</b> cm Ø40 x 15 h pg. 404	 <b>Mare Tondo</b> cm Ø45 x 15 h pg. 388	 <b>Mare Ovale</b> cm 60 x 38 x 15 h pg. 388	 <b>Mare Rettangolare</b> cm 60 x 38 x 15 h pg. 388	 <b>Shui 40</b> cm Ø40 x 18,5 h pg. 448	 <b>Shui 45</b> cm Ø45 x 12,5 h pg. 448	 <b>Shui 42</b> cm Ø42 x 16,5 h pg. 448	
 <b>Shui Comfort Tondo</b> cm Ø40 x 12,5 h pg. 432	 <b>Shui Comfort Ovale</b> cm 60 x 38 x 12,5 h pg. 432	 <b>Shui Comfort Rettangolare</b> cm 60 x 40 x 12,5 h pg. 432	 <b>Shui Comfort Quadrato</b> cm 40 x 40 x 12,5 h pg. 432	 <b>Minimo tondo</b> cm Ø25 x 11,5 h pg. 432	 <b>Minimo quadrato</b> cm 25 x 25 x 11,5 h pg. 432	 <b>Shui Comfort 60</b> cm 60 x 42 x 20 h pg. 434	 <b>Shui Comfort 75</b> cm 75 x 42 x 20 h pg. 434	 <b>Shui Comfort 100</b> cm 100 x 42 x 20 h pg. 434		
 <b>Shui 40</b> cm 40 x 40 x 15 h pg. 448	 <b>Shui 60</b> cm 60 x 40 x 15 h pg. 448	 <b>Shui 80</b> cm 80 x 40 x 15 h pg. 448	 <b>Le giare</b> cm 60 x 45 x 14,5 h pg. 420				 <b>Fluid 45</b> cm Ø45 x 14,5 h pg. 501	 <b>Fluid 60</b> cm 60 x 45 x 14,5 h pg. 501		

## Lavabi da piano con foro rubinetto / On top washbasins with tap hole

 <b>Mare 50</b> cm 50 x 40 x 15 h pg. 388	 <b>Mare 60</b> cm 60 x 47 x 15 h pg. 388	 <b>Mare 70</b> cm 70 x 47 x 15 h pg. 388	 <b>Marcel</b> cm 70 x 50 x 17 h pg. 28	 <b>Les Petites Ovale</b> cm 33,5 x 18,5 x 11,5 h pg. 91	 <b>Les Petites Rettangolare</b> cm 33,5 x 18,5 x 11,5 h pg. 91	 <b>Les Petites Tondo 28</b> cm ø28 x 11,5 h pg. 91	 <b>Les Petites Quadrato 28</b> cm 28 x 28 x 11,5 h pg. 91			
 <b>Les Petites Ovale 46</b> cm 46 x 30 x 16 h pg. 92	 <b>Les Petites Ovale 60</b> cm 60 x 30 x 16 h pg. 92	 <b>Les Petites Quadrato 35</b> cm 35 x 35 x 16 h pg. 92	 <b>Plinio 85</b> cm 85 x 46 x 16 h pg. 268	 <b>Plinio 115</b> cm 115 x 46 x 16 h pg. 268	 <b>Plinio 140</b> cm 140 x 46 x 16 h pg. 268	 <b>Narciso mini dx</b> cm 76 x 50 x 16,5 h pg. 318	 <b>Narciso mini sx</b> cm 76 x 50 x 16,5 h pg. 318	 <b>Narciso doppio</b> cm 113 x 50 x 16,5 h pg. 320		
 <b>Enjoy 50</b> cm 50 x 48 x 12,5 h pg. 486	 <b>Enjoy 60</b> cm 60 x 48 x 12,5 h pg. 486	 <b>Enjoy 70</b> cm 70 x 48 x 12,5 h pg. 486	 <b>Handy</b> cm Ø45 x 17 h pg. 404	 <b>Shui Comfort Tondo 45</b> cm Ø45 x 13 h pg. 434	 <b>Shui Comfort Quadrato 44</b> cm 44 x 43 x 13,5 h pg. 434	 <b>Shui Comfort Rettangolare</b> cm 60 x 43 x 13 h pg. 434				
 <b>Smile 50</b> cm 50 x 46 x 13 h pg. 464	 <b>Smile 60</b> cm 60 x 46 x 13 h pg. 464	 <b>Smile 80</b> cm 80 x 46 x 13 h pg. 464	 <b>Smile 100</b> cm 100 x 46 x 13 h pg. 464	 <b>Shui 66</b> cm 66 x 48,5 x 15 h pg. 450						

## Lavabi sospesi / Wall-hung washbasins

 <b>Mare 50</b> cm 50 x 40 x 15 h pg. 388	 <b>Mare 60</b> cm 60 x 47 x 15 h pg. 388	 <b>Mare 70</b> cm 70 x 47 x 15 h pg. 388	 <b>Marcel</b> cm 70 x 50 x 17 h pg. 28	 <b>Les Petites Quadrato 35</b> cm 35 x 35 x 16 h pg. 92	 <b>Les Petites Ovale 46</b> cm 46 x 30 x 16 h pg. 92	 <b>Les Petites Ovale 60</b> cm 60 x 30 x 16 h pg. 92	 <b>Siwa</b> cm 90 x 50 x 20 h pg. 210	
 <b>Plinio 85</b> cm 85 x 46 x 16 h pg. 268	 <b>Plinio 115</b> cm 115 x 46 x 16 h pg. 268	 <b>Plinio 140</b> cm 140 x 46 x 16 h pg. 268	 <b>Sella</b> cm 40 x 48 x 20 h pg. 252	 <b>Narciso mini dx</b> cm 76 x 50 x 16,5 h pg. 318	 <b>Narciso mini sx</b> cm 76 x 50 x 16,5 h pg. 318	 <b>Narciso doppio</b> cm 113 x 50 x 16,5 h pg. 320		
 <b>Shui Comfort Quadrato 44</b> cm 44 x 43 x 13,5 h pg. 434	 <b>Shui Comfort Rettangolare</b> cm 60 x 43 x 13 h pg. 434	 <b>Le giare 34</b> cm 34 x 50 x 30 h pg. 420	 <b>Le giare 56</b> cm 56 x 45 x 30 h pg. 419	 <b>Le giare 70</b> cm 70 x 56 x 59 h pg. 419	 <b>Enjoy 50</b> cm 50 x 48 x 12,5 h pg. 486	 <b>Enjoy 60</b> cm 60 x 48 x 12,5 h pg. 486	 <b>Enjoy 70</b> cm 70 x 48 x 12,5 h pg. 486	
 <b>Smile 50</b> cm 50 x 46 x 13 h pg. 464	 <b>Smile 60</b> cm 60 x 46 x 13 h pg. 464	 <b>Smile 80</b> cm 80 x 46 x 13 h pg. 464	 <b>Smile 100</b> cm 100 x 46 x 13 h pg. 464	 <b>Era 45</b> cm 45 x 34 x 14 h pg. 399	 <b>Era 48</b> cm 48 x 46 x 14 h pg. 399	 <b>Era 60 sx</b> cm 60 x 46 x 14 h pg. 400	 <b>Era 60 dx</b> cm 60 x 46 x 14 h pg. 400	 <b>Era 80 sx</b> cm 80 x 46 x 14 h pg. 401
 <b>Era 80 dx</b> cm 80 x 46 x 14 h pg. 401	 <b>Era 100 sx</b> cm 100 x 46 x 14 h pg. 402	 <b>Era 100 dx</b> cm 100 x 46 x 14 h pg. 402	 <b>Era 120 doppio</b> cm 120 x 46 x 14 h pg. 403	 <b>Shui 66</b> cm 66 x 48,5 x 15 h pg. 450				

## Lavabi semincasso e sottopiano / Semirecessed and undercounter washbasins



























 <b>Enjoy tondo</b> Semincasso Semirecessed cm Ø40 x 14 h pg. 487	 <b>Enjoy quadrato</b> Semincasso Semirecessed cm 40 x 40 x 14 h pg. 487	 <b>Enjoy sottopiano</b> Sottopiano Undercounter cm 42 x 40,5 x 18 h pg. 486	 <b>Enjoy ovale</b> Sottopiano Undercounter cm 44,5 x 52 x 18,5 h pg. 486	 <b>Enjoy rettangolare</b> Sottopiano Undercounter cm 41,5 x 53 x 17,5 h pg. 486
---	--	--	---	--

## Lavabi freestanding / Freestanding washbasins























 <b>Le Giare</b> cm 88 x 63 x 83 h pg. 418	 <b>Fluid</b> cm Ø45 x 82 h pg. 500	 <b>Fluid parete / on wall</b> cm Ø45 x 82 h pg. 500	 <b>Shui</b> cm 40 x 40 x 85 h pg. 451	 <b>Shui parete / on wall</b> cm 40 x 40 x 85 h pg. 451
--	---	--	--	---

# Sanitary wares





## Wc e bidet sospesi / Wall-hung wc and bidet

								
<b>Mare</b> Wc senza brida Rimless wc cm 54 x 37 x 28 h pg. 390	<b>Mare</b> Bidet cm 54 x 37 x 28 h pg. 391	<b>Catino</b> Wc senza brida Rimless wc cm 56 x 38 x 27 h pg. 134	<b>Catino</b> Bidet cm 56 x 38 x 27 h pg. 135	<b>Era</b> Wc senza brida Rimless wc cm 36,5 x 53 x 37 h pg. 406	<b>Era</b> Bidet cm 36,5 x 53 x 30 h pg. 407	<b>Shui comfort</b> Wc cm 37,5 x 55 x 37,5 h pg. 436	<b>Shui comfort</b> Wc senza brida Wc rimless cm 37,5 x 55 x 37,5 h pg. 436	<b>Shui comfort</b> Bidet cm 37,5 x 55 x 37,5 h pg. 437
								
<b>Le Giare</b> Wc cm 37 x 55 x h37,5 pg. 422	<b>Le Giare</b> Bidet cm 37 x 55 x 33,5 h pg. 423	<b>Smile 53</b> Wc cm 35 x 53 x 27 h pg. 466	<b>Smile 53</b> Wc senza brida Wc rimless cm 35 x 53 x 26,5 h pg. 466	<b>Smile 53</b> Bidet cm 35 x 53 x 27 h pg. 467	<b>Smile 48</b> Wc mini cm 35 x 48 x 26 h pg. 474	<b>Smile 48</b> Wc mini senza brida Wc mini rimless cm 35 x 48 x 26 h pg. 474	<b>Smile 48</b> Bidet mini cm 35 x 48 x 26 h pg. 475	
								
<b>Enjoy 53</b> Wc cm 35 x 53 x 26,5 h pg. 488	<b>Enjoy 53</b> Wc senza brida Wc rimless cm 35 x 53 x 26,5 h pg. 488	<b>Enjoy 53</b> Bidet cm 35 x 53 x 26,5 h pg. 489	<b>Enjoy 48</b> Wc mini senza brida Wc mini rimless cm 35 x 48 x 27 h pg. 492	<b>Enjoy 48</b> Bidet mini cm 35 x 48 x 27 h pg. 493	<b>Fluid</b> Wc cm 37 x 53 x 37 h pg. 502	<b>Fluid</b> Bidet cm 37 x 53 x 37 h pg. 503	<b>Shui</b> Wc cm 36 x 55 x 29 h pg. 452	<b>Shui</b> Bidet cm 36 x 55 x 29 h pg. 453

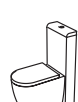

## Wc e bidet terra / Back to wall wc and bidet

								
<b>Mare</b> Wc senza brida Rimless wc cm 54 x 37 x 42 h pg. 392	<b>Mare</b> Bidet cm 54 x 37 x 42 h pg. 393	<b>Era</b> Wc senza brida Rimless wc cm 36,5 x 52 x 42 h pg. 408	<b>Era</b> Bidet cm 36,5 x 52 x 42 h pg. 409	<b>Shui comfort</b> Wc cm 38 x 55 x 44 h pg. 440	<b>Shui comfort</b> Wc scarico traslato Wc adjustable water inlet/outlet cm 38 x 55 x 44 h pg. 438	<b>Shui comfort</b> Bidet cm 38 x 55 x 44 h pg. 441	<b>Le Giare</b> Wc cm 37 x 55 x 42,5 h pg. 424	<b>Le Giare</b> Bidet cm 37 x 55 x 42,5 h pg. 425
								
<b>Smile 53</b> Wc cm 35 x 53 x 42 h pg. 468	<b>Smile 53</b> Wc senza brida Rimless wc cm 35 x 53 x 42 h pg. 468	<b>Smile 54</b> Wc scarico traslato Wc adjustable water inlet/outlet cm 35 x 54 x 42 h pg. 470	<b>Smile 53</b> Bidet cm 35 x 53 x 42 h pg. 469	<b>Smile 48</b> Wc mini scarico parete Wc mini with wall trap cm 35 x 48 x 42 h pg. 476	<b>Smile 48</b> Wc mini scarico terra Wc mini with floor trap cm 35 x 48 x 42 h pg. 476	<b>Smile 48</b> Bidet mini cm 35 x 48 x 42 h pg. 477	<b>Enjoy</b> Wc cm 35 x 53 x 42 h pg. 490	<b>Enjoy</b> Bidet cm 35 x 53 x 42 h pg. 491
								
<b>Fluid</b> Wc cm 37 x 53 x 41,5 h pg. 504	<b>Fluid</b> Bidet cm 37 x 53 x 41,5 h pg. 505	<b>Shui</b> Wc cm 36 x 55 x 43 h pg. 454	<b>Shui</b> Bidet cm 36 x 55 x 43 h pg. 455					

## Wc monoblocco / Monoblock wc

				
<b>Smile</b> Cassetta a terra Cistern on the floor cm 34 x 53 x 42 h + cm 36 x 14 x 92 h pg. 472	<b>Smile mini</b> Cassetta senza coperchio Cistern without lid cm 34 x 62 x 42 h + cm 34 x 14 x 42 h pg. 478	<b>Smile mini</b> Cassetta con coperchio Cistern with lid cm 34 x 62 x 42 h + cm 34 x 14 x 42 h pg. 478	<b>Fluid</b> Cassetta Cistern cm 37 x 68 x 41,5 h + cm 37 x 41 x 14 pg. 506	<b>Shui</b> Cassetta a terra Cistern on the floor cm 36 x 55 x 43 h + cm 36 x 14 x 98 h pg. 456

## Orinatoio / Urinals

	
<b>Mini ball</b> cm 66 X 30 x 70 h pg. 547	<b>Era</b> cm 49 X 39 x 66 h pg. 410

# Vasche da bagno \ Bath tubs

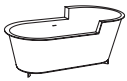

**Ofelia**  
Vasca freestanding  
Bath tub freestanding  
cm 157 x 93 x 69 h  
pg. 139



**Ottavia**  
Vasca freestanding  
Bath tub freestanding  
cm 170 x 80 x 56 h  
pg. 138



**Cibele**  
Vasca freestanding  
Bath tub freestanding  
cm 160 X 86 x 61 h  
pg. 338



**Cibele L**  
Vasca freestanding  
Bath tub freestanding  
cm 160 X 86 x 61 h  
pg. 339

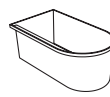

**Febe**  
Vasca freestanding  
Bath tub freestanding  
cm 140 X 80 x 57 h  
pg. 339



**Dafne**  
Vasca freestanding  
Bath tub freestanding  
cm 130 X 80 x 55 h  
pg. 339



**Shui comfort**  
Vasca freestanding  
Bath tub freestanding  
cm 170 X 87 x 53 h  
pg. 442



**Le Giare**  
Vasca freestanding  
Bath tub freestanding  
cm 190 X 119 x 60 h  
pg. 420

# Piatti doccia Shower trays

## I Catini

### piatto doccia Augusto in ceramica

Augusto ceramic shower tray  
cm 106 x 106 x 20 h  
pg. 140

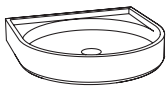

## Infinito H3

### piatto doccia in ceramica h3

h3 ceramic shower tray  
pg. 518

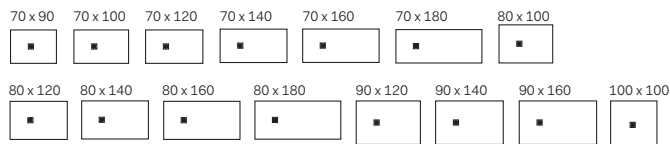
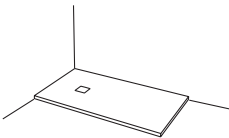

## Sessanta H6

### piatto doccia in ceramica h6

h6 ceramic shower tray  
pg. 528

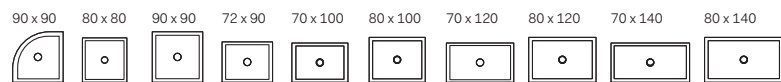
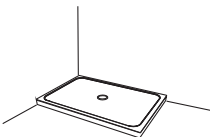

## Venticinque H2,5

### piatto doccia in marmogres h2,5

h2,5 ceramic shower tray  
pg. 536

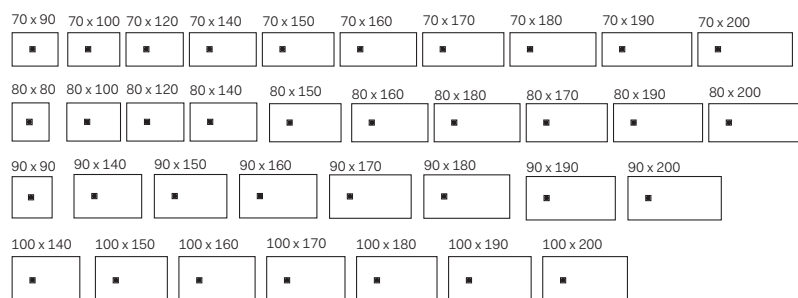

# Specchi Mirrors

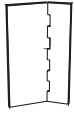

**Zip**  
cm 66 x 4,4 x 110 h  
pg. 342



**Pan**  
cm 74 x 18 x 110 h  
pg. 346



**Luc quadrato**  
con luce led  
destra - sinistra  
with right - left led light  
cm 40 x 6 x 40 h  
pg. 343



**Luc rettangolare**  
con luce led  
destra - sinistra  
with right - left led light  
cm 40 x 6 x 110 h  
pg. 343



**Specchio cinta h58**  
mirror with belt h 58  
cm Ø60 x 3,5  
pg. 153



**Specchio cinta h78**  
mirror with belt h 78  
cm Ø60 x 3,5  
pg. 153



**Specchio cinta h108**  
mirror with belt h 108  
cm Ø60 x 3,5  
pg. 153



**Theo Tondo 60**  
cm Ø60 x 3,5 h  
pg. 68



**Le giare**  
cm 62 X 2,5 x 87 h  
pg. 420



**Elle Tonda**  
cm 50 x 4 x 110 h  
pg. 238



**Elle Ovale**  
cm 70 x 4 x 110 h  
pg. 242



**Pluto**  
cm Ø40 x 30  
pg. 349



**Polifemo**  
cm 90 x 7 x 60 h  
pg. 349



**Argo**  
a parete / wall  
cm 40 x 5 x 95 h  
pg. 348



**Argo**  
a soffitto / ceiling  
cm 40 x 5 x 130/190 h  
pg. 348



**Eos**  
cm 67 x 4 x 107 h  
pg. 345



**Eos c**  
cm 67 x 12 x 107 h  
pg. 345



**Round 120**  
cm Ø120 x 4  
pg. 155



**Round 75**  
cm Ø75 x 4  
pg. 155



**Round 60**  
cm Ø60 x 4  
pg. 155



**Oval**  
cm 50 x 4 x 90 h  
pg. 155



**Alex**  
contenitore  
with storage unit  
cm 68 x 16,5 x 105 h  
pg. 342



**Zip**  
contenitore  
with storage unit  
cm 66 x 14 x 110 h  
pg. 342



**Theo Ovale Destro**  
contenitore /  
with storage unit  
cm 80 x 13 x 78 h  
pg. 68



**Theo Ovale Sinistro**  
contenitore /  
with storage unit  
cm 80 x 13 x 78 h  
pg. 68



**Theo Doppio**  
contenitore /  
with storage unit  
cm 167 x 13 x 78 h  
pg. 69



**Theo Rettangolare Sinistro**  
contenitore /  
with storage unit  
cm 74 x 12,5 x 100 h  
pg. 68



**Pan**  
Specchio +  
contenitore  
Mirror + storage unit  
cm 74 x 18 x 110 h  
cm 37 x 18 x 110 h  
pg. 347

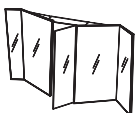

**Pan**  
Specchio + contenitore  
Mirror + storage unit  
cm 74 x 18 x 110 h  
cm 30 x 18 x 110 h  
pg. 347



**Elio**  
cm 50 x 31 x 140 h  
pg. 344



**Elio**  
bicolore / bicolor  
cm 50 x 31 x 140 h  
pg. 344



**Elio slim**  
cm 50 x 15 x 140 h  
pg. 344



**Elio slim**  
bicolore / bicolor  
cm 50 x 15 x 140 h  
pg. 344



**Simple tall box**  
cm 45 x 12 x 110 h  
pg. 345

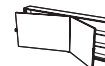

**Simple box**  
cm 90 x 12 x 45 h  
pg. 345



**Round box 90**  
cm Ø90 x 12  
pg. 155



**Round box 75**  
cm Ø75 x 12  
pg. 155



**Oval box**  
cm 50 x 12 x 90 h  
pg. 155



**Marcel**  
cm 68 x 13 x 100 h  
pg. 29

# Accessori e complementi

## Accessories and complements



**Bicchiere in metallo**  
Metal glass  
cm Ø6 x 11 h  
pg. 365



**Dispenser in metallo**  
Metal dispenser  
cm Ø6 x 18 h  
pg. 365



**Bicchiere in LivingTec**  
LivingTec Glass  
cm Ø7 x 11 h  
pg. 369



**Dispenser in LivingTec**  
LivingTec Dispenser  
cm Ø7 x 17 h  
pg. 369



**Porta rotolo**  
Roll holder  
cm 12 X 10 x 3 h  
pg. 366



**Porta rotolo**  
Roll holder  
cm 12 X 14 x 3 h  
pg. 369

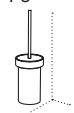

**Porta scopino sospeso**  
Wall-hung toilet brush  
cm Ø12 x 42 h  
pg. 366

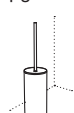

**Porta scopino da terra**  
Floor toilet brush  
cm Ø12 x 42 h  
pg. 367



**Porta scopino**  
Toilet brush holder  
cm 60 x 6 x 3 h  
pg. 370



**Gancio**  
Hook  
cm 4 x 2,5 x 2,5 h  
pg. 369



**Gancio 1**  
Hook 1  
cm 3 x 3 x 4,5 h  
pg. 365



**Gancio 2**  
Hook 2  
cm 3 x 3 x 4,5 h  
pg. 365



**Portasciugamani rettangolare 30**  
Rectangular towel rail 30  
cm 30 x 6 x 3 h  
pg. 362



**Portasciugamani rettangolare 45**  
Rectangular towel rail 45  
cm 45 x 6 x 3 h  
pg. 362



**Portasciugamani rettangolare 60**  
Rectangular towel rail 60  
cm 60 x 6 x 3 h  
pg. 362



**Portasciugamani ovale 30**  
Oval towel rail 30  
cm 30 x 6 x 3 h  
pg. 362



**Portasciugamani ovale 45**  
Oval towel rail 45  
cm 45 x 6 x 3 h  
pg. 362



**Portasciugamani ovale 60**  
Oval towel rail 60  
cm 60 x 6 x 3 h  
pg. 362



**Portasciugamani ad anello**  
Ring towel holder  
Ø32  
pg. 365



**Mensola Tonda**  
Round shelf  
cm Ø 12 x 3 h  
pg. 364



**Mensola Ovale**  
Oval shelf  
cm 25 x 12 x 3 h  
pg. 364



**Barra porta accessori 12**  
Tray for accessories  
cm 12 x 12 x 3 h  
pg. 368



**Barra porta accessori 30**  
Tray for accessories  
cm 30 x 12 x 3 h  
pg. 368



**Barra porta accessori 45**  
Tray for accessories  
cm 50 x 12 x 3 h  
pg. 368



**Barra porta accessori 72**  
Tray for accessories  
cm 72 x 12 x 3 h  
pg. 368



**Mensola 12**  
Shelf 12  
cm 12 x 12 x 3 h  
pg. 368



**Mensola 30**  
Shelf 30  
cm 30 x 12 x 3 h  
pg. 368



**Mensola 50**  
Shelf 50  
cm 50 x 12 x 3 h  
pg. 368



**Mensola 72**  
Shelf 72  
cm 72 x 12 x 3 h  
pg. 368



**Porta sapone**  
Soap holder  
cm 12 x 12 x 3 h  
pg. 368



**Porta sapone**  
Soap holder  
cm 30 x 12 x 3 h  
pg. 368



**Porta sapone con foro**  
per bicchiere o dispenser  
Soap holder with hole for  
glass or dispenser  
cm 30 x 12 x 2 h  
pg. 368



**Porta bicchiere o dispenser**  
Glass or dispenser holder  
cm 12 x 12 x 2 h  
pg. 368



**Porta bicchiere o dispenser**  
Glass or dispenser holder  
cm 30 x 12 x 2 h  
pg. 368



**Sacca portaoggetti**  
Siwa da muro, in cuoio  
Siwa wall-hung leather  
storage bag  
cm 60 x 90 h  
pg. 213

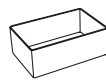

**Cesta Plinio in cuoio h28**  
Basket in leather h28  
Plinio  
cm 63 x 36 x 28 h  
pg. 269

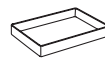

**Cesta Plinio in cuoio h10**  
Basket in leather h10  
Plinio  
cm 63 x 36 x 10 h  
pg. 269



**Sacca portabiancheria**  
Narciso in cuoio  
Laundry bag Narciso in  
real leather  
cm 45 x 14 x 50 h  
pg. 316



**Cassettiera Luisa**  
componibile  
Modular drawer unit  
cm 34 x 40 x 20 h  
cm 34 x 40 x 34 h  
pg. 356



**Otto Ovale**  
Pouf ovale contenitore in  
legno con coperchio in  
legno, su ruote  
Oval wooden pouf cabinet  
with wooden lid, on 4  
wheels  
cm 60 x 38 x 43 h  
pg. 240



**Otto Tondo**  
pouf contenitore in  
Livingtec su 4 ruote  
Round pouf cabinet in  
LivingTec on 4 wheels  
cm Ø 40 x 43 h  
pg. 236



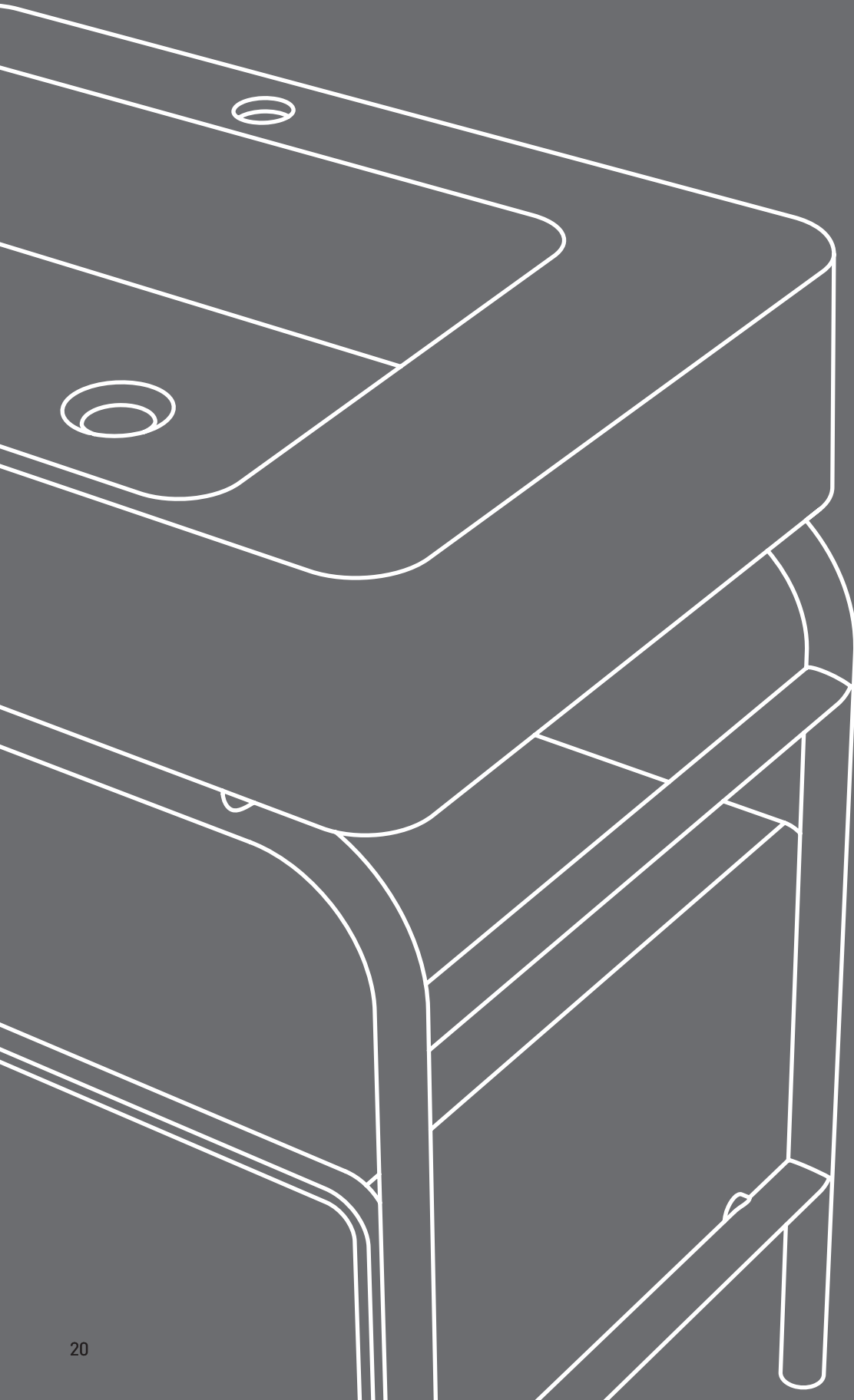

# Marcel

design **Andrea Parisio & Giuseppe Pezzano**

QR code configuratore \ configuratore pg. 24

indice collezione \ collection index pg. 25

moduli d'ordine \ order form pg. 27

listino prezzi \ price list pg. 28 - 29







## Configure the product directly online and send the order to Cielo.

Configure el producto directamente online y envíe el pedido a Cielo.

Configurez le produit directement en ligne et envoyez la commande à Cielo.

Konfigurieren Sie Ihr Produkt online und schicken Sie die Bestellung direkt an Cielo.

Сконфигурируйте изделие в онлайн и перешлите заказ на фабрику Cielo.

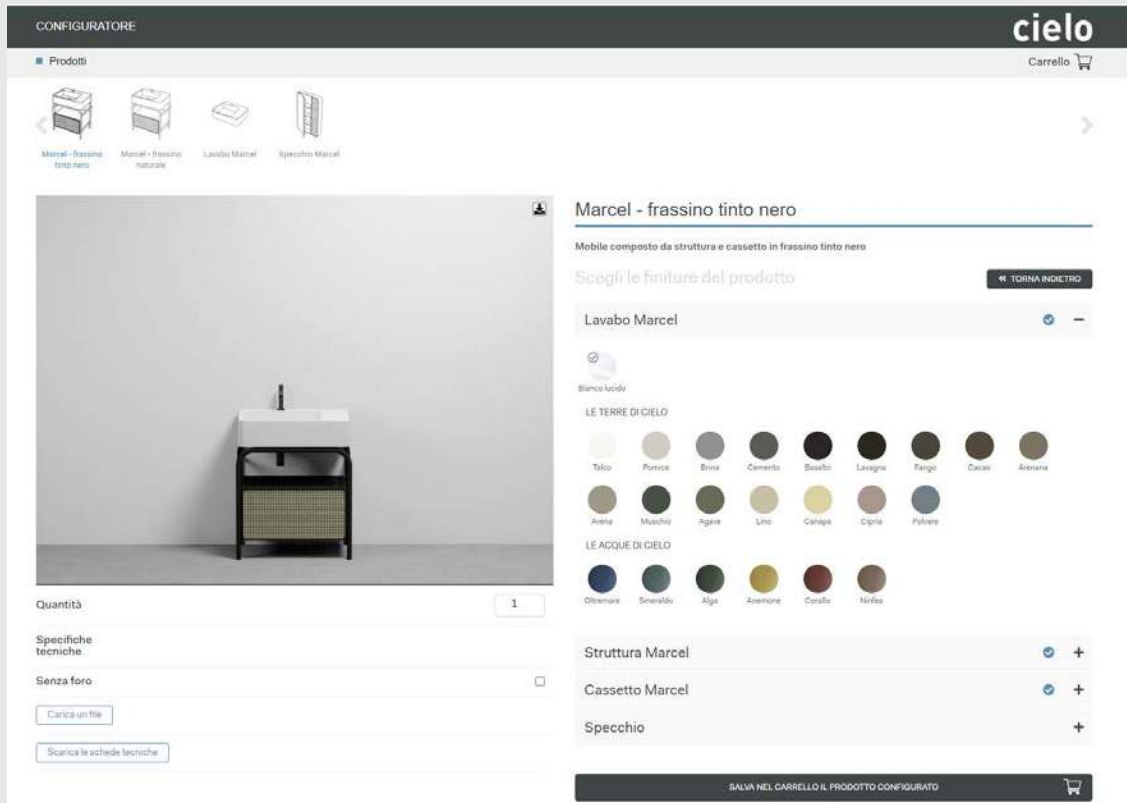

EN



go to the  
configurator

SP



ir al  
configurador

FR



lien vers le  
configurateur

RU



Перейдите в  
конфигуратор

## Lavabo / washbasin

installazione sospesa o da piano  
wall-hung or on top installation

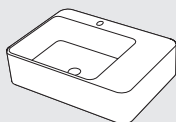

### MALA

70 x 50 x h 17  
pg. 28

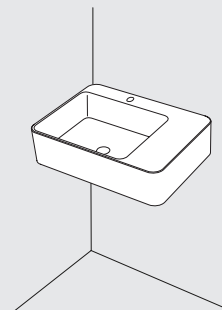
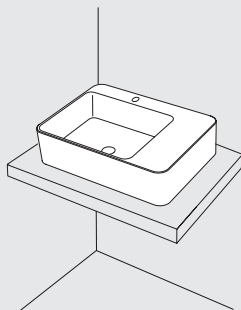

## Washbasin with cabinet / Lavabo con mobile

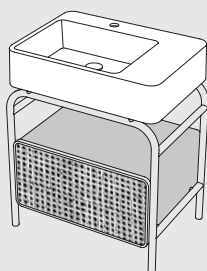

### Marcel

72 x 50  
pg. 28

## Specchio / mirror

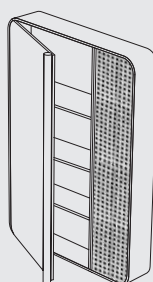

### MASPRE

68 x 100 x 13  
pg. 29

The possible variations of the colour cannot be considered as defect, but as a guarantee of the completely artisan manufacturing of this unique and high quality product. / Las variaciones de colores no se consideran un defecto sino una garantía de una elaboración manual y artesanal en un producto único y de calidad. / Les éventuelles variations de couleur ne peuvent être considérées comme des défauts, elles témoignent en revanche d'une méthode de travail totalement manuelle et artisanale employée pour obtenir un produit fini unique et de qualité. / Eventuelle Farbvariationen sind nicht als Mangel anzusehen, sondern als Garantie für die komplett handwerkliche Anfertigung eines einzigartigen und hochqualitativen Produkts. / Возможные вариации цвета не могут считаться дефектом, а являются подтверждением ручной работы, гарантией качества и уникальности изделия.

modelli disponibili / available models

## MARCEL

collection

### Marcel

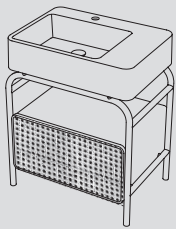

Marcel  
72 x 50 x 87 h



Marcel  
finitura lavabo /  
washbasin finish talco  
finitura mobile /  
cabinet finish frassino  
tinto nero

### finiture / finishes

**LAVABO IN CERAMICA / CERAMIC WASHBASIN**

**Le Terre di Cielo**

MALA

Talco Pomice Brina Basalto Lavagna Cemento Fango Cacao Arenaria Avena Lino Agave Muschio Polvere Cipria Canapa

Bianco Lucido  
Gloss White

**Le Acque di Cielo**

MALASF

Oltremare Smeraldo Alga Corallo Ninfea Anemone

### STRUTTURA IN LEGNO DI FRASSINO / STRUCTURE IN STAINED SOLID ASH WOOD

essenza / wood



MASTE



### CASSETTO IN LEGNO DI FRASSINO CON FRONTE IN PAGLIA DI VIENNA NATURALE / DRAWER IN STAINED SOLID IN ASH WOOD, WITH THE FRONT IN NATURAL VIENNA STRAW

essenza / wood

frontale / frontal

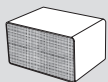

MACE



### note tecniche lavabo / washbasin technical notes

senza foro su richiesta  
no tap hole on request

monoforo predisposto 3 fori  
with 1 hole prepared 3 holes version

senza troppopieno  
without overflow

con un lato non smaltato  
one side is unglazed

installazione sospesa  
wall-hung installation

installazione da piano  
on top installation

ATTENZIONE: obbligo struttura + lavabo + cassetto  
PLEASE NOTE: mandatory framework + washbasin + drawer



CLIENTE/client:

ORD. REF.:

QUANTITÀ /quantity:

EMAIL:

**INDICARE CON UN SEGNO LE FINITURE SCELTE PER I DIVERSI COMPONENTI**

*INDICATE WITH A TICK, THE CHOOSEN FINISHES FOR ALL THE COMPONENTS*

art. **MALA \ MALASF**

**FINITURE LAVABO**

WASHBASIN SHELF FINISHES

Bianco/white - glossy

Le Terre di Cielo

- |                                    |                                     |
|------------------------------------|-------------------------------------|
| <input type="radio"/> TL - Talco   | <input type="radio"/> AN - Arenaria |
| <input type="radio"/> PM - Pomice  | <input type="radio"/> AV - Avena    |
| <input type="radio"/> BR - Brina   | <input type="radio"/> LN - Lino     |
| <input type="radio"/> BA - Basalto | <input type="radio"/> AG - Agave    |
| <input type="radio"/> LV - Lavagna | <input type="radio"/> MU - Muschio  |
| <input type="radio"/> CM - Cemento | <input type="radio"/> PL - Polvere  |
| <input type="radio"/> FN - Fango   | <input type="radio"/> CP - Cipria   |
| <input type="radio"/> CA - Cacao   | <input type="radio"/> CN - Canapa   |

Le Acque di Cielo

- |                                      |
|--------------------------------------|
| <input type="radio"/> OL - Oltremare |
| <input type="radio"/> SM - Smeraldo  |
| <input type="radio"/> AL - Alga      |
| <input type="radio"/> CO - Corallo   |
| <input type="radio"/> NI - Ninfea    |
| <input type="radio"/> AM - Anemone   |

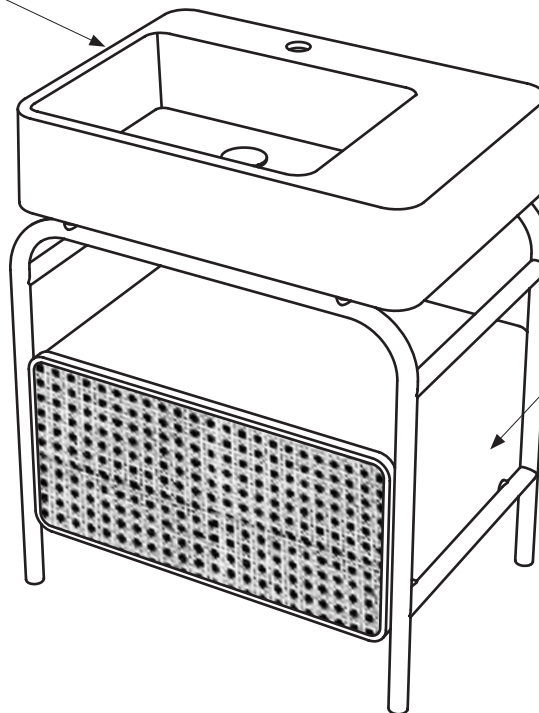

art. **MASTE**

**FINITURE STRUTTURA IN LEGNO**  
**MASSELLO**

SOLID WOOD FRAMEWORK FINISHES

essenze legno/wood essences

- |  |
|--|
| <input type="radio"/> NA - Frassino naturale   |
| <input type="radio"/> NM - Frassino tinto nero |

art. **MACE**

**FINITURE CASSETTO IN LEGNO**

DRAWER WOODEN FINISHES

essenze legno/wood essences

- |   |
|---|
| <input type="radio"/> NA - Frassino naturale  |
| <input type="radio"/> NM - Frassino tinto nero  |
| +   |
| <input type="radio"/> frontale in paglia di Vienna Naturale / front in natural Vienna straw |

**N.B.**  
**Il lavabo è monoforo predisposto 3 fori, su richiesta può essere prodotto senza foro.**  
**Gli elementi di fissaggio sono sempre neri in tutte le versioni.**

*N.B.*  
*The washbasin has 1 hole prepared 3 holes ; may be made without holes upon request.*  
*The fixing elements are always black in all versions.*

**DATA**  
DATE

**FIRMA DEL CLIENTE**  
SIGNATURE

ATTENZIONE:  
La rappresentazione delle finiture è puramente indicativa. Verificare le finiture con le relative cartelle.

*ATTENTION:*  
*The representation of the finishes is merely indicative. Please choose the finishes using the folders.*











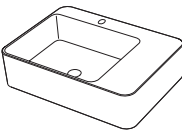

Ogni oggetto possiede la peculiarità di essere elaborato secondo principi puramente tradizionali, in modo da garantirne l'assoluta originalità ed unicità. Le eventuali piccole variazioni di colore, tono o venature fra gli articoli sono da considerarsi pregi e non difetti, in quanto garanzia della fattura manuale del prodotto, che fa di ogni oggetto Cielo un pezzo unico ed esclusivo, lontano dall'omologazione industriale. In fase d'ordine si intendono, pertanto, accettate tali tolleranze che non possono dare adito a contestazioni di alcun genere.

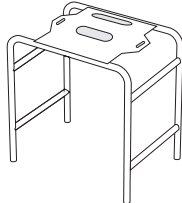
*Every item possesses that particular feature of being processed according to purely traditional principles that guarantee its absolute originality and uniqueness. The small variations in colour, hues or streaks on the items are to be considered as qualities and not defects, since they warranty the handcrafted processing which makes each Cielo item a unique and exclusive piece that cannot be compared to industrial standardization. When making the order, the client implicitly accepts those various features that may give rise to claims of any sort.*

Verificare sempre le disponibilità e i tempi di consegna con il commerciale.

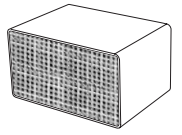
*Always check the availability and delivery time with the commercial department.*









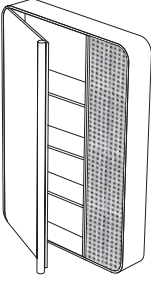

	Size (cm) Medidas Dimensions Maße Размеры	Product code Artículo Article Artikel Артикул	Net weight (Kg) Peso neto Poids net Reingewicht вес нетто	Finishes Acabados Finitions Farbe Отделки	Euro Евро	Pz. шт. pallet Italia	Pz. шт. pallet Cont.
 <p><b>Ceramic washbasin with 1 hole</b> Lavabo de cerámica monoagujero \ Lavabo en céramique avec un trou \ Waschbecken aus Keramik mit 1 Hahnloch \ Керамическая раковина на одно отверстие</p>	70 x 50 x h17	MALA(X)* MALASF(X)* <b>no tap hole sin agujero sans orifice ohne Loch без отверстия</b>	27,00	 Glossy White  Le Terre di Cielo  Le Acque di Cielo	808,00 1124,00 1124,00		
<p><b>For on top installation customers are advised to the require the "RETTIFICA" option</b> Para instalaciones de apoyo se aconseja usar la opción "RETTIFICA" / Pour l'installation à poser on conseille l'option "RETTIFICA" / Bei Aufsatzmontage bitte die Option "RETTIFICA" anfragen / При установке на столешницу рекомендуется запросить опцию "RETTIFICA"</p>		RETTIFICA GRINDING			10,00		
 <p><b>Structure in natural or black stained solid Ash wood</b> Estructura de fresno macizo natural o teñido de negro / Structure en bois massif de frêne naturel ou teinté noir / Struktur aus Massivholz Esche natur oder schwarz lackiert / Структура из массива ясеня в отделке натуральный или крашеный в черный цвет</p>	72 x 50 x h70	MASTE(X)*	23,00	 NA - Frassino naturale  NM - Frassino tinto nero  <p><b>PLEASE NOTE: The frame and the drawer must be ordered in the same colour.</b> ATENCIÓN: la estructura y el cajón deben pedirse obligatoriamente en el mismo acabado. ATTENTION: la structure et le tiroir doivent être obligatoirement commandé dans la même finition. ACHTUNG: Gestell und Schubkasten müssen immer in derselben Farbe bestellt werden. ВНИМАНИЕ: структуру и ящик необходимо обязательно заказывать в одинаковых цветах.</p>	1417,00 1417,00		
 <p><b>Drawer in natural or black stained Ash wood, with the front in natural Vienna straw</b> Cajón de fresno natural o teñido de negro, con frente de paja de Viena natural / Tiroir en frêne naturel ou teinté noir, avec façade en paille de Vienne naturelle / Schublade aus Eschenholz natur oder schwarz lackiert, mit Frontblende / Ящик из ясеня в отделке натуральный или крашеный в черный цвет. Фасад из венской соломы в отделке натуральная</p>	65 x 50 x h33	MACE(X)*	8,00	 NA - Frassino naturale  NM - Frassino tinto nero  <p><b>PLEASE NOTE: The frame and the drawer must be ordered in the same colour.</b> ATENCIÓN: la estructura y el cajón deben pedirse obligatoriamente en el mismo acabado. ATTENTION: la structure et le tiroir doivent être obligatoirement commandé dans la même finition. ACHTUNG: Gestell und Schubkasten müssen immer in derselben Farbe bestellt werden. ВНИМАНИЕ: структуру и ящик необходимо обязательно заказывать в одинаковых цветах.</p>	2068,00 2068,00		

**PLEASE NOTE: mandatory framework + washbasin + drawer**





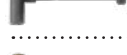

 obligatorio estructura + lavabo + cajón  
obligatoire structure + vasque + tiroir  
obligatorisch Struktur + Waschbecken + Schublade  
обязательно конструкция + умывальник + выдвижной ящик

- Le Terre di Cielo  TL - Talco  PM - Pomice  BR - Brina  BA - Basalto  LV - Lavagna  CM - Cemento  FN - Fango  CA - Cacao
-  AN - Arenaria  AV - Avena  LN - Lino  AG - Agave  MU - Muschio  PL - Polvere  CP - Cipria  CN - Canapa
- Le Acque di Cielo  OL - Oltremare  SM - Smeraldo  AL - Alga  CO - Corallo  NI - Ninfea  AM - Anemone

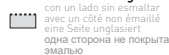
	Size (cm) Medidas Dimensions Maße Размеры	Product code Artículo Article Artikel Артикул	Net weight (kg) Peso neto Poids net Reingewicht вес нетто	Finishes Acabados Finitions Farbe Отделка	Euro Евро
 <p><b>Rectangular mirror cabinet, with double door, with natural or black stained solid Ash wood frame and front right door in natural Vienna straw</b> / Espejo contenedor rectangular, con puerta doble, con borde en madera de fresno macizo natural o teñido de negro y puerta delantera derecha en paja de Viena natural / Miroir de rangement rectangulaire, à double porte, avec structure en de frêne naturel ou teinté noir et façade droite en paille de Vienne naturelle / Rechteckiger Spiegelschrank, mit Doppeltür, mit Korpus aus Esche natur oder schwarz lackiert, mit rechter Frontblende aus Wiener Geflecht natur / Прямоугольный зеркальный шкафчик, с двойной дверью. Корпус из ясеня в отделке натуральный и передней правой дверцей из венской соломы в отделке натуральная</p>	68 x 100 x 13	MASPRE(x)*	29,00	<ul style="list-style-type: none"> <li><span style="display: inline-block; width: 10px; height: 10px; background-color: #c0c0c0; border-radius: 50%; margin-right: 5px;"></span> NA - Frassino naturale</li> <li><span style="display: inline-block; width: 10px; height: 10px; background-color: #333333; border-radius: 50%; margin-right: 5px;"></span> NM - Frassino tinto nero</li> </ul>	2851,00
				2851,00	

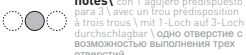
 <p><b>Universal click/clack drain in CHROME with ceramic lid</b> Válvula universal click/clack Cromado con tapa en cerámica \ Bonde universelle clic/clac Chromé avec clapet en céramique \ Universal-Abflussgarnitur Click-Clack Chrom mit Keramikstopfen \ Универсальный донный клапан click/clack хром с керамической крышкой</p>	PIL01(x)*	0,40	<ul style="list-style-type: none"> <li><span style="display: inline-block; width: 10px; height: 10px; background-color: #c0c0c0; border-radius: 50%; margin-right: 5px;"></span> Gloss White</li> <li><span style="display: inline-block; width: 10px; height: 10px; background-color: #808080; border-radius: 50%; margin-right: 5px;"></span> Le Terre di Cielo</li> <li><span style="display: inline-block; width: 10px; height: 10px; background-color: #008080; border-radius: 50%; margin-right: 5px;"></span> Le Acque di Cielo</li> </ul>	95,00 139,00 139,00
 <p><b>Universal click/clack drain in BLACK MATT finish with ceramic lid</b> Válvula universal click/clack Negro Matt con tapa en cerámica \ Bonde universelle clic/clac Noir Matt avec clapet en céramique \ Universal-Abflussgarnitur Click-Clack Matt Schwarz mit Keramikstopfen \ Универсальный донный клапан click/clack черный матовый с керамической крышкой</p>	PIL01NM(x)*	0,40	<ul style="list-style-type: none"> <li><span style="display: inline-block; width: 10px; height: 10px; background-color: #c0c0c0; border-radius: 50%; margin-right: 5px;"></span> Gloss White</li> <li><span style="display: inline-block; width: 10px; height: 10px; background-color: #808080; border-radius: 50%; margin-right: 5px;"></span> Le Terre di Cielo</li> <li><span style="display: inline-block; width: 10px; height: 10px; background-color: #008080; border-radius: 50%; margin-right: 5px;"></span> Le Acque di Cielo</li> </ul>	120,00 169,00 169,00
 <p><b>Universal click/clack drain in CEMENTO finish with ceramic lid</b> Válvula universal click/clack Cemento con tapa en cerámica \ Bonde universelle clic/clac Cemento avec clapet en céramique \ Universal-Abflussgarnitur Click-Clack Cement mit Keramikstopfen \ Универсальный донный Cemento click/clack с керамической крышкой</p>	PIL01CM(x)*	0,40	<ul style="list-style-type: none"> <li><span style="display: inline-block; width: 10px; height: 10px; background-color: #c0c0c0; border-radius: 50%; margin-right: 5px;"></span> Gloss White</li> <li><span style="display: inline-block; width: 10px; height: 10px; background-color: #808080; border-radius: 50%; margin-right: 5px;"></span> Le Terre di Cielo</li> <li><span style="display: inline-block; width: 10px; height: 10px; background-color: #008080; border-radius: 50%; margin-right: 5px;"></span> Le Acque di Cielo</li> </ul>	120,00 169,00 169,00
 <p><b>Universal click/clack drain in BRONZE with ceramic lid</b> Válvula universal click/clack Bronce con tapa en cerámica \ Bonde universelle clic/clac Bronze avec clapet en céramique \ Universal-Abflussgarnitur Click-Clack Bronze mit Keramikstopfen \ Универсальный донный клапан click/clack бронза с керамической крышкой</p>	PIL01BR(x)*	0,40	<ul style="list-style-type: none"> <li><span style="display: inline-block; width: 10px; height: 10px; background-color: #c0c0c0; border-radius: 50%; margin-right: 5px;"></span> Gloss White</li> <li><span style="display: inline-block; width: 10px; height: 10px; background-color: #808080; border-radius: 50%; margin-right: 5px;"></span> Le Terre di Cielo</li> <li><span style="display: inline-block; width: 10px; height: 10px; background-color: #008080; border-radius: 50%; margin-right: 5px;"></span> Le Acque di Cielo</li> </ul>	135,00 182,00 182,00
 <p><b>CHROMED siphon</b> Sifone Cromado \ Siphon Chromé \ Siphon Verchromt \ сифон Chrome</p>	SISP	0,93	<ul style="list-style-type: none"> <li><span style="display: inline-block; width: 10px; height: 10px; background-color: #808080; border-radius: 50%; margin-right: 5px;"></span> Chrome</li> </ul>	133,00
 <p><b>MATT BLACK siphon</b> Sifone Negro Mate \ Siphon Noir Mat \ Siphon Schwarz Matt \ Сифон Черный матовый</p>	SIFN	0,93	<ul style="list-style-type: none"> <li><span style="display: inline-block; width: 10px; height: 10px; background-color: #333333; border-radius: 50%; margin-right: 5px;"></span> Matt Black</li> </ul>	194,00
 <p><b>CEMENTO siphon</b> Sifone Cemento \ Siphon Cemento \ Siphon Cemento \ сифон Cemento</p>	SIFCM	0,93	<ul style="list-style-type: none"> <li><span style="display: inline-block; width: 10px; height: 10px; background-color: #808080; border-radius: 50%; margin-right: 5px;"></span> Cemento</li> </ul>	194,00
 <p><b>BRONZE siphon</b> Sifone Bronce \ Siphon Bronze \ Siphon Bronze \ бронза сифон</p>	SIFBR	0,93	<ul style="list-style-type: none"> <li><span style="display: inline-block; width: 10px; height: 10px; background-color: #c08040; border-radius: 50%; margin-right: 5px;"></span> Bronze</li> </ul>	220,00

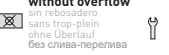
Technical symbols legend / Símbolos técnicos clave / Légende symboles techniques / Technische Zeichenerklärung / Перечень технических символов

 <p>one side is unglazed con un lado sin esmaltar avec un côté non émaillé eine Seite unglasiert одна сторона не покрыта эмалью</p>	 <p>wall-hung installation instalación suspendida installation suspendue wandhängende Montage подвесная установка</p>	 <p>on top installation instalación de apoyo installation à partir du plan Montage auf Platte установка на столешницу</p>	 <p>with 1 hole prepared 3 holes con 1 agujero preparado 3 agujeros à trois trous \ mit 1-Loch auf 3-Loch durchschlagen \ одно отверстие с возможностью выполнения трех отверстий</p>	 <p>no tap hole on request sin agujero, solo a petición sans orifice sur demande auf Anfrage ohne Loch без отверстия под смеситель по запросу</p>	 <p>without overflow sin rebosadero sans trop-plein ohne Überlauf без слива-перелива</p>	 <p>with fixing parts fijaciones incluidas fixations incluses inklusive Befestigungen в комплекте с крепежами</p>
---	--	--	--	---	---	--

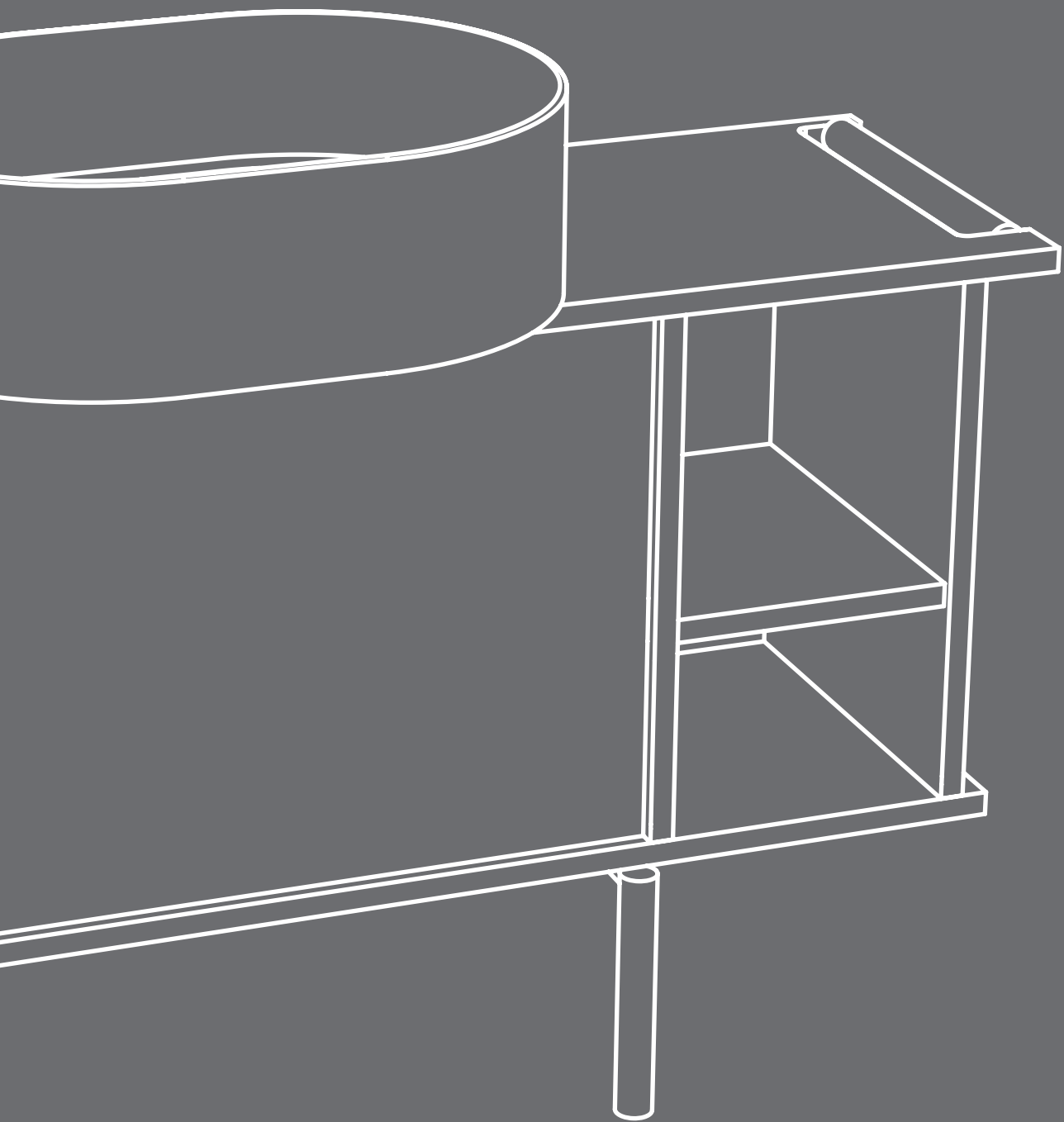

# Theo

design **Andrea Parisio & Giuseppe Pezzano**

QR code configuratore \ configurator pg. 34

indice collezione \ collection index pg. 35

moduli d'ordine \ order form pg. 39 - 51

listino prezzi \ price list pg. 53 - 69







## Configure the product directly online and send the order to Cielo.

Configure el producto directamente online y envíe el pedido a Cielo.  
 Configurez le produit directement en ligne et envoyez la commande à Cielo.  
 Konfigurieren Sie Ihr Produkt online und schicken Sie die Bestellung direkt an Cielo.  
 Сконфигурируйте изделие в онлайн и перешлите заказ на фабрику Cielo.

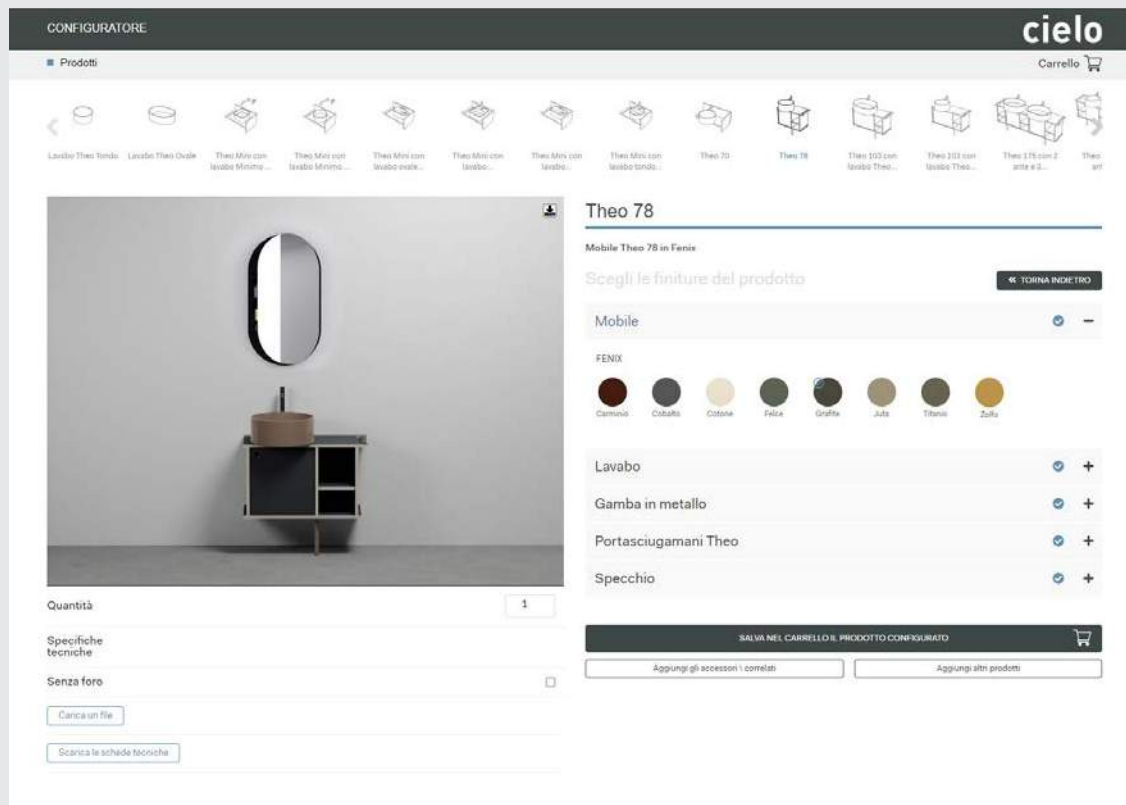

EN



go to the  
configurator

SP



ir al  
configurador

FR



lien vers le  
configurateur

RU



Перейдите в  
конфигуратор

## Lavabi / washbasins



**THLAT**  
ø40 x 16 h  
pag. 53



**THLAO**  
55 x 40 x 16 h  
pag. 53

## Lavabi con mobile / washbasins with cabinet

**Theo Mini**

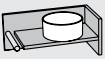

55,5 x 31 x 24 h  
pag. 54

**Theo 70**

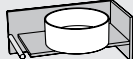

72,5 x 38 x 29 h  
pag. 56

**Theo 78**

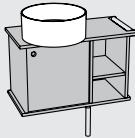

78 x 38 x 47 h  
pag. 58

**Theo 103**

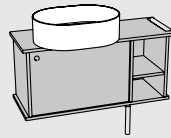

103 x 38 x 47 h  
pag. 60

**Theo 175 con 4 ante e un vano giorno**

Cabinet with 4 doors and a day compartment

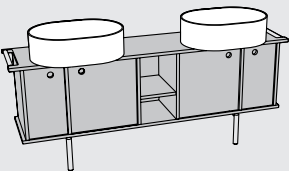

175 x 38 x 47 h  
pag. 62

**Theo 175 con 2 ante e 3 vani giorno**

Cabinet with 2 doors and 3 day compartments

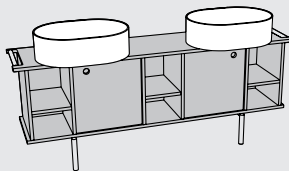

175 x 38 x 47 h  
pag. 64

**Theo 175 con 2 cassettoni e un vano giorno**

Cabinet with 2 drawers and a day compartment

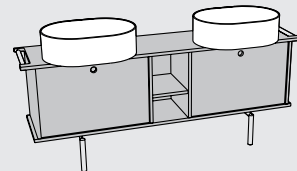

175 x 38 x 47 h  
pag. 66

## Specchi / mirrors

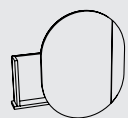

**Theo right mirror**

**THSPDX**  
80 x 13 x 78 h  
pag. 68

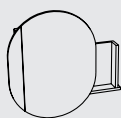

**Theo left mirror**

**THSPSX**  
80 x 13 x 78 h  
pag. 68

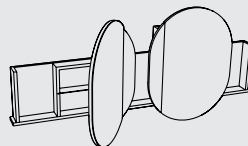

**Theo mirror double**

pag. 69

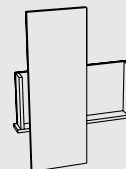

**Rectangular mirror Theo**

**THSPR**  
74 x 12,5 x 100 h  
pag. 68



**Round mirror Theo 60**

**THSPT60**  
60 x 3,5 x 60 h  
pag. 68



## TECHNOLOGY REVOLUTIONISES DESIGN

FENIX is an innovative material consisting of 60% paper and 40% resins. It is manufactured through a special process in which heat and pressure are applied simultaneously in order to obtain a homogenous, non-porous product. The surface is extremely opaque, anti-fingerprint and pleasantly soft to the touch. Thanks to the nanotechnology applied to FENIX, there is superior resistance to surface scratches and abrasion. The high resistance properties of FENIX are achieved by the use of very small particles (nanoparticles) that are not visible to the naked eye. Through a high-tech production process, the nanoparticles are uniformly distributed and incorporated into the surface coating of FENIX. A phenolic birch plywood panel, double-sided coated in FENIX with visible edges with transparent matt varnish. The decision to leave the plywood visible, in addition to characterising it from an aesthetic point of view, guarantees greater resistance.

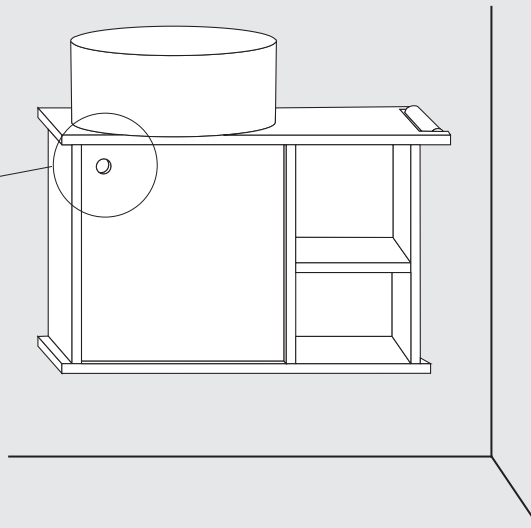

### LA TECNOLOGÍA REVOLUCIONA EL DISEÑO

FENIX es un material innovador compuesto por un 60% de papel y un 40% de resinas. Se elabora mediante un proceso particular en el que se aplica simultáneamente calor y presión para obtener un producto homogéneo y no poroso. La superficie es extremadamente opaca y antihuellas, agradable y suave al tacto. Gracias a la nanotecnología aplicada a FENIX se crea una resistencia superior a los arañazos superficiales y abrasión. Las propiedades de alta resistencia de FENIX se obtienen gracias al uso de partículas muy pequeñas (nanopartículas) que no son visibles a simple vista. A través de un proceso de producción altamente tecnológico, las nanopartículas se distribuyen uniformemente y se incorporan al revestimiento superficial de FENIX. Panel contrachapado fenólico de abedul, revestido a doble cara en Fenix con cantos vistos con barniz transparente mate. La elección de dejar el contrachapado expuesto, además de caracterizar desde el punto de vista estético el producto, garantiza una mayor resistencia al mismo.

### LA TECHNOLOGIE RÉVOLUTIONNE LE DESIGN

FENIX est un matériau innovant composé à 60 % de papier et à 40 % de résines. Il résulte d'un procédé particulier par lequel la chaleur et la pression sont appliquées simultanément afin d'obtenir un produit homogène et non poreux. La surface est extrêmement mate, anti-traces de doigts et agréablement douce au toucher. La nanotechnologie dont FENIX fait l'objet assure une meilleure résistance aux rayures de surface et à l'abrasion. Les propriétés de haute résistance de FENIX dépendent de l'utilisation de très petites particules (nanoparticules), qui ne sont pas visibles à l'œil nu. Grâce à un procédé de fabrication de haute technologie, les nanoparticules sont uniformément réparties et incorporées dans le revêtement de surface de FENIX. Panneau en contreplaqué phénolique de bouleau, revêtu sur les deux faces en Fenix et bords visibles en vernis mat transparent. La décision de laisser le contreplaqué apparent caractérise le produit d'un point de vue esthétique, mais cela garantit également une plus grande résistance à l'usure.

### TECHNOLOGIE - REVOLUTION DES DESIGNS

FENIX ist ein innovatives Material, mit einem Anteil von 60 % Papier und 40 % Kunstharz. Es entsteht durch einen speziellen Fertigungsprozess, bei dem durch die gleichzeitige Einwirkung von Wärme und die Ausübung von Druck ein homogenes, nicht poröses Produkt entsteht. Seine Oberfläche besitzt eine extrem matte Ausführung, auf der keine Fingerabdrücke sichtbar bleiben und zeichnet sich gleichzeitig durch eine angenehm weiche Haptik aus. Dank der eingesetzten Nanotechnologie ist FENIX außerdem hoch-beständig gegenüber Kratzern auf der Oberfläche und Abrieb. Die ausgeprägte Robustheit von FENIX wird durch den Einsatz besonders kleiner Elemente, sogenannter „Nanopartikel“ erzielt – so klein, dass sie mit bloßem Auge nicht sichtbar sind. Mit Hilfe eines hochtechnologischen Fertigungsprozesses werden sie gleichmäßig verteilt und in die Oberflächenbeschichtung von FENIX integriert. Birken-Multiplexplatte mit Phenolharz, beidseitig mit Fenix beschichtet, naturbelassene Kanten mit matt-transparenter Lackierung. Die Entscheidung, das Multiplexholz sichtbar zu lassen charakterisiert das Produkt nicht nur optisch, sondern verbessert gleichzeitig auch seine Beständigkeit.

### Технологии

#### революционируют дизайн

FENIX – это инновационный материал, состоящий на 60% из бумаги и на 40% из смолы. Данный материал производится в результате особого процесса, при котором одновременно применяются тепло и давление для получения однородного и непористого продукта. Поверхность материала совершенно матовая, приятная на ощупь и на ней не остаются отпечатки. Благодаря нанотехнологиям, применяемым в материале FENIX, поверхность отличается превосходной устойчивостью к царапинам и стиранию. Высокая устойчивость FENIX достигается за счет использования очень мелких частиц (наночастиц), невидимых невооруженным глазом. Благодаря высокотехнологичному производственному процессу наночастицы равномерно распределяются и включаются в поверхностное покрытие FENIX. Панели из березовой фанеры с двухсторонним покрытием Fenix и матовым прозрачным лаком, с незакрытой кромкой. Незакрытая кромка помимо эстетического эффекта гарантирует большую устойчивость материала.

## FINISHES

For Theo we have selected a range of FENIX colours that perfectly match our ceramic finishes, creating multiple customisation possibilities. The metal components (optional legs and towel rails) can be made in matt black, Cemento or the glossy colours of the Acque di Cielo, creating unlimited chromatic effects with the ceramic washbasin and cabinet.

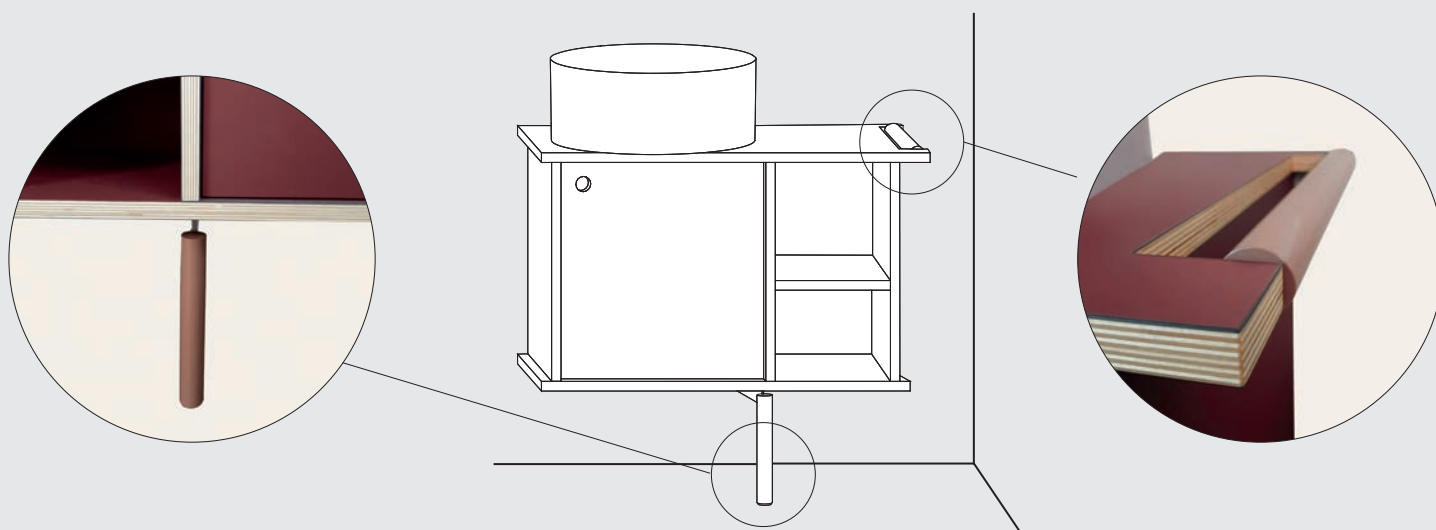
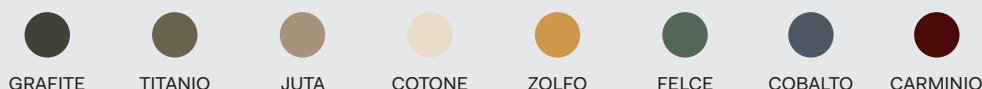

### LOS ACABADOS

Para Theo hemos seleccionado una gama de colores FENIX que combinan a la perfección con nuestros acabados cerámicos, creando múltiples posibilidades de personalización. Los componentes metálicos (patas y toallero) se pueden realizar en Negro mate, Cemento, Talco o en los colores brillantes de Acque di Cielo, creando efectos ilimitados cromático entre el lavabo de cerámica y el mueble.

### LES FINITIONS

Pour Theo, nous avons sélectionné une gamme de couleurs FENIX qui s'harmonisent parfaitement avec nos finitions céramiques et créent ainsi de multiples possibilités de personnalisation. Les éléments métalliques (pieds et porte-serviettes) peuvent être réalisés dans les finitions Nero Matt, Cemento, Talco ou dans les couleurs brillantes de la palette Acque di Cielo et créer ainsi des jeux de couleurs illimités avec le lavabo en céramique et le meuble.

### AUSFÜHRUNGEN

Die FENIX-Farbpalette die wir für Theo gewählt haben, harmoniert perfekt mit den Ausführungen unserer Keramiken und bietet eine große Vielfalt an individuellen Gestaltungsmöglichkeiten. Die Elemente aus Metall (Beine und Handtuchhalter) sind in den Ausführungen matt Schwarz, Zement, Talco oder in den glänzenden Farben der Acque di Cielo erhältlich, für unendliche Farbspiele mit dem Keramikwaschbecken und dem Möbel.

### ОТДЕЛКИ

Для коллекции Theo мы выбрали гамму цветов FENIX, которые идеально сочетаются с отделками нашей керамики, создавая множество возможностей для индивидуальных проектов. Металлические элементы (ножки и полотенцедержатели) могут быть выполнены в отделках Nero Matt, Cemento, Talco или в глянцевых цветах палитры Acque di Cielo, тем самым создавая неограниченные хроматические комбинации керамических раковин и мебели.

## NOTE

The furniture is suitable for both floor and hanging installation. Mandatory composition: basin+ furniture + towel rail. Legs are for floor furniture only. / El mueble está diseñado para instalación tanto a suelo como suspendido. Composición obligatoria: lavabo + mueble + toallero. Las patas son solo para la versión de mueble a suelo / On peut installer le meuble au sol ou suspendu. La composition vasque + meuble + porte-serviettes est obligatoire. Les pieds sont uniquement pour la version au sol / Das Möbel ist in Standversion erhältlich und auch für Wandmontage geeignet. Das Möbel besteht obligatorisch aus: Becken + Möbel + Handtuchhalter. Die Beine sind nur für die Standversion vorgesehen / Мебель возможна в двух версиях: напольная и подвесная. Обязательный комплект: раковина + тумба + полотенцесушитель. Ножки только для напольной версии.

# Theo Mini

modelli disponibili / available models

## THEO collection

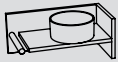

Theo Mini

55,5 x 31 x 24 h



finiture / finishes

### LAVABO IN CERAMICA / CERAMIC WASHBASIN

#### Le Terre di Cielo



#### Le Acque di Cielo



### MOBILE IN FENIX / FENIX CABINET

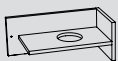

THMF55

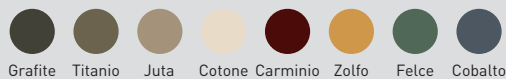

### PORTASCIUGAMANI IN METALLO / TOWEL RAIL



THPL55

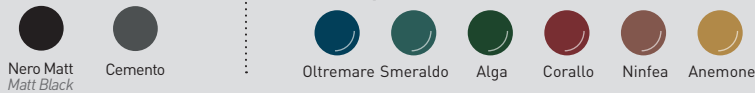

lavabi installabili / washbasins

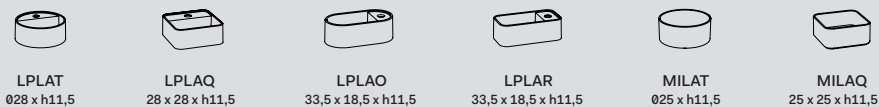

LPLAT  
028 x h11,5

LPLAQ  
28 x 28 x h11,5

LPLAO  
33,5 x 18,5 x h11,5

LPLAR  
33,5 x 18,5 x h11,5

MILAT  
025 x h11,5

MILAQ  
25 x 25 x h11,5

note tecniche lavabo / washbasin technical notes

monoforo  
one tap hole

senza foro su richiesta  
no tap hole on request

senza foro  
without hole  
(art. MILAT, MILAQ)

senza troppopieno  
without overflow

installazione da piano  
on top installation

con tutti i lati smaltati  
all enamelled sides

composizione obbligatoria: mobile + portasciugamani  
mandatory composition: cabinet + towel rail

CLIENTE/client:  ORD. REF.:

QUANTITÀ /quantity:  EMAIL:

**INDICARE CON UN SEGNO LE FINITURE SCELTE PER I DIVERSI COMPONENTI**

*INDICATE WITH A TICK, THE CHOOSEN FINISHES FOR ALL THE COMPONENTS*

**FINITURE LAVABO**  
*WASHBASIN FINISHES*

Bianco/white - glossy

Le Terre di Cielo

<input type="radio"/> TL - Talco	<input type="radio"/> AN - Arenaria
<input type="radio"/> PM - Pomice	<input type="radio"/> AV - Avena
<input type="radio"/> BR - Brina	<input type="radio"/> LN - Lino
<input type="radio"/> BA - Basalto	<input type="radio"/> AG - Agave
<input type="radio"/> LV - Lavagna	<input type="radio"/> MU - Muschio
<input type="radio"/> CM - Cemento	<input type="radio"/> PL - Polvere
<input type="radio"/> FN - Fango	<input type="radio"/> CP - Cipria
<input type="radio"/> CA - Cacao	<input type="radio"/> CN - Canapa

Le Acque di Cielo

<input type="radio"/> OL - Oltremare	<input type="radio"/> CO - Corallo
<input type="radio"/> SM - Smeraldo	<input type="radio"/> NI - Ninfea
<input type="radio"/> AL - Alga	<input type="radio"/> AM - Anemone

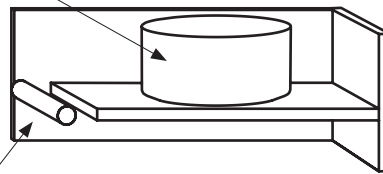

art. **THMF55**

**FINITURE MOBILE IN FENIX**  
*FENIX CABINET FINISHES*

- FGR - Grafite
- FTI - Titanio
- FJU - Juta
- FCO - Cotone
- FZO - Zolfo
- FFE - Felce
- FCB - Cobalto
- FCA - Carminio

art. **THPL55**

**FINITURE PORTASCIUGAMANI**  
*TOWEL RAIL FINISHES*

verniciature\_coatings

- NM - Nero Matt
- CM - Cemento

Le Acque di Cielo

<input type="radio"/> OL - Oltremare	<input type="radio"/> CO - Corallo
<input type="radio"/> SM - Smeraldo	<input type="radio"/> NI - Ninfea
<input type="radio"/> AL - Alga	<input type="radio"/> AM - Anemone

**LAVABI ABBINABILI**  
*MATCHING WASHBASINS*



art. **LPLAT/LPLATSF**



art. **LPLAR/LPLARSF**



art. **LPLAQ/LPLAQSF**

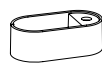

art. **LPLAO/LPLAOSF**



art. **MILAT**



art. **MILAQ**

**DATA**  
DATE

**FIRMA DEL CLIENTE**  
SIGNATURE

ATTENZIONE:  
La rappresentazione delle finiture è puramente indicativa. Verificare le finiture con le relative cartelle.

Ogni oggetto possiede la peculiarità di essere elaborato secondo principi puramente tradizionali, in modo da garantirne l'assoluta originalità ed unicità. Le eventuali piccole variazioni di colore, tono o venature fra gli articoli sono da considerarsi pregi e non difetti, in quanto garanzia della fattura manuale del prodotto, che fa di ogni oggetto Cielo un pezzo unico ed esclusivo, lontano dall'omologazione industriale. In fase d'ordine si intendono, pertanto, accettate tali tolleranze che non possono dare adito a contestazioni di alcun genere.

Verificare sempre le disponibilità e i tempi di consegna con il commerciale.

ATTENTION:  
The representation of the finishes is merely indicative. Please choose the finishes using the folders.

Every item possesses that particular feature of being processed according to purely traditional principles that guarantee its absolute originality and uniqueness. The small variations in colour, hues or streaks on the items are to be considered as qualities and not defects, since they warranty the handcrafted processing which makes each Cielo item a unique and exclusive piece that cannot be compared to industrial standardization. When making the order, the client implicitly accepts those various features that may give rise to claims of any sort.

Always check the availability and delivery time with the commercial department.

# Theo 70



modelli disponibili / available models

**THEO**  
collection

Theo 70

72,5 x 38 x 29 h



finiture / finishes

LAVABO IN CERAMICA / CERAMIC WASHBASIN

Le Terre di Cielo

Bianco Lucido  
Glass White

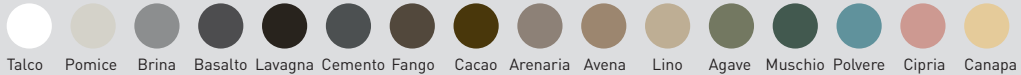

Le Acque di Cielo



THLAT

MOBILE IN FENIX / FENIX CABINET

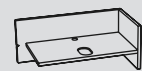
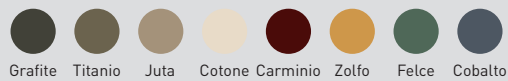

THMF70



THMF70SF

PORTASCIUGAMANI IN METALLO / TOWEL RAIL

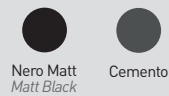

Nero Matt  
Matt Black

Cemento

Le Acque di Cielo

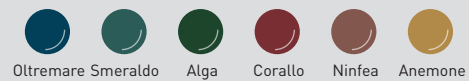

THPL70

note tecniche lavabo / washbasin technical notes

 senza troppopieno  
without overflow

 installazione da piano  
on top installation

 senza foro  
without hole

 con tutti i lati smaltati  
all enamelled sides

 composizione obbligatoria:  
mobile + portasciugamani + art. THKIT  
mandatory composition:  
cabinet + towel rail + art. THKIT

CLIENTE/client:  ORD. REF.:

QUANTITÀ/quantity:  EMAIL:

**INDICARE CON UN SEGNO LE FINITURE SCELTE PER I DIVERSI COMPONENTI**

*INDICATE WITH A TICK, THE CHOOSEN FINISHES FOR ALL THE COMPONENTS*

art. **THLAT**

**FINITURE LAVABO**  
WASHBASIN FINISHES

Bianco/white - glossy

Le Terre di Cielo

<input type="checkbox"/> TL - Talco	<input type="checkbox"/> AN - Arenaria
<input type="checkbox"/> PM - Pomice	<input type="checkbox"/> AV - Avena
<input type="checkbox"/> BR - Brina	<input type="checkbox"/> LN - Lino
<input type="checkbox"/> BA - Basalto	<input type="checkbox"/> AG - Agave
<input type="checkbox"/> LV - Lavagna	<input type="checkbox"/> MU - Muschio
<input type="checkbox"/> CM - Cemento	<input type="checkbox"/> PL - Polvere
<input type="checkbox"/> FN - Fango	<input type="checkbox"/> CP - Cipria
<input type="checkbox"/> CA - Cacao	<input type="checkbox"/> CN - Canapa

Le Acque di Cielo

<input type="checkbox"/> OL - Oltremare	<input type="checkbox"/> CO - Corallo
<input type="checkbox"/> SM - Smeraldo	<input type="checkbox"/> NI - Ninfea
<input type="checkbox"/> AL - Alga	<input type="checkbox"/> AM - Anemone

art. **THMF70/THMF70SF**

**FINITURE MOBILE IN FENIX**  
FENIX CABINET FINISHES

<input type="checkbox"/> FGR - Grafite
<input type="checkbox"/> FTI - Titanio
<input type="checkbox"/> FJU - Juta
<input type="checkbox"/> FCO - Cotone
<input type="checkbox"/> FZO - Zolfo
<input type="checkbox"/> FFE - Felce
<input type="checkbox"/> FCB - Cobalto
<input type="checkbox"/> FCA - Carminio

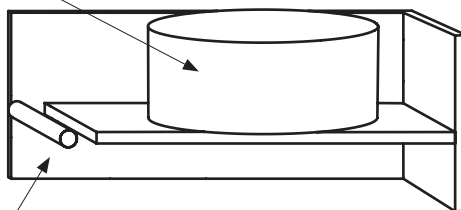

art. **THPL70**

**FINITURE PORTASCIUGAMANI**  
TOWEL RAIL FINISHES

verniciature\_coatings

<input type="checkbox"/> NM - Nero Matt
<input type="checkbox"/> CM - Cemento

Le Acque di Cielo

<input type="checkbox"/> OL - Oltremare	<input type="checkbox"/> CO - Corallo
<input type="checkbox"/> SM - Smeraldo	<input type="checkbox"/> NI - Ninfea
<input type="checkbox"/> AL - Alga	<input type="checkbox"/> AM - Anemone

**DATA**  
DATE

**FIRMA DEL CLIENTE**  
SIGNATURE

ATTENZIONE:  
La rappresentazione delle finiture è puramente indicativa. Verificare le finiture con le relative cartelle.

ATTENTION:  
The representation of the finishes is merely indicative. Please choose the finishes using the folders.

Ogni oggetto possiede la peculiarità di essere elaborato secondo principi puramente tradizionali, in modo da garantirne l'assoluta originalità ed unicità. Le eventuali piccole variazioni di colore, tono o venature fra gli articoli sono da considerarsi pregi e non difetti, in quanto garanzia della fattura manuale del prodotto, che fa di ogni oggetto Cielo un pezzo unico ed esclusivo, lontano dall'omologazione industriale. In fase d'ordine si intendono, pertanto, accettate tali tolleranze che non possono dare adito a contestazioni di alcun genere.

Every item possesses that particular feature of being processed according to purely traditional principles that guarantee its absolute originality and uniqueness. The small variations in colour, hues or streaks on the items are to be considered as qualities and not defects, since they warranty the handcrafted processing which makes each Cielo item a unique and exclusive piece that cannot be compared to industrial standardization. When making the order, the client implicitly accepts those various features that may give rise to claims of any sort.

Verificare sempre le disponibilità e i tempi di consegna con il commerciale.

Always check the availability and delivery time with the commercial department.

# Theo 78

modelli disponibili / available models

## THEO collection



Theo 78  
78 x 38 x 87 h



### finiture / finishes

#### LAVABO IN CERAMICA / CERAMIC WASHBASIN

##### Le Terre di Cielo



THLAT



##### Le Acque di Cielo

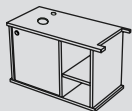
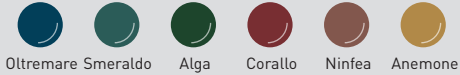

THMF78

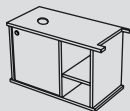

THMF78SF

#### MOBILE IN FENIX / FENIX CABINET

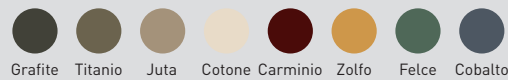

#### PORTASCIUGAMANI IN METALLO / TOWEL RAIL



THPL

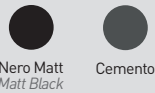

##### Le Acque di Cielo

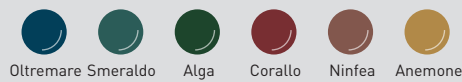

#### GAMBA IN METALLO / METAL LEG



THGA

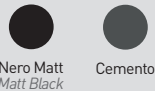

##### Le Acque di Cielo



### note tecniche lavabo / washbasin technical notes



senza foro  
without hole



senza troppopieno  
without overflow



installazione da piano  
on top installation



con tutti i lati smaltati  
all enamelled sides



Il mobile è predisposto per installazione sia a terra che sospesa.  
Composizione obbligatoria: lavabo + mobile + portasciugamani. Le  
gambe sono solo per la versione del mobile a terra.  
The furniture is suitable for both floor and hanging installation.  
Mandatory composition: basin+ furniture + towel rail. Legs are for floor  
furniture only.



CLIENTE/client:  ORD. REF.:

QUANTITÀ/quantity:  EMAIL:

**INDICARE CON UN SEGNO LE FINITURE SCELTE PER I DIVERSI COMPONENTI**

**INDICATE WITH A TICK, THE CHOSEN FINISHES FOR ALL THE COMPONENTS**

art. **THLAT**

**FINITURE LAVABO**

WASHBASIN FINISHES

Bianco/white - glossy

Le Terre di Cielo

- |                                    |                                     |
|------------------------------------|-------------------------------------|
| <input type="radio"/> TL - Talco   | <input type="radio"/> AN - Arenaria |
| <input type="radio"/> PM - Pomice  | <input type="radio"/> AV - Avena    |
| <input type="radio"/> BR - Brina   | <input type="radio"/> LN - Lino     |
| <input type="radio"/> BA - Basalto | <input type="radio"/> AG - Agave    |
| <input type="radio"/> LV - Lavagna | <input type="radio"/> MU - Muschio  |
| <input type="radio"/> CM - Cemento | <input type="radio"/> PL - Polvere  |
| <input type="radio"/> FN - Fango   | <input type="radio"/> CP - Cipria   |
| <input type="radio"/> CA - Cacao   | <input type="radio"/> CN - Canapa   |

Le Acque di Cielo

- |                                      |                                    |
|--------------------------------------|------------------------------------|
| <input type="radio"/> OL - Oltremare | <input type="radio"/> CO - Corallo |
| <input type="radio"/> SM - Smeraldo  | <input type="radio"/> NI - Ninfea  |
| <input type="radio"/> AL - Alga      | <input type="radio"/> AM - Anemone |

art. **THMF78/THMF78SF**

**FINITURE MOBILE IN FENIX**

FENIX CABINET FINISHES

- |                                      |
|--------------------------------------|
| <input type="radio"/> FGR - Grafite  |
| <input type="radio"/> FTI - Titanio  |
| <input type="radio"/> FJU - Juta     |
| <input type="radio"/> FCO - Cotone   |
| <input type="radio"/> FZO - Zolfo    |
| <input type="radio"/> FFE - Felce    |
| <input type="radio"/> FCB - Cobalto  |
| <input type="radio"/> FCA - Carminio |

art. **THPL**

**FINITURE PORTASCIUGAMANI**

TOWEL RAIL FINISHES

verniciature\_coatings

- |                                      |
|--------------------------------------|
| <input type="radio"/> NM - Nero Matt |
| <input type="radio"/> CM - Cemento   |

Le Acque di Cielo

- |                                      |                                    |
|--------------------------------------|------------------------------------|
| <input type="radio"/> OL - Oltremare | <input type="radio"/> CO - Corallo |
| <input type="radio"/> SM - Smeraldo  | <input type="radio"/> NI - Ninfea  |
| <input type="radio"/> AL - Alga      | <input type="radio"/> AM - Anemone |

art. **THGA**

**FINITURE GAMBA METALLICA**

METAL LEG FINISHES

verniciature\_coatings

- |                                      |
|--------------------------------------|
| <input type="radio"/> NM - Nero Matt |
| <input type="radio"/> CM - Cemento   |

Le Acque di Cielo

- |                                      |                                    |
|--------------------------------------|------------------------------------|
| <input type="radio"/> OL - Oltremare | <input type="radio"/> CO - Corallo |
| <input type="radio"/> SM - Smeraldo  | <input type="radio"/> NI - Ninfea  |
| <input type="radio"/> AL - Alga      | <input type="radio"/> AM - Anemone |

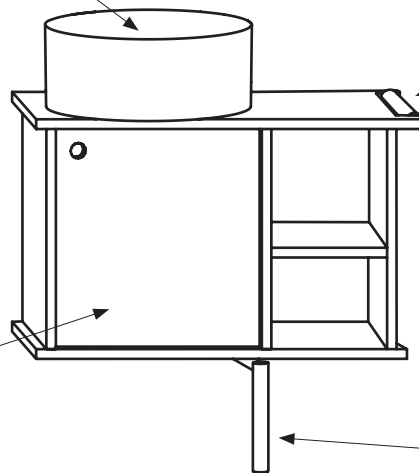

**DATA**  
DATE

ATTENZIONE:  
La rappresentazione delle finiture è puramente indicativa. Verificare le finiture con le relative cartelle.

Ogni oggetto possiede la peculiarità di essere elaborato secondo principi puramente tradizionali, in modo da garantire l'assoluta originalità ed unicità. Le eventuali piccole variazioni di colore, tono o venature fra gli articoli sono da considerarsi pregi e non difetti, in quanto garanzia della fattura manuale del prodotto, che fa di ogni oggetto Cielo un pezzo unico ed esclusivo, lontano dall'omologazione industriale. In fase d'ordine si intendono, pertanto, accettate tali tolleranze che non possono dare adito a contestazioni di alcun genere.

Verificare sempre le disponibilità e i tempi di consegna con il commerciale.

**FIRMA DEL CLIENTE**  
SIGNATURE

ATTENTION:  
The representation of the finishes is merely indicative. Please choose the finishes using the folders.

Every item possesses that particular feature of being processed according to purely traditional principles that guarantee its absolute originality and uniqueness. The small variations in colour, hues or streaks on the items are to be considered as qualities and not defects, since they warranty the handcrafted processing which makes each Cielo item a unique and exclusive piece that cannot be compared to industrial standardization. When making the order, the client implicitly accepts those various features that may give rise to claims of any sort.

Always check the availability and delivery time with the commercial department.

# Theo 103



modelli disponibili / available models

**THEO**  
collection

Theo 103  
103 x 38 x 29 h

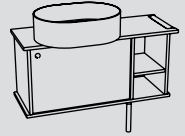

finiture / finishes

## LAVABO IN CERAMICA / CERAMIC WASHBASIN

Bianco Lucido  
Gloss White

Talco Pomice Brina Basalto Lavagna Cemento Fango Cacao Arenaria Avena Lino Agave Muschio Polvere Cipria Canapa

Le Terre di Cielo



THLAT

Le Acque di Cielo

Oltremare Smeraldo Alga Corallo Ninfea Anemone



THLAA

## MOBILE IN FENIX / FENIX CABINET

Grafite Titanio Juta Cotone Carminio Zolfo Felce Cobalto

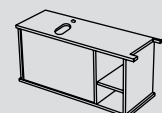

THMF103

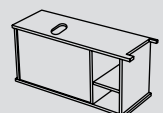

THMF103SF

## PORTASCIUGAMANI IN METALLO / TOWEL RAIL

Nero Matt  
Matt Black

Cemento

Le Acque di Cielo

Oltremare Smeraldo Alga Corallo Ninfea Anemone



THPL

## GAMBA IN METALLO / METAL LEG

Nero Matt  
Matt Black

Cemento

Le Acque di Cielo

Oltremare Smeraldo Alga Corallo Ninfea Anemone



THGA

## note tecniche lavabo / washbasin technical notes



senza foro  
without hole



senza troppopieno  
without overflow



installazione da piano  
on top installation



con tutti i lati smaltati  
all enamelled sides



Il mobile è predisposto per installazione sia a terra che sospesa.  
Composizione obbligatoria: lavabo + mobile + portasciugamani.  
Le gambe sono solo per la versione del mobile a terra.  
The furniture is suitable for both floor and hanging installation.  
Mandatory composition: basin+ furniture + towel rail. Legs are for floor furniture only.

CLIENTE/client:  ORD. REF.:

QUANTITÀ/quantity:  EMAIL:

**INDICARE CON UN SEGNO LE FINITURE SCELTE PER I DIVERSI COMPONENTI**

*INDICATE WITH A TICK, THE CHOOSEN FINISHES FOR ALL THE COMPONENTS*

**FINITURE LAVABO**  
WASHBASIN FINISHES

Bianco/white - glossy

Le Terre di Cielo

<input type="radio"/> TL - Talco	<input type="radio"/> AN - Arenaria
<input type="radio"/> PM - Pomice	<input type="radio"/> AV - Avena
<input type="radio"/> BR - Brina	<input type="radio"/> LN - Lino
<input type="radio"/> BA - Basalto	<input type="radio"/> AG - Agave
<input type="radio"/> LV - Lavagna	<input type="radio"/> MU - Muschio
<input type="radio"/> CM - Cemento	<input type="radio"/> PL - Polvere
<input type="radio"/> FN - Fango	<input type="radio"/> CP - Cipria
<input type="radio"/> CA - Cacao	<input type="radio"/> CN - Canapa

Le Acque di Cielo

<input type="radio"/> OL - Oltremare	<input type="radio"/> CO - Corallo
<input type="radio"/> SM - Smeraldo	<input type="radio"/> NI - Ninfea
<input type="radio"/> AL - Alga	<input type="radio"/> AM - Anemone

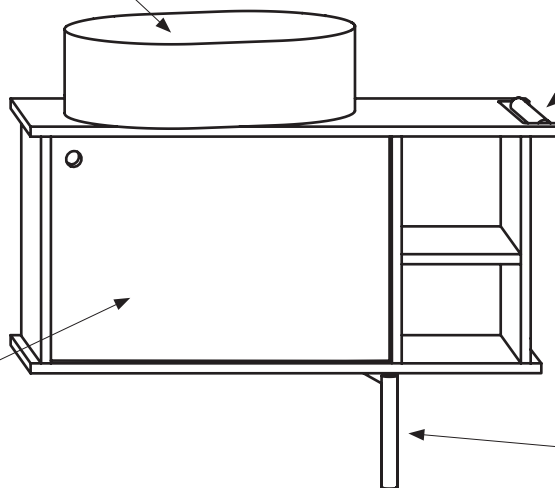

art. **THMF103/THMF103SF**

**FINITURE MOBILE IN FENIX**  
FENIX CABINET FINISHES

<input type="radio"/> FGR - Grafite
<input type="radio"/> FTI - Titanio
<input type="radio"/> FJU - Juta
<input type="radio"/> FCO - Cotone
<input type="radio"/> FZO - Zolfo
<input type="radio"/> FFE - Felce
<input type="radio"/> FCB - Cobalto
<input type="radio"/> FCA - Carminio

art. **THPL**

**FINITURE PORTASCIUGAMANI**  
TOWEL RAIL FINISHES

verniciature\_coatings

<input type="radio"/> NM - Nero Matt
<input type="radio"/> CM - Cemento

Le Acque di Cielo

<input type="radio"/> OL - Oltremare	<input type="radio"/> CO - Corallo
<input type="radio"/> SM - Smeraldo	<input type="radio"/> NI - Ninfea
<input type="radio"/> AL - Alga	<input type="radio"/> AM - Anemone

art. **THGA**

**FINITURE GAMBA METALLICA**  
METAL LEG FINISHES

verniciature\_coatings

<input type="radio"/> NM - Nero Matt
<input type="radio"/> CM - Cemento

Le Acque di Cielo

<input type="radio"/> OL - Oltremare	<input type="radio"/> CO - Corallo
<input type="radio"/> SM - Smeraldo	<input type="radio"/> NI - Ninfea
<input type="radio"/> AL - Alga	<input type="radio"/> AM - Anemone

**LAVABI ABBINABILI**  
MATCHING WASHBASINS



art. **THLAT**



art. **THLAO**

**DATA**  
DATE

**FIRMA DEL CLIENTE**  
SIGNATURE

ATTENZIONE:  
La rappresentazione delle finiture è puramente indicativa. Verificare le finiture con le relative cartelle.

ATTENTION:  
The representation of the finishes is merely indicative. Please choose the finishes using the folders.

Ogni oggetto possiede la peculiarità di essere elaborato secondo principi puramente tradizionali, in modo da garantirne l'assoluta originalità ed unicità. Le eventuali piccole variazioni di colore, tono o venature fra gli articoli sono da considerarsi pregi e non difetti, in quanto garanzia della fattura manuale del prodotto, che fa di ogni oggetto Cielo un pezzo unico ed esclusivo, lontano dall'omologazione industriale. In fase d'ordine si intendono, pertanto, accettate tali tolleranze che non possono dare adito a contestazioni di alcun genere.

Every item possesses that particular feature of being processed according to purely traditional principles that guarantee its absolute originality and uniqueness. The small variations in colour, hues or streaks on the items are to be considered as qualities and not defects, since they warranty the handcrafted processing which makes each Cielo item a unique and exclusive piece that cannot be compared to industrial standardization. When making the order, the client implicitly accepts those various features that may give rise to claims of any sort.

Verificare sempre le disponibilità e i tempi di consegna con il commerciale.

Always check the availability and delivery time with the commercial department.

# Theo 175

modelli disponibili / available models

## THEO collection

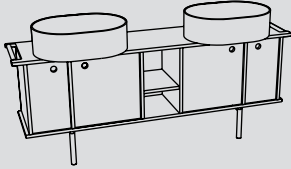

**Theo 175 con 4 ante e un vano giorno in Fenix**  
Theo 175 cabinet with 4 doors and an open compartment

175 x 38 x 87 h



finiture / finishes

### LAVABO IN CERAMICA / CERAMIC WASHBASIN



THLAT

#### Le Terre di Cielo



Bianco Lucido  
Glass White



THLAO

#### Le Acque di Cielo



### MOBILE IN FENIX / FENIX CABINET

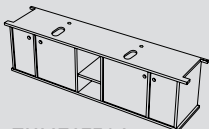

THMF175A4

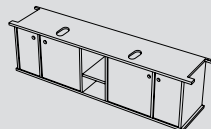

THMF175A4SF

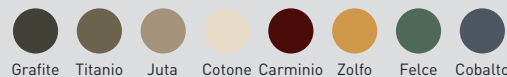

### PORTASCIUGAMANI IN METALLO / TOWEL RAIL



THPL

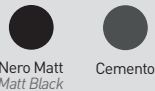

Nero Matt  
Matt Black

Cemento

#### Le Acque di Cielo



Oltremare

Smeraldo

Alga

Corallo

Ninfea

Anemone

### GAMBA IN METALLO / METAL LEG



THGA

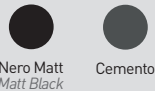

Nero Matt  
Matt Black

Cemento

#### Le Acque di Cielo



Oltremare

Smeraldo

Alga

Corallo

Ninfea

Anemone

note tecniche lavabo / washbasin technical notes



senza foro  
without hole



senza troppopieno  
without overflow



installazione da piano  
on top installation



con tutti i lati smaltati  
all enamelled sides



Il mobile è predisposto per installazione sia a terra che sospesa.  
Composizione obbligatoria: lavabo + mobile + portasciugamani. Le  
gambe sono solo per la versione del mobile a terra.

The furniture is suitable for both floor and hanging installation.  
Mandatory composition: basin+ furniture + towel rail. Legs are for  
floor furniture only.

# Modulo Ordine Theo 175 con 4 ante e un vano giorno

Theo 175 with 4 doors and a day compartment Order Form

CLIENTE/client:  ORD. REF.:

QUANTITÀ/quantity:  EMAIL:

INDICARE CON UN SEGNO LE FINITURE SCELTE PER I DIVERSI COMPONENTI

INDICATE WITH A TICK, THE CHOSEN FINISHES FOR ALL THE COMPONENTS

**FINITURE LAVABO**  
WASHBASIN FINISHES

Bianco/white - glossy

Le Terre di Cielo

<input type="radio"/> TL - Talco	<input type="radio"/> AN - Arenaria
<input type="radio"/> PM - Pomice	<input type="radio"/> AV - Avena
<input type="radio"/> BR - Brina	<input type="radio"/> LN - Lino
<input type="radio"/> BA - Basalto	<input type="radio"/> AG - Agave
<input type="radio"/> LV - Lavagna	<input type="radio"/> MU - Muschio
<input type="radio"/> CM - Cemento	<input type="radio"/> PL - Polvere
<input type="radio"/> FN - Fango	<input type="radio"/> CP - Cipria
<input type="radio"/> CA - Cacao	<input type="radio"/> CN - Canapa

Le Acque di Cielo

<input type="radio"/> OL - Oltremare	<input type="radio"/> CO - Corallo
<input type="radio"/> SM - Smeraldo	<input type="radio"/> NI - Ninfea
<input type="radio"/> AL - Alga	<input type="radio"/> AM - Anemone

art. **THMF175A4/THMF175A4SF**

**FINITURE MOBILE IN FENIX**  
FENIX CABINET FINISHES

<input type="radio"/> FGR - Grafite
<input type="radio"/> FTI - Titanio
<input type="radio"/> FJU - Juta
<input type="radio"/> FCO - Cotone
<input type="radio"/> FZO - Zolfo
<input type="radio"/> FFE - Felce
<input type="radio"/> FCB - Cobalto
<input type="radio"/> FCA - Carminio

**LAVABI ABBINABILI**  
MATCHING WASHBASINS



art. **THLAT**



art. **THLAO**

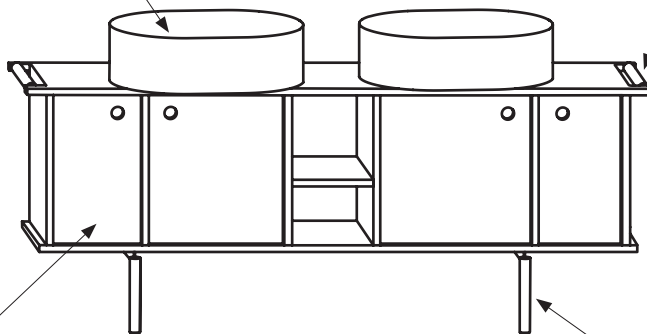

art. **THPL**

**FINITURE PORTASCIUGAMANI**  
TOWEL RAIL FINISHES

verniciature\_coatings

<input type="radio"/> NM - Nero Matt
<input type="radio"/> CM - Cemento

Le Acque di Cielo

<input type="radio"/> OL - Oltremare	<input type="radio"/> CO - Corallo
<input type="radio"/> SM - Smeraldo	<input type="radio"/> NI - Ninfea
<input type="radio"/> AL - Alga	<input type="radio"/> AM - Anemone

art. **THGA**

**FINITURE GAMBA METALLICA**  
METAL LEG FINISHES

verniciature\_coatings

<input type="radio"/> NM - Nero Matt
<input type="radio"/> CM - Cemento

Le Acque di Cielo

<input type="radio"/> OL - Oltremare	<input type="radio"/> CO - Corallo
<input type="radio"/> SM - Smeraldo	<input type="radio"/> NI - Ninfea
<input type="radio"/> AL - Alga	<input type="radio"/> AM - Anemone

**DATA**  
DATE

**FIRMA DEL CLIENTE**  
SIGNATURE

ATTENZIONE: La rappresentazione delle finiture è puramente indicativa. Verificare le finiture con le relative cartelle.

ATTENTION: The representation of the finishes is merely indicative. Please choose the finishes using the folders.

Ogni oggetto possiede la peculiarità di essere elaborato secondo principi puramente tradizionali, in modo da garantirne l'assoluta originalità ed unicità. Le eventuali piccole variazioni di colore, tono o venature fra gli articoli sono da considerarsi pregi e non difetti, in quanto garanzia della fattura manuale del prodotto, che fa di ogni oggetto Cielo un pezzo unico ed esclusivo, lontano dall'omologazione industriale. In fase d'ordine si intendono, pertanto, accettate tali tolleranze che non possono dare adito a contestazioni di alcun genere.

Every item possesses that particular feature of being processed according to purely traditional principles that guarantee its absolute originality and uniqueness. The small variations in colour, hues or streaks on the items are to be considered as qualities and not defects, since they warranty the handcrafted processing which makes each Cielo item a unique and exclusive piece that cannot be compared to industrial standardization. When making the order, the client implicitly accepts those various features that may give rise to claims of any sort.

Verificare sempre le disponibilità e i tempi di consegna con il commerciale.

Always check the availability and delivery time with the commercial department.

# Theo 175



modelli disponibili / available models

## THEO collection

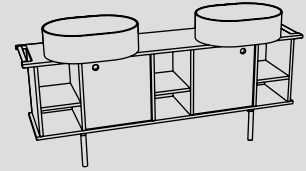

**Theo 175 con 2 ante  
e 3 vani giorno in Fenix**  
Theo 175 cabinet with  
2 doors and 3 open  
compartments

175 x 38 x 87 h

finiture / finishes

### LAVABO IN CERAMICA / CERAMIC WASHBASIN

**Le Terre di Cielo**

Bianco Lucido  
Gloss White

Talco Pomice Brina Basalto Lavagna Cemento Fango Cacao Arenaria Avena Lino Agave Muschio Polvere Cipria Canapa

**Le Acque di Cielo**

Oltremare Smeraldo Alga Corallo Ninfea Anemone

THLAT

THLAO

### MOBILE IN FENIX / FENIX CABINET

Grafite Titanio Juta Cotone Carminio Zolfo Felce Cobalto

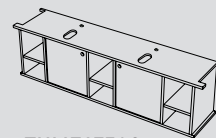

THMF175A2

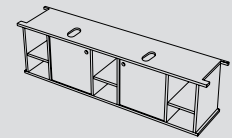

THMF175A2SF

### PORTASCIUGAMANI IN METALLO / TOWEL RAIL

**Le Acque di Cielo**

Nero Matt  
Matt Black

Cemento

Oltremare Smeraldo Alga Corallo Ninfea Anemone

THPL

### GAMBA IN METALLO / METAL LEG

**Le Acque di Cielo**

THGA

### note tecniche lavabo / washbasin technical notes

senza foro  
without hole

senza troppopieno  
without overflow

installazione da piano  
on top installation

con tutti i lati smaltati  
all enamelled sides

Il mobile è predisposto per installazione sia a terra che sospesa.  
Composizione obbligatoria: lavabo + mobile + portasciugamani. Le  
gambe sono solo per la versione del mobile a terra.  
The furniture is suitable for both floor and hanging installation.  
Mandatory composition: basin+ furniture + towel rail. Legs are for  
floor furniture only.

# Modulo Ordine Theo 175 con 2 ante e 3 vani giorno

## Theo 175 with 2 doors and 3 day compartments Order Form

# cielo

CLIENTE/client:  ORD. REF.:

QUANTITÀ/quantity:  EMAIL:

INDICARE CON UN SEGNO LE FINITURE SCELTE PER I DIVERSI COMPONENTI

INDICATE WITH A TICK, THE CHOSEN FINISHES FOR ALL THE COMPONENTS

**FINITURE LAVABO**  
WASHBASIN FINISHES

Bianco/white - glossy

Le Terre di Cielo

<input type="radio"/> TL - Talco	<input type="radio"/> AN - Arenaria
<input type="radio"/> PM - Pomice	<input type="radio"/> AV - Avena
<input type="radio"/> BR - Brina	<input type="radio"/> LN - Lino
<input type="radio"/> BA - Basalto	<input type="radio"/> AG - Agave
<input type="radio"/> LV - Lavagna	<input type="radio"/> MU - Muschio
<input type="radio"/> CM - Cemento	<input type="radio"/> PL - Polvere
<input type="radio"/> FN - Fango	<input type="radio"/> CP - Cipria
<input type="radio"/> CA - Cacao	<input type="radio"/> CN - Canapa

Le Acque di Cielo

<input type="radio"/> OL - Oltremare	<input type="radio"/> CO - Corallo
<input type="radio"/> SM - Smeraldo	<input type="radio"/> NI - Ninfea
<input type="radio"/> AL - Alga	<input type="radio"/> AM - Anemone

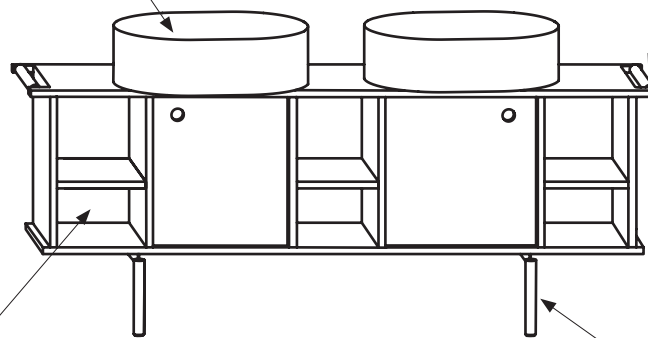

art. **THPL**

**FINITURE PORTASCIUGAMANI**  
TOWEL RAIL FINISHES

verniciature\_coatings

<input type="radio"/> NM - Nero Matt	<input type="radio"/> CM - Cemento
--------------------------------------	------------------------------------

Le Acque di Cielo

<input type="radio"/> OL - Oltremare	<input type="radio"/> CO - Corallo
<input type="radio"/> SM - Smeraldo	<input type="radio"/> NI - Ninfea
<input type="radio"/> AL - Alga	<input type="radio"/> AM - Anemone

art. **THMF175A2/THMF175A2SF**

**FINITURE MOBILE IN FENIX**  
FENIX CABINET FINISHES

<input type="radio"/> FGR - Grafite
<input type="radio"/> FTI - Titanio
<input type="radio"/> FJU - Juta
<input type="radio"/> FCO - Cotone
<input type="radio"/> FZO - Zolfo
<input type="radio"/> FFE - Felce
<input type="radio"/> FCB - Cobalto
<input type="radio"/> FCA - Carminio

art. **THGA**

**FINITURE GAMBA METALLICA**  
METAL LEG FINISHES

verniciature\_coatings

<input type="radio"/> NM - Nero Matt	<input type="radio"/> CM - Cemento
--------------------------------------	------------------------------------

Le Acque di Cielo

<input type="radio"/> OL - Oltremare	<input type="radio"/> CO - Corallo
<input type="radio"/> SM - Smeraldo	<input type="radio"/> NI - Ninfea
<input type="radio"/> AL - Alga	<input type="radio"/> AM - Anemone

**LAVABI ABBINABILI**  
MATCHING WASHBASINS



art. **THLAT**



art. **THLAO**

**DATA**  
DATE

**FIRMA DEL CLIENTE**  
SIGNATURE

ATTENZIONE: La rappresentazione delle finiture è puramente indicativa. Verificare le finiture con le relative cartelle.

ATTENTION: The representation of the finishes is merely indicative. Please choose the finishes using the folders.

Ogni oggetto possiede la peculiarità di essere elaborato secondo principi puramente tradizionali, in modo da garantirne l'assoluta originalità ed unicità. Le eventuali piccole variazioni di colore, tono o venature fra gli articoli sono da considerarsi pregi e non difetti, in quanto garanzia della fattura manuale del prodotto, che fa di ogni oggetto Cielo un pezzo unico ed esclusivo, lontano dall'omologazione industriale. In fase d'ordine si intendono, pertanto, accettate tali tolleranze che non possono dare adito a contestazioni di alcun genere.

Every item possesses that particular feature of being processed according to purely traditional principles that guarantee its absolute originality and uniqueness. The small variations in colour, hues or streaks on the items are to be considered as qualities and not defects, since they warranty the handcrafted processing which makes each Cielo item a unique and exclusive piece that cannot be compared to industrial standardization. When making the order, the client implicitly accepts those various features that may give rise to claims of any sort.

Verificare sempre le disponibilità e i tempi di consegna con il commerciale.

Always check the availability and delivery time with the commercial department.



# Theo 175

modelli disponibili / available models

## THEO collection

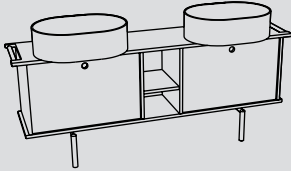

**Theo 175 con 2 cassettoni e un vano giorno in Fenix**  
Theo 175 cabinet with 2 doors and an open compartment

175 x 38 x 87 h



finiture / finishes

### LAVABO IN CERAMICA / CERAMIC WASHBASIN



THLAT

#### Le Terre di Cielo



Bianco Lucido  
Glass White



THLAO

#### Le Acque di Cielo



### MOBILE IN FENIX / FENIX CABINET

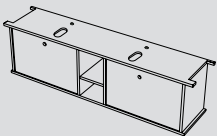

THMF175C2

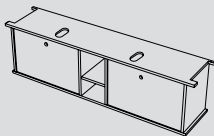

THMF175C2SF

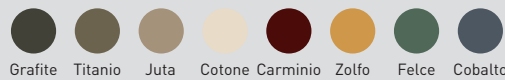

### PORTASCIUGAMANI IN METALLO / TOWEL RAIL



THPL

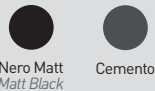

Nero Matt  
Matt Black

Cemento

#### Le Acque di Cielo



Oltremare

Smeraldo

Alga

Corallo

Ninfea

Anemone

### GAMBA IN METALLO / METAL LEG



THGA

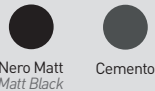

Nero Matt  
Matt Black

Cemento

#### Le Acque di Cielo



Oltremare

Smeraldo

Alga

Corallo

Ninfea

Anemone

note tecniche lavabo / washbasin technical notes



senza foro  
without hole



senza troppopieno  
without overflow



installazione da piano  
on top installation



con tutti i lati smaltati  
all enamelled sides



Il mobile è predisposto per installazione sia a terra che sospesa.  
Composizione obbligatoria: lavabo + mobile + portasciugamani.  
Le gambe sono solo per la versione del mobile a terra.  
The furniture is suitable for both floor and hanging installation.  
Mandatory composition: basin+ furniture + towel rail. Legs are for floor furniture only.

# Modulo Ordine Theo 175 con 2 cassettoni e un vano giorno

## Theo 175 with 2 drawers and a day compartment Order Form

# cielo

CLIENTE/client:  ORD. REF.:

QUANTITÀ/quantity:  EMAIL:

**INDICARE CON UN SEGNO LE FINITURE SCELTE PER I DIVERSI COMPONENTI**

*INDICATE WITH A TICK, THE CHOSEN FINISHES FOR ALL THE COMPONENTS*

**FINITURE LAVABO**  
WASHBASIN FINISHES

Bianco/white - glossy

Le Terre di Cielo

<input type="radio"/> TL - Talco	<input type="radio"/> AN - Arenaria
<input type="radio"/> PM - Pomice	<input type="radio"/> AV - Avena
<input type="radio"/> BR - Brina	<input type="radio"/> LN - Lino
<input type="radio"/> BA - Basalto	<input type="radio"/> AG - Agave
<input type="radio"/> LV - Lavagna	<input type="radio"/> MU - Muschio
<input type="radio"/> CM - Cemento	<input type="radio"/> PL - Polvere
<input type="radio"/> FN - Fango	<input type="radio"/> CP - Cipria
<input type="radio"/> CA - Cacao	<input type="radio"/> CN - Canapa

Le Acque di Cielo

<input type="radio"/> OL - Oltremare	<input type="radio"/> CO - Corallo
<input type="radio"/> SM - Smeraldo	<input type="radio"/> NI - Ninfea
<input type="radio"/> AL - Alga	<input type="radio"/> AM - Anemone

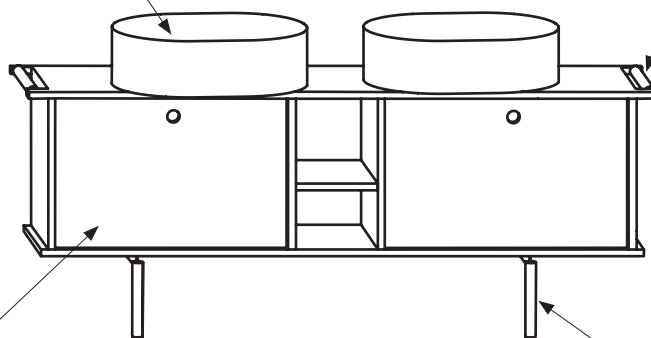

art. **THPL**

**FINITURE PORTASCIUGAMANI**  
TOWEL RAIL FINISHES

verniciature\_coatings

<input type="radio"/> NM - Nero Matt
<input type="radio"/> CM - Cemento

Le Acque di Cielo

<input type="radio"/> OL - Oltremare	<input type="radio"/> CO - Corallo
<input type="radio"/> SM - Smeraldo	<input type="radio"/> NI - Ninfea
<input type="radio"/> AL - Alga	<input type="radio"/> AM - Anemone

art. **THMF175C2/THMF175C2SF**

**FINITURE MOBILE IN FENIX**  
FENIX CABINET FINISHES

<input type="radio"/> FGR - Grafite
<input type="radio"/> FTI - Titanio
<input type="radio"/> FJU - Juta
<input type="radio"/> FCO - Cotone
<input type="radio"/> FZO - Zolfo
<input type="radio"/> FFE - Felce
<input type="radio"/> FCB - Cobalto
<input type="radio"/> FCA - Carminio

art. **THGA**

**FINITURE GAMBA METALLICA**  
METAL LEG FINISHES

verniciature\_coatings

<input type="radio"/> NM - Nero Matt
<input type="radio"/> CM - Cemento

Le Acque di Cielo

<input type="radio"/> OL - Oltremare	<input type="radio"/> CO - Corallo
<input type="radio"/> SM - Smeraldo	<input type="radio"/> NI - Ninfea
<input type="radio"/> AL - Alga	<input type="radio"/> AM - Anemone

**LAVABI ABBINABILI**  
MATCHING WASHBASINS



art. **THLAT**



art. **THLAO**

**DATA**  
DATE

**FIRMA DEL CLIENTE**  
SIGNATURE

**ATTENZIONE:**  
La rappresentazione delle finiture è puramente indicativa. Verificare le finiture con le relative cartelle.

**ATTENTION:**  
The representation of the finishes is merely indicative. Please choose the finishes using the folders.



































Ogni oggetto possiede la peculiarità di essere elaborato secondo principi puramente tradizionali, in modo da garantirne l'assoluta originalità ed unicità. Le eventuali piccole variazioni di colore, tono o venature fra gli articoli sono da considerarsi pregi e non difetti, in quanto garanzia della fattura manuale del prodotto, che fa di ogni oggetto Cielo un pezzo unico ed esclusivo, lontano dall'omologazione industriale. In fase d'ordine si intendono, pertanto, accettate tali tolleranze che non possono dare adito a contestazioni di alcun genere.

Every item possesses that particular feature of being processed according to purely traditional principles that guarantee its absolute originality and uniqueness. The small variations in colour, hues or streaks on the items are to be considered as qualities and not defects, since they warranty the handcrafted processing which makes each Cielo item a unique and exclusive piece that cannot be compared to industrial standardization. When making the order, the client implicitly accepts those various features that may give rise to claims of any sort.

Verificare sempre le disponibilità e i tempi di consegna con il commerciale.

Always check the availability and delivery time with the commercial department.



	Size (cm) Medidas Dimensions Maße Размеры	Product code Artículo Article Artikel Артикул	Net weight (Kg) Peso neto Poids net Reingewicht вес нетто	Finishes Acabados Finitions Farbe Отделки	Euro Евро	Pz. pallet Italia	Pz. pallet Cont.
 <p><b>Round Theo washbasin</b> Lavabo Theo ronda \ Lavabo Theo tour \ Aufsatzbecken Runde Theo \ Theo Раковина круглый</p>	 <p>ø40 x 16 h</p>	THLAT(X)*	8,50	 Gloss White  Le Terre di Cielo  Le Acque di Cielo	457,00 723,00 723,00	24	48
 <p><b>Oval Theo washbasin</b> Lavabo Theo oval \ Lavabo Theo ovale \ Aufsatzbecken Oval Theo \ Раковина овальный Theo</p>	 <p>55 x 40 x 16 h</p>	THLAO(X)*	10,50	 Gloss White  Le Terre di Cielo  Le Acque di Cielo	688,00 896,00 896,00	14	21
 <p><b>Universal click/clack drain in CHROME with ceramic lid</b> Válvula universal click/clack Cromado con tapa en cerámica Bonde universelle clic/clac Chromé avec clapet en céramique Universal-Abflussgarnitur Click-Clack Chrom mit Keramikstopfen Универсальный донный клапан click/clack хром с керамической крышкой</p>		PIL01(X)*	0,40	 Gloss White  Le Terre di Cielo  Le Acque di Cielo	95,00 139,00 139,00		
 <p><b>Universal click/clack drain in BLACK MATT finish with ceramic lid</b> Válvula universal click/clack Negro Matt con tapa en cerámica Bonde universelle clic/clac Noir Mat avec clapet en céramique Universal-Abflussgarnitur Click-Clack Matt Schwarz mit Keramikstopfen Универсальный донный клапан click/clack черный матовый с керамической крышкой</p>		PIL01NM(X)*	0,40	 Gloss White  Le Terre di Cielo  Le Acque di Cielo	120,00 169,00 169,00		
 <p><b>Universal click/clack drain in CEMENTO finish with ceramic lid</b> Válvula universal click/clack Cemento con tapa en cerámica Bonde universelle clic/clac Cemento avec clapet en céramique Universal-Abflussgarnitur Click-Clack Cement mit Keramikstopfen Универсальный донный Cemento click/clack с керамической крышкой</p>		PIL01CM(X)*	0,40	 Gloss White  Le Terre di Cielo  Le Acque di Cielo	120,00 169,00 169,00		
 <p><b>Universal click/clack drain in BRONZE with ceramic lid</b> Válvula universal click/clack Bronce con tapa en cerámica Bonde universelle clic/clac Bronze avec clapet en céramique Universal-Abflussgarnitur Click-Clack Bronze mit Keramikstopfen Универсальный донный клапан click/clack бронза с керамической крышкой</p>		PIL01BR(X)*	0,40	 Gloss White  Le Terre di Cielo  Le Acque di Cielo	135,00 182,00 182,00		
 <p><b>CHROMED siphon</b> Sifone Cromado \ Siphon Chromé \ Siphon Verchromt \ сифон Chrome</p>		SISP	0,93	 Chrome	133,00		
 <p><b>MATT BLACK siphon</b> Sifone Negro Mate \ Siphon Noir Mat \ Siphon Schwarz Matt \ Сифон Черный матовый</p>		SIFN	0,93	 Matt Black	194,00		
 <p><b>CEMENTO siphon</b> Sifone Cemento \ Siphon Cemento \ Siphon Cemento \ сифон Cemento</p>		SIFCM	0,93	 Cemento	194,00		
 <p><b>BRONZE siphon</b> Sifone Bronce \ Siphon Bronze \ Siphon Bronze \ бронза сифон</p>		SIFBR	0,93	 Bronze	220,00		

Technical symbols legend / Símbolos técnicos clave / Légende symboles techniques / Technische Zeichenerklärung / Перечень технических символов

 <p><b>all sides are enamelled</b> con todos los lados esmaltados avec tous les côtés émaillés alle Seiten glasiert все стороны покрыты эмалью</p>	 <p><b>on top installation</b> installation à partir du plan Montage auf Platte установка на столешницу</p>	 <p><b>without overflow</b> sin rebosadero sans trop-plein ohne Überlauf без слива-перелива</p>	 <p><b>no tap holes</b> sin agujero para grifo sans orifice robinet ohne Hahnloch без отверстия под смеситель</p>
---	--	--	--

Le Terre di Cielo	 TL - Talco	 PM - Pomice	 BR - Brina	 BA - Basalto	 LV - Lavagna	 CM - Cemento	 FN - Fango	 CA - Cacao
	 AN - Arenaria	 AV - Avena	 LN - Lino	 AG - Agave	 MU - Muschio	 PL - Polvere	 CP - Cipria	 CN - Canapa
Le Acque di Cielo	 OL - Oltremare	 SM - Smeraldo	 AL - Alga	 CO - Corallo	 NI - Ninfea	 AM - Anemone		

	Size (cm) Medidas Dimensions Maße Размеры	Product code Artículo Article Artikel Артикул	Net weight (Kg) Peso neto poids net Reingewicht вес нетто	Finishes Acabados Finitions Farbe Отделка	Euro Евро	Pz. pallet Italia	Pz. pallet Cont.
 <b>Round washbasin with one hole</b> Lavabo ronda con 1 agujero \ Lavabo tour monotrou \ Aufsatzbecken Runde 1-Loch \ Раковина круглый одно отверстие под смеситель	ø28 x 11,5 h	LPLAT(X)* <b>with tap hole ø25</b> orificio para grifo ø25 trou de robinetterie ø25 Hahnloch ø25 / отверстие под смеситель ø25 ..... LPLATFG(X)* <b>with tap hole ø35</b> orificio para grifo ø35 trou de robinetterie ø35 Hahnloch ø35 / отверстие под смеситель ø35 ..... LPLATSF(X)* <b>no tap hole</b> sin agujero / sans orifice / ohne Loch / без отверстия	4,00	 <b>Gloss White</b>  <b>Le Terre di Cielo</b>  <b>Le Acque di Cielo</b>	<b>277,00</b> <b>413,00</b> <b>413,00</b>	84	126
 <b>Square washbasin with one hole</b> Lavabo cuadrato con 1 agujero \ Lavabo carré monotrou \ Aufsatzbecken quadratisch 1-Loch \ Раковина квадрат одно отверстие под смеситель	28 x 28 x 11,5 h	LPLAQ(X)* <b>with tap hole ø25</b> orificio para grifo ø25 trou de robinetterie ø25 Hahnloch ø25 / отверстие под смеситель ø25 ..... LPLAQFG(X)* <b>with tap hole ø35</b> orificio para grifo ø35 trou de robinetterie ø35 Hahnloch ø35 / отверстие под смеситель ø35 ..... LPLAQSF(X)* <b>no tap hole</b> sin agujero / sans orifice / ohne Loch / без отверстия	4,00	 <b>Gloss White</b>  <b>Le Terre di Cielo</b>  <b>Le Acque di Cielo</b>	<b>277,00</b> <b>413,00</b> <b>413,00</b>	84	126
 <b>Oval washbasin with one hole</b> Lavabo ovalado con 1 agujero grifería \ Lavabo ovale monotrou \ Ovale Waschbecken in 1-Loch-Ausführung \ Раковина овальная с 1 отверстием под смеситель	33,5 x 18,5 x 11,5 h	LPLAO(X)* <b>with tap hole ø25</b> orificio para grifo ø25 trou de robinetterie ø25 Hahnloch ø25 / отверстие под смеситель ø25 ..... LPLAOF(X)* <b>with tap hole ø35</b> orificio para grifo ø35 trou de robinetterie ø35 Hahnloch ø35 / отверстие под смеситель ø35 ..... LPLAOSF(X)* <b>no tap hole</b> sin agujero / sans orifice / ohne Loch / без отверстия	4,00	 <b>Gloss White</b>  <b>Le Terre di Cielo</b>  <b>Le Acque di Cielo</b>	<b>335,00</b> <b>450,00</b> <b>450,00</b>	60	100
 <b>Rectangular washbasin with one hole</b> Lavabo rectangular con 1 agujero \ Lavabo rectangulaire monotrou \ Rechteckiger Waschbecken in 1-Loch-Ausführung \ Раковина прямоугольная с 1 отверстием под смеситель	33,5 x 18,5 x 11,5 h	LPLAR(X)* <b>with tap hole ø25</b> orificio para grifo ø25 trou de robinetterie ø25 Hahnloch ø25 / отверстие под смеситель ø25 ..... LPLARFG(X)* <b>with tap hole ø35</b> orificio para grifo ø35 trou de robinetterie ø35 Hahnloch ø35 / отверстие под смеситель ø35 ..... LPLARSF(X)* <b>no tap hole</b> sin agujero / sans orifice / ohne Loch / без отверстия	4,00	 <b>Gloss White</b>  <b>Le Terre di Cielo</b>  <b>Le Acque di Cielo</b>	<b>335,00</b> <b>450,00</b> <b>450,00</b>	60	100
 <b>Minimo round washbasin</b> Lavabo Minimo ronda Lavabo Minimo tour Aufsatzbecken Runde Minimo Раковина круглый Minimo	25 x 25 x 11,5 h	MILAT(X)*	3,15	 <b>Gloss White</b>  *X = N - Gloss Black  <b>Le Terre di Cielo</b>  <b>Le Acque di Cielo</b>	<b>277,00</b> <b>413,00</b> <b>413,00</b> <b>413,00</b>	152	304
 <b>Minimo square washbasin</b> Lavabo Minimo cuadrato Lavabo Minimo carré Aufsatzbecken quadratisch Minimo Раковина квадрат Minimo	25 x 25 x 11,5 h	MILAQ(X)*	3,15	 <b>Gloss White</b>  *X = N - Gloss Black  <b>Le Terre di Cielo</b>  <b>Le Acque di Cielo</b>	<b>277,00</b> <b>413,00</b> <b>413,00</b> <b>413,00</b>	152	304

### Technical symbols legend

Simbolos técnicos clave | Légende symboles techniques | Technische Zeichenerklärung | Перечень технических символов











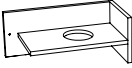

























 <b>all sides are enamelled</b> con todos los lados esmaltados avec tous les côtés émaillés alle Seiten glasiert все стороны покрыты эмалью	 <b>one tap hole</b> con 1 agujero monotrou 1-Loch одно отверстие под смеситель	 <b>no tap hole on request</b> sin agujero, solo a petición sans orifice sur demande auf Anfrage ohne Loch без отверстия под смеситель по запросу	 <b>no tap holes</b> sin agujero para grifo sans orifice robinet ohne Hahnloch без отверстия под смеситель	 <b>without overflow</b> sin rebosadero sans trop-plein ohne Überlauf без слива-перелива	 <b>on top installation</b> instalación de apoyo installation à partir du plan Montage auf Platte установка на столешницу
--	---	--	---	---	--



# Theo Mini

drains and siphons / desagües y sifones / les drains et les siphons / Ablaufgarnituren und Siphons / Донные клапаны и сифоны

# cielo

	Size (cm) Medidas Dimensions Maße Размеры	Product code Artículo Article Artikel Артикул	Net weight (kg) Peso neto Poids net Reingewicht вес нетто	Finishes Acabados Finitions Farbe Отделка	Euro Евро
 <p><b>Theo Mini cabinet in Fenix</b> Mueble Theo Mini en Fenix Meuble Theo Mini en Fenix Möbel Theo Mini aus Fenix Мебельная композиция Theo Mini из материала Fenix</p>	55 x 31 x 24 h	THMF55(x)*	5,00	<ul style="list-style-type: none"> <li> *X = FGR - Grafite</li> <li> *X = FTI - Titanio</li> <li> *X = FJU - Juta</li> <li> *X = FCO - Cotone</li> <li> *X = FCA - Carminio</li> <li> *X = FZO - Zolfo</li> <li> *X = FFE - Felce</li> <li> *X = FCB - Cobalto</li> </ul>	965,00
 <p><b>Towel rail</b> Toallero \ porte-serviette \ Handtuchhalter Полотенцедержатель</p>	29 x ø3	THPL55(x)*	0,35	<ul style="list-style-type: none"> <li> *X = NM - Matt Black</li> <li> *X = CM - Cemento</li> <li> Le Acque di Cielo</li> </ul>	<p>97,00</p> <p>101,00</p> <p>108,00</p>
 <p><b>Universal click/clack drain in CHROME with ceramic lid</b> Válvula universal click/clack Cromado con tapa en cerámica Bonde universelle clic/clac Chromé avec clapet en céramique Universal-Ablaufgarnitur Click-Clack Chrom mit Keramikstopfen Универсальный донный клапан click/clack хром с керамической крышкой</p>		PIL01(x)*	0,40	<ul style="list-style-type: none"> <li> Gloss White</li> <li> Le Terre di Cielo</li> <li> Le Acque di Cielo</li> </ul>	<p>95,00</p> <p>139,00</p> <p>139,00</p>
 <p><b>Universal click/clack drain in BLACK MATT finish with ceramic lid</b> Válvula universal click/clack Negro Matt con tapa en cerámica Bonde universelle clic/clac Noir Mat avec clapet en céramique Universal-Ablaufgarnitur Click-Clack Matt Schwarz mit Keramikstopfen Универсальный донный клапан click/clack черный матовый с керамической крышкой</p>		PIL01NM(x)*	0,40	<ul style="list-style-type: none"> <li> Gloss White</li> <li> Le Terre di Cielo</li> <li> Le Acque di Cielo</li> </ul>	<p>120,00</p> <p>169,00</p> <p>169,00</p>
 <p><b>Universal click/clack drain in CEMENTO finish with ceramic lid</b> Válvula universal click/clack Cemento con tapa en cerámica Bonde universelle clic/clac Cemento avec clapet en céramique Universal-Ablaufgarnitur Click-Clack Cement mit Keramikstopfen Универсальный донный Cemento click/clack с керамической крышкой</p>		PIL01CM(x)*	0,40	<ul style="list-style-type: none"> <li> Gloss White</li> <li> Le Terre di Cielo</li> <li> Le Acque di Cielo</li> </ul>	<p>120,00</p> <p>169,00</p> <p>169,00</p>
 <p><b>Universal click/clack drain in BRONZE with ceramic lid</b> Válvula universal click/clack Bronce con tapa en cerámica Bonde universelle clic/clac Bronze avec clapet en céramique Universal-Ablaufgarnitur Click-Clack Bronze mit Keramikstopfen Универсальный донный клапан click/clack бронза с керамической крышкой</p>		PIL01BR(x)*	0,40	<ul style="list-style-type: none"> <li> Gloss White</li> <li> Le Terre di Cielo</li> <li> Le Acque di Cielo</li> </ul>	<p>135,00</p> <p>182,00</p> <p>182,00</p>
 <p><b>CHROMED siphon</b> Sifone Cromado \ Siphon Chromé \ Siphon Verchromt \ сифон Chrome</p>		SISP	0,93	<ul style="list-style-type: none"> <li> Chrome</li> </ul>	133,00
 <p><b>MATT BLACK siphon</b> Sifone Negro Mate \ Siphon Noir Mat \ Siphon Schwarz Matt \ Сифон Черный матовый</p>		SIFN	0,93	<ul style="list-style-type: none"> <li> Matt Black</li> </ul>	194,00
 <p><b>CEMENTO siphon</b> Sifone Cemento \ Siphon Cemento \ Siphon Cemento \ сифон Cemento</p>		SIFCM	0,93	<ul style="list-style-type: none"> <li> Cemento</li> </ul>	194,00
 <p><b>BRONZE siphon</b> Sifone Bronce \ Siphon Bronze \ Siphon Bronze \ бронза сифон</p>		SIFBR	0,93	<ul style="list-style-type: none"> <li> Bronze</li> </ul>	220,00







**mandatory composition: cabinet + towel rail**  
Composición obligatoria: mueble + toallero / Composition obligatoire: meuble + porte-serviette \ Obligatorische Kombination: Möbel + Handtuchhalter  
\ Обязательная комплектация: мебель + полотенцедержатели

Terre di Cielo available for washbasins / Terre di Cielo disponibles para el lavabo / Terre di Cielo disponibles pour le lavabo / Für Waschbecken erhältliche Terre di Cielo / Отделку Terre di Cielo доступны для раковины

 TL - Talco	 PM - Pomice	 BR - Brina	 BA - Basalto	 LV - Lavagna	 CM - Cemento
 FN - Fango	 CA - Cacao	 AN - Arenaria	 AV - Avena	 LN - Lino	 AG - Agave
 MU - Muschio	 PL - Polvere	 CP - Cipria	 CN - Canapa		

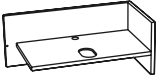
Acque di Cielo available for washbasins and towel rail / Acque di Cielo disponibles para el lavabo y toallero / Acque di Cielo disponibles pour le lavabo et porte-serviette / Für Waschbecken und Handtuchhalter erhältliche Acque di Cielo / Отделку Acque di Cielo доступны для раковины и Полотенцедержатель

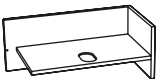
 OL - Oltremare	 SM - Smeraldo	 AL - Alga	 CO - Corallo	 NI - Ninfea	 AM - Anemone
--	---	---	--	---	--

	<b>Size (cm)</b> Medidas Dimensions Maße Размеры	<b>Product code</b> Artículo Article Artikel Артикул	<b>Net weight (Kg)</b> Peso neto Poids net Reingewicht вес нетто	<b>Finishes</b> Acabados Finitions Farbe Отделка	<b>Euro</b> Евро
 <p><b>Round Theo washbasin</b>                      Lavabo Theo ronda \ Lavabo Theo tour \ Aufsatzbecken Runde Theo \ Theo Раковина круглый</p> <p> <input type="checkbox"/> <input checked="" type="checkbox"/> <input checked="" type="checkbox"/> <input type="checkbox"/> </p> <p> <b>Round Theo washbasin</b>                      Lavabo Theo ronda \ Lavabo Theo tour \ Aufsatzbecken Runde Theo \ Theo Раковина круглый</p>	ø40 x 16 h	THLAT(X)*	8,50	<ul style="list-style-type: none"> <li><input type="radio"/> <b>Gloss White</b></li> <li><input type="radio"/> <b>Le Terre di Cielo</b></li> <li><input type="radio"/> <b>Le Acque di Cielo</b></li> </ul>	457,00 723,00 723,00
 <p><b>Theo 70 cabinet in Fenix</b>                      Mueble Theo 70 en Fenix \ Meuble Theo 70 en Fenix \ Möbel Theo 70 aus Fenix ohne Hahnloch \ Мебельная композиция Theo 70 из материала Fenix</p> <p></p>	72 x 38 x 29h	THMF70(X)*	8,50	<ul style="list-style-type: none"> <li><input checked="" type="radio"/> *X = FGR - Grafite</li> <li><input checked="" type="radio"/> *X = FTI - Titanio</li> <li><input checked="" type="radio"/> *X = FJU - Juta</li> <li><input checked="" type="radio"/> *X = FCO - Cotone</li> <li><input checked="" type="radio"/> *X = FCA - Carminio</li> <li><input checked="" type="radio"/> *X = FZO - Zolfo</li> <li><input checked="" type="radio"/> *X = FFE - Felce</li> <li><input checked="" type="radio"/> *X = FCB - Cobalto</li> </ul>	1381,00
 <p><b>Theo 70 cabinet in Fenix without tap hole</b>                      Mueble Theo 70 en Fenix sin agujero griferia \ Meuble Theo 70 en Fenix sans trou de robinetterie \ Möbel Theo 70 aus Fenix ohne Hahnloch \ Мебельная композиция Theo 70 из материала Fenix без отверстия под смеситель</p> <p></p>	72 x 38 x 29h	THMF70SF(X)* no tap hole sin agujero - sans orifice - ohne Loch без отверстия	8,50	<ul style="list-style-type: none"> <li><input checked="" type="radio"/> *X = FGR - Grafite</li> <li><input checked="" type="radio"/> *X = FTI - Titanio</li> <li><input checked="" type="radio"/> *X = FJU - Juta</li> <li><input checked="" type="radio"/> *X = FCO - Cotone</li> <li><input checked="" type="radio"/> *X = FCA - Carminio</li> <li><input checked="" type="radio"/> *X = FZO - Zolfo</li> <li><input checked="" type="radio"/> *X = FFE - Felce</li> <li><input checked="" type="radio"/> *X = FCB - Cobalto</li> </ul>	1381,00
 <p><b>Towel rail</b>                      Toallero \ porte-serviette \ Handtuchhalter \ Полотенцедержатель</p>	36 x ø3	THPL70(X)*	0,40	<ul style="list-style-type: none"> <li><input checked="" type="radio"/> *X = NM - Matt Black</li> <li><input checked="" type="radio"/> *X = CM - Cemento</li> <li><input checked="" type="radio"/> <b>Le Acque di Cielo</b></li> </ul>	101,00 104,00 112,00

 **mandatory composition: cabinet + towel rail + art. THKIT.**

Composición obligatoria: mueble + toallero + art. THKIT \ Composition obligatoire: meuble + porte-serviette + THKIT \ Obligatorische Kombination: Möbel + Handtuchhalter + THKIT  
 Обязательная комплектация: мебель + полотенцедержатели + THKIT

**Technical symbols legend**  
 Símbolos técnicos clave | Légende symboles techniques | Technische Zeichenerklärung | Перечень технических символов

























 **all sides are enamelled**  
 con todos los lados esmaltados  
 avec tous les côtés émaillés  
 alle Seiten glasiert  
 все стороны покрыты эмалью

 **no tap holes**  
 sin agujero para grifo  
 sans orifice robinet  
 ohne Hahnloch  
 без отверстия под смеситель

 **without overflow**  
 sin rebosadero  
 sans trop-plein  
 ohne Überlauf  
 без слива-перелива

 **on top installation**  
 instalación de apoyo  
 installation à partir du plan  
 Montage auf Platte  
 установка на столешницу







	Product code Artículo Article Artikel Артикул	Net weight (Kg) Peso neto Poids net Reingewicht вес нетто	Finishes Acabados Finitions Farbe Отделки	Euro Евро
 <p><b>Universal click/clack drain in CHROME with ceramic lid</b> Válvula universal click/clack Cromado con tapa en cerámica Bonde universelle clic/clac Chromé avec clapet en céramique Universal-Ablaufgarnitur Click-Clack Chrom mit Keramikstopfen Универсальный донный клапан click/clack хром с керамической крышкой</p>	PIL01(X)*	0,40	 Gloss White  Le Terre di Cielo  Le Acque di Cielo	95,00 139,00 139,00
 <p><b>Universal click/clack drain in BLACK MATT finish with ceramic lid</b> Válvula universal click/clack Negro Matt con tapa en cerámica Bonde universelle clic/clac Noir Mat avec clapet en céramique Universal-Ablaufgarnitur Click-Clack Matt Schwarz mit Keramikstopfen Универсальный донный клапан click/clack черный матовый с керамической крышкой</p>	PIL01NM(X)*	0,40	 Gloss White  Le Terre di Cielo  Le Acque di Cielo	120,00 169,00 169,00
 <p><b>Universal click/clack drain in CEMENTO finish with ceramic lid</b> Válvula universal click/clack Cemento con tapa en cerámica Bonde universelle clic/clac Cemento avec clapet en céramique Universal-Ablaufgarnitur Click-Clack Cement mit Keramikstopfen Универсальный донный Cemento click/clack с керамической крышкой</p>	PIL01CM(X)*	0,40	 Gloss White  Le Terre di Cielo  Le Acque di Cielo	120,00 169,00 169,00
 <p><b>Universal click/clack drain in BRONZE with ceramic lid</b> Válvula universal click/clack Bronce con tapa en cerámica Bonde universelle clic/clac Bronze avec clapet en céramique Universal-Ablaufgarnitur Click-Clack Bronze mit Keramikstopfen Универсальный донный клапан click/clack бронза с керамической крышкой</p>	PIL01BR(X)*	0,40	 Gloss White  Le Terre di Cielo  Le Acque di Cielo	135,00 182,00 182,00
 <p><b>CHROMED siphon</b> Sifone Cromado \ Siphon Chromé \ Siphon Verchromt \ сифон Chrome</p>	SISP	0,93	 Chrome	133,00
 <p><b>MATT BLACK siphon</b> Sifone Negro Mate \ Siphon Noir Mat \ Siphon Schwarz Matt \ Сифон Черный матовый</p>	SIFN	0,93	 Matt Black	194,00
 <p><b>CEMENTO siphon</b> Sifone Cemento \ Siphon Cemento \ Siphon Cemento \ сифон Cemento</p>	SIFCM	0,93	 Cemento	194,00
 <p><b>BRONZE siphon</b> Sifone Bronce \ Siphon Bronze \ Siphon Bronze \ бронза сифон</p>	SIFBR	0,93	 Bronze	220,00
 <p><b>Theo washbasin fixing kit (mandatory)</b> Kit fijación lavabo Theo (obligatorio) Kit de fixation du lavabo Theo (obligatoire) Befestigungsset Waschbecken Theo (obligatorisch) Крепежи для раковины Theo (обязательно)</p>	THKIT	0,30		99,00

Terre di Cielo available for washbasins / Terre di Cielo disponibles para el lavabo / Terre di Cielo disponibles pour le lavabo / Für Waschbecken erhältliche Terre di Cielo / Отделку Terre di Cielo доступны для раковины

-  TL - Talco
-  PM - Pomice
-  BR - Brina
-  BA - Basalto
-  LV - Lavagna
-  CM - Cemento
-  FN - Fango
-  CA - Cacao
-  AN - Arenaria
-  AV - Avena
-  LN - Lino
-  AG - Agave
-  MU - Muschio
-  PL - Polvere
-  CP - Cipria
-  CN - Canapa

Acque di Cielo available for washbasins and towel rail / Acque di Cielo disponibles para el lavabo y toallero / Acque di Cielo disponibles pour le lavabo et porte-serviette / Für Waschbecken und Handtuchhalter erhältliche Acque di Cielo / Отделку Acque di Cielo доступны для раковины и Полотенцедержатель

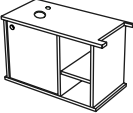
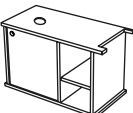
-  OL - Oltremare
-  SM - Smeraldo
-  AL - Alga
-  CO - Corallo
-  NI - Ninfea
-  AM - Anemone

	<b>Size (cm)</b> Medidas Dimensions Maße Размеры	<b>Product code</b> Artículo Article Artikel Артикул	<b>Net weight (kg)</b> Peso neto Poids net Reingewicht вес нетто	<b>Finishes</b> Acabados Finitions Farbe Отделки	<b>Euro</b> Евро
 <p><b>Round Theo washbasin</b>                      Lavabo Theo ronda \ Lavabo Theo tour \ Aufsatzbecken                      Runde Theo \ Theo Раковина круглый</p>	ø40 x 16 h	THLAT(X)*	8,50	<ul style="list-style-type: none"> <li><span style="display: inline-block; width: 10px; height: 10px; background-color: white; border: 1px solid black; border-radius: 50%; margin-right: 5px;"></span> <b>Gloss White</b></li> <li><span style="display: inline-block; width: 10px; height: 10px; background-color: #8B4513; border: 1px solid black; border-radius: 50%; margin-right: 5px;"></span> <b>Le Terre di Cielo</b></li> <li><span style="display: inline-block; width: 10px; height: 10px; background-color: #008080; border: 1px solid black; border-radius: 50%; margin-right: 5px;"></span> <b>Le Acque di Cielo</b></li> </ul>	457,00 723,00 723,00
 <p><b>Theo 78 cabinet in Fenix</b>                      Mueble Theo 78 en Fenix \ Meuble Theo 78 en Fenix \                      Möbel Theo 78 aus Fenix \ Мебельная композиция                      Theo 78 из материала Fenix</p>	78 x 38 x 47h	THMF78(X)*	23,50	<ul style="list-style-type: none"> <li><span style="display: inline-block; width: 10px; height: 10px; background-color: #333; border: 1px solid black; border-radius: 50%; margin-right: 5px;"></span> *X = FGR - Grafite</li> <li><span style="display: inline-block; width: 10px; height: 10px; background-color: #666; border: 1px solid black; border-radius: 50%; margin-right: 5px;"></span> *X = FTI - Titanio</li> <li><span style="display: inline-block; width: 10px; height: 10px; background-color: #A52A2A; border: 1px solid black; border-radius: 50%; margin-right: 5px;"></span> *X = FJU - Juta</li> <li><span style="display: inline-block; width: 10px; height: 10px; background-color: #F5DEB3; border: 1px solid black; border-radius: 50%; margin-right: 5px;"></span> *X = FCO - Cotone</li> <li><span style="display: inline-block; width: 10px; height: 10px; background-color: #8B0000; border: 1px solid black; border-radius: 50%; margin-right: 5px;"></span> *X = FCA - Carminio</li> <li><span style="display: inline-block; width: 10px; height: 10px; background-color: #FFA500; border: 1px solid black; border-radius: 50%; margin-right: 5px;"></span> *X = FZO - Zolfo</li> <li><span style="display: inline-block; width: 10px; height: 10px; background-color: #3CB371; border: 1px solid black; border-radius: 50%; margin-right: 5px;"></span> *X = FFE - Felce</li> <li><span style="display: inline-block; width: 10px; height: 10px; background-color: #4682B4; border: 1px solid black; border-radius: 50%; margin-right: 5px;"></span> *X = FCB - Cobalto</li> </ul>	3234,00
 <p><b>Theo 78 cabinet in Fenix without tap hole</b>                      Mueble Theo 78 en Fenix sin agujero griferia \ Meuble                      Theo 78 en Fenix sans trou de robinetterie \ Möbel                      Theo 78 aus Fenix ohne Hahnloch \ Мебельная                      композиция Theo 78 из материала Fenix без                      отверстия под смеситель</p>	78 x 38 x 47h	THMF78SF(X)*  no tap hole sin agujero sans orifice ohne Loch без отверстия	23,50	<ul style="list-style-type: none"> <li><span style="display: inline-block; width: 10px; height: 10px; background-color: #333; border: 1px solid black; border-radius: 50%; margin-right: 5px;"></span> *X = FGR - Grafite</li> <li><span style="display: inline-block; width: 10px; height: 10px; background-color: #666; border: 1px solid black; border-radius: 50%; margin-right: 5px;"></span> *X = FTI - Titanio</li> <li><span style="display: inline-block; width: 10px; height: 10px; background-color: #A52A2A; border: 1px solid black; border-radius: 50%; margin-right: 5px;"></span> *X = FJU - Juta</li> <li><span style="display: inline-block; width: 10px; height: 10px; background-color: #F5DEB3; border: 1px solid black; border-radius: 50%; margin-right: 5px;"></span> *X = FCO - Cotone</li> <li><span style="display: inline-block; width: 10px; height: 10px; background-color: #8B0000; border: 1px solid black; border-radius: 50%; margin-right: 5px;"></span> *X = FCA - Carminio</li> <li><span style="display: inline-block; width: 10px; height: 10px; background-color: #FFA500; border: 1px solid black; border-radius: 50%; margin-right: 5px;"></span> *X = FZO - Zolfo</li> <li><span style="display: inline-block; width: 10px; height: 10px; background-color: #3CB371; border: 1px solid black; border-radius: 50%; margin-right: 5px;"></span> *X = FFE - Felce</li> <li><span style="display: inline-block; width: 10px; height: 10px; background-color: #4682B4; border: 1px solid black; border-radius: 50%; margin-right: 5px;"></span> *X = FCB - Cobalto</li> </ul>	3234,00
 <p><b>Towel rail</b>                      Toallero \ porte-serviette                      \ Handtuchhalter \                      Полотенцедержатель</p>	31 x ø3	THPL(X)*	0,35	<ul style="list-style-type: none"> <li><span style="display: inline-block; width: 10px; height: 10px; background-color: black; border: 1px solid black; border-radius: 50%; margin-right: 5px;"></span> *X = NM - Matt Black</li> <li><span style="display: inline-block; width: 10px; height: 10px; background-color: #808080; border: 1px solid black; border-radius: 50%; margin-right: 5px;"></span> *X = CM - Cemento</li> <li><span style="display: inline-block; width: 10px; height: 10px; background-color: #008080; border: 1px solid black; border-radius: 50%; margin-right: 5px;"></span> <b>Le Acque di Cielo</b></li> </ul>	101,00 104,00 112,00
 <p><b>Metal leg</b>                      Pata en metal \ Pied en métal \ Bein aus Metall \                      Ножка металлическая</p>	h24 x 20 x 35	THGA(X)*	1,50	<ul style="list-style-type: none"> <li><span style="display: inline-block; width: 10px; height: 10px; background-color: black; border: 1px solid black; border-radius: 50%; margin-right: 5px;"></span> *X = NM - Matt Black</li> <li><span style="display: inline-block; width: 10px; height: 10px; background-color: #808080; border: 1px solid black; border-radius: 50%; margin-right: 5px;"></span> *X = CM - Cemento</li> <li><span style="display: inline-block; width: 10px; height: 10px; background-color: #008080; border: 1px solid black; border-radius: 50%; margin-right: 5px;"></span> <b>Le Acque di Cielo</b></li> </ul>	195,00 201,00 216,00



























**The furniture is suitable for both floor and hanging installation. Mandatory composition: basin+ furniture + towel rail + art. THKIT. Legs are for floor furniture only.**  
 El mueble está diseñado para instalación tanto a suelo como suspendido. Composición obligatoria: lavabo + mueble + toallero + art. THKIT. \ Las patas son solo para la versión de mueble a suelo. La composition vasque + meuble + porte-serviettes + art. THKIT est obligatoire. Les pieds sont uniquement pour la version au sol. \ Das Möbel ist in Standversion erhältlich und auch für Wandmontage geeignet. Das Möbel besteht obligatorisch aus: Becken + Möbel + Handtuchhalter + THKIT. Die Beine sind nur für die Standversion vorgesehen \ Мебель возможна в двух версиях: напольная и подвесная. Обязательный комплект: раковина + тумба + полотенцесушитель + THKIT. Ножки только для напольной версии.

### Technical symbols legend

*Símbolos técnicos clave | Légende symboles techniques | Technische Zeichenerklärung | Перечень технических символов*

- all sides are enamelled**  
 con todos los lados esmaltados  
 avec tous les côtés émaillés  
 alle Seiten glasiert  
 все стороны покрыты эмалью
- without overflow**  
 sin rebosadero  
 sans trop-plein  
 ohne Überlauf  
 без слива-перелива
- no tap holes**  
 sin agujero para grifo  
 sans orifice robinet  
 ohne Hahnloch  
 без отверстия под смеситель
- on top installation**  
 instalación de apoyo  
 installation à partir du plan  
 Montage auf Platte  
 установка на столешницу



















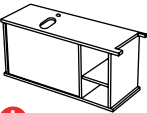







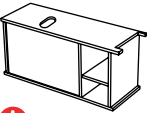





	Product code Artículo Article Artikel Артикул	Net weight (Kg) Peso neto Poids net Reingewicht вес нетто	Finishes Acabados Finitions Farbe Отделки	Euro Евро
 <p><b>Universal click/clack drain in CHROME with ceramic lid</b>                      Válvula universal click/clack Cromado con tapa en cerámica                      Bonde universelle clic/clac Chromé avec clapet en céramique                      Universal-Ablaufgarnitur Click-Clack Chrom mit Keramikstopfen                      Универсальный донный клапан click/clack хром с керамической крышкой</p>	PIL01(X)*	0,40	 <b>Gloss White</b>  <b>Le Terre di Cielo</b>  <b>Le Acque di Cielo</b>	<b>95,00</b> <b>139,00</b> <b>139,00</b>
 <p><b>Universal click/clack drain in BLACK MATT finish with ceramic lid</b>                      Válvula universal click/clack Negro Matt con tapa en cerámica                      Bonde universelle clic/clac Noir Mat avec clapet en céramique                      Universal-Ablaufgarnitur Click-Clack Matt Schwarz mit Keramikstopfen                      Универсальный донный клапан click/clack черный матовый с керамической крышкой</p>	PIL01NM(X)*	0,40	 <b>Gloss White</b>  <b>Le Terre di Cielo</b>  <b>Le Acque di Cielo</b>	<b>120,00</b> <b>169,00</b> <b>169,00</b>
 <p><b>Universal click/clack drain in CEMENTO finish with ceramic lid</b>                      Válvula universal click/clack Cemento con tapa en cerámica                      Bonde universelle clic/clac Cemento avec clapet en céramique                      Universal-Ablaufgarnitur Click-Clack Cement mit Keramikstopfen                      Универсальный донный клапан click/clack с керамической крышкой</p>	PIL01CM(X)*	0,40	 <b>Gloss White</b>  <b>Le Terre di Cielo</b>  <b>Le Acque di Cielo</b>	<b>120,00</b> <b>169,00</b> <b>169,00</b>
 <p><b>Universal click/clack drain in BRONZE with ceramic lid</b>                      Válvula universal click/clack Bronce con tapa en cerámica                      Bonde universelle clic/clac Bronze avec clapet en céramique                      Universal-Ablaufgarnitur Click-Clack Bronze mit Keramikstopfen                      Универсальный донный клапан click/clack бронза с керамической крышкой</p>	PIL01BR(X)*	0,40	 <b>Gloss White</b>  <b>Le Terre di Cielo</b>  <b>Le Acque di Cielo</b>	<b>135,00</b> <b>182,00</b> <b>182,00</b>
 <p><b>CHROMED siphon</b>                      Sifone Cromado \ Siphon Chromé \ Siphon Verchromt \ сифон Chrome</p>	SISP	0,93	 <b>Chrome</b>	<b>133,00</b>
 <p><b>MATT BLACK siphon</b>                      Sifone Negro Mate \ Siphon Noir Mat \ Siphon Schwarz Matt \ Сифон Черный матовый</p>	SIFN	0,93	 <b>Matt Black</b>	<b>194,00</b>
 <p><b>CEMENTO siphon</b>                      Sifone Cemento \ Siphon Cemento \ Siphon Cemento \ сифон Cemento</p>	SIFCM	0,93	 <b>Cemento</b>	<b>194,00</b>
 <p><b>BRONZE siphon</b>                      Sifone Bronce \ Siphon Bronze \ Siphon Bronze \ бронза сифон</p>	SIFBR	0,93	 <b>Bronze</b>	<b>220,00</b>
 <p><b>Theo washbasin fixing kit (mandatory)</b>                      Kit fijación lavabo Theo (obligatorio)                      Kit de fixation du lavabo Theo (obligatoire)                      Befestigungsset Waschbecken Theo (obligatorisch)                      Крепежи для раковины Theo (обязательно)</p>	THKIT	0,30		<b>99,00</b>

**Terre di Cielo available for washbasins** / Terre di Cielo disponibles para el lavabo / Terre di Cielo disponibles pour le lavabo / Für Waschbecken erhältliche Terre di Cielo / Отделка Terre di Cielo доступны для раковины

-  TL - Talco
-  PM - Pomice
-  BR - Brina
-  BA - Basalto
-  LV - Lavagna
-  CM - Cemento
-  FN - Fango
-  CA - Cacao
-  AN - Arenaria
-  AV - Avena
-  LN - Lino
-  AG - Agave
-  MU - Muschio
-  PL - Polvere
-  CP - Cipria
-  CN - Canapa

**Acque di Cielo available for washbasins and towel rail** / Acque di Cielo disponibles para el lavabo y toallero / Acque di Cielo disponibles pour le lavabo et porte-serviette / Für Waschbecken und Handtuchhalter erhältliche Acque di Cielo / Отделка Acque di Cielo доступны для раковины и Полотенцедержатель

-  OL - Oltremare
-  SM - Smeraldo
-  AL - Alga
-  CO - Corallo
-  NI - Ninfea
-  AM - Anemone

	<b>Size (cm)</b> Medidas Dimensions Maße Размеры	<b>Product code</b> Artículo Article Artikel Артикул	<b>Net weight (kg)</b> Peso neto Poids net Reingewicht вес нетто	<b>Finishes</b> Acabados Finitions Farbe Отделка	<b>Euro</b> Евро
 <p><b>Round Theo washbasin</b>                      Lavabo Theo ronda \ Lavabo Theo tour \ Aufsatzbecken Runde Theo \ Theo Раковина круглый</p>	ø40 x 16 h	THLAT(x)*	8,50	<ul style="list-style-type: none"> <li> <b>Gloss White</b></li> <li> <b>Le Terre di Cielo</b></li> <li> <b>Le Acque di Cielo</b></li> </ul>	457,00 723,00 723,00
 <p><b>Oval Theo washbasin</b>                      Lavabo Theo oval \ Lavabo Theo ovale \ Aufsatzbecken Oval Theo \ Раковина овальный Theo</p>	55 x 40 x 16 h	THLAO(x)*	10,50	<ul style="list-style-type: none"> <li> <b>Gloss White</b></li> <li> <b>Le Terre di Cielo</b></li> <li> <b>Le Acque di Cielo</b></li> </ul>	688,00 896,00 896,00
 <p><b>Theo 103 cabinet in Fenix</b>                      Mueble Theo 103 en Fenix \ Meuble Theo 103 en Fenix \ Möbel Theo 103 aus Fenix \ Мебельная композиция Theo 103 из материала Fenix</p>	103 x 38 x 47h	THMF103(x)*	30,00	<ul style="list-style-type: none"> <li> *X = FGR - Grafite</li> <li> *X = FTI - Titanio</li> <li> *X = FJU - Juta</li> <li> *X = FCO - Cotone</li> <li> *X = FCA - Carminio</li> <li> *X = FZO - Zolfo</li> <li> *X = FFE - Felce</li> <li> *X = FCB - Cobalto</li> </ul>	3754,00
 <p><b>Theo 103 cabinet in Fenix without tap hole</b>                      Mueble Theo 103 en Fenix sin agujero grifería \ Meuble Theo 103 en Fenix sans trou de robinetterie \ Möbel Theo 103 aus Fenix ohne Hahnloch \ Мебельная композиция Theo 103 из материала Fenix без отверстия под смеситель</p>	103 x 38 x 47h	THMF103SF(x)* no tap hole sin agujero - sans orifice - ohne Loch без отверстия	30,00	<ul style="list-style-type: none"> <li> *X = FGR - Grafite</li> <li> *X = FTI - Titanio</li> <li> *X = FJU - Juta</li> <li> *X = FCO - Cotone</li> <li> *X = FCA - Carminio</li> <li> *X = FZO - Zolfo</li> <li> *X = FFE - Felce</li> <li> *X = FCB - Cobalto</li> </ul>	3754,00
 <p><b>Towel rail</b>                      Toallero \ porte-serviette \ Handtuchhalter \ Полотенцедержатель</p>	31 x ø3	THPL(x)*	0,35	<ul style="list-style-type: none"> <li> *X = NM - Matt Black</li> <li> *X = CM - Cemento</li> <li> <b>Le Acque di Cielo</b></li> </ul>	101,00 104,00 112,00
 <p><b>Metal leg</b>                      Pata en metal \ Pied en métal \ Bein aus Metall \ Ножка металлическая</p>	h24 x 20 x 35	THGA(x)*	1,50	<ul style="list-style-type: none"> <li> <b>Matt Black</b></li> <li> <b>Cemento</b></li> <li> <b>Le Acque di Cielo</b></li> </ul>	195,00 201,00 216,00



The furniture is suitable for both floor and hanging installation. Mandatory composition: basin+ furniture + towel rail + art. THKIT. Legs are for floor furniture only.  
 El mueble está diseñado para instalación tanto a suelo como suspendido. Composición obligatoria: lavabo + mueble + toallero + art. THKIT. \ Las patas son solo para la versión de mueble a suelo. La composición vasque + mueble + porte-serviettes + art. THKIT est obligatoire. Les pieds sont uniquement pour la version au sol. \ Das Möbel ist in Standversion erhältlich und auch für Wandmontage geeignet. Das Möbel besteht obligatorisch aus: Becken + Möbel + Handtuchhalter + THKIT. Die Beine sind nur für die Standversion vorgesehen \ Мебель возможна в двух версиях: напольная и подвесная. Обязательный комплект: раковина + тумба + полотенцесушитель + THKIT. Ножки только для напольной версии.

### Technical symbols legend

Simbolos técnicos clave | Légende symboles techniques | Technische Zeichenerklärung | Перечень технических символов

 all sides are enamelled  
 con todos los lados esmaltados  
 avec tous les côtés émaillés  
 alle Seiten glasiert  
 все стороны покрыты эмалью

 without overflow  
 sin rebosadero  
 sans trop-plein  
 ohne Überlauf  
 без слива-перелива

























 no tap holes  
 sin agujero para grifo  
 sans orifice robinet  
 ohne Hahnloch  
 без отверстия под смеситель

 on top installation  
 instalación de apoyo  
 installation à partir du plan  
 Montage auf Platte  
 установка на столешницу

# Theo 103

drains and siphons / desagües y sifones / les drains et les siphons / Ablaufgarnituren und Siphons / Донные клапаны и сифоны

# cielo

	<b>Product code</b> Artículo Article Artikel Артикул	<b>Net weight</b> (Kg) Peso neto Poids net Reingewicht вес нетто	<b>Finishes</b> Acabados Finitions Farbe Отделки	<b>Euro</b> Евро
 <p><b>Universal click/clack drain in CHROME with ceramic lid</b> Válvula universal click/clack Cromado con tapa en cerámica Bonde universelle clic/clac Chromé avec clapet en céramique Universal-Ablaufgarnitur Click-Clack Chrom mit Keramikstopfen Универсальный донный клапан click/clack хром с керамической крышкой</p>	PIL01(X)*	0,40	 <b>Gloss White</b>  <b>Le Terre di Cielo</b>  <b>Le Acque di Cielo</b>	<b>95,00</b> <b>139,00</b> <b>139,00</b>
 <p><b>Universal click/clack drain in BLACK MATT finish with ceramic lid</b> Válvula universal click/clack Negro Matt con tapa en cerámica Bonde universelle clic/clac Noir Mat avec clapet en céramique Universal-Ablaufgarnitur Click-Clack Matt Schwarz mit Keramikstopfen Универсальный донный клапан click/clack черный матовый с керамической крышкой</p>	PIL01NM(X)*	0,40	 <b>Gloss White</b>  <b>Le Terre di Cielo</b>  <b>Le Acque di Cielo</b>	<b>120,00</b> <b>169,00</b> <b>169,00</b>
 <p><b>Universal click/clack drain in CEMENTO finish with ceramic lid</b> Válvula universal click/clack Cemento con tapa en cerámica Bonde universelle clic/clac Cemento avec clapet en céramique Universal-Ablaufgarnitur Click-Clack Cement mit Keramikstopfen Универсальный донный клапан click/clack с керамической крышкой</p>	PIL01CM(X)*	0,40	 <b>Gloss White</b>  <b>Le Terre di Cielo</b>  <b>Le Acque di Cielo</b>	<b>120,00</b> <b>169,00</b> <b>169,00</b>
 <p><b>Universal click/clack drain in BRONZE with ceramic lid</b> Válvula universal click/clack Bronce con tapa en cerámica Bonde universelle clic/clac Bronze avec clapet en céramique Universal-Ablaufgarnitur Click-Clack Bronze mit Keramikstopfen Универсальный донный клапан click/clack бронза с керамической крышкой</p>	PIL01BR(X)*	0,40	 <b>Gloss White</b>  <b>Le Terre di Cielo</b>  <b>Le Acque di Cielo</b>	<b>135,00</b> <b>182,00</b> <b>182,00</b>
 <p><b>CHROMED siphon</b> Sifone Cromado \ Siphon Chromé \ Siphon Verchromt \ сифон Chrome</p>	SISP	0,93	 <b>Chrome</b>	<b>133,00</b>
 <p><b>MATT BLACK siphon</b> Sifone Negro Mate \ Siphon Noir Mat \ Siphon Schwarz Matt \ Сифон Черный матовый</p>	SIFN	0,93	 <b>Matt Black</b>	<b>194,00</b>
 <p><b>CEMENTO siphon</b> Sifone Cemento \ Siphon Cemento \ Siphon Cemento \ сифон Cemento</p>	SIFCM	0,93	 <b>Cemento</b>	<b>194,00</b>
 <p><b>BRONZE siphon</b> Sifone Bronce \ Siphon Bronze \ Siphon Bronze \ бронза сифон</p>	SIFBR	0,93	 <b>Bronze</b>	<b>220,00</b>
 <p><b>Theo washbasin fixing kit (mandatory)</b> Kit fijación lavabo Theo (obligatorio) Kit de fixation du lavabo Theo (obligatoire) Befestigungsset Waschbecken Theo (obligatorisch) Крепежи для раковины Theo (обязательно)</p>	THKIT	0,30		<b>99,00</b>

**Terre di Cielo available for washbasins** / Terre di Cielo disponibles para el lavabo / Terre di Cielo disponibles pour le lavabo / Für Waschbecken erhältliche Terre di Cielo / Отделка Terre di Cielo доступны для раковины

-  TL - Talco
-  PM - Pomice
-  BR - Brina
-  BA - Basalto
-  LV - Lavagna
-  CM - Cemento
-  FN - Fango
-  CA - Cacao
-  AN - Arenaria
-  AV - Avena
-  LN - Lino
-  AG - Agave
-  MU - Muschio
-  PL - Polvere
-  CP - Cipria
-  CN - Canapa



















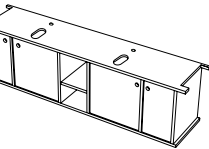







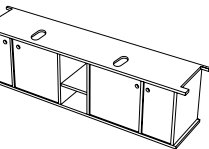





**Acque di Cielo available for washbasins and towel rail** / Acque di Cielo disponibles para el lavabo y toallero / Acque di Cielo disponibles pour le lavabo et porte-serviette / Für Waschbecken und Handtuchhalter erhältliche Acque di Cielo / Отделка Acque di Cielo доступны для раковины и Полотенцедержатель

-  OL - Oltremare
-  SM - Smeraldo
-  AL - Alga
-  CO - Corallo
-  NI - Ninfea
-  AM - Anemone

# Theo 175

with 4 doors and an open compartment | con 4 cajones y un compartimento abierto | avec 4 grands tiroirs et un compartiment ouvert | mit 4 Türen und einem offenen Fach | Мебельная композиция Theo 175 с 4 ящика и открытой полкой

# cielo

	Size (cm) Medidas Dimensions Maße Размеры	Product code Artículo Article Artikel Артикул	Net weight (kg) Peso neto Poids net Reingewicht вес нетто	Finishes Acabados Finitions Farbe Отделка	Euro Евро
 <p><b>Round Theo washbasin</b> Lavabo Theo ronda \ Lavabo Theo tour \ Aufsatzbecken Runde Theo \ Theo Раковина круглый</p>	ø40 x 16 h	THLAT(X)*	8,50	<ul style="list-style-type: none"> <li> <b>Gloss White</b></li> <li> <b>Le Terre di Cielo</b></li> <li> <b>Le Acque di Cielo</b></li> </ul>	<ul style="list-style-type: none"> <li><b>457,00</b></li> <li><b>723,00</b></li> <li><b>723,00</b></li> </ul>
 <p><b>Oval Theo washbasin</b> Lavabo Theo oval \ Lavabo Theo ovale \ Aufsatzbecken Oval Theo \ Раковина овальный Theo</p>	55 x 40 x 16 h	THLAO(X)*	10,50	<ul style="list-style-type: none"> <li> <b>Gloss White</b></li> <li> <b>Le Terre di Cielo</b></li> <li> <b>Le Acque di Cielo</b></li> </ul>	<ul style="list-style-type: none"> <li><b>688,00</b></li> <li><b>896,00</b></li> <li><b>896,00</b></li> </ul>
 <p><b>Theo 175 cabinet with 4 doors and an open compartment</b> Theo 175 con 4 cajones y un compartimento abierto \ Theo 175 avec 4 grands tiroirs et un compartiment ouvert \ Theo 175 mit 4 Türen und einem offenen Fach \ Мебельная композиция Theo 175 с 4 ящика и открытой полкой</p>	175 x 38 x 47h	THMF175A4(X)*	53,00	<ul style="list-style-type: none"> <li> *X = FGR - Grafite</li> <li> *X = FTI - Titanio</li> <li> *X = FJU - Juta</li> <li> *X = FCO - Cotone</li> <li> *X = FCA - Carminio</li> <li> *X = FZO - Zolfo</li> <li> *X = FFE - Felce</li> <li> *X = FCB - Cobalto</li> </ul>	<b>5868,00</b>
 <p><b>Theo 175 cabinet with 4 doors and an open compartment without tap hole</b> Theo 175 con 4 cajones y un compartimento abierto sin agujero griferia \ Theo 175 avec 4 grands tiroirs et un compartiment ouvert sans trou de robinetterie \ Theo 175 mit 4 Türen und einem offenen Fach ohne Hahnloch \ Мебельная композиция Theo 175 с 4 ящика и открытой полкой без отверстия под смеситель</p>	175 x 38 x 47h	THMF175A4SF(X)*	53,00	<ul style="list-style-type: none"> <li> *X = FGR - Grafite</li> <li> *X = FTI - Titanio</li> <li> *X = FJU - Juta</li> <li> *X = FCO - Cotone</li> <li> *X = FCA - Carminio</li> <li> *X = FZO - Zolfo</li> <li> *X = FFE - Felce</li> <li> *X = FCB - Cobalto</li> </ul>	<b>5868,00</b>
 <p><b>Towel rail</b> Toallero \ porte-serviette \ Handtuchhalter \ Полотенцедержатель</p>	31 x ø3	THPL(X)*	0,35	<ul style="list-style-type: none"> <li> *X = NM - Matt Black</li> <li> *X = CM - Cemento</li> <li> <b>Le Acque di Cielo</b></li> </ul>	<ul style="list-style-type: none"> <li><b>101,00</b></li> <li><b>104,00</b></li> <li><b>112,00</b></li> </ul>
 <p><b>Metal leg</b> Pata en metal \ Pied en métal \ Bein aus Metall \ Ножка металлическая</p>	h24 x 20 x 35	THGA(X)*	1,50	<ul style="list-style-type: none"> <li> *X = NM - Matt Black</li> <li> *X = CM - Cemento</li> <li> <b>Le Acque di Cielo</b></li> </ul>	<ul style="list-style-type: none"> <li><b>195,00</b></li> <li><b>201,00</b></li> <li><b>216,00</b></li> </ul>

**The furniture is suitable for both floor and hanging installation. Mandatory composition: basin+ furniture + towel rail + art. THKIT. Legs are for floor furniture only.**  
El mueble está diseñado para instalación tanto a suelo como suspendido. Composición obligatoria: lavabo + mueble + toallero + art. THKIT. \ Las patas son solo para la versión de mueble a suelo. La composition vasque + meuble + porte-serviettes + art. THKIT est obligatoire. Les pieds sont uniquement pour la version au sol. \ Das Möbel ist in Standversion erhältlich und auch für Wandmontage geeignet. Das Möbel besteht obligatorisch aus: Becken + Möbel + Handtuchhalter + THKIT. Die Beine sind nur für die Standversion vorgesehen \ Мебель возможна в двух версиях: напольная и подвесная. Обязательный комплект: раковина + тумба + полотенцесушитель + THKIT. Ножки только для напольной версии.

### Technical symbols legend

Simbolos técnicos clave | Légende symboles techniques | Technische Zeichenerklärung | Перечень технических символов

 all sides are enamelled  
con todos los lados esmaltados  
avec tous les côtés émaillés  
alle Seiten glasiert  
все стороны покрыты эмалью

 without overflow  
sin rebosadero  
sans trop-plein  
ohne Überlauf  
без слива-перелива

























 no tap holes  
sin agujero para grifo  
sans orifice robinet  
ohne Hahnloch  
без отверстия под смеситель

 on top installation  
instalación de apoyo  
installation de apui  
Montage auf Platte  
установка на столешницу

# Theo 175

# cielo

drains and siphons / desagües y sifones / les drains et les siphons / Ablaufgarnituren und Siphons / Донные клапаны и сифоны

	Product code Artículo Article Artikel Артикул	Net weight (Kg) Peso neto Poids net Reingewicht вес нетто	Finishes Acabados Finitions Farbe Отделки	Euro Евро
 <p><b>Universal click/clack drain in CHROME with ceramic lid</b> Válvula universal click/clack Cromado con tapa en cerámica Bonde universelle clic/clac Chromé avec clapet en céramique Universal-Ablaufgarnitur Click-Clack Chrom mit Keramikstopfen Универсальный донный клапан click/clack хром с керамической крышкой</p>	PIL01(X)*	0,40	 <b>Gloss White</b>  <b>Le Terre di Cielo</b>  <b>Le Acque di Cielo</b>	<b>95,00</b> <b>139,00</b> <b>139,00</b>
 <p><b>Universal click/clack drain in BLACK MATT finish with ceramic lid</b> Válvula universal click/clack Negro Matt con tapa en cerámica Bonde universelle clic/clac Noir Mat avec clapet en céramique Universal-Ablaufgarnitur Click-Clack Matt Schwarz mit Keramikstopfen Универсальный донный клапан click/clack черный матовый с керамической крышкой</p>	PIL01NM(X)*	0,40	 <b>Gloss White</b>  <b>Le Terre di Cielo</b>  <b>Le Acque di Cielo</b>	<b>120,00</b> <b>169,00</b> <b>169,00</b>
 <p><b>Universal click/clack drain in CEMENTO finish with ceramic lid</b> Válvula universal click/clack Cemento con tapa en cerámica Bonde universelle clic/clac Cemento avec clapet en céramique Universal-Ablaufgarnitur Click-Clack Cement mit Keramikstopfen Универсальный донный клапан click/clack с керамической крышкой</p>	PIL01CM(X)*	0,40	 <b>Gloss White</b>  <b>Le Terre di Cielo</b>  <b>Le Acque di Cielo</b>	<b>120,00</b> <b>169,00</b> <b>169,00</b>
 <p><b>Universal click/clack drain in BRONZE with ceramic lid</b> Válvula universal click/clack Bronce con tapa en cerámica Bonde universelle clic/clac Bronze avec clapet en céramique Universal-Ablaufgarnitur Click-Clack Bronze mit Keramikstopfen Универсальный донный клапан click/clack бронза с керамической крышкой</p>	PIL01BR(X)*	0,40	 <b>Gloss White</b>  <b>Le Terre di Cielo</b>  <b>Le Acque di Cielo</b>	<b>135,00</b> <b>182,00</b> <b>182,00</b>
 <p><b>CHROMED siphon</b> Sifone Cromado \ Siphon Chromé \ Siphon Verchromt \ сифон Chrome</p>	SISP	0,93	 <b>Chrome</b>	<b>133,00</b>
 <p><b>MATT BLACK siphon</b> Sifone Negro Mate \ Siphon Noir Mat \ Siphon Schwarz Matt \ Сифон Черный матовый</p>	SIFN	0,93	 <b>Matt Black</b>	<b>194,00</b>
 <p><b>CEMENTO siphon</b> Sifone Cemento \ Siphon Cemento \ Siphon Cemento \ сифон Cemento</p>	SIFCM	0,93	 <b>Cemento</b>	<b>194,00</b>
 <p><b>BRONZE siphon</b> Sifone Bronce \ Siphon Bronze \ Siphon Bronze \ бронза сифон</p>	SIFBR	0,93	 <b>Bronze</b>	<b>220,00</b>
 <p><b>Theo washbasin fixing kit (mandatory)</b> Kit fijación lavabo Theo (obligatorio) Kit de fixation du lavabo Theo (obligatoire) Befestigungsset Waschbecken Theo (obligatorisch) Крепежи для раковины Theo (обязательно)</p>	THKIT	0,30		<b>99,00</b>

**Terre di Cielo available for washbasins** / Terre di Cielo disponibles para el lavabo y toallero / Terre di Cielo disponibles pour le lavabo / Für Waschbecken erhältliche Terre di Cielo / Отделка Terre di Cielo доступны для раковины

-  TL - Talco
-  PM - Pomice
-  BR - Brina
-  BA - Basalto
-  LV - Lavagna
-  CM - Cemento
-  FN - Fango
-  CA - Cacao
-  AN - Arenaria
-  AV - Avena
-  LN - Lino
-  AG - Agave
-  MU - Muschio
-  PL - Polvere
-  CP - Cipria
-  CN - Canapa

**Acque di Cielo available for washbasins and towel rail** / Acque di Cielo disponibles para el lavabo y toallero / Acque di Cielo disponibles pour le lavabo et porte-serviette / Für Waschbecken und Handtuchhalter erhältliche Acque di Cielo / Отделка Acque di Cielo доступны для раковины и Полотенцедержатель



















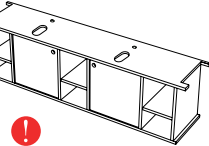







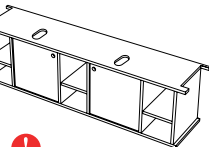





-  OL - Oltremare
-  SM - Smeraldo
-  AL - Alga
-  CO - Corallo
-  NI - Ninfea
-  AM - Anemone



# Theo 175

with 2 doors and 3 open compartments / con 2 puertas y 3 compartimentos abiertos / avec 2 portes et 3 compartiments ouverts / mit 2 Türen und 3 offenen Fächern / Мебельная композиция Theo 175 с 2 дверцами и 3 открытыми полками

# cielo

	<b>Size (cm)</b> Medidas Dimensions Maße Размеры	<b>Product code</b> Artículo Article Artikel Артикул	<b>Net weight (Kg)</b> Peso neto Poids net Reingewicht вес нетто	<b>Finishes</b> Acabados Finitions Farbe Отделка	<b>Euro</b> Евро
 <p><b>Round Theo washbasin</b>                      Lavabo Theo ronda \ Lavabo Theo tour \ Aufsatzbecken Runde Theo \ Theo Раковина круглый</p>	ø40 x 16 h	THLAT(x)*	8,50	<ul style="list-style-type: none"> <li> <b>Gloss White</b></li> <li> <b>Le Terre di Cielo</b></li> <li> <b>Le Acque di Cielo</b></li> </ul>	457,00 723,00 723,00
 <p><b>Oval Theo washbasin</b>                      Lavabo Theo oval \ Lavabo Theo ovale \ Aufsatzbecken Oval Theo \ Раковина овальный Theo</p>	55 x 40 x 16 h	THLAO(x)*	10,50	<ul style="list-style-type: none"> <li> <b>Gloss White</b></li> <li> <b>Le Terre di Cielo</b></li> <li> <b>Le Acque di Cielo</b></li> </ul>	688,00 896,00 896,00
 <p><b>Theo 175 cabinet with 2 doors and 3 open compartments</b>                      Theo 175 Theo 175 con 2 puertas y 3 compartimentos abiertos \ Theo 175 avec 2 portes et 3 compartiments ouverts \ Theo 175 mit 2 Türen und 3 offenen Fächern \ Мебельная композиция Theo 175 с 2 дверцами и 3 открытыми полками</p>	175 x 38 x 47h	THMF175A2(x)*	50,00	<ul style="list-style-type: none"> <li> *X = FGR - Grafite</li> <li> *X = FTI - Titanio</li> <li> *X = FJU - Juta</li> <li> *X = FCO - Cotone</li> <li> *X = FCA - Carminio</li> <li> *X = FZO - Zolfo</li> <li> *X = FFE - Felce</li> <li> *X = FCB - Cobalto</li> </ul>	5706,00
 <p><b>Theo 175 cabinet with 2 doors and 3 open compartments without tap hole</b>                      Theo 175 Theo 175 con 2 puertas y 3 compartimentos abiertos sin agujero grifería \ Theo 175 avec 2 portes et 3 compartiments ouverts sans trou de robinetterie \ Theo 175 mit 2 Türen und 3 offenen Fächern ohne Hahnloch \ Мебельная композиция Theo 175 с 2 дверцами и 3 открытыми полками без отверстия под смеситель</p>	175 x 38 x 47h	THMF175A2SF(x)* no tap hole sin agujero - sans orifice - ohne Loch без отверстия	50,00	<ul style="list-style-type: none"> <li> *X = FGR - Grafite</li> <li> *X = FTI - Titanio</li> <li> *X = FJU - Juta</li> <li> *X = FCO - Cotone</li> <li> *X = FCA - Carminio</li> <li> *X = FZO - Zolfo</li> <li> *X = FFE - Felce</li> <li> *X = FCB - Cobalto</li> </ul>	5706,00
 <p><b>Towel rail</b>                      Toallero \ porte-serviette \ Handtuchhalter \ Полотенцедержатель</p>	31 x ø3	THPL(x)*	0,35	<ul style="list-style-type: none"> <li> *X = NM - Matt Black</li> <li> *X = CM - Cemento</li> <li> <b>Le Acque di Cielo</b></li> </ul>	101,00 104,00 112,00
 <p><b>Metal leg</b>                      Pata en metal \ Pied en métal \ Bein aus Metall \ Ножка металлическая</p>	h24 x 20 x 35	THGA(x)*	1,50	<ul style="list-style-type: none"> <li> <b>Matt Black</b></li> <li> *X = CM - Cemento</li> <li> <b>Le Acque di Cielo</b></li> </ul>	195,00 201,00 216,00

**The furniture is suitable for both floor and hanging installation. Mandatory composition: basin+ furniture + towel rail + art. THKIT. Legs are for floor furniture only.**

El mueble está diseñado para instalación tanto a suelo como suspendido. Composición obligatoria: lavabo + mueble + toallero + art. THKIT. \ Las patas son solo para la versión de mueble a suelo. La composition vasque + meuble + porte-serviettes + art. THKIT est obligatoire. Les pieds sont uniquement pour la version au sol. \ Das Möbel ist in Standversion erhältlich und auch für Wandmontage geeignet. Das Möbel besteht obligatorisch aus: Becken + Möbel + Handtuchhalter + THKIT. Die Beine sind nur für die Standversion vorgesehen \ Мебель возможна в двух версиях: напольная и подвесная. Обязательный комплект: раковина + тумба + полотенцесушитель + THKIT. Ножки только для напольной версии.

### Technical symbols legend

Simbolos técnicos clave / Légende symboles techniques / Technische Zeichenerklärung / Перечень технических символов

 all sides are enamelled  
 con todos los lados esmaltados  
 avec tous les côtés émaillés  
 alle Seiten glasiert  
 все стороны покрыты эмалью

 no tap holes  
 sin agujero para grifo  
 sans orifice robinet  
 ohne Hahnloch  
 без отверстия под смеситель

























 without overflow  
 sin rebosadero  
 sans trop-plein  
 ohne Überlauf  
 без слива-перелива

 on top installation  
 instalación de apoyo  
 installation à partir du plan  
 Montage auf Platte  
 установка на столешницу

# Theo 175

drains and siphons / desagües y sifones / les drains et les siphons / Ablaufgarnituren und Siphons / Донные клапаны и сифоны

# cielo

	Product code Artículo Article Artikel Артикул	Net weight (Kg) Peso neto Poids net Reingewicht вес нетто	Finishes Acabados Finitions Farbe Отделки	Euro Евро
 <p><b>Universal click/clack drain in CHROME with ceramic lid</b> Válvula universal click/clack Cromado con tapa en cerámica Bonde universelle clic/clac Chromé avec clapet en céramique Universal-Ablaufgarnitur Click-Clack Chrom mit Keramikstopfen Универсальный донный клапан click/clack хром с керамической крышкой</p>	PIL01(X)*	0,40	 <b>Gloss White</b>  <b>Le Terre di Cielo</b>  <b>Le Acque di Cielo</b>	<b>95,00</b> <b>139,00</b> <b>139,00</b>
 <p><b>Universal click/clack drain in BLACK MATT finish with ceramic lid</b> Válvula universal click/clack Negro Matt con tapa en cerámica Bonde universelle clic/clac Noir Mat avec clapet en céramique Universal-Ablaufgarnitur Click-Clack Matt Schwarz mit Keramikstopfen Универсальный донный клапан click/clack черный матовый с керамической крышкой</p>	PIL01NM(X)*	0,40	 <b>Gloss White</b>  <b>Le Terre di Cielo</b>  <b>Le Acque di Cielo</b>	<b>120,00</b> <b>169,00</b> <b>169,00</b>
 <p><b>Universal click/clack drain in CEMENTO finish with ceramic lid</b> Válvula universal click/clack Cemento con tapa en cerámica Bonde universelle clic/clac Cemento avec clapet en céramique Universal-Ablaufgarnitur Click-Clack Cement mit Keramikstopfen Универсальный донный клапан click/clack с керамической крышкой</p>	PIL01CM(X)*	0,40	 <b>Gloss White</b>  <b>Le Terre di Cielo</b>  <b>Le Acque di Cielo</b>	<b>120,00</b> <b>169,00</b> <b>169,00</b>
 <p><b>Universal click/clack drain in BRONZE with ceramic lid</b> Válvula universal click/clack Bronce con tapa en cerámica Bonde universelle clic/clac Bronze avec clapet en céramique Universal-Ablaufgarnitur Click-Clack Bronze mit Keramikstopfen Универсальный донный клапан click/clack бронза с керамической крышкой</p>	PIL01BR(X)*	0,40	 <b>Gloss White</b>  <b>Le Terre di Cielo</b>  <b>Le Acque di Cielo</b>	<b>135,00</b> <b>182,00</b> <b>182,00</b>
 <p><b>CHROMED siphon</b> Sifone Cromado \ Siphon Chromé \ Siphon Verchromt \ сифон Chrome</p>	SISP	0,93	 <b>Chrome</b>	<b>133,00</b>
 <p><b>MATT BLACK siphon</b> Sifone Negro Mate \ Siphon Noir Mat \ Siphon Schwarz Matt \ Сифон Черный матовый</p>	SIFN	0,93	 <b>Matt Black</b>	<b>194,00</b>
 <p><b>CEMENTO siphon</b> Sifone Cemento \ Siphon Cemento \ Siphon Cemento \ сифон Cemento</p>	SIFCM	0,93	 <b>Cemento</b>	<b>194,00</b>
 <p><b>BRONZE siphon</b> Sifone Bronce \ Siphon Bronze \ Siphon Bronze \ бронза сифон</p>	SIFBR	0,93	 <b>Bronze</b>	<b>220,00</b>
 <p><b>Theo washbasin fixing kit (mandatory)</b> Kit fijación lavabo Theo (obligatorio) Kit de fixation du lavabo Theo (obligatoire) Befestigungsset Waschbecken Theo (obligatorisch) Крепежи для раковины Theo (обязательно)</p>	THKIT	0,30		<b>99,00</b>

**Terre di Cielo available for washbasins** / Terre di Cielo disponibles para el lavabo / Terre di Cielo disponibles pour le lavabo / Für Waschbecken erhältliche Terre di Cielo / Отделка Terre di Cielo доступны для раковины





















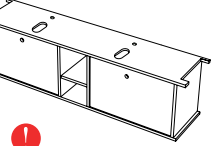







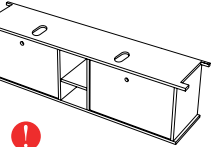





**Acque di Cielo available for washbasins and towel rail** / Acque di Cielo disponibles para el lavabo y toallero / Acque di Cielo disponibles pour le lavabo et porte-serviette / Für Waschbecken und Handtuchhalter erhältliche Acque di Cielo / Отделка Acque di Cielo доступны для раковины и Полотенцедержатель



# Theo 175

with 2 doors and an open compartment / con 2 puertas y un compartimento abierto / avec 2 portes et un compartiment ouvert / mit 2 Schubkästen und einem offenen Fach / Мебельная композиция Theo 175 с 2 дверцами и открытой полкой

# cielo

	<b>Size (cm)</b> Medidas Dimensions Maße Размеры	<b>Product code</b> Artículo Article Artikel Артикул	<b>Net weight (kg)</b> Peso neto Poids net Reingewicht вес нетто	<b>Finishes</b> Acabados Finitions Farbe Отделка	<b>Euro</b> Евро
 <p><b>Round Theo washbasin</b>                      Lavabo Theo ronda \ Lavabo Theo tour \ Aufsatzbecken Runde Theo \ Theo Раковина круглый</p>	ø40 x 16 h	THLAT(X)*	8,50	<ul style="list-style-type: none"> <li> <b>Gloss White</b></li> <li> <b>Le Terre di Cielo</b></li> <li> <b>Le Acque di Cielo</b></li> </ul>	457,00 723,00 723,00
 <p><b>Oval Theo washbasin</b>                      Lavabo Theo oval \ Lavabo Theo ovale \ Aufsatzbecken Oval Theo \ Раковина овальный Theo</p>	55 x 40 x 16 h	THLAO(X)*	10,50	<ul style="list-style-type: none"> <li> <b>Gloss White</b></li> <li> <b>Le Terre di Cielo</b></li> <li> <b>Le Acque di Cielo</b></li> </ul>	688,00 896,00 896,00
 <p><b>Theo 175 cabinet with 2 drawers and an open compartment</b>                      Theo 175 con 2 puertas y un compartimento abierto \ Theo 175 avec 2 portes et un compartiment ouvert \ Theo 175 mit 2 Schubkästen und einem offenen Fach \ Мебельная композиция Theo 175 с 2 дверцами и открытой полкой</p>	175 x 38 x 47h	THMF175C2(X)*	56,00	<ul style="list-style-type: none"> <li> *X = FGR - Grafite</li> <li> *X = FTI - Titanio</li> <li> *X = FJU - Juta</li> <li> *X = FCO - Cotone</li> <li> *X = FCA - Carminio</li> <li> *X = FZO - Zolfo</li> <li> *X = FFE - Felce</li> <li> *X = FCB - Cobalto</li> </ul>	5752,00
 <p><b>Theo 175 cabinet with 2 drawers and an open compartment without tap hole</b>                      Theo 175 con 2 puertas y un compartimento abierto sin agujero grifería \ Theo 175 avec 2 portes et un compartiment ouvert sans trou de robinetterie \ Theo 175 mit 2 Schubkästen und einem offenen Fach ohne Hahnloch \ Мебельная композиция Theo 175 с 2 дверцами и открытой полкой без отверстия под смеситель</p>	175 x 38 x 47h	THMF175C2SF(X)* no tap hole sin agujero sans orifice ohne Loch без отверстия	56,00	<ul style="list-style-type: none"> <li> *X = FGR - Grafite</li> <li> *X = FTI - Titanio</li> <li> *X = FJU - Juta</li> <li> *X = FCO - Cotone</li> <li> *X = FCA - Carminio</li> <li> *X = FZO - Zolfo</li> <li> *X = FFE - Felce</li> <li> *X = FCB - Cobalto</li> </ul>	5752,00
 <p><b>Towel rail</b>                      Toallero \ porte-serviette \ Handtuchhalter \ Полотенцедержатель</p>	31 x ø3	THPL(X)*	0,35	<ul style="list-style-type: none"> <li> *X = NM - Matt Black</li> <li> *X = CM - Cemento</li> <li> <b>Le Acque di Cielo</b></li> </ul>	101,00 104,00 112,00
 <p><b>Metal leg</b>                      Pata en metal \ Pied en métal \ Bein aus Metall \ Ножка металлическая</p>	h24 x 20 x 35	THGA(X)*	1,50	<ul style="list-style-type: none"> <li> *X = NM - Matt Black</li> <li> *X = CM - Cemento</li> <li> <b>Le Acque di Cielo</b></li> </ul>	195,00 201,00 216,00

**The furniture is suitable for both floor and hanging installation. Mandatory composition: basin+ furniture + towel rail + art. THKIT. Legs are for floor furniture only.**  
 El mueble está diseñado para instalación tanto a suelo como suspendido. Composición obligatoria: lavabo + mueble + toallero + art. THKIT. \ Las patas son solo para la versión de mueble a suelo. La composición vasque + meuble + porte-serviettes + art. THKIT est obligatoire. Les pieds sont uniquement pour la version au sol. \ Das Möbel ist in Standversion erhältlich und auch für Wandmontage geeignet. Das Möbel besteht obligatorisch aus: Becken + Möbel + Handtuchhalter + THKIT. Die Beine sind nur für die Standversion vorgesehen \ Мебель возможна в двух версиях: напольная и подвесная. Обязательный комплект: раковина + тумба + полотенцесушитель + THKIT. Ножки только для напольной версии.

### Technical symbols legend

Símbolos técnicos clave / Légende symboles techniques / Technische Zeichenerklärung / Перечень технических символов

 all sides are enamelled  
 con todos los lados esmaltados  
 avec tous les côtés émaillés  
 alle Seiten glasiert  
 все стороны покрыты эмалью

 without overflow  
 sin rebosadero  
 installation à partir du plan  
 Montage auf Platte  
 ohne Überlauf  
 без слива-перелива

























 no tap holes  
 sin agujero para grifo  
 sans orifice robinet  
 ohne Hahnloch  
 без отверстия под смеситель

 on top installation  
 instalación de apoyo  
 installation à partir du plan  
 Montage auf Platte  
 установка на столешницу

# Theo 175

drains and siphons / desagües y sifones / les drains et les siphons / Ablaufgarnituren und Siphons / Донные клапаны и сифоны

# cielo

	Product code Artículo Article Artikel Артикул	Net weight (Kg) Peso neto Poids net Reingewicht вес нетто	Finishes Acabados Finitions Farbe Отделки	Euro Евро
 <p><b>Universal click/clack drain in CHROME with ceramic lid</b> Válvula universal click/clack Cromado con tapa en cerámica Bonde universelle clic/clac Chromé avec clapet en céramique Universal-Ablaufgarnitur Click-Clack Chrom mit Keramikstopfen Универсальный донный клапан click/clack хром с керамической крышкой</p>	PIL01(X)*	0,40	 <b>Gloss White</b>  <b>Le Terre di Cielo</b>  <b>Le Acque di Cielo</b>	<b>95,00</b> <b>139,00</b> <b>139,00</b>
 <p><b>Universal click/clack drain in BLACK MATT finish with ceramic lid</b> Válvula universal click/clack Negro Matt con tapa en cerámica Bonde universelle clic/clac Noir Mat avec clapet en céramique Universal-Ablaufgarnitur Click-Clack Matt Schwarz mit Keramikstopfen Универсальный донный клапан click/clack черный матовый с керамической крышкой</p>	PIL01NM(X)*	0,40	 <b>Gloss White</b>  <b>Le Terre di Cielo</b>  <b>Le Acque di Cielo</b>	<b>120,00</b> <b>169,00</b> <b>169,00</b>
 <p><b>Universal click/clack drain in CEMENTO finish with ceramic lid</b> Válvula universal click/clack Cemento con tapa en cerámica Bonde universelle clic/clac Cemento avec clapet en céramique Universal-Ablaufgarnitur Click-Clack Cement mit Keramikstopfen Универсальный донный Cemento click/clack с керамической крышкой</p>	PIL01CM(X)*	0,40	 <b>Gloss White</b>  <b>Le Terre di Cielo</b>  <b>Le Acque di Cielo</b>	<b>120,00</b> <b>169,00</b> <b>169,00</b>
 <p><b>Universal click/clack drain in BRONZE with ceramic lid</b> Válvula universal click/clack Bronce con tapa en cerámica Bonde universelle clic/clac Bronze avec clapet en céramique Universal-Ablaufgarnitur Click-Clack Bronze mit Keramikstopfen Универсальный донный клапан click/clack бронза с керамической крышкой</p>	PIL01BR(X)*	0,40	 <b>Gloss White</b>  <b>Le Terre di Cielo</b>  <b>Le Acque di Cielo</b>	<b>135,00</b> <b>182,00</b> <b>182,00</b>
 <p><b>CHROMED siphon</b> Sifone Cromado \ Siphon Chromé \ Siphon Verchromt \ сифон Chrome</p>	SISP	0,93	 <b>Chrome</b>	<b>133,00</b>
 <p><b>MATT BLACK siphon</b> Sifone Negro Mate \ Siphon Noir Mat \ Siphon Schwarz Matt \ Сифон Черный матовый</p>	SIFN	0,93	 <b>Matt Black</b>	<b>194,00</b>
 <p><b>CEMENTO siphon</b> Sifone Cemento \ Siphon Cemento \ Siphon Cemento \ сифон Cemento</p>	SIFCM	0,93	 <b>Cemento</b>	<b>194,00</b>
 <p><b>BRONZE siphon</b> Sifone Bronce \ Siphon Bronze \ Siphon Bronze \ бронза сифон</p>	SIFBR	0,93	 <b>Bronze</b>	<b>220,00</b>
 <p><b>Theo washbasin fixing kit (mandatory)</b> Kit fijación lavabo Theo (obligatorio) Kit de fixation du lavabo Theo (obligatoire) Befestigungsset Waschbecken Theo (obligatorisch) Крепежи для раковины Theo (обязательно)</p>	THKIT	0,30		<b>99,00</b>

**Terre di Cielo available for washbasins** / Terre di Cielo disponibles para el lavabo / Terre di Cielo disponibles pour le lavabo / Für Waschbecken erhältliche Terre di Cielo / Отделка Terre di Cielo доступны для раковины

-  TL - Talco
-  PM - Pomice
-  BR - Brina
-  BA - Basalto
-  LV - Lavagna
-  CM - Cemento
-  FN - Fango
-  CA - Cacao
-  AN - Arenaria
-  AV - Avena
-  LN - Lino
-  AG - Agave
-  MU - Muschio
-  PL - Polvere
-  CP - Cipria
-  CN - Canapa





**Acque di Cielo available for washbasins and towel rail** / Acque di Cielo disponibles para el lavabo y toallero / Acque di Cielo disponibles pour le lavabo et porte-serviette / Für Waschbecken und Handtuchhalter erhältliche Acque di Cielo / Отделка Acque di Cielo доступны для раковины и Полотенцедержатель

-  OL - Oltremare
-  SM - Smeraldo
-  AL - Alga
-  CO - Corallo
-  NI - Ninfea
-  AM - Anemone

# Theo

mirrors | espejos | miroirs | Spiegel | зеркала

# cielo

	Size (cm) Medidas Dimensions Maße Размеры	Product code Artículo Article Artikel Артикул	Net weight (kg) Peso neto Poids net Reingewicht вес нетто	Finishes Acabados Finitions Farbe Отделки	Euro Евро
 <p><b>Theo right mirror</b> Espejo Theo Derecho \ Miroir Theo droit \ Spiegel Theo rechts \ Зеркало Theo левостороннее</p>	80 x 13 x 78h	THSPDX(x)*	17,50	<ul style="list-style-type: none"> <li><span style="display: inline-block; width: 10px; height: 10px; background-color: black; border-radius: 50%; margin-right: 5px;"></span> *X = FGR - Grafite</li> <li><span style="display: inline-block; width: 10px; height: 10px; background-color: #444; border-radius: 50%; margin-right: 5px;"></span> *X = FTI - Titanio</li> <li><span style="display: inline-block; width: 10px; height: 10px; background-color: #666; border-radius: 50%; margin-right: 5px;"></span> *X = FJU - Juta</li> <li><span style="display: inline-block; width: 10px; height: 10px; background-color: #888; border-radius: 50%; margin-right: 5px;"></span> *X = FCO - Cotone</li> <li><span style="display: inline-block; width: 10px; height: 10px; background-color: #a00; border-radius: 50%; margin-right: 5px;"></span> *X = FCA - Carminio</li> <li><span style="display: inline-block; width: 10px; height: 10px; background-color: #c00; border-radius: 50%; margin-right: 5px;"></span> *X = FZO - Zolfo</li> <li><span style="display: inline-block; width: 10px; height: 10px; background-color: #008000; border-radius: 50%; margin-right: 5px;"></span> *X = FFE - Felce</li> <li><span style="display: inline-block; width: 10px; height: 10px; background-color: #000080; border-radius: 50%; margin-right: 5px;"></span> *X = FCB - Cobalto</li> </ul>	3073,00
 <p><b>Theo left mirror</b> Espejo Theo izquierdo \ Miroir Theo gauche \ Spiegel Theo links \ Зеркало Theo левостороннее</p>	80 x 13 x 78h	THSPSX(x)*	17,50	<ul style="list-style-type: none"> <li><span style="display: inline-block; width: 10px; height: 10px; background-color: black; border-radius: 50%; margin-right: 5px;"></span> *X = FGR - Grafite</li> <li><span style="display: inline-block; width: 10px; height: 10px; background-color: #444; border-radius: 50%; margin-right: 5px;"></span> *X = FTI - Titanio</li> <li><span style="display: inline-block; width: 10px; height: 10px; background-color: #666; border-radius: 50%; margin-right: 5px;"></span> *X = FJU - Juta</li> <li><span style="display: inline-block; width: 10px; height: 10px; background-color: #888; border-radius: 50%; margin-right: 5px;"></span> *X = FCO - Cotone</li> <li><span style="display: inline-block; width: 10px; height: 10px; background-color: #a00; border-radius: 50%; margin-right: 5px;"></span> *X = FCA - Carminio</li> <li><span style="display: inline-block; width: 10px; height: 10px; background-color: #c00; border-radius: 50%; margin-right: 5px;"></span> *X = FZO - Zolfo</li> <li><span style="display: inline-block; width: 10px; height: 10px; background-color: #008000; border-radius: 50%; margin-right: 5px;"></span> *X = FFE - Felce</li> <li><span style="display: inline-block; width: 10px; height: 10px; background-color: #000080; border-radius: 50%; margin-right: 5px;"></span> *X = FCB - Cobalto</li> </ul>	3073,00
 <p><b>Theo Rectangular mirror</b> Espejo Theo Rectangular \ Miroir Theo rectangulaire \ Spiegel Theo rechteckig \ Зеркало Theo прямоугольное</p>	74 x 12,5 x 100 h	THSPR(x)*	15,00	<ul style="list-style-type: none"> <li><span style="display: inline-block; width: 10px; height: 10px; background-color: black; border-radius: 50%; margin-right: 5px;"></span> *X = FGR - Grafite</li> <li><span style="display: inline-block; width: 10px; height: 10px; background-color: #444; border-radius: 50%; margin-right: 5px;"></span> *X = FTI - Titanio</li> <li><span style="display: inline-block; width: 10px; height: 10px; background-color: #666; border-radius: 50%; margin-right: 5px;"></span> *X = FJU - Juta</li> <li><span style="display: inline-block; width: 10px; height: 10px; background-color: #888; border-radius: 50%; margin-right: 5px;"></span> *X = FCO - Cotone</li> <li><span style="display: inline-block; width: 10px; height: 10px; background-color: #a00; border-radius: 50%; margin-right: 5px;"></span> *X = FCA - Carminio</li> <li><span style="display: inline-block; width: 10px; height: 10px; background-color: #c00; border-radius: 50%; margin-right: 5px;"></span> *X = FZO - Zolfo</li> <li><span style="display: inline-block; width: 10px; height: 10px; background-color: #008000; border-radius: 50%; margin-right: 5px;"></span> *X = FFE - Felce</li> <li><span style="display: inline-block; width: 10px; height: 10px; background-color: #000080; border-radius: 50%; margin-right: 5px;"></span> *X = FCB - Cobalto</li> </ul>	2259,00
 <p><b>Theo 60 mirror</b> Espejo Theo 60 \ Miroir Theo 60 \ Spiegel Theo 60 \ Зеркало Theo 60</p>	ø60 x 3,5	THSPT60(x)*	7,00	<ul style="list-style-type: none"> <li><span style="display: inline-block; width: 10px; height: 10px; background-color: black; border-radius: 50%; margin-right: 5px;"></span> *X = NM - Matt Black</li> <li><span style="display: inline-block; width: 10px; height: 10px; background-color: #444; border-radius: 50%; margin-right: 5px;"></span> *X = CM - Cemento</li> <li><span style="display: inline-block; width: 10px; height: 10px; background-color: #888; border-radius: 50%; margin-right: 5px;"></span> *X = MS - Multistrati</li> </ul>	<p>968,00</p> <p>968,00</p> <p>1085,00</p>
 <p><b>Hook</b> gancho \ Crochet \ Aufhänger \ Крючок</p>		ACGA1(x)*	0,15	<ul style="list-style-type: none"> <li><span style="display: inline-block; width: 10px; height: 10px; background-color: black; border-radius: 50%; margin-right: 5px;"></span> *X = NM - Matt Black</li> <li><span style="display: inline-block; width: 10px; height: 10px; background-color: #444; border-radius: 50%; margin-right: 5px;"></span> *X = CM - Cemento</li> <li><span style="display: inline-block; width: 10px; height: 10px; background-color: #008000; border-radius: 50%; margin-right: 5px;"></span> Le Acque di Cielo</li> </ul>	<p>89,00</p> <p>89,00</p> <p>94,00</p>
<p><b>mandatory combination: mirror + hook</b> combinazione obbligatoria: espejo + gancho combinación obligatoria: miroir + crochet obligatorische Kombination: Spiegel + Aufhänger обязательное сочетание: Зеркало + Крючок</p>					

Acque di Cielo available for hook | Acque di Cielo disponibles para el gancho | Acque di Cielo disponibles pour le Crochet | Für Aufhänger erhältliche Acque di Cielo | Отделки Acque di Cielo доступны для Крючок

OL - Oltremare
  SM - Smeraldo
  AL - Alga
  CO - Corallo
  NI - Ninfea
  AM - Anemone

## Theo Double mirror

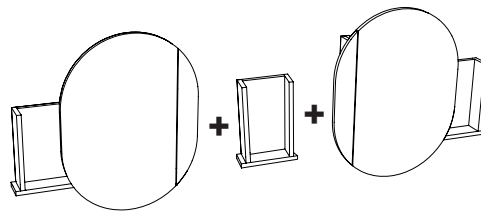

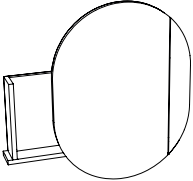
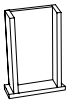
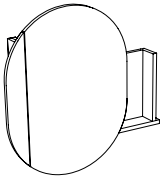
Size (cm)	Product code	Net weight (kg)	Finishes	Euro	
Medidas Dimensions Maße Размеры	Artículo Article Artikel Артикул	Peso neto Poids net Reingewicht вес нетто	Acabados Finitions Farbe Отделки	Евро	
 <p><b>Theo right mirror</b> Espejo Theo Derecho \ Miroir Theo droit \ Spiegel Theo rechts \ Зеркало Theo левостороннее</p>	80 x 13 x 78h	THSPDX(x)*	17,50	<ul style="list-style-type: none"> <li><span style="display: inline-block; width: 10px; height: 10px; background-color: black; border-radius: 50%;"></span> *X = FGR - Grafite</li> <li><span style="display: inline-block; width: 10px; height: 10px; background-color: #666; border-radius: 50%;"></span> *X = FTI - Titanio</li> <li><span style="display: inline-block; width: 10px; height: 10px; background-color: #999; border-radius: 50%;"></span> *X = FJU - Juta</li> <li><span style="display: inline-block; width: 10px; height: 10px; background-color: #ccc; border-radius: 50%;"></span> *X = FCO - Cotone</li> <li><span style="display: inline-block; width: 10px; height: 10px; background-color: #800; border-radius: 50%;"></span> *X = FCA - Carminio</li> <li><span style="display: inline-block; width: 10px; height: 10px; background-color: #e69; border-radius: 50%;"></span> *X = FZO - Zolfo</li> <li><span style="display: inline-block; width: 10px; height: 10px; background-color: #388; border-radius: 50%;"></span> *X = FFE - Felce</li> <li><span style="display: inline-block; width: 10px; height: 10px; background-color: #336; border-radius: 50%;"></span> *X = FCB - Cobalto</li> </ul>	3073,00
 <p><b>Central element</b> Elemento central \ Élément central \ Zentrales Element \ Элемент центральный</p>	25 x 10 x 35h	THSPCC(x)*	1,50	<ul style="list-style-type: none"> <li><span style="display: inline-block; width: 10px; height: 10px; background-color: black; border-radius: 50%;"></span> *X = FGR - Grafite</li> <li><span style="display: inline-block; width: 10px; height: 10px; background-color: #666; border-radius: 50%;"></span> *X = FTI - Titanio</li> <li><span style="display: inline-block; width: 10px; height: 10px; background-color: #999; border-radius: 50%;"></span> *X = FJU - Juta</li> <li><span style="display: inline-block; width: 10px; height: 10px; background-color: #ccc; border-radius: 50%;"></span> *X = FCO - Cotone</li> <li><span style="display: inline-block; width: 10px; height: 10px; background-color: #800; border-radius: 50%;"></span> *X = FCA - Carminio</li> <li><span style="display: inline-block; width: 10px; height: 10px; background-color: #e69; border-radius: 50%;"></span> *X = FZO - Zolfo</li> <li><span style="display: inline-block; width: 10px; height: 10px; background-color: #388; border-radius: 50%;"></span> *X = FFE - Felce</li> <li><span style="display: inline-block; width: 10px; height: 10px; background-color: #336; border-radius: 50%;"></span> *X = FCB - Cobalto</li> </ul>	898,00
 <p><b>Theo left mirror</b> Espejo Theo izquierdo \ Miroir Theo gauche \ Spiegel Theo links \ Зеркало Theo левостороннее</p>	80 x 13 x 78h	THSPSX(x)*	17,50	<ul style="list-style-type: none"> <li><span style="display: inline-block; width: 10px; height: 10px; background-color: black; border-radius: 50%;"></span> *X = FGR - Grafite</li> <li><span style="display: inline-block; width: 10px; height: 10px; background-color: #666; border-radius: 50%;"></span> *X = FTI - Titanio</li> <li><span style="display: inline-block; width: 10px; height: 10px; background-color: #999; border-radius: 50%;"></span> *X = FJU - Juta</li> <li><span style="display: inline-block; width: 10px; height: 10px; background-color: #ccc; border-radius: 50%;"></span> *X = FCO - Cotone</li> <li><span style="display: inline-block; width: 10px; height: 10px; background-color: #800; border-radius: 50%;"></span> *X = FCA - Carminio</li> <li><span style="display: inline-block; width: 10px; height: 10px; background-color: #e69; border-radius: 50%;"></span> *X = FZO - Zolfo</li> <li><span style="display: inline-block; width: 10px; height: 10px; background-color: #388; border-radius: 50%;"></span> *X = FFE - Felce</li> <li><span style="display: inline-block; width: 10px; height: 10px; background-color: #336; border-radius: 50%;"></span> *X = FCB - Cobalto</li> </ul>	3073,00



**mandatory composition: Theo right mirror + central element + Theo left mirror.**

Composición obligatoria: espejo Theo Derecho + elemento central + espejo Theo izquierdo \ Composition obligatoire: Miroir Theo droit + Élément central + Miroir Theo gauche \ Obligatorische Kombination: Spiegel Theo rechts + Zentrales Element + Spiegel Theo links \ Зеркало Theo левостороннее + Элемент центральный + Зеркало Theo левостороннее

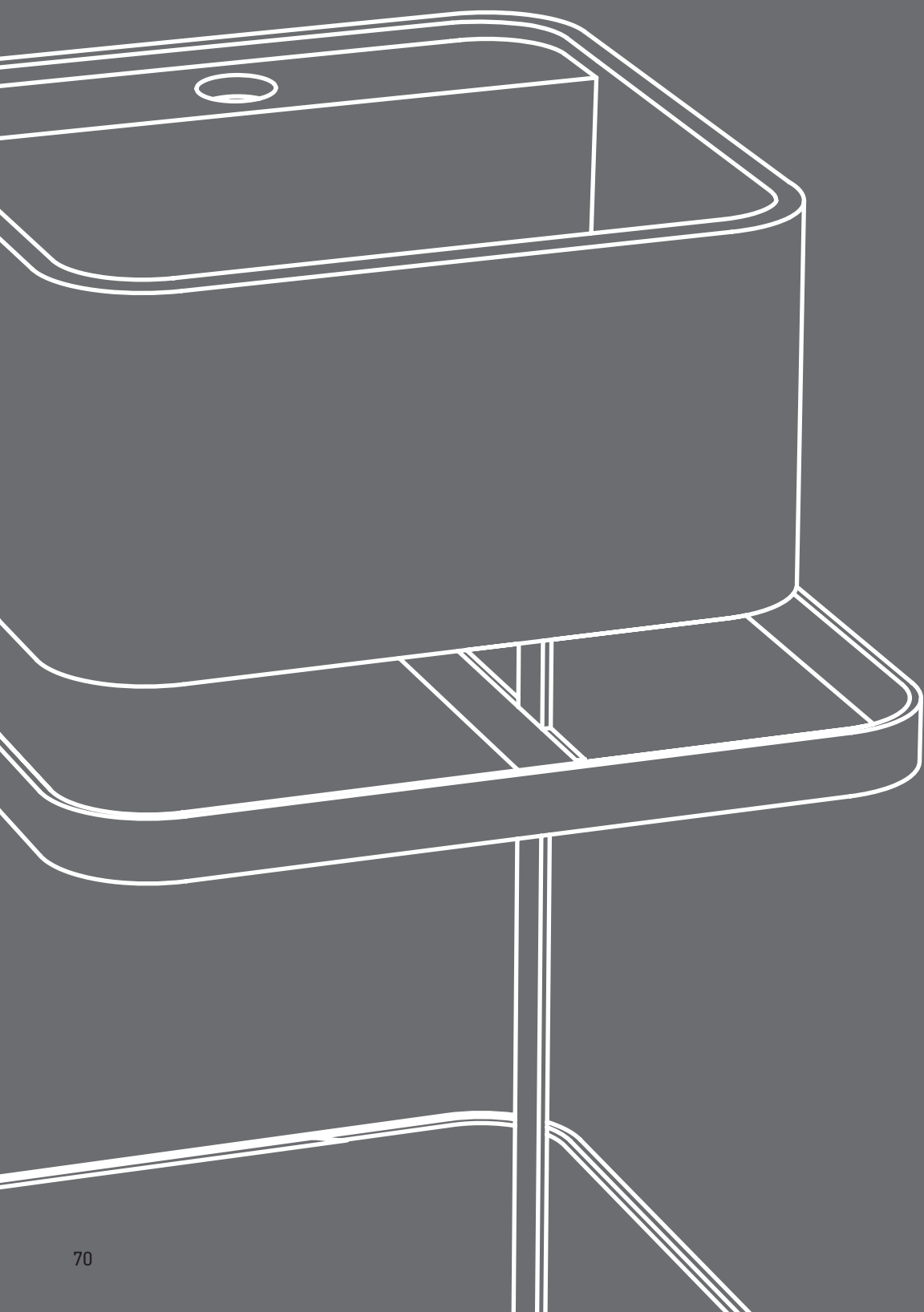



# Les Petites

design **Andrea Parisio & Giuseppe Pezzano**

QR code configuratore \ configurator pg. 75

indice collezione \ collection index pg. 77

moduli d'ordine \ order form pg. 79 - 89

listino prezzi \ price list pg. 91 - 99









## Configure the product directly online and send the order to Cielo.

Configure el producto directamente online y envíe el pedido a Cielo.

Configurez le produit directement en ligne et envoyez la commande à Cielo.

Konfigurieren Sie Ihr Produkt online und schicken Sie die Bestellung direkt an Cielo.

Сконфигурируйте изделие в онлайн и перешлите заказ на фабрику Cielo.

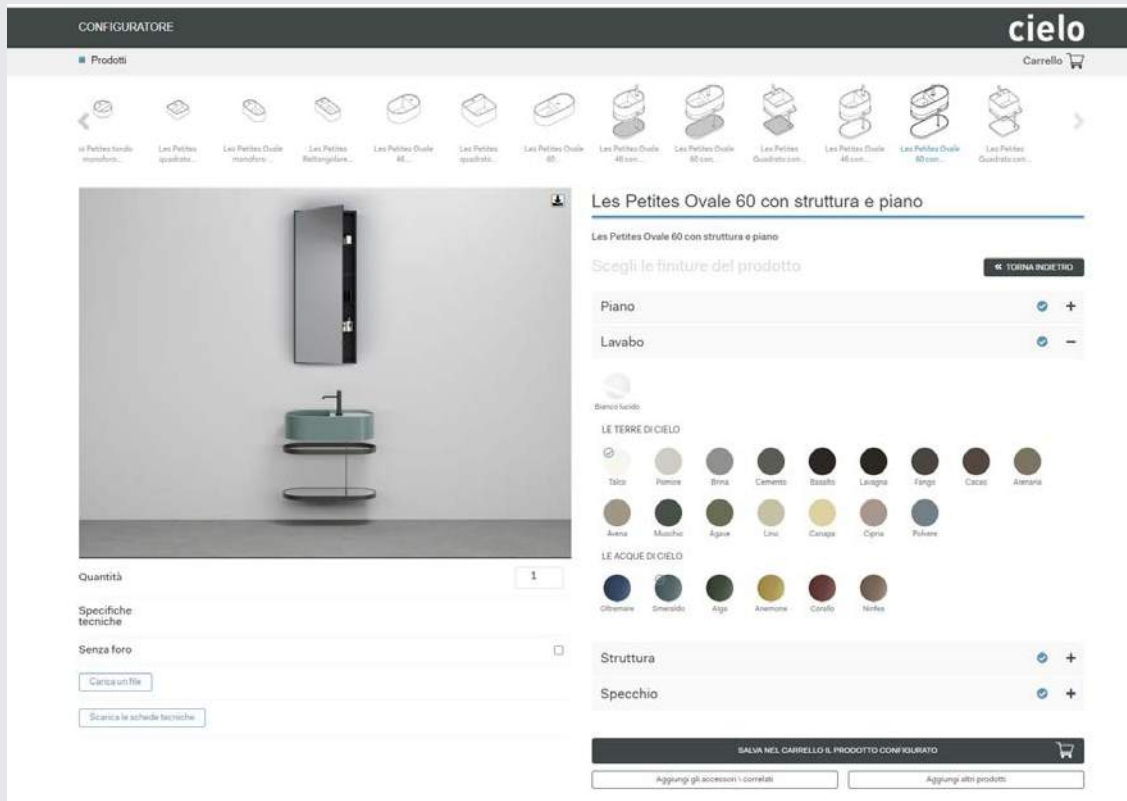

EN



go to the  
configurator

SP

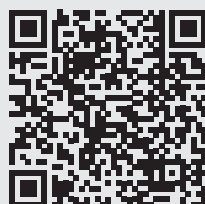

ir al  
configurador

FR



lien vers le  
configurateur

RU



Перейдите в  
конфигуратор

## Available finish for washbasin and top

Acabado lavabo y encimera / Finitions lavabo et plaque / Ausführung Waschbecken und Platte / Отделка раковины и пластин

 Glossy White

### Le Terre di Cielo

- |   |   |
|---|---|
|  TL - Talco   |  AN - Arenaria |
|  PM - Pomice  |  AV - Avena    |
|  BR - Brina   |  MU - Muschio  |
|  CM - Cemento |  AG - Agave    |
|  BA - Basalto |  LN - Lino     |
|  LV - Lavagna |  CN - Canapa   |
|  FN - Fango   |  CP - Cipria   |
|  CA - Cacao   |  PL - Polvere  |

### Le Acque di Cielo

-  OL - Oltremare
-  SM - Smeraldo
-  AL - Alga
-  CO - Corallo
-  NI - Ninfea
-  AM - Anemone

## Structure finishes

Estructura \ Structure \ Gestell \ Структура

 NM - Nero Matt

 CM - Cemento

### Le Acque di Cielo

 OL - Oltremare

 SM - Smeraldo

 AL - Alga

 CO - Corallo

 NI - Ninfea

 AM - Anemone

## Lavabi / washbasins

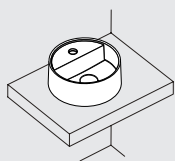

**LPLAT**  
 ø28 x 11,5 h  
 pag. 91

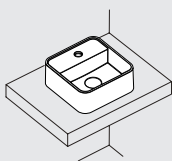

**LPLAQ**  
 28 x 28 x 11,5 h  
 pag. 91

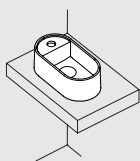

**LPLAO**  
 33,5 x 18,5 x 11,5 h  
 pag. 91

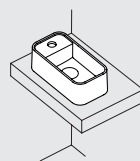

**LPLAR**  
 33,5 x 18,5 x 11,5 h  
 pag. 91

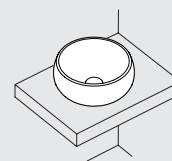

**BAT030**  
 30 x 30 x 14,5 h  
 pag. 92

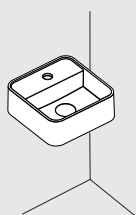

**installazione sospesa**  
 wall-hung installation

**LPLAQ35**  
 35 x 35 x 16 h  
 pag. 92

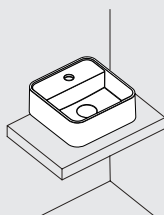

**installazione da piano**  
 on top installation

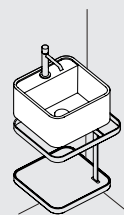

**Les Petites Quadrato 35 con struttura**  
 Les Petites Quadrato 35 with framework  
 pag. 94

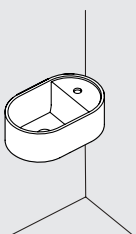

**installazione sospesa**  
 wall-hung installation

**LPLA046**  
 46 x 30 x 16 h  
 pag. 92

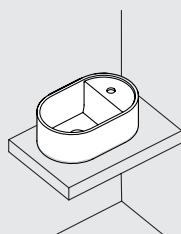

**installazione da piano**  
 on top installation

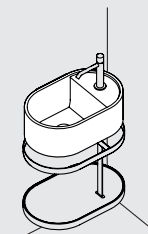

**Les Petites Ovale 46 con struttura**  
 Les Petites Ovale 46 with framework  
 pag. 96

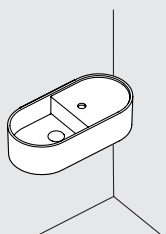

**installazione sospesa**  
 wall-hung installation

**LPLA060**  
 60 x 30 x 16 h  
 pag. 92

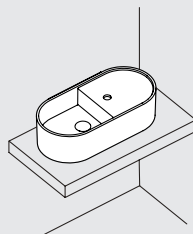

**installazione da piano**  
 on top installation

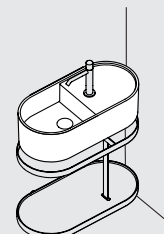

**Les Petites Ovale 60 con struttura**  
 Les Petites Ovale 60 with framework  
 pag. 98



# Les Petites 35



modelli disponibili / available models

## LES PETITES collection

**Les Petites quadrato con  
rete metallica**  
Les Petites square with  
wire mesh  
41 x 35 x 56 h

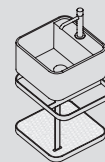

finiture / finishes

### LAVABO IN CERAMICA / CERAMIC WASHBASIN

Bianco Lucido  
Gloss White

Talco Pomice Brina Basalto Lavagna Cemento Fango Cacao Arenaria Avena Lino Agave Muschio Polvere Cipria Canapa

#### Le Terre di Cielo



LPLAQ35

#### Le Acque di Cielo

Oltremare Smeraldo Alga Corallo Ninfea Anemone



LPLAQ35SF

### STRUTTURA E RETE METALLICA IN ACCIAIO / STEEL FRAMEWORK AND WIRE MESH

Nero Matt  
Matt Black

Cemento

#### verniciature / coatings

#### Le Acque di Cielo

Oltremare Smeraldo Alga Corallo Ninfea Anemone

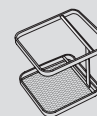

LPSTQR35

note tecniche lavabo / washbasin technical notes

- **monoforo**  
one tap hole
- **senza foro su richiesta**  
no tap hole on requeste
- ☒  
**senza troppopieno**  
without overflow
- ▭  
**installazione da piano**  
on top installation
- ┌  
**installazione sospesa**  
wall-hung installation
- ▭  
**con un lato non smaltato**  
one side is unglazed
- ⌚  
**composizione obbligatoria:**  
**lavabo + struttura**  
mandatory composition:  
washbasin + framework

# Modulo Ordine Les Petites Quadrato con rete metallica

## Les Petites Quadrato with wire mesh Order Form

# cielo

CLIENTE/client:  ORD. REF.:

QUANTITA'/quantity:  EMAIL:

**INDICARE CON UN SEGNO LE FINITURE SCELTE PER I DIVERSI COMPONENTI**

*INDICATE WITH A TICK, THE CHOOSEN FINISHES FOR ALL THE COMPONENTS*

art. **LPLAQ35 / LPLAQ35SF**

### FINITURE LAVABO

WASHBASIN FINISHES

Bianco/white - glossy

Le Terre di Cielo

- |                                    |                                     |
|------------------------------------|-------------------------------------|
| <input type="radio"/> TL - Talco   | <input type="radio"/> AN - Arenaria |
| <input type="radio"/> PM - Pomice  | <input type="radio"/> AV - Avena    |
| <input type="radio"/> BR - Brina   | <input type="radio"/> LN - Lino     |
| <input type="radio"/> BA - Basalto | <input type="radio"/> AG - Agave    |
| <input type="radio"/> LV - Lavagna | <input type="radio"/> MU - Muschio  |
| <input type="radio"/> CM - Cemento | <input type="radio"/> PL - Polvere  |
| <input type="radio"/> FN - Fango   | <input type="radio"/> CP - Cipria   |
| <input type="radio"/> CA - Cacao   | <input type="radio"/> CN - Canapa   |

Le Acque di Cielo

- OL - Oltremare
- SM - Smeraldo
- AL - Alga
- CO - Corallo
- NI - Ninfea
- AM - Anemone

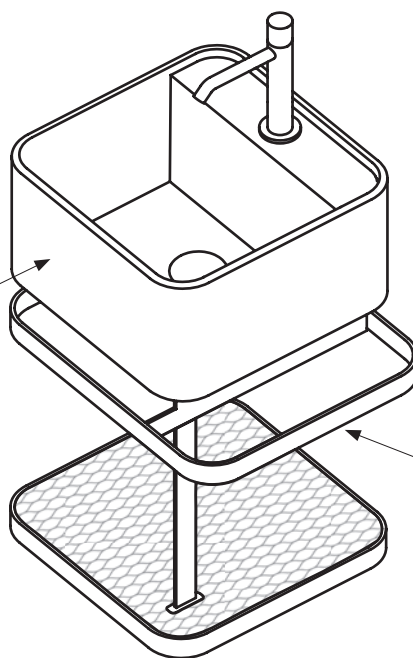

art. **LPSTQR35**

### FINITURE STRUTTURA E RETE METALLICA

FRAMEWORK AND WIRE MESH FINISHES

verniciature\_coatings

- NM - Nero Matt
  - CM - Cemento
- Le Acque di Cielo
- OL - Oltremare
  - SM - Smeraldo
  - AL - Alga
  - CO - Corallo
  - NI - Ninfea
  - AM - Anemone

**DATA**

DATE

**FIRMA DEL CLIENTE**

SIGNATURE

**ATTENZIONE:**  
La rappresentazione delle finiture è puramente indicativa. Verificare le finiture con le relative cartelle.

Ogni oggetto possiede la peculiarità di essere elaborato secondo principi puramente tradizionali, in modo da garantirne l'assoluta originalità ed unicità. Le eventuali piccole variazioni di colore, tono o venature fra gli articoli sono da considerarsi pregi e non difetti, in quanto garanzia della fattura manuale del prodotto, che fa di ogni oggetto Cielo un pezzo unico ed esclusivo, lontano dall'omologazione industriale. In fase d'ordine si intendono, pertanto, accettate tali tolleranze che non possono dare adito a contestazioni di alcun genere.

Verificare sempre le disponibilità e i tempi di consegna con il commerciale.

**ATTENTION:**  
The representation of the finishes is merely indicative. Please choose the finishes using the folders.

Every item possesses that particular feature of being processed according to purely traditional principles that guarantee its absolute originality and uniqueness. The small variations in colour, hues or streaks on the items are to be considered as qualities and not defects, since they warranty the handcrafted processing which makes each Cielo item a unique and exclusive piece that cannot be compared to industrial standardization. When making the order, the client implicitly accepts those various features that may give rise to claims of any sort.

Always check the availability and delivery time with the commercial department.

# Les Petites 35

modelli disponibili / available models

## LES PETITES

collection

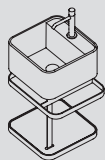

**Les Petites quadrato con piano in ceramica**  
Les Petites square with ceramic shelf  
41 x 35 x 56 h



finiture / finishes



LPLAQ35

### LAVABO IN CERAMICA / CERAMIC WASHBASIN

#### Le Terre di Cielo

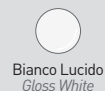
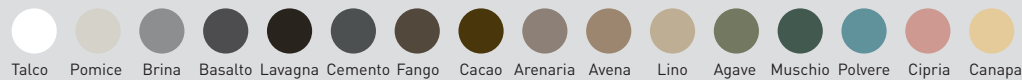

LPLAQ35SF

#### Le Acque di Cielo



LPSTQ35

### STRUTTURA IN ACCIAIO / STEEL FRAMEWORK

#### verniciature / coatings

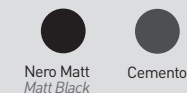

#### Le Acque di Cielo



### PIANO IN CERAMICA / CERAMIC SHELF



LPPIQ35

#### Le Terre di Cielo

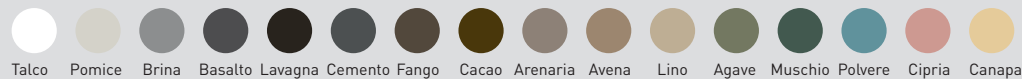

#### Le Acque di Cielo



note tecniche lavabo / washbasin technical notes

monoforo  
one tap hole

senza foro su richiesta  
no tap hole on request

senza troppopieno  
without overflow

installazione da piano  
on top installation

installazione sospesa  
wall-hung installation

con un lato non smaltato  
one side is unglazed

composizione obbligatoria:  
lavabo + struttura + piano  
mandatory composition:  
washbasin + framework +  
shelf

# Modulo Ordine Les Petites Quadrato con piano in ceramica

## Les Petites Quadrato with ceramic shelf Order Form

# cielo

CLIENTE/client:  ORD. REF.:

QUANTITÀ/quantity:  EMAIL:

**INDICARE CON UN SEGNO LE FINITURE SCELTE PER I DIVERSI COMPONENTI**

*INDICATE WITH A TICK, THE CHOOSEN FINISHES FOR ALL THE COMPONENTS*

art. **LPSTQ35**

### FINITURE STRUTTURA

FRAMEWORK FINISHES

verniciature\_coatings

● **NM - Nero Matt**

● **CM - Cemento**

Le Acque di Cielo

● **OL - Oltremare** ● **CO - Corallo**

● **SM - Smeraldo** ● **NI - Ninfea**

● **AL - Alga** ● **AM - Anemone**

art. **LPPIQ35**

### FINITURE PIANO

SHELF FINISHES

○ Bianco/white - glossy

Le Terre di Cielo

○ **TL - Talco** ● **AN - Arenaria**

○ **PM - Pomice** ● **AV - Avena**

○ **BR - Brina** ● **LN - Lino**

○ **BA - Basalto** ● **AG - Agave**

○ **LV - Lavagna** ● **MU - Muschio**

○ **CM - Cemento** ● **PL - Polvere**

○ **FN - Fango** ● **CP - Cipria**

○ **CA - Cacao** ● **CN - Canapa**

Le Acque di Cielo

● **OL - Oltremare**

● **SM - Smeraldo**

● **AL - Alga**

● **CO - Corallo**

● **NI - Ninfea**

● **AM - Anemone**

art. **LPLAQ35 / LPLAQ35SF**

### FINITURE LAVABO

WASHBASIN FINISHES

○ Bianco/white - glossy

Le Terre di Cielo

○ **TL - Talco** ● **AN - Arenaria**

○ **PM - Pomice** ● **AV - Avena**

○ **BR - Brina** ● **LN - Lino**

○ **BA - Basalto** ● **AG - Agave**

○ **LV - Lavagna** ● **MU - Muschio**

○ **CM - Cemento** ● **PL - Polvere**

○ **FN - Fango** ● **CP - Cipria**

○ **CA - Cacao** ● **CN - Canapa**

Le Acque di Cielo

● **OL - Oltremare**

● **SM - Smeraldo**

● **AL - Alga**

● **CO - Corallo**

● **NI - Ninfea**

● **AM - Anemone**

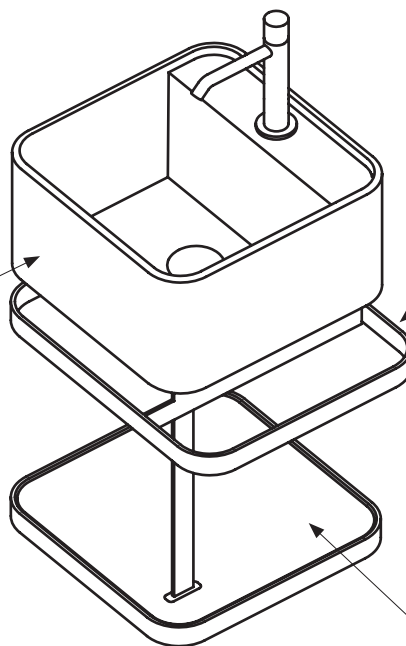

**DATA**  
DATE

**FIRMA DEL CLIENTE**  
SIGNATURE

**ATTENZIONE:**  
La rappresentazione delle finiture è puramente indicativa. Verificare le finiture con le relative cartelle.

Ogni oggetto possiede la peculiarità di essere elaborato secondo principi puramente tradizionali, in modo da garantirne l'assoluta originalità ed unicità. Le eventuali piccole variazioni di colore, tono o venature fra gli articoli sono da considerarsi pregi e non difetti, in quanto garanzia della fattura manuale del prodotto, che fa di ogni oggetto Cielo un pezzo unico ed esclusivo, lontano dall'omologazione industriale. In fase d'ordine si intendono, pertanto, accettate tali tolleranze che non possono dare adito a contestazioni di alcun genere.

Verificare sempre le disponibilità e i tempi di consegna con il commerciale.

**ATTENTION:**  
The representation of the finishes is merely indicative. Please choose the finishes using the folders.

Every item possesses that particular feature of being processed according to purely traditional principles that guarantee its absolute originality and uniqueness. The small variations in colour, hues or streaks on the items are to be considered as qualities and not defects, since they warranty the handcrafted processing which makes each Cielo item a unique and exclusive piece that cannot be compared to industrial standardization. When making the order, the client implicitly accepts those various features that may give rise to claims of any sort.

Always check the availability and delivery time with the commercial department.

# Les Petites 46



modelli disponibili / available models

## LES PETITES collection

**Les Petites ovale 46 con rete metallica**  
Les Petites oval 46 with wire mesh  
46 x 30 x 56 h



finiture / finishes

### LAVABO IN CERAMICA / CERAMIC WASHBASIN

Bianco Lucido  
Gloss White



#### Le Terre di Cielo

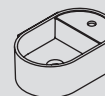

LPLA046

#### Le Acque di Cielo



LPLA046SF

### STRUTTURA E RETE METALLICA IN ACCIAIO / STEEL FRAMEWORK AND WIRE MESH



Nero Matt  
Matt Black

Cemento

#### verniciature / coatings

#### Le Acque di Cielo



Oltremare

Smeraldo

Alga

Corallo

Ninfea

Anemone



LPSTOR46

note tecniche lavabo / washbasin technical notes



**monoforo**  
one tap hole



**senza foro su richiesta**  
no tap hole on request



**senza troppopieno**  
without overflow



**installazione da piano**  
on top installation



**installazione sospesa**  
wall-hung installation



**con un lato non smaltato**  
one side is unglazed



**composizione obbligatoria:**  
**lavabo + struttura**  
mandatory composition:  
washbasin + framework

# Modulo Ordine Les Petites Ovale 46 con rete metallica

## Les Petites Ovale 46 with wire mesh Order Form

# cielo

CLIENTE/client:  ORD. REF.:

QUANTITA'/quantity:  EMAIL:

**INDICARE CON UN SEGNO LE FINITURE SCELTE PER I DIVERSI COMPONENTI**

*INDICATE WITH A TICK, THE CHOOSEN FINISHES FOR ALL THE COMPONENTS*

art. **LPLA046 / LPLA046SF**

### FINITURE LAVABO

WASHBASIN FINISHES

Bianco/white - glossy

Le Terre di Cielo

- |                                    |                                     |
|------------------------------------|-------------------------------------|
| <input type="radio"/> TL - Talco   | <input type="radio"/> AN - Arenaria |
| <input type="radio"/> PM - Pomice  | <input type="radio"/> AV - Avena    |
| <input type="radio"/> BR - Brina   | <input type="radio"/> LN - Lino     |
| <input type="radio"/> BA - Basalto | <input type="radio"/> AG - Agave    |
| <input type="radio"/> LV - Lavagna | <input type="radio"/> MU - Muschio  |
| <input type="radio"/> CM - Cemento | <input type="radio"/> PL - Polvere  |
| <input type="radio"/> FN - Fango   | <input type="radio"/> CP - Cipria   |
| <input type="radio"/> CA - Cacao   | <input type="radio"/> CN - Canapa   |

Le Acque di Cielo

- |                                      |
|--------------------------------------|
| <input type="radio"/> OL - Oltremare |
| <input type="radio"/> SM - Smeraldo  |
| <input type="radio"/> AL - Alga      |
| <input type="radio"/> CO - Corallo   |
| <input type="radio"/> NI - Ninfea    |
| <input type="radio"/> AM - Anemone   |

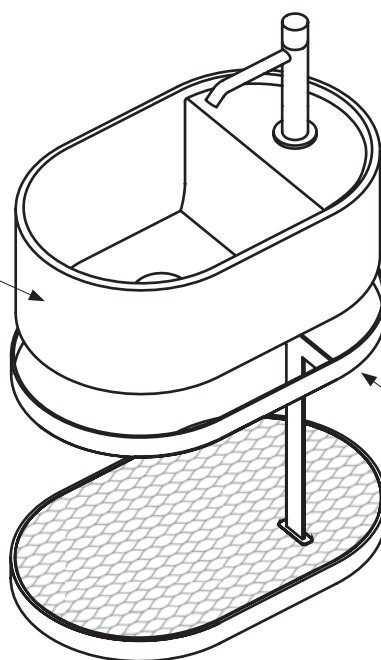

art. **LPST0R46**

### FINITURE STRUTTURA E RETE METALLICA

FRAMEWORK AND WIRE MESH FINISHES

verniciature\_coatings

- |                                      |                                     |
|--------------------------------------|-------------------------------------|
| <input type="radio"/> NM - Nero Matt | <input type="radio"/> CO - Corallo  |
| <input type="radio"/> CM - Cemento   | <input type="radio"/> NI - Ninfea   |
| Le Acque di Cielo                    |                                     |
| <input type="radio"/> OL - Oltremare | <input type="radio"/> SM - Smeraldo |
| <input type="radio"/> AL - Alga      | <input type="radio"/> AM - Anemone  |

**DATA**

DATE

**FIRMA DEL CLIENTE**

SIGNATURE

ATTENZIONE:

La rappresentazione delle finiture è puramente indicativa. Verificare le finiture con le relative cartelle.

Ogni oggetto possiede la peculiarità di essere elaborato secondo principi puramente tradizionali, in modo da garantirne l'assoluta originalità ed unicità. Le eventuali piccole variazioni di colore, tono o venature fra gli articoli sono da considerarsi pregi e non difetti, in quanto garanzia della fattura manuale del prodotto, che fa di ogni oggetto Cielo un pezzo unico ed esclusivo, lontano dall'omologazione industriale. In fase d'ordine si intendono, pertanto, accettate tali tolleranze che non possono dare adito a contestazioni di alcun genere.

Verificare sempre le disponibilità e i tempi di consegna con il commerciale.

ATTENTION:

The representation of the finishes is merely indicative. Please choose the finishes using the folders.

Every item possesses that particular feature of being processed according to purely traditional principles that guarantee its absolute originality and uniqueness. The small variations in colour, hues or streaks on the items are to be considered as qualities and not defects, since they warranty the handcrafted processing which makes each Cielo item a unique and exclusive piece that cannot be compared to industrial standardization. When making the order, the client implicitly accepts those various features that may give rise to claims of any sort.

Always check the availability and delivery time with the commercial department.

**modelli disponibili / available models**

## LES PETITES

collection

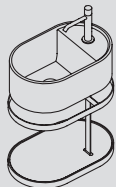

**Les Petites ovale 46 con piano in ceramica**  
Les Petites oval 46 with ceramic shelf  
46 x 30 x 56 h



**finiture / finishes**

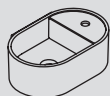

**LAVABO IN CERAMICA / CERAMIC WASHBASIN**

**Le Terre di Cielo**



LPLA046



**Le Acque di Cielo**



LPLA046SF

**STRUTTURA IN ACCIAIO / STEEL FRAMEWORK**

**verniciature / coatings**

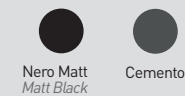

LPST046

**Le Acque di Cielo**



**PIANO IN CERAMICA / CERAMIC SHELF**

**Le Terre di Cielo**

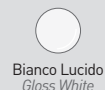
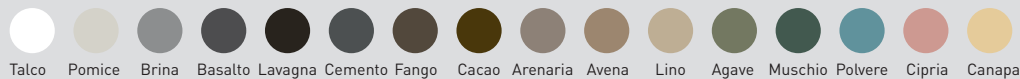

LPPI046

**Le Acque di Cielo**



**note tecniche lavabo / washbasin technical notes**

**monoforo**  
one tap hole

**senza foro su richiesta**  
no tap hole on request

**senza troppopieno**  
without overflow

**installazione da piano**  
on top installation

**installazione sospesa**  
wall-hung installation

**con un lato non smaltato**  
one side is unglazed

**composizione obbligatoria:**  
lavabo + struttura + piano  
mandatory composition:  
washbasin + framework + shelf



# Modulo Ordine Les Petites Ovale 46 con piano in ceramica

## Les Petites Ovale 46 with ceramic shelf Order Form

# cielo

CLIENTE/client:  ORD. REF.:

QUANTITÀ/quantity:  EMAIL:

**INDICARE CON UN SEGNO LE FINITURE SCELTE PER I DIVERSI COMPONENTI**

**INDICATE WITH A TICK, THE CHOOSEN FINISHES FOR ALL THE COMPONENTS**

art. **LPLA046 / LPLA046SF**

### FINITURE LAVABO

WASHBASIN FINISHES

Bianco/white - glossy

Le Terre di Cielo

- |                                    |                                     |
|------------------------------------|-------------------------------------|
| <input type="radio"/> TL - Talco   | <input type="radio"/> AN - Arenaria |
| <input type="radio"/> PM - Pomice  | <input type="radio"/> AV - Avena    |
| <input type="radio"/> BR - Brina   | <input type="radio"/> LN - Lino     |
| <input type="radio"/> BA - Basalto | <input type="radio"/> AG - Agave    |
| <input type="radio"/> LV - Lavagna | <input type="radio"/> MU - Muschio  |
| <input type="radio"/> CM - Cemento | <input type="radio"/> PL - Polvere  |
| <input type="radio"/> FN - Fango   | <input type="radio"/> CP - Cipria   |
| <input type="radio"/> CA - Cacao   | <input type="radio"/> CN - Canapa   |

Le Acque di Cielo

- OL - Oltremare
- SM - Smeraldo
- AL - Alga
- CO - Corallo
- NI - Ninfea
- AM - Anemone

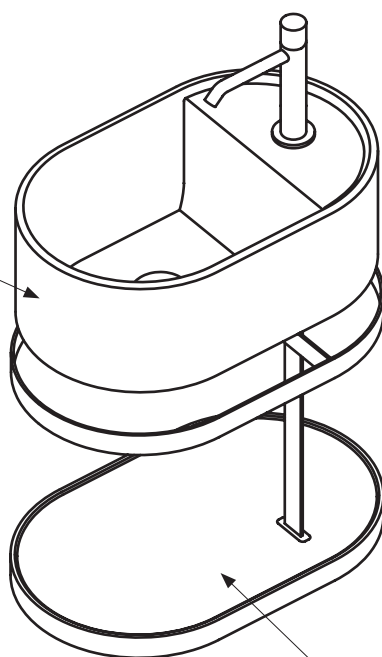

art. **LPST046**

### FINITURE STRUTTURA

FRAMEWORK FINISHES

verniciature\_coatings

NM - Nero Matt

CM - Cemento

Le Acque di Cielo

- |                                      |                                    |
|--------------------------------------|------------------------------------|
| <input type="radio"/> OL - Oltremare | <input type="radio"/> CO - Corallo |
| <input type="radio"/> SM - Smeraldo  | <input type="radio"/> NI - Ninfea  |
| <input type="radio"/> AL - Alga      | <input type="radio"/> AM - Anemone |

art. **LPPI046**

### FINITURE PIANO

SHELF FINISHES

Bianco/white - glossy

Le Terre di Cielo

- |                                    |                                     |
|------------------------------------|-------------------------------------|
| <input type="radio"/> TL - Talco   | <input type="radio"/> AN - Arenaria |
| <input type="radio"/> PM - Pomice  | <input type="radio"/> AV - Avena    |
| <input type="radio"/> BR - Brina   | <input type="radio"/> LN - Lino     |
| <input type="radio"/> BA - Basalto | <input type="radio"/> AG - Agave    |
| <input type="radio"/> LV - Lavagna | <input type="radio"/> MU - Muschio  |
| <input type="radio"/> CM - Cemento | <input type="radio"/> PL - Polvere  |
| <input type="radio"/> FN - Fango   | <input type="radio"/> CP - Cipria   |
| <input type="radio"/> CA - Cacao   | <input type="radio"/> CN - Canapa   |

Le Acque di Cielo

- OL - Oltremare
- SM - Smeraldo
- AL - Alga
- CO - Corallo
- NI - Ninfea
- AM - Anemone

**DATA**  
DATE

**FIRMA DEL CLIENTE**  
SIGNATURE

**ATTENZIONE:**  
La rappresentazione delle finiture è puramente indicativa. Verificare le finiture con le relative cartelle.

Ogni oggetto possiede la peculiarità di essere elaborato secondo principi puramente tradizionali, in modo da garantirne l'assoluta originalità ed unicità. Le eventuali piccole variazioni di colore, tono o venature fra gli articoli sono da considerarsi pregi e non difetti, in quanto garanzia della fattura manuale del prodotto, che fa di ogni oggetto Cielo un pezzo unico ed esclusivo, lontano dall'omologazione industriale. In fase d'ordine si intendono, pertanto, accettate tali tolleranze che non possono dare adito a contestazioni di alcun genere.

Verificare sempre le disponibilità e i tempi di consegna con il commerciale.

**ATTENTION:**  
The representation of the finishes is merely indicative. Please choose the finishes using the folders.

Every item possesses that particular feature of being processed according to purely traditional principles that guarantee its absolute originality and uniqueness. The small variations in colour, hues or streaks on the items are to be considered as qualities and not defects, since they warranty the handcrafted processing which makes each Cielo item a unique and exclusive piece that cannot be compared to industrial standardization. When making the order, the client implicitly accepts those various features that may give rise to claims of any sort.

Always check the availability and delivery time with the commercial department.

# Les Petites 60



**Les Petites ovale 60**  
finitura lavabo / washbasin  
finish **Talco**, finitura  
struttura / framework  
finish **Nero Matt**  
/ **Matt Black**

modelli disponibili / available models

## LES PETITES collection

**Les Petites ovale 60 con  
rete metallica**  
Les Petites oval 60 with  
wire mesh  
60 x 3 x 56 h

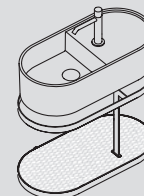

finiture / finishes

### LAVABO IN CERAMICA / CERAMIC WASHBASIN

Bianco Lucido  
Gloss White



Talco



Pomice



Brina



Basalto



Lavagna



Cemento



Fango



Cacao



Arenaria



Avena



Lino



Agave



Muschio



Polvere



Cipria



Canapa

### Le Terre di Cielo

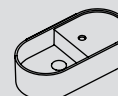

LPLA060

### Le Acque di Cielo



Oltremare



Smeraldo



Alga



Corallo



Ninfea



Anemone

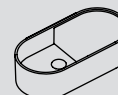

LPLA060SF

### STRUTTURA E RETE METALLICA IN ACCIAIO / STEEL FRAMEWORK AND WIRE MESH



Nero Matt  
Matt Black



Cemento



Oltremare



Smeraldo



Alga



Corallo



Ninfea



Anemone

### verniciature / coatings

### Le Acque di Cielo

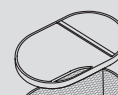

LPSTOR46

note tecniche lavabo / washbasin technical notes



**monoforo**  
one tap hole



**senza foro su richiesta**  
no tap hole on request



**senza troppopieno**  
without overflow



**installazione da piano**  
on top installation



**installazione sospesa**  
wall-hung installation



**con un lato non smaltato**  
one side is unglazed



**composizione obbligatoria:**  
lavabo + struttura  
mandatory composition:  
washbasin + framework

# Modulo Ordine Les Petites Ovale 60 con rete metallica

## Les Petites Ovale 60 with wire mesh Order Form

# cielo

CLIENTE/client:  ORD. REF.:

QUANTITA'/quantity:  EMAIL:

**INDICARE CON UN SEGNO LE FINITURE SCELTE PER I DIVERSI COMPONENTI**

*INDICATE WITH A TICK, THE CHOOSEN FINISHES FOR ALL THE COMPONENTS*

art. **LPLA060 / LPLA060SF**

### FINITURE LAVABO

WASHBASIN FINISHES

Bianco/white - glossy

Le Terre di Cielo

- |                                       |  |
|---------------------------------------|--|
| <input type="checkbox"/> TL - Talco   | <input type="checkbox"/> AN - Arenaria |
| <input type="checkbox"/> PM - Pomice  | <input type="checkbox"/> AV - Avena    |
| <input type="checkbox"/> BR - Brina   | <input type="checkbox"/> LN - Lino     |
| <input type="checkbox"/> BA - Basalto | <input type="checkbox"/> AG - Agave    |
| <input type="checkbox"/> LV - Lavagna | <input type="checkbox"/> MU - Muschio  |
| <input type="checkbox"/> CM - Cemento | <input type="checkbox"/> PL - Polvere  |
| <input type="checkbox"/> FN - Fango   | <input type="checkbox"/> CP - Cipria   |
| <input type="checkbox"/> CA - Cacao   | <input type="checkbox"/> CN - Canapa   |

Le Acque di Cielo

- |   |
|---|
| <input type="checkbox"/> OL - Oltremare |
| <input type="checkbox"/> SM - Smeraldo  |
| <input type="checkbox"/> AL - Alga      |
| <input type="checkbox"/> CO - Corallo   |
| <input type="checkbox"/> NI - Ninfea    |
| <input type="checkbox"/> AM - Anemone   |

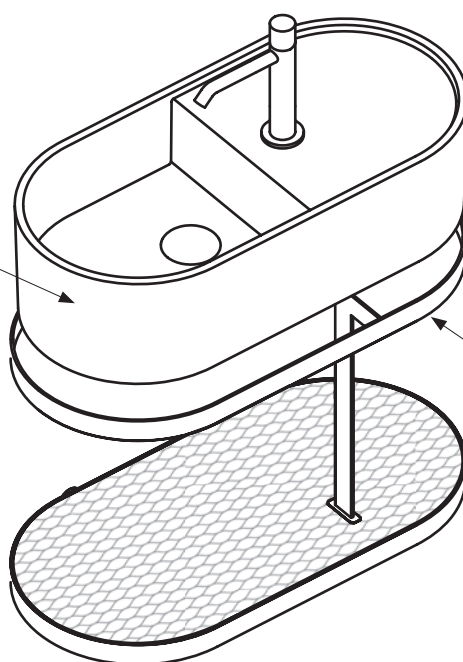

art. **LPST0R60**

### FINITURE STRUTTURA E RETE METALLICA

FRAMEWORK AND WIRE MESH FINISHES

verniciature\_coatings

- |   |
|---|
| <input type="checkbox"/> NM - Nero Matt |
| <input type="checkbox"/> CM - Cemento   |

Le Acque di Cielo

- |   |                                       |
|---|---------------------------------------|
| <input type="checkbox"/> OL - Oltremare | <input type="checkbox"/> CO - Corallo |
| <input type="checkbox"/> SM - Smeraldo  | <input type="checkbox"/> NI - Ninfea  |
| <input type="checkbox"/> AL - Alga      | <input type="checkbox"/> AM - Anemone |

**DATA**

DATE

**FIRMA DEL CLIENTE**

SIGNATURE

ATTENZIONE:

La rappresentazione delle finiture è puramente indicativa. Verificare le finiture con le relative cartelle.

Ogni oggetto possiede la peculiarità di essere elaborato secondo principi puramente tradizionali, in modo da garantirne l'assoluta originalità ed unicità. Le eventuali piccole variazioni di colore, tono o venature fra gli articoli sono da considerarsi pregi e non difetti, in quanto garanzia della fattura manuale del prodotto, che fa di ogni oggetto Cielo un pezzo unico ed esclusivo, lontano dall'omologazione industriale. In fase d'ordine si intendono, pertanto, accettate tali tolleranze che non possono dare adito a contestazioni di alcun genere.

Verificare sempre le disponibilità e i tempi di consegna con il commerciale.

ATTENTION:

The representation of the finishes is merely indicative. Please choose the finishes using the folders.

Every item possesses that particular feature of being processed according to purely traditional principles that guarantee its absolute originality and uniqueness. The small variations in colour, hues or streaks on the items are to be considered as qualities and not defects, since they warranty the handcrafted processing which makes each Cielo item a unique and exclusive piece that cannot be compared to industrial standardization. When making the order, the client implicitly accepts those various features that may give rise to claims of any sort.

Always check the availability and delivery time with the commercial department.

# Les Petites 60

modelli disponibili / available models

## LES PETITES

collection

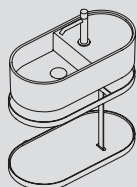

**Les Petites ovale 60 con piano in ceramica**  
Les Petites oval 60 with ceramic shelf  
60 x 30 x 56 h



finiture / finishes

### LAVABO IN CERAMICA / CERAMIC WASHBASIN

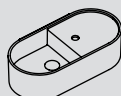

LPLA060

#### Le Terre di Cielo

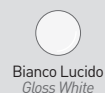

LPLA060SF

#### Le Acque di Cielo



### STRUTTURA IN ACCIAIO / STEEL FRAMEWORK

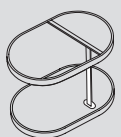

LPST060

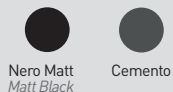

#### Le Acque di Cielo



### PIANO IN CERAMICA / CERAMIC SHELF



LPPIO60

#### Le Terre di Cielo

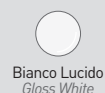

#### Le Acque di Cielo



note tecniche lavabo / washbasin technical notes

monoforo  
one tap hole

senza foro su richiesta  
no tap hole on request

senza troppopieno  
without overflow

installazione da piano  
on top installation

installazione sospesa  
wall-hung installation

con un lato non smaltato  
one side is unglazed

composizione obbligatoria:  
lavabo + struttura + piano  
mandatory composition:  
washbasin + framework +  
shelf

# Modulo Ordine Les Petites Ovale 60 con piano in ceramica

## Les Petites Ovale 60 with ceramic shelf Order Form

# cielo

CLIENTE/client:  ORD. REF.:

QUANTITÀ/quantity:  EMAIL:

**INDICARE CON UN SEGNO LE FINITURE SCELTE PER I DIVERSI COMPONENTI**

**INDICATE WITH A TICK, THE CHOOSEN FINISHES FOR ALL THE COMPONENTS**

art. **LPLA060 / LPLA060SF**

### FINITURE LAVABO

WASHBASIN FINISHES

Bianco/white - glossy

Le Terre di Cielo

- |                                    |                                     |
|------------------------------------|-------------------------------------|
| <input type="radio"/> TL - Talco   | <input type="radio"/> AN - Arenaria |
| <input type="radio"/> PM - Pomice  | <input type="radio"/> AV - Avena    |
| <input type="radio"/> BR - Brina   | <input type="radio"/> LN - Lino     |
| <input type="radio"/> BA - Basalto | <input type="radio"/> AG - Agave    |
| <input type="radio"/> LV - Lavagna | <input type="radio"/> MU - Muschio  |
| <input type="radio"/> CM - Cemento | <input type="radio"/> PL - Polvere  |
| <input type="radio"/> FN - Fango   | <input type="radio"/> CP - Cipria   |
| <input type="radio"/> CA - Cacao   | <input type="radio"/> CN - Canapa   |

Le Acque di Cielo

- OL - Oltremare
- SM - Smeraldo
- AL - Alga
- CO - Corallo
- NI - Ninfea
- AM - Anemone

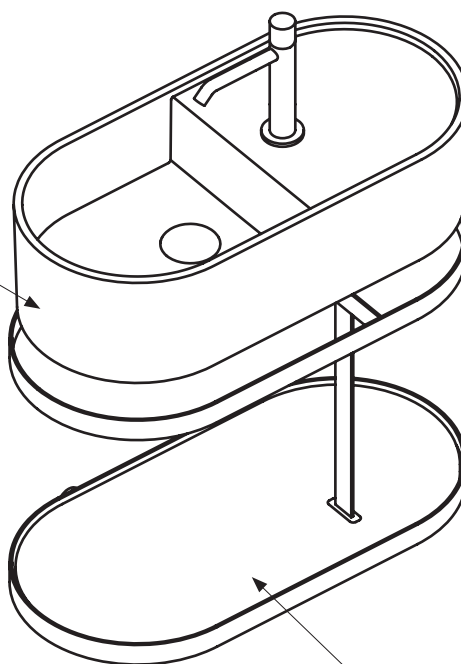

art. **LPST060**

### FINITURE STRUTTURA

FRAMEWORK FINISHES

verniciature\_coatings

NM - Nero Matt

CM - Cemento

Le Acque di Cielo

- |                                      |                                    |
|--------------------------------------|------------------------------------|
| <input type="radio"/> OL - Oltremare | <input type="radio"/> CO - Corallo |
| <input type="radio"/> SM - Smeraldo  | <input type="radio"/> NI - Ninfea  |
| <input type="radio"/> AL - Alga      | <input type="radio"/> AM - Anemone |

art. **LPPI060**

### FINITURE PIANO

SHELF FINISHES

Bianco/white - glossy

Le Terre di Cielo

- |                                    |                                     |
|------------------------------------|-------------------------------------|
| <input type="radio"/> TL - Talco   | <input type="radio"/> AN - Arenaria |
| <input type="radio"/> PM - Pomice  | <input type="radio"/> AV - Avena    |
| <input type="radio"/> BR - Brina   | <input type="radio"/> LN - Lino     |
| <input type="radio"/> BA - Basalto | <input type="radio"/> AG - Agave    |
| <input type="radio"/> LV - Lavagna | <input type="radio"/> MU - Muschio  |
| <input type="radio"/> CM - Cemento | <input type="radio"/> PL - Polvere  |
| <input type="radio"/> FN - Fango   | <input type="radio"/> CP - Cipria   |
| <input type="radio"/> CA - Cacao   | <input type="radio"/> CN - Canapa   |

Le Acque di Cielo

- OL - Oltremare
- SM - Smeraldo
- AL - Alga
- CO - Corallo
- NI - Ninfea
- AM - Anemone

**DATA**  
DATE

**FIRMA DEL CLIENTE**  
SIGNATURE

**ATTENZIONE:**  
La rappresentazione delle finiture è puramente indicativa. Verificare le finiture con le relative cartelle.

Ogni oggetto possiede la peculiarità di essere elaborato secondo principi puramente tradizionali, in modo da garantire l'assoluta originalità ed unicità. Le eventuali piccole variazioni di colore, tono o venature fra gli articoli sono da considerarsi pregi e non difetti, in quanto garanzia della fattura manuale del prodotto, che fa di ogni oggetto Cielo un pezzo unico ed esclusivo, lontano dall'omologazione industriale. In fase d'ordine si intendono, pertanto, accettate tali tolleranze che non possono dare adito a contestazioni di alcun genere.





















Verificare sempre le disponibilità e i tempi di consegna con il commerciale.

**ATTENTION:**  
The representation of the finishes is merely indicative. Please choose the finishes using the folders.

Every item possesses that particular feature of being processed according to purely traditional principles that guarantee its absolute originality and uniqueness. The small variations in colour, hues or streaks on the items are to be considered as qualities and not defects, since they warranty the handcrafted processing which makes each Cielo item a unique and exclusive piece that cannot be compared to industrial standardization. When making the order, the client implicitly accepts those various features that may give rise to claims of any sort.

Always check the availability and delivery time with the commercial department.



	Size (cm)	Product code	Net weight (kg)	Finishes	Euro	Pz. pallet Italia	Pz. pallet Cont.
	Medidas Dimensions Maße Размеры	Artículo Article Artikel Артикул	Peso neto Poids net Reingewicht вес нетто	Acabados Finitions Farbe Отделки	Euro		
 <p><b>Round washbasin with one hole</b> Lavabo ronda con 1 agujero \ Lavabo tour monotrou \ Aufsatzbecken Runde 1-Loch \ Раковина круглый одно отверстие под смеситель</p>	 <p>28 x 28 x 11,5 h</p>	<p><b>LPLAT(X)*</b> with tap hole ø25 orificio para grifo ø25 trou de robinetterie ø25 Hahnloch ø25 отверстие под смеситель ø25</p>	4,00	 <b>Gloss White</b>  <b>Le Terre di Cielo</b>  <b>Le Acque di Cielo</b>	<p>277,00 413,00 413,00</p>	84	126
		<p><b>LPLATFG(X)*</b> with tap hole ø35 orificio para grifo ø35 trou de robinetterie ø35 Hahnloch ø35 отверстие под смеситель ø35</p>					
		<p><b>LPLATSF(X)*</b> no tap hole sin agujero - sans orifice - ohne Loch без отверстия</p>					
 <p><b>Square washbasin with one hole</b> Lavabo cuadrato con 1 agujero \ Lavabo carré monotrou \ Aufsatzbecken quadratisch 1-Loch \ Раковина квадрат одно отверстие под смеситель</p>	 <p>28 x 28 x 11,5 h</p>	<p><b>LPLAQ(X)*</b> with tap hole ø25 orificio para grifo ø25 trou de robinetterie ø25 Hahnloch ø25 отверстие под смеситель ø25</p>	4,00	 <b>Gloss White</b>  <b>Le Terre di Cielo</b>  <b>Le Acque di Cielo</b>	<p>277,00 413,00 413,00</p>	84	126
		<p><b>LPLAOFG(X)*</b> with tap hole ø35 orificio para grifo ø35 trou de robinetterie ø35 Hahnloch ø35 отверстие под смеситель ø35</p>					
		<p><b>LPLAQSF(X)*</b> no tap hole sin agujero - sans orifice - ohne Loch без отверстия</p>					
 <p><b>Oval washbasin with one hole</b> Lavabo ovale con 1 agujero \ Lavabo oval monotrou \ Aufsatzbecken oval 1-Loch \ Раковина овальный одно отверстие под смеситель</p>	 <p>33,5 x 18,5 x 11,5 h</p>	<p><b>LPLAO(X)*</b> with tap hole ø25 orificio para grifo ø25 trou de robinetterie ø25 Hahnloch ø25 отверстие под смеситель ø25</p>	4,00	 <b>Gloss White</b>  <b>Le Terre di Cielo</b>  <b>Le Acque di Cielo</b>	<p>335,00 450,00 450,00</p>	60	100
		<p><b>LPLAOFG(X)*</b> with tap hole ø35 orificio para grifo ø35 trou de robinetterie ø35 Hahnloch ø35 отверстие под смеситель ø35</p>					
		<p><b>LPLAOSF(X)*</b> no tap hole sin agujero - sans orifice - ohne Loch без отверстия</p>					
 <p><b>Rectangular washbasin with one hole</b> Lavabo rectangular con 1 agujero \ Lavabo rectangulaire monotrou \ Aufsatzbecken rechteckig 1-Loch \ Раковина прямоугольная одно отверстие под смеситель</p>	 <p>33,5 x 18,5 x 11,5 h</p>	<p><b>LPLAR(X)*</b> with tap hole ø25 orificio para grifo ø25 trou de robinetterie ø25 Hahnloch ø25 отверстие под смеситель ø25</p>	4,00	 <b>Gloss White</b>  <b>Le Terre di Cielo</b>  <b>Le Acque di Cielo</b>	<p>335,00 450,00 450,00</p>	60	100
		<p><b>LPLARFG(X)*</b> with tap hole ø35 orificio para grifo ø35 trou de robinetterie ø35 Hahnloch ø35 отверстие под смеситель ø35</p>					
		<p><b>LPLARSF(X)*</b> no tap hole sin agujero - sans orifice - ohne Loch без отверстия</p>					

### Technical symbols legend

Simbolos técnicos clave | Légende symboles techniques | Technische Zeichenerklärung | Перечень технических символов

 all sides are enamelled  
con todos los lados esmaltados  
avec tous les côtés émaillés  
alle Seiten glasiert  
все стороны покрыты эмалью

 one tap hole  
con 1 agujero monotrou  
1-Loch  
одно отверстие под смеситель

















 no tap hole on request  
sin agujero, solo a petición  
sans orifice sur demande  
auf Anfrage ohne Loch  
без отверстия под смеситель по запросу

 without overflow  
sin rebosadero  
sans trop-plein  
ohne Überlauf  
без слива-перелива

 on top installation  
instalación de apoyo  
installation à partir du plan  
Montage auf Platte  
установка на столешницу

- Le Terre di Cielo  TL - Talco  PM - Pomice  BR - Brina  BA - Basalto  LV - Lavagna  CM - Cemento  FN - Fango  CA - Cacao
-  AN - Arenaria  AV - Avena  LN - Lino  AG - Agave  MU - Muschio  PL - Polvere  CP - Cipria  CN - Canapa
- Le Acque di Cielo  OL - Oltremare  SM - Smeraldo  AL - Alga  CO - Corallo  NI - Ninfea  AM - Anemone



























	Size (cm) Medidas Dimensions Maße Размеры	Product code Artículo Article Artikel Артикул	Net weight (Kg) Peso neto Poids net Reingewicht вес нетто	Finishes Acabados Finitions Farbe Отделки	Euro Euro	Pz. pallet Italia	Pz. pallet Cont.
 <p><b>Square 35 washbasin with one hole</b> Lavabo cuadrato 35 con 1 agujero \ Lavabo carrè 35 monotrou \ Aufsatzbecken quadratisch 35 1-Loch \ Раковина 35 квадрат одно отверстие под смеситель</p>	35 x 35 x 16 h	LPLAQ35(X)* LPLAQ35SF(X)* no tap hole sin agujero - sans orifice - ohne Loch без отверстия	9,50	 <b>Gloss White</b>  <b>Le Terre di Cielo</b>  <b>Le Acque di Cielo</b>	296,00 423,00 423,00	24	48
 <p><b>Oval 46 washbasin with one hole</b> Lavabo ovale 46 con 1 agujero \ Lavabo 46 oval monotrou \ Aufsatzbecken oval 46 1-Loch \ Раковина овальный одно отверстие под смеситель 46</p>	46 x 30 x 16h	LPLA046(X)* LPLA046SF(X)* no tap hole sin agujero - sans orifice - ohne Loch без отверстия	9,00	 <b>Gloss White</b>  <b>Le Terre di Cielo</b>  <b>Le Acque di Cielo</b>	461,00 520,00 520,00	18	34
 <p><b>Oval 60 washbasin with one hole</b> Lavabo ovale 60 con 1 agujero \ Lavabo 60 oval monotrou \ Aufsatzbecken oval 60 1-Loch \ Раковина овальный одно отверстие под смеситель 60</p>	60 x 30 x 16h	LPLA060(X)* LPLA060SF(X)* no tap hole sin agujero - sans orifice - ohne Loch без отверстия	11,50	 <b>Gloss White</b>  <b>Le Terre di Cielo</b>  <b>Le Acque di Cielo</b>	605,00 868,00 868,00	18	34
 <p><b>On top bowl Tino Mini</b> Cubela de apoyo Tino Mini \ Vasque à poser Tino Mini \ Aufsatzbecken Tino Mini \ Накладная чаша Tino Mini</p>	ø30 x 14,5 h	BAT030(X)*	5,00	 <b>Gloss White</b>  <b>Le Terre di Cielo</b>  <b>Le Acque di Cielo</b>	296,00 423,00 423,00	42	94
<p>art. LPLAQ35/LPLAQ35SF/LPLA046/LPLA046SF/LPLA060/LPLA060SF: for on top installation customers are advised to the require the "RETTIFICA" option; para instalaciones de apoyo se aconseja usar la opción "RETTIFICA" / Pour l'installation à poser on conseille l'option "RETTIFICA" / Bei Aufsatzmontage bitte die Option "RETTIFICA" anfragen / При установке на столешницу рекомендуется запросить опцию "RETTIFICA".</p>					10,00		





## Technical symbols legend

Simbolos técnicos clave | Légende symboles techniques | Technische Zeichenerklärung | Перечень технических символов



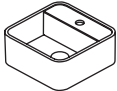





















 <p><b>one side is unglazed</b> con un lado sin esmaltar avec un côté non émaillé eine Seite unglasiert одна сторона не покрыта эмалью</p>	 <p><b>one tap hole</b> con 1 agujero monotrou 1-Loch одно отверстие под смеситель</p>	 <p><b>no tap hole on request</b> sin agujero, solo a petición sans orifice sur demande auf Anfrage ohne Loch без отверстия под смеситель по запросу</p>	 <p><b>no tap holes</b> sin agujero para grifo sans orifice robinet ohne Hahnloch без отверстия под смеситель</p>	 <p><b>without overflow</b> sin rebosadero sans trop-plein ohne Überlauf без слива-перелива</p>
 <p><b>on top installation</b> instalación de apoyo installation à partir du plan Montage auf Platte установка на столешницу</p>	 <p><b>wall-hung installation</b> instalación suspendida installation suspendue wandhängende Montage подвесная установка</p>	 <p><b>with fixing parts</b> fijaciones incluidas fixations incluses inklusive Befestigungen в комплекте с крепежами</p>		

Le Terre di Cielo	 TL - Talco	 PM - Pomice	 BR - Brina	 BA - Basalto	 LV - Lavagna	 CM - Cemento	 FN - Fango	 CA - Cacao
	 AN - Arenaria	 AV - Avena	 LN - Lino	 AG - Agave	 MU - Muschio	 PL - Polvere	 CP - Cipria	 CN - Canapa
Le Acque di Cielo	 OL - Oltremare	 SM - Smeraldo	 AL - Alga	 CO - Corallo	 NI - Ninfea	 AM - Anemone		

	<b>Product code</b> Artículo Article Artikel Артикул	<b>Net weight</b> (kg) Peso neto Poids net Reingewicht вес нетто	<b>Finishes</b> Acabados Finitions Farbe Отделки	<b>Euro</b> Евро
 <p><b>Universal click/clack drain in CHROME with ceramic lid</b> Válvula universal click/clack Cromado con tapa en cerámica \ Bonde universelle clic/clac Chromé avec clapet en céramique \ Universal-Ablaufgarnitur Click-Clack Chrom mit Keramikstopfen \ Универсальный донный клапан click/clack хром с керамической крышкой</p>	PIL01(X)*	0,40	<ul style="list-style-type: none"> <li> <b>Gloss White</b></li> <li> <b>Le Terre di Cielo</b></li> <li> <b>Le Acque di Cielo</b></li> </ul>	<p><b>95,00</b></p> <p><b>139,00</b></p> <p><b>139,00</b></p>
 <p><b>Universal click/clack drain in BLACK MATT finish with ceramic lid</b> Válvula universal click/clack Negro Matt con tapa en cerámica \ Bonde universelle clic/clac Noir Mat avec clapet en céramique \ Universal-Ablaufgarnitur Click-Clack Matt Schwarz mit Keramikstopfen \ Универсальный донный клапан click/clack черный матовый с керамической крышкой</p>	PIL01NM(X)*	0,40	<ul style="list-style-type: none"> <li> <b>Gloss White</b></li> <li> <b>Le Terre di Cielo</b></li> <li> <b>Le Acque di Cielo</b></li> </ul>	<p><b>120,00</b></p> <p><b>169,00</b></p> <p><b>169,00</b></p>
 <p><b>Universal click/clack drain in CEMENTO finish with ceramic lid</b> Válvula universal click/clack Cemento con tapa en cerámica \ Bonde universelle clic/clac Cemento avec clapet en céramique \ Universal-Ablaufgarnitur Click-Clack Cement mit Keramikstopfen \ Универсальный донный Cemento click/clack с керамической крышкой</p>	PIL01CM(X)*	0,40	<ul style="list-style-type: none"> <li> <b>Gloss White</b></li> <li> <b>Le Terre di Cielo</b></li> <li> <b>Le Acque di Cielo</b></li> </ul>	<p><b>120,00</b></p> <p><b>169,00</b></p> <p><b>169,00</b></p>
 <p><b>Universal click/clack drain in BRONZE with ceramic lid</b> Válvula universal click/clack Bronce con tapa en cerámica \ Bonde universelle clic/clac Bronze avec clapet en céramique \ Universal-Ablaufgarnitur Click-Clack Bronze mit Keramikstopfen \ Универсальный донный клапан click/clack бронза с керамической крышкой</p>	PIL01BR(X)*	0,40	<ul style="list-style-type: none"> <li> <b>Gloss White</b></li> <li> <b>Le Terre di Cielo</b></li> <li> <b>Le Acque di Cielo</b></li> </ul>	<p><b>135,00</b></p> <p><b>182,00</b></p> <p><b>182,00</b></p>
 <p><b>CHROMED siphon</b> Sifone Cromado \ Siphon Chromé \ Siphon Verchromt \ сифон Chrome</p>	SISP	0,93	<ul style="list-style-type: none"> <li> <b>Chrome</b></li> </ul>	<b>133,00</b>
 <p><b>MATT BLACK siphon</b> Sifone Negro Mate \ Siphon Noir Mat \ Siphon Schwarz Matt \ Сифон Черный матовый</p>	SIFN	0,93	<ul style="list-style-type: none"> <li> <b>Matt Black</b></li> </ul>	<b>194,00</b>
 <p><b>CEMENTO siphon</b> Sifone Cemento \ Siphon Cemento \ Siphon Cemento \ сифон Cemento</p>	SIFCM	0,93	<ul style="list-style-type: none"> <li> <b>Cemento</b></li> </ul>	<b>194,00</b>
 <p><b>BRONZE siphon</b> Sifone Bronce \ Siphon Bronze \ Siphon Bronze \ бронза сифон</p>	SIFBR	0,93	<ul style="list-style-type: none"> <li> <b>Bronze</b></li> </ul>	<b>220,00</b>

	<b>Size (cm)</b> Medidas Dimensions Maße Размеры	<b>Product code</b> Artículo Article Artikel Артикул	<b>Net weight (Kg)</b> Peso neto Poids net Reingewicht вес нетто	<b>Finishes</b> Acabados Finitions Farbe Отделка	<b>Euro</b> Евро
 <p><b>Square 35 washbasin with one hole</b>                      Lavabo cuadrato 35 con 1 agujero \ Lavabo carrè 35 monotrou                      \ Aufsatzbecken quadratisch 35 1-Loch \ Раковина 35 квадрат                      одно отверстие под смеситель</p>	35 x 35 x 16 h	LPLAQ35(X)* LPLAQ35SF(X)* no tap hole sin agujero - sans orifice - ohne Loch без отверстия	9,50	<ul style="list-style-type: none"> <li><span style="display: inline-block; width: 10px; height: 10px; background-color: white; border: 1px solid black; border-radius: 50%; margin-right: 5px;"></span> Gloss White</li> <li><span style="display: inline-block; width: 10px; height: 10px; background-color: #8B4513; border: 1px solid black; border-radius: 50%; margin-right: 5px;"></span> Le Terre di Cielo</li> <li><span style="display: inline-block; width: 10px; height: 10px; background-color: #008080; border: 1px solid black; border-radius: 50%; margin-right: 5px;"></span> Le Acque di Cielo</li> </ul>	296,00 423,00 423,00
<p style="text-align: center;">+</p>  <p><b>Steel framework with wire mesh</b>                      Estructura de acero con malla de alambre                      Structure en acier avec treillis métallique                      Stahlgestell mit Maschendraht                      Стальной каркас с проволочной сеткой</p>	41 x 35 x 40 h	LPSTQR35(X)*	4,50	<ul style="list-style-type: none"> <li><span style="display: inline-block; width: 10px; height: 10px; background-color: black; border: 1px solid black; border-radius: 50%; margin-right: 5px;"></span> *X = NM - Matt Black</li> <li><span style="display: inline-block; width: 10px; height: 10px; background-color: #666; border: 1px solid black; border-radius: 50%; margin-right: 5px;"></span> *X = CM - Cemento</li> <li><span style="display: inline-block; width: 10px; height: 10px; background-color: #008080; border: 1px solid black; border-radius: 50%; margin-right: 5px;"></span> Le Acque di Cielo</li> </ul>	805,00 831,00 874,00
<p style="text-align: center;">!</p>  <p><b>Steel framework</b>                      Estructura de acero                      Structure en acier                      Stahlgestell                      Стальной каркас</p>	41 x 35 x 40 h	LPSTQ35(X)*	5,00	<ul style="list-style-type: none"> <li><span style="display: inline-block; width: 10px; height: 10px; background-color: black; border: 1px solid black; border-radius: 50%; margin-right: 5px;"></span> *X = NM - Matt Black</li> <li><span style="display: inline-block; width: 10px; height: 10px; background-color: #666; border: 1px solid black; border-radius: 50%; margin-right: 5px;"></span> *X = CM - Cemento</li> <li><span style="display: inline-block; width: 10px; height: 10px; background-color: #008080; border: 1px solid black; border-radius: 50%; margin-right: 5px;"></span> Le Acque di Cielo</li> </ul>	611,00 638,00 672,00
<p style="text-align: center;">+</p>  <p><b>Ceramic shelf (mandatory)</b>                      Encimera de cerámica (obligatorio)                      Plaque en céramique (nécessaire)                      Regal aus Keramik (geböten)                      Керамическая столешница (обязательный)</p>	33 x 33 x 1,2 h	LPPIQ35(X)*	3,00	<ul style="list-style-type: none"> <li><span style="display: inline-block; width: 10px; height: 10px; background-color: white; border: 1px solid black; border-radius: 50%; margin-right: 5px;"></span> Gloss White</li> <li><span style="display: inline-block; width: 10px; height: 10px; background-color: #8B4513; border: 1px solid black; border-radius: 50%; margin-right: 5px;"></span> Le Terre di Cielo</li> <li><span style="display: inline-block; width: 10px; height: 10px; background-color: #008080; border: 1px solid black; border-radius: 50%; margin-right: 5px;"></span> Le Acque di Cielo</li> </ul>	215,00 249,00 249,00

**!** **mandatory combination: lavabo + framework**  
 combinaison obligatoire: cubela + estructura \ combinación obligatoria: vasque + structure \  
 obligatorische Kombination: Becken + gestell \ **обязательное сочетание: Накладная + структура**

	Product code Artículo Article Artikel Артикул	Net weight(kg) Peso neto Poids net Reingewicht вес нетто	Finishes Acabados Finitions Farbe Отделки	Euro Евро
 <p><b>Universal click/clack drain in CHROME with ceramic lid</b> Válvula universal click/clack Cromado con tapa en cerámica \ Bonde universelle clic/clac Chromé avec clapet en céramique \ Universal-Ablaufgarnitur Click-Clack Chrom mit Keramikstopfen \ Универсальный донный клапан click/clack хром с керамической крышкой</p>	PIL01(X)*	0,40	 <b>Gloss White</b>  <b>Le Terre di Cielo</b>  <b>Le Acque di Cielo</b>	<b>95,00</b> <b>139,00</b> <b>139,00</b>
 <p><b>Universal click/clack drain in BLACK MATT finish with ceramic lid</b> Válvula universal click/clack Negro Matt con tapa en cerámica \ Bonde universelle clic/clac Noir Mat avec clapet en céramique \ Universal-Ablaufgarnitur Click-Clack Matt Schwarz mit Keramikstopfen \ Универсальный донный клапан click/clack черный матовый с керамической крышкой</p>	PIL01NM(X)*	0,40	 <b>Gloss White</b>  <b>Le Terre di Cielo</b>  <b>Le Acque di Cielo</b>	<b>120,00</b> <b>169,00</b> <b>169,00</b>
 <p><b>Universal click/clack drain in CEMENTO finish with ceramic lid</b> Válvula universal click/clack Cemento con tapa en cerámica \ Bonde universelle clic/clac Cemento avec clapet en céramique \ Universal-Ablaufgarnitur Click-Clack Cement mit Keramikstopfen \ Универсальный донный Cemento click/clack с керамической крышкой</p>	PIL01CM(X)*	0,40	 <b>Gloss White</b>  <b>Le Terre di Cielo</b>  <b>Le Acque di Cielo</b>	<b>120,00</b> <b>169,00</b> <b>169,00</b>
 <p><b>Universal click/clack drain in BRONZE with ceramic lid</b> Válvula universal click/clack Bronce con tapa en cerámica \ Bonde universelle clic/clac Bronze avec clapet en céramique \ Universal-Ablaufgarnitur Click-Clack Bronze mit Keramikstopfen \ Универсальный донный клапан click/clack бронза с керамической крышкой</p>	PIL01BR(X)*	0,40	 <b>Gloss White</b>  <b>Le Terre di Cielo</b>  <b>Le Acque di Cielo</b>	<b>135,00</b> <b>182,00</b> <b>182,00</b>
 <p><b>CHROMED siphon</b> Sifone Cromado \ Siphon Chromé \ Siphon Verchromt \ сифон Chrome</p>	SISP	0,93	 <b>Chrome</b>	<b>133,00</b>
 <p><b>MATT BLACK siphon</b> Sifone Negro Mate \ Siphon Noir Mat \ Siphon Schwarz Matt \ Сифон Черный матовый</p>	SIFN	0,93	 <b>Matt Black</b>	<b>194,00</b>
 <p><b>CEMENTO siphon</b> Sifone Cemento \ Siphon Cemento \ Siphon Cemento \ сифон Cemento</p>	SIFCM	0,93	 <b>Cemento</b>	<b>194,00</b>
 <p><b>BRONZE siphon</b> Sifone Bronce \ Siphon Bronce \ Siphon Bronce \ бронза сифон</p>	SIFBR	0,93	 <b>Bronze</b>	<b>220,00</b>

## Technical symbols legend

Simbolos técnicos clave | Légende symboles techniques | Technische Zeichenerklärung | Перечень технических символов

 **wall-hung installation**  
instalación suspendida  
installation suspendue  
wandhängende Montage  
подвесная установка

 **with fixing parts**  
fijaciones incluidas  
fixations incluses  
inklusive Befestigungen  
в комплекте с крепежами

 **on top installation**  
instalación de apoyo  
installation à partir du plan  
Montage auf Platte  
установка на столешницу

 **one side is unglazed**  
con un lado sin esmaltar  
avec un côté non émaillé  
eine Seite unglasiert  
одна сторона не покрыта эмалью

 **one tap hole**  
con 1 agujero  
monotrou  
1-Loch  
одно отверстие под смеситель

 **no tap hole on request**  
sin agujero, solo a petición  
sans orifice sur demande  
auf Anfrage ohne Loch  
без отверстия под смеситель по запросу





 **without overflow**  
sin rebosadero  
sans trop-plein  
ohne Überlauf  
без слива-перелива

**Terre di Cielo available for washbasins and ceramic shelf /**  
Terre di Cielo disponibles para el lavabo y la encimara de cerámica  
| Terre di Cielo disponibles pour le lavabo et le plan en céramique  
| Für Waschbecken und Keramikplatte erhältlich  
Terre di Cielo | Отделка Terre di Cielo доступны для раковины и керамических столешниц





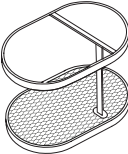
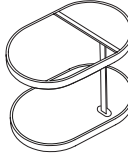



















 TL - Talco   
  PM - Pomice   
  BR - Brina   
  BA - Basalto   
  LV - Lavagna   
  CM - Cemento  
 FN - Fango   
  CA - Cacao   
  AN - Arenaria   
  AV - Avena   
  LN - Lino   
  AG - Agave  
 MU - Muschio   
  PL - Polvere   
  CP - Cipria   
  CN - Canapa

**Acque di Cielo available for washbasins and ceramic shelf e struttura /**  
Acque di Cielo disponibles para el lavabo y la encimara de cerámica  
| Acque di Cielo disponibles pour le lavabo et le plan en céramique  
| Für Waschbecken und Keramikplatte erhältlich  
Acque di Cielo | Отделка Acque di Cielo доступны для раковины и керамических столешниц

 OL - Oltremare   
  SM - Smeraldo   
  AL - Alga   
  CO - Corallo   
  NI - Ninfea   
  AM - Anemone

	<b>Size (cm)</b> Medidas Dimensions Maße Размеры	<b>Product code</b> Artículo Article Artikel Артикул	<b>Net weight (Kg)</b> Peso neto Poids net Reingewicht вес нетто	<b>Finishes</b> Acabados Finitions Farbe Отделки	<b>Euro</b> Евро
 <p><b>Oval 46 washbasin with one hole</b>                      Lavabo ovale 46 con 1 agujero \ Lavabo 46 oval monotrou \ Aufsatzbecken oval 46 1-Loch \ Раковина овальный одно отверстие под смеситель 46</p>	46 x 30 x 16 h	LPLA046(X)* LPLA046SF(X)* no tap hole sin agujero - sans orifice - ohne Loch без отверстия	9,00	<ul style="list-style-type: none"> <li><span style="display: inline-block; width: 10px; height: 10px; border-radius: 50%; background-color: white; margin-right: 5px;"></span> <b>Gloss White</b></li> <li><span style="display: inline-block; width: 10px; height: 10px; border-radius: 50%; background-color: #8B4513; margin-right: 5px;"></span> <b>Le Terre di Cielo</b></li> <li><span style="display: inline-block; width: 10px; height: 10px; border-radius: 50%; background-color: #008080; margin-right: 5px;"></span> <b>Le Acque di Cielo</b></li> </ul>	461,00 520,00 520,00
<p>+</p>  <p><b>Steel framework with wire mesh</b>                      Estructura de acero con malla de alambre                      Structure en acier avec treillis métallique                      Stahlgestell mit Maschendraht                      Стальной каркас с проволочной сеткой</p>	46 x 30 x 40 h	LPSTOR46(X)*	4,00	<ul style="list-style-type: none"> <li><span style="display: inline-block; width: 10px; height: 10px; border-radius: 50%; background-color: black; margin-right: 5px;"></span> *X = <b>NM - Matt Black</b></li> <li><span style="display: inline-block; width: 10px; height: 10px; border-radius: 50%; background-color: #666666; margin-right: 5px;"></span> *X = <b>CM - Cemento</b></li> <li><span style="display: inline-block; width: 10px; height: 10px; border-radius: 50%; background-color: #008080; margin-right: 5px;"></span> <b>Le Acque di Cielo</b></li> </ul>	765,00 796,00 839,00
<p>!</p>  <p><b>Steel framework</b>                      Estructura de acero                      Structure en acier                      Stahlgestell                      Стальной каркас</p>	46 x 30 x 40 h	LPST046(X)*	4,50	<ul style="list-style-type: none"> <li><span style="display: inline-block; width: 10px; height: 10px; border-radius: 50%; background-color: black; margin-right: 5px;"></span> *X = <b>NM - Matt Black</b></li> <li><span style="display: inline-block; width: 10px; height: 10px; border-radius: 50%; background-color: #666666; margin-right: 5px;"></span> *X = <b>CM - Cemento</b></li> <li><span style="display: inline-block; width: 10px; height: 10px; border-radius: 50%; background-color: #008080; margin-right: 5px;"></span> <b>Le Acque di Cielo</b></li> </ul>	582,00 607,00 642,00
<p>+</p>  <p><b>Ceramic shelf</b>                      Encimera de cerámica                      Plaque en céramique                      Regal aus Keramik                      Керамическая столешница</p>	45 x 28 x 1,2 h	LPPI046(X)*	3,00	<ul style="list-style-type: none"> <li><span style="display: inline-block; width: 10px; height: 10px; border-radius: 50%; background-color: white; margin-right: 5px;"></span> <b>Gloss White</b></li> <li><span style="display: inline-block; width: 10px; height: 10px; border-radius: 50%; background-color: #8B4513; margin-right: 5px;"></span> <b>Le Terre di Cielo</b></li> <li><span style="display: inline-block; width: 10px; height: 10px; border-radius: 50%; background-color: #008080; margin-right: 5px;"></span> <b>Le Acque di Cielo</b></li> </ul>	249,00 296,00 296,00

**!** **mandatory combination: lavabo + framework**  
 combinaison obligatoire: cubela + estructura \ combinación obligatoria: vasque + structure \  
 obligatorische Kombination: Becken + gestell \ **обязательное сочетание: Накладная + структура**

	Product code Artículo Article Artikel Артикул	Net weight (Kg) Peso neto Poids net Reingewicht вес нетто	Finishes Acabados Finitions Farbe Отделка	Euro Евро
 <p><b>Universal click/clack drain in CHROME with ceramic lid</b> Válvula universal click/clack Cromado con tapa en cerámica \ Bonde universelle clic/clac Chromé avec clapet en céramique \ Universal-Ablaufgarnitur Click-Clack Chrom mit Keramikstopfen \ Универсальный донный клапан click/clack хром с керамической крышкой</p>	PIL01(X)*	0,40	 <b>Gloss White</b>  <b>Le Terre di Cielo</b>  <b>Le Acque di Cielo</b>	<b>95,00</b> <b>139,00</b> <b>139,00</b>
 <p><b>Universal click/clack drain in BLACK MATT finish with ceramic lid</b> Válvula universal click/clack Negro Matt con tapa en cerámica \ Bonde universelle clic/clac Noir Mat avec clapet en céramique \ Universal-Ablaufgarnitur Click-Clack Matt Schwarz mit Keramikstopfen \ Универсальный донный клапан click/clack черный матовый с керамической крышкой</p>	PIL01NM(X)*	0,40	 <b>Gloss White</b>  <b>Le Terre di Cielo</b>  <b>Le Acque di Cielo</b>	<b>120,00</b> <b>169,00</b> <b>169,00</b>
 <p><b>Universal click/clack drain in CEMENTO finish with ceramic lid</b> Válvula universal click/clack Cemento con tapa en cerámica \ Bonde universelle clic/clac Cemento avec clapet en céramique \ Universal-Ablaufgarnitur Click-Clack Cement mit Keramikstopfen \ Универсальный донный Cemento click/clack с керамической крышкой</p>	PIL01CM(X)*	0,40	 <b>Gloss White</b>  <b>Le Terre di Cielo</b>  <b>Le Acque di Cielo</b>	<b>120,00</b> <b>169,00</b> <b>169,00</b>
 <p><b>Universal click/clack drain in BRONZE with ceramic lid</b> Válvula universal click/clack Bronce con tapa en cerámica \ Bonde universelle clic/clac Bronze avec clapet en céramique \ Universal-Ablaufgarnitur Click-Clack Bronze mit Keramikstopfen \ Универсальный донный клапан click/clack бронза с керамической крышкой</p>	PIL01BR(X)*	0,40	 <b>Gloss White</b>  <b>Le Terre di Cielo</b>  <b>Le Acque di Cielo</b>	<b>135,00</b> <b>182,00</b> <b>182,00</b>
 <p><b>CHROMED siphon</b> Sifone Cromado \ Siphon Chromé \ Siphon Verchromt \ сифон Chrome</p>	SISP	0,93	 <b>Chrome</b>	<b>133,00</b>
 <p><b>MATT BLACK siphon</b> Sifone Negro Mate \ Siphon Noir Mat \ Siphon Schwarz Matt \ Сифон Черный матовый</p>	SIFN	0,93	 <b>Matt Black</b>	<b>194,00</b>
 <p><b>CEMENTO siphon</b> Sifone Cemento \ Siphon Cemento \ Siphon Cemento \ сифон Cemento</p>	SIFCM	0,93	 <b>Cemento</b>	<b>194,00</b>
 <p><b>BRONZE siphon</b> Sifone Bronce \ Siphon Bronce \ Siphon Bronze \ бронза сифон</p>	SIFBR	0,93	 <b>Bronze</b>	<b>220,00</b>

## Technical symbols legend

Simbolos técnicos clave | Légende symboles techniques | Technische Zeichenerklärung | Перечень технических символов

 **wall-hung installation**  
instalación suspendida  
installation suspendue  
wandhängende Montage  
подвесная установка

 **with fixing parts**  
fijaciones incluidas  
fixations incluses  
inklusive Befestigungen  
в комплекте с крепежами

 **on top installation**  
instalación de apoyo  
installation à partir du plan  
Montage auf Platte  
установка на столешницу

 **one side is unglazed**  
con un lado sin esmaltar  
avec un côté non émaillé  
eine Seite unglasiert  
одна сторона не покрыта эмалью

 **one tap hole**  
con 1 agujero  
monotrou  
1-Loch  
одно отверстие под смеситель

 **no tap hole on request**  
sin agujero, solo a petición  
sans orifice sur demande  
auf Anfrage ohne Loch  
без отверстия под смеситель по запросу













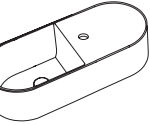



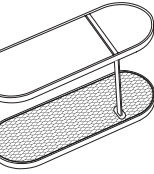

 **without overflow**  
sin rebosadero  
sans trop-plein  
ohne Übertauf  
без слива-перелива

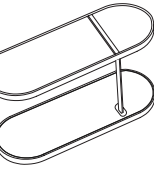
**Terre di Cielo available for washbasins and ceramic shelf / Terre di Cielo disponibles para el lavabo y la encimara de cerámica / Terre di Cielo disponibles pour le lavabo et le plan en céramique / Für Waschbecken und Keramikplatte erhältliche Terre di Cielo / Отделка Terre di Cielo доступны для раковины и керамических столешниц**

 **TL - Talco**  
  **PM - Pomice**  
  **BR - Brina**  
  **BA - Basalto**  
  **LV - Lavagna**  
  **CM - Cemento**  
 **FN - Fango**  
  **CA - Cacao**  
  **AN - Arenaria**  
  **AV - Avena**  
  **LN - Lino**  
  **AG - Agave**  
 **MU - Muschio**  
  **PL - Polvere**  
  **CP - Cipria**  
  **CN - Canapa**

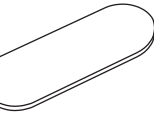























**Acque di Cielo available for washbasins and ceramic shelf e struttura / Acque di Cielo disponibles para el lavabo y la encimara de cerámica / Acque di Cielo disponibles pour le lavabo et le plan en céramique / Für Waschbecken und Keramikplatte erhältliche Acque di Cielo / Отделка Acque di Cielo доступны для раковины и керамических столешниц**

 **OL - Oltremare**  
  **SM - Smeraldo**  
  **AL - Alga**  
  **CO - Corallo**  
  **NI - Ninfea**  
  **AM - Anemone**

	<b>Size (cm)</b> Medidas Dimensions Maße Размеры	<b>Product code</b> Artículo Article Artikel Артикул	<b>Net weight (Kg)</b> Peso neto Poids net Reingewicht вес нетто	<b>Finishes</b> Acabados Finitions Farbe Отделки	<b>Euro</b> Евро
 <p>  </p> <p> <b>Oval 60 washbasin with one hole</b>                      Lavabo ovale 60 con 1 agujero \ Lavabo 60 oval monotrou \ Aufsatzbecken oval 60 1-Loch \ Раковина овальный одно отверстие под смеситель 60                 </p> <p>  </p>	60 x 30 x 16 h	LPLA060(x)* LPLA060SF(x)* no tap hole sin agujero sans orifice ohne Loch без отверстия	11,50	<ul style="list-style-type: none"> <li> <b>Gloss White</b></li> <li> <b>Le Terre di Cielo</b></li> <li> <b>Le Acque di Cielo</b></li> </ul>	605,00 868,00 868,00
<p>+</p>  <p> <b>Steel framework with wire mesh</b>                      Estructura de acero con malla de alambre                      Structure en acier avec treillis métallique                      Stahlgestell mit Maschendraht                      Стальной каркас с проволочной сеткой                 </p>	60 x 30 x 40 h	LPSTOR60(x)*	4,50	<ul style="list-style-type: none"> <li> *X = <b>NM - Matt Black</b></li> <li> *X = <b>CM - Cemento</b></li> <li> <b>Le Acque di Cielo</b></li> </ul>	819,00 846,00 888,00
<p>!</p>  <p> <b>Steel framework</b>                      Estructura de acero                      Structure en acier                      Stahlgestell                      Стальной каркас                 </p>	60 x 30 x 40 h	LPSTO60(x)*	5,00	<ul style="list-style-type: none"> <li> *X = <b>NM - Matt Black</b></li> <li> *X = <b>CM - Cemento</b></li> <li> <b>Le Acque di Cielo</b></li> </ul>	632,00 656,00 690,00
<p>+</p>  <p> <b>Ceramic shelf</b>                      Encimera de cerámica                      Plaque en céramique                      Regal aus keramik                      Керамическая столешница                 </p>	59 x 28 x 1,2 h	LPPI060(x)*	4,50	<ul style="list-style-type: none"> <li> <b>Gloss White</b></li> <li> <b>Le Terre di Cielo</b></li> <li> <b>Le Acque di Cielo</b></li> </ul>	335,00 420,00 420,00

**mandatory combination: lavabo + framework**  
 combinaison obligatoire: cubela + estructura \ combinación obligatoria: vasque + structure \ obligatorische Kombination: Becken + gestell \ обязательное сочетание: Накладная + структура



	<b>Product code</b> Artículo Article Artikel Артикул	<b>Net weight</b> (Kg) Peso neto Poids net Reingewicht вес нетто	<b>Finishes</b> Acabados Finitions Farbe Отделки	<b>Euro</b> Евро
 <b>Universal click/clack drain in CHROME with ceramic lid</b> Válvula universal click/clack Cromado con tapa en cerámica \ Bonde universelle clic/clac Chromé avec clapet en céramique \ Universal-Ablaufgarnitur Click-Clack Chrom mit Keramikstopfen \ Универсальный донный клапан click/clack хром с керамической крышкой	PIL01(X)*	0,40	 <b>Gloss White</b>  <b>Le Terre di Cielo</b>  <b>Le Acque di Cielo</b>	<b>95,00</b> <b>139,00</b> <b>139,00</b>
 <b>Universal click/clack drain in BLACK MATT finish with ceramic lid</b> Válvula universal click/clack Negro Matt con tapa en cerámica \ Bonde universelle clic/clac Noir Mat avec clapet en céramique \ Universal-Ablaufgarnitur Click-Clack Matt Schwarz mit Keramikstopfen \ Универсальный донный клапан click/clack черный матовый с керамической крышкой	PIL01NM(X)*	0,40	 <b>Gloss White</b>  <b>Le Terre di Cielo</b>  <b>Le Acque di Cielo</b>	<b>120,00</b> <b>169,00</b> <b>169,00</b>
 <b>Universal click/clack drain in CEMENTO finish with ceramic lid</b> Válvula universal click/clack Cemento con tapa en cerámica \ Bonde universelle clic/clac Cemento avec clapet en céramique \ Universal-Ablaufgarnitur Click-Clack Cement mit Keramikstopfen \ Универсальный донный Cemento click/clack с керамической крышкой	PIL01CM(X)*	0,40	 <b>Gloss White</b>  <b>Le Terre di Cielo</b>  <b>Le Acque di Cielo</b>	<b>120,00</b> <b>169,00</b> <b>169,00</b>
 <b>Universal click/clack drain in BRONZE with ceramic lid</b> Válvula universal click/clack Bronce con tapa en cerámica \ Bonde universelle clic/clac Bronze avec clapet en céramique \ Universal-Ablaufgarnitur Click-Clack Bronze mit Keramikstopfen \ Универсальный донный клапан click/clack бронза с керамической крышкой	PIL01BR(X)*	0,40	 <b>Gloss White</b>  <b>Le Terre di Cielo</b>  <b>Le Acque di Cielo</b>	<b>135,00</b> <b>182,00</b> <b>182,00</b>
 <b>CHROMED siphon</b> Sifone Cromado \ Siphon Chromé \ Siphon Verchromt \ сифон Chrome	SISP	0,93	 <b>Chrome</b>	<b>133,00</b>
 <b>MATT BLACK siphon</b> Sifone Negro Mate \ Siphon Noir Mat \ Siphon Schwarz Matt \ Сифон Черный матовый	SIFN	0,93	 <b>Matt Black</b>	<b>194,00</b>
 <b>CEMENTO siphon</b> Sifone Cemento \ Siphon Cemento \ Siphon Cemento \ сифон Cemento	SIFCM	0,93	 <b>Cemento</b>	<b>194,00</b>
 <b>BRONZE siphon</b> Sifone Bronce \ Siphon Bronce \ Siphon Bronze \ бронза сифон	SIFBR	0,93	 <b>Bronze</b>	<b>220,00</b>

## Technical symbols legend

Simbolos técnicos clave / Légende symboles techniques / Technische Zeichenerklärung / Перечень технических символов

 **wall-hung installation**  
 instalación suspendida  
 installation suspendue  
 wandhängende Montage  
 подвесная установка

 **with fixing parts**  
 fijaciones incluidas  
 fixations incluses  
 inklusive Befestigungen  
 в комплекте с крепежами

 **on top installation**  
 instalación de apoyo  
 installation à partir du plan  
 Montage auf Platte  
 установка на столешницу

 **one side is unglazed**  
 con un lado sin esmaltar  
 avec un côté non émaillé  
 eine Seite unglasiert  
 одна сторона не покрыта эмалью

 **one tap hole**  
 con 1 agujero  
 monofou  
 1-Loch  
 одно отверстие под смеситель

 **no tap hole on request**  
 sin agujero, solo a petición  
 sans orifice sur demande  
 auf Anfrage ohne Loch  
 без отверстия под смеситель по запросу

 **without overflow**  
 sin rebosadero  
 sans trop-plein  
 ohne Überlauf  
 без слива-перелива

**Terre di Cielo available for washbasins and ceramic shelf**  
 Terre di Cielo disponibles para el lavabo y la encimara de cerámica  
 Terre di Cielo disponibles pour le lavabo et le plan en céramique  
 Für Waschbecken und Keramikplatte erhältliche Terre di Cielo  
 Отделка Terre di Cielo доступны для раковины и керамических столешниц

 TL - Talco  
  PM - Pomice  
  BR - Brina  
  BA - Basalto  
  LV - Lavagna  
  CM - Cemento  
 FN - Fango  
  CA - Cacao  
  AN - Arenaria  
  AV - Avena  
  LN - Lino  
  AG - Agave  
 MU - Muschio  
  PL - Polvere  
  CP - Cipria  
  CN - Canapa

**Acque di Cielo available for washbasins and ceramic shelf e struttura**  
 Acque di Cielo disponibles para el lavabo y la encimara de cerámica  
 Acque di Cielo disponibles pour le lavabo et le plan en céramique  
 Für Waschbecken und Keramikplatte erhältliche Acque di Cielo  
 Отделка Acque di Cielo доступны для раковины и керамических столешниц

 OL - Oltremare  
  SM - Smeraldo  
  AL - Alga  
  CO - Corallo  
  NI - Ninfea  
  AM - Anemone

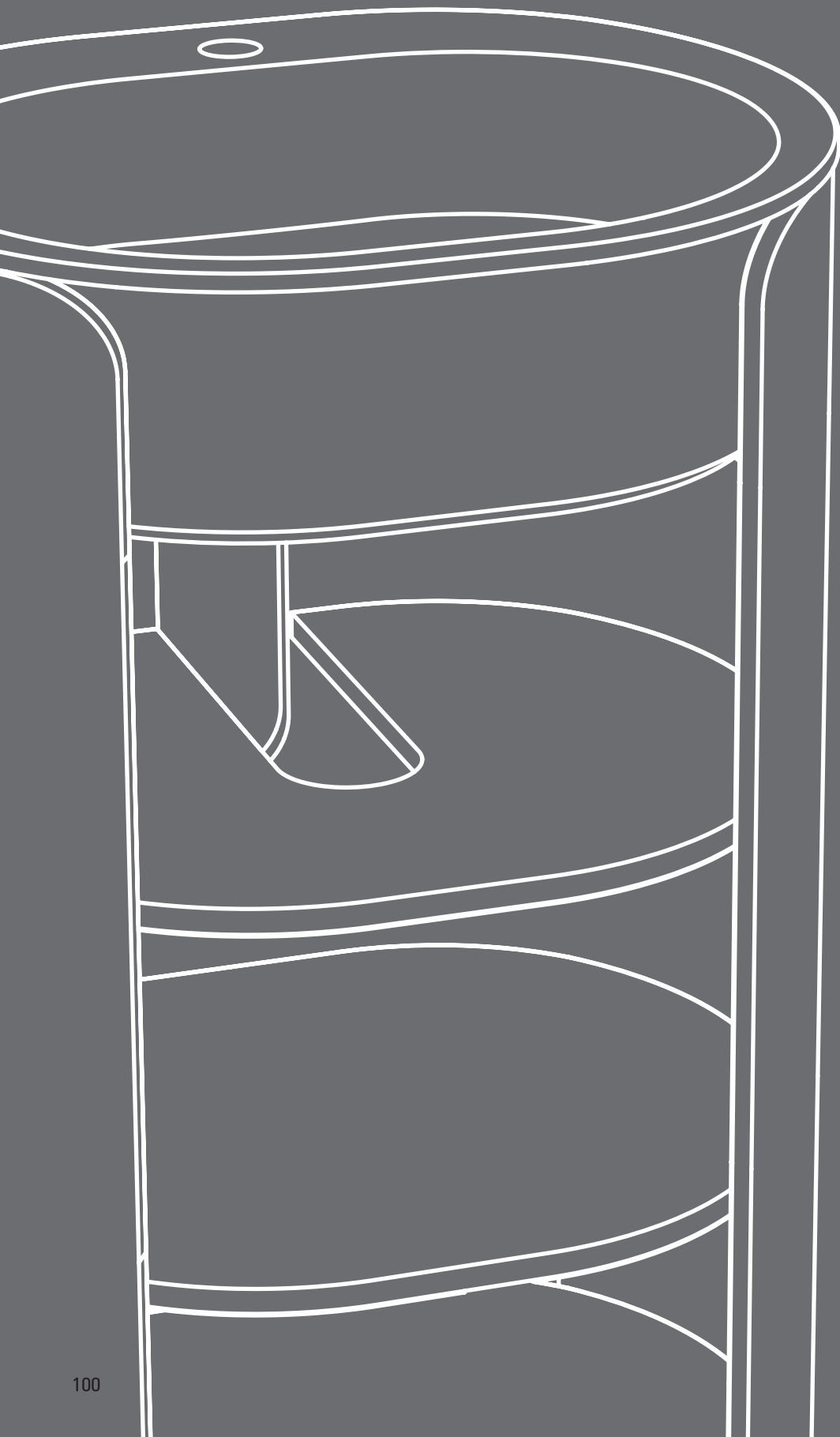

# I Catini

design **Andrea Parisio & Giuseppe Pezzano**

QR code configuratore \ configurator pg. 104 - 105

indice collezione \ collection index pg. 106

moduli d'ordine \ order form pg. 109 - 127

listino prezzi \ price list pg. 130 - 155







## Configure the product directly online and send the order to Cielo.

Configure el producto directamente online y envíe el pedido a Cielo.

Configurez le produit directement en ligne et envoyez la commande à Cielo.

Konfigurieren Sie Ihr Produkt online und schicken Sie die Bestellung direkt an Cielo.

Сконфигурируйте изделие в онлайн и перешлите заказ на фабрику Cielo.

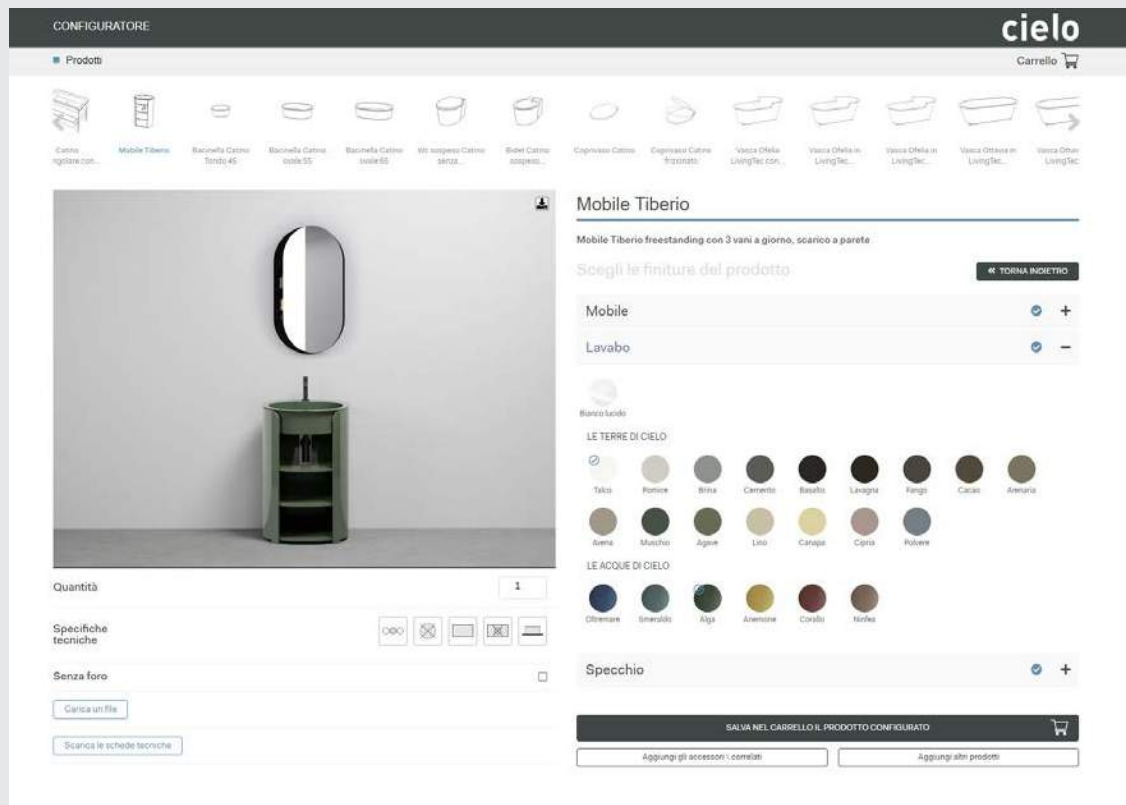

EN



go to the  
configurator

SP

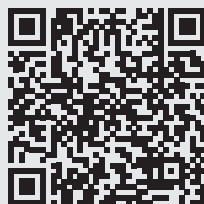

ir al  
configurador

FR

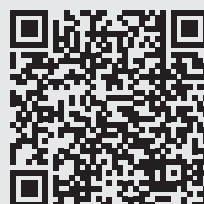

lien vers le  
configurateur

RU

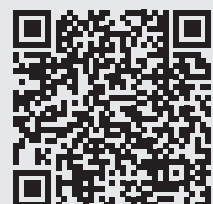

Перейдите в  
конфигуратор

## Configure the product directly online and send the order to Cielo.

Configure el producto directamente online y envíe el pedido a Cielo.

Configurez le produit directement en ligne et envoyez la commande à Cielo.

Konfigurieren Sie Ihr Produkt online und schicken Sie die Bestellung direkt an Cielo.

Сконфигурируйте изделие в онлайн и перешлите заказ на фабрику Cielo.

EN



go to the  
configurator

SP



ir al  
configurador

FR



lien vers le  
configurateur

RU



Перейдите в  
конфигуратор



## Cabinet with washbasin

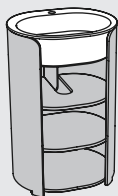

**TIBERIO**  
cm 56 x 48 x 84 h  
pag. 130

## Washbasins



**CALAT45**  
cm ø45 x 16 h  
pag. 132



**CALA055**  
cm 55 x 42 x 16 h  
pag. 132



**CALA065**  
cm 65 x 44 x 16 h  
pag. 132

## Wc - bidet

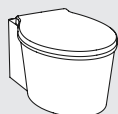

**CAVSK**  
**senza brida / rimless**  
cm 56 x 38 x 27 h  
pag. 134



**CABS**  
cm 56 x 38 x 27 h  
pag. 135

## Shower tray

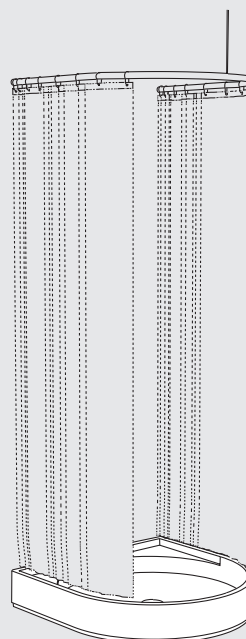

**Augusto**  
**piatto doccia + asta per tenda**  
shower tray + shower rod  
PDCA106 + CAAS

cm 106 x 106 x 20 h + 1035 x 1050  
pag. 140

## Bath tubs\_Baignoire\_Badewanne\_ванна



**Ottavia**  
**CABAT**  
cm 170 x 80 x 56 h  
pag. 138

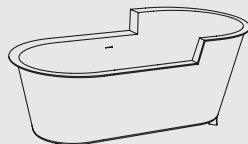

**Ofelia**  
**CASBAT**  
cm 157 x 93 x 69 h  
pag. 139

## Cabinet with washbasin

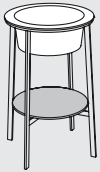

**CATINO TONDO**  
cm ø50 x 83 h  
pag. 142

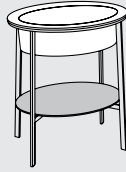

**CATINO OVALE con piano / with shelf**  
cm 70 x 50 x 83 h  
pag. 144

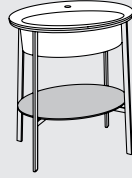

**CATINO OVALE monoforo con piano**  
with 1 hole with shelf  
cm 70 x 50 x 83 h  
pag. 144

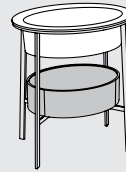

**CATINO OVALE con cassetto / with drawer**  
cm 70 x 50 x 83 h  
pag. 144

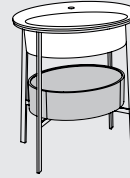

**CATINO OVALE monoforo con cassetto**  
with 1 hole with drawer  
cm 70 x 50 x 83 h  
pag. 144

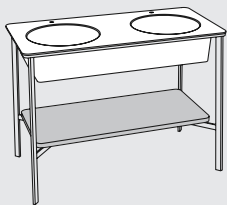

**CATINO DOPPIO con piano / with shelf**  
cm 110 x 58,5 x 83 h  
pag. 148

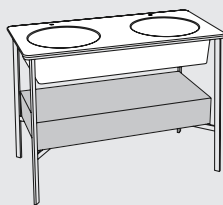

**CATINO DOPPIO con cassetto / with drawer**  
cm 110 x 58,5 x 83 h  
pag. 148

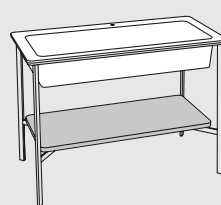

**CATINO RETTANGOLARE con piano / with shelf**  
cm 110 x 58,5 x 83 h  
pag. 150

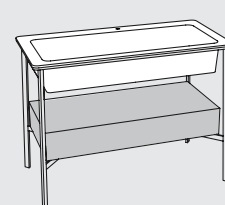

**CATINO RETTANGOLARE con cassetto / with drawer**  
cm 110 x 58,5 x 83 h  
pag. 150

## Mirrors

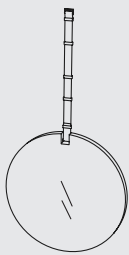

**Specchio con cinta**  
Mirror with belt  
cm ø60  
pag. 153



**Round mirror 60 CASPT60**  
ø60 x 4 cm  
pag. 155



**Round mirror 75 CASPT75**  
ø75 x 4 cm  
pag. 155

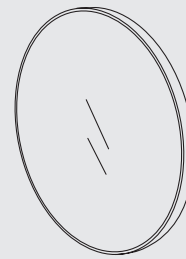

**Round mirror 120 CASPT**  
ø120 x 4 cm  
pag. 155



**Oval mirror CASPO**  
90 x 50 x 4 cm  
pag. 155



**Round Box 75 CASPCT75**  
ø75 x 12 cm  
pag. 155



**Round Box 90 CASPCT**  
ø90 x 12 cm  
pag. 155



**Oval Box CASPCO**  
90 x 50 x 12 cm  
pag. 155

# Tiberio

modelli disponibili / available models

## I CATINI collection

### Tiberio

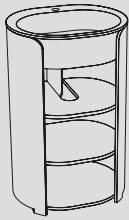

Tiberio

56 x 48 x 84 h



## finiture / finishes

**LAVABO IN CERAMICA / CERAMIC WASHBASIN**

**Le Terre di Cielo**

CALA056F

Talco Pomice Brina Basalto Lavagna Cemento Fango Cacao Arenaria Avena Lino Agave Muschio Polvere Cipria Canapa

**Le Acque di Cielo**

CALA056SF

Oltremare Smeraldo Alga Corallo Ninfea Anemone

Bianco Lucido  
Gloss White

**MOBILE IN LEGNO / WOODEN CABINET**

**laccature / lacquers**

**Le Terre di Cielo**

CAMTL / CAMTE

Talco Pomice Brina Arenaria Avena Cemento Basalto Muschio

**Le Acque di Cielo**

Oltremare Smeraldo Alga Corallo Ninfea Anemone

**essenze / wooden finishes**

Rovere Naturale Rovere Sbiancato Rovere Grigio Rovere Nero

## note tecniche lavabo / washbasin technical notes

-   
**versione monoforo predisposto 3 fori**  
 with 1 tap hole prepared 3 holes version
-   
**senza foro su richiesta**  
 no tap hole on request
-   
**senza troppopieno**  
 without overflow
-   
**installazione su mobile**  
 installation on the cabinet
-   
**con tutti i lati smaltati**  
 all enamelled sides
-   
**abbinamento obbligatorio: lavabo + mobile**  
 mandatory combination: washbasin + cabinet

CLIENTE/client:  ORD. REF.:

QUANTITÀ/quantity:  EMAIL:

**INDICARE CON UN SEGNO LE FINITURE SCELTE PER I DIVERSI COMPONENTI**

*INDICATE WITH A TICK, THE CHOOSEN FINISHES FOR ALL THE COMPONENTS*

art. **CALA056F / CALA056SF**

**FINITURE LAVABO**

WASHBASIN SHELF FINISHES

Bianco/white - glossy

Le Terre di Cielo

- TL - Talco
- AN - Arenaria
- PM - Pomice
- AV - Avena
- BR - Brina
- LN - Lino
- BA - Basalto
- AG - Agave
- LV - Lavagna
- MU - Muschio
- CM - Cemento
- PL - Polvere
- FN - Fango
- CP - Cipria
- CA - Cacao
- CN - Canapa

Le Acque di Cielo

- OL - Oltremare
- SM - Smeraldo
- AL - Alga
- CO - Corallo
- NI - Ninfea
- AM - Anemone

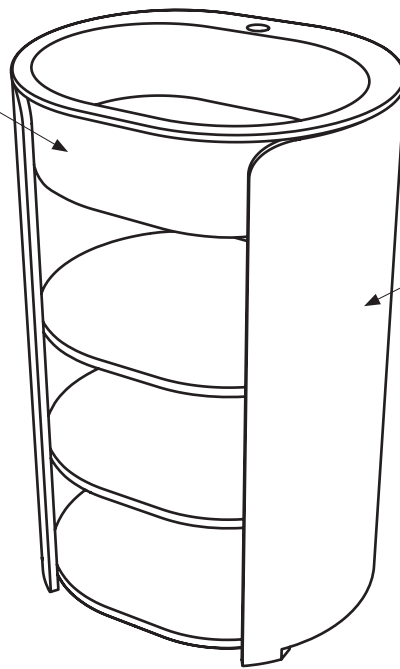

art. **CAMTL / CAMTE**

**FINITURE MOBILE**

CABINET FINISHES

laccature/lacquering

Le Terre di Cielo

- TL - Talco
- CM - Cemento
- PM - Pomice
- AN - Arenaria
- BR - Brina
- AV - Avena
- BA - Basalto
- MU - Muschio

Le Acque di Cielo

- OL - Oltremare
- SM - Smeraldo
- AL - Alga
- CO - Corallo
- NI - Ninfea
- AM - Anemone

essenze legno/wood essences

- RO - Rovere Nero
- RG - Rovere Grigio
- RN - Rovere Naturale
- RS - Rovere Sbiancato

**N.B.**  
**Il lavabo è monoforo predisposto 3 fori, su richiesta può essere prodotto senza foro.**  
**Gli elementi di fissaggio sono sempre neri in tutte le versioni.**

*N.B.*  
*The washbasin has 1 hole prepared 3 holes ; mayay be made without holes upon request.*  
*The fixing elements are always black in all versions.*

**DATA**  
DATE

**FIRMA DEL CLIENTE**  
SIGNATURE

ATTENZIONE:  
La rappresentazione delle finiture è puramente indicativa. Verificare le finiture con le relative cartelle.

Ogni oggetto possiede la peculiarità di essere elaborato secondo principi puramente tradizionali, in modo da garantirne l'assoluta originalità ed unicità. Le eventuali piccole variazioni di colore, tono o venature fra gli articoli sono da considerarsi pregi e non difetti, in quanto garanzia della fattura manuale del prodotto, che fa di ogni oggetto Cielo un pezzo unico ed esclusivo, lontano dall'omologazione industriale. In fase d'ordine si intendono, pertanto, accettate tali tolleranze che non possono dare adito a contestazioni di alcun genere.

Verificare sempre le disponibilità e i tempi di consegna con il commerciale.

ATTENTION:  
The representation of the finishes is merely indicative. Please choose the finishes using the folders.

Every item possesses that particular feature of being processed according to purely traditional principles that guarantee its absolute originality and uniqueness. The small variations in colour, hues or streaks on the items are to be considered as qualities and not defects, since they warranty the handcrafted processing which makes each Cielo item a unique and exclusive piece that cannot be compared to industrial standardization. When making the order, the client implicitly accepts those various features that may give rise to claims of any sort.

Always check the availability and delivery time with the commercial department.

# Catino Tondo

modelli disponibili / available models

## I CATINI collection

### Catino Tondo

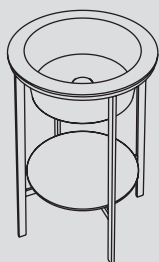

**Catino Tondo 50 con piano**  
Catino Tondo 50 with shelf  
Ø50 x 83 h



## finiture / finishes

### LAVABO IN CERAMICA / CERAMIC WASHBASIN

#### Le Terre di Cielo

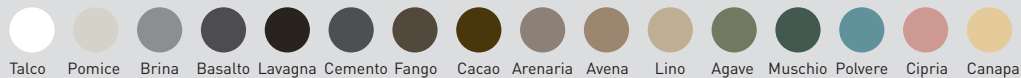

#### Le Acque di Cielo



Bianco Lucido  
Gloss White

CALAT

### STRUTTURA IN ACCIAIO / STEEL FRAMEWORK

#### verniciature / coatings



CASTT



#### Le Acque di Cielo



### PIANO IN CERAMICA O MARMO / CERAMIC OR MARBLE SHELF

#### Le Terre di Cielo



CAPIT /  
CAPITM

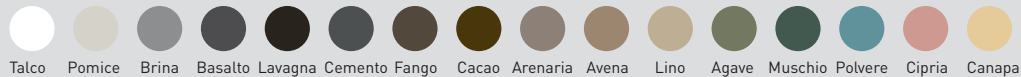

#### Le Acque di Cielo



#### marmo / marble

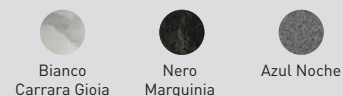

Bianco Lucido  
Gloss White

## note tecniche lavabo / washbasin technical notes



senza foro  
without hole



senza troppopieno  
without overflow



composizione obbligatoria:  
lavabo + struttura + piano  
mandatory combination:  
washbasin + framework + shelf

CLIENTE/client:  ORD. REF.:

QUANTITA'/quantity:  EMAIL:

**INDICARE CON UN SEGNO LE FINITURE SCELTE PER I DIVERSI COMPONENTI**

*INDICATE WITH A TICK, THE CHOOSEN FINISHES FOR ALL THE COMPONENTS*

art. **CASTT**

**FINITURE STRUTTURA**

*FRAMEWORK FINISHES*

verniciature\_coatings

- NM - Nero Matt**
  - BZ - Bronzo Spazzolato**
  - CM - Cemento**
- Le Acque di Cielo
- OL - Oltremare**
  - SM - Smeraldo**
  - AL - Alga**
  - CO - Corallo**
  - NI - Ninfea**
  - AM - Anemone**

art. **CALAT**

**FINITURE LAVABO**

*WASHBASIN SHELF FINISHES*

- Bianco/white - glossy**
- Le Terre di Cielo
- |  |   |
|--|---|
| <input type="checkbox"/> <b>TL - Talco</b>   | <input type="checkbox"/> <b>AN - Arenaria</b> |
| <input type="checkbox"/> <b>PM - Pomice</b>  | <input type="checkbox"/> <b>AV - Avena</b>    |
| <input type="checkbox"/> <b>BR - Brina</b>   | <input type="checkbox"/> <b>LN - Lino</b>     |
| <input type="checkbox"/> <b>BA - Basalto</b> | <input type="checkbox"/> <b>AG - Agave</b>    |
| <input type="checkbox"/> <b>LV - Lavagna</b> | <input type="checkbox"/> <b>MU - Muschio</b>  |
| <input type="checkbox"/> <b>CM - Cemento</b> | <input type="checkbox"/> <b>PL - Polvere</b>  |
| <input type="checkbox"/> <b>FN - Fango</b>   | <input type="checkbox"/> <b>CP - Cipria</b>   |
| <input type="checkbox"/> <b>CA - Cacao</b>   | <input type="checkbox"/> <b>CN - Canapa</b>   |
- Le Acque di Cielo
- |  |  |
|--|--|
| <input type="checkbox"/> <b>OL - Oltremare</b> | <input type="checkbox"/> <b>CO - Corallo</b> |
| <input type="checkbox"/> <b>SM - Smeraldo</b>  | <input type="checkbox"/> <b>NI - Ninfea</b>  |
| <input type="checkbox"/> <b>AL - Alga</b>      | <input type="checkbox"/> <b>AM - Anemone</b> |

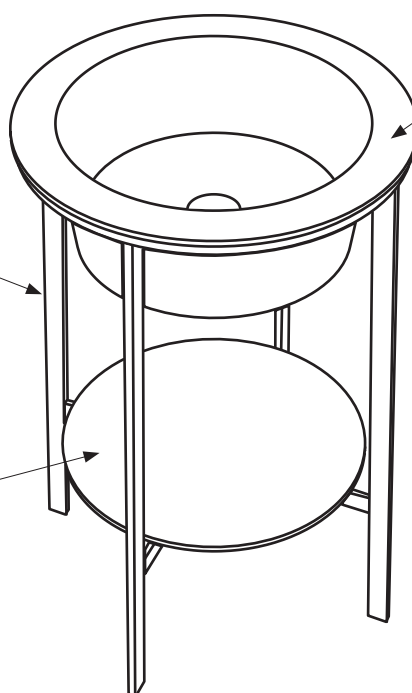

art. **CAPIT**

**FINITURE PIANO IN CERAMICA**

*BOTTOM CERAMIC SHELF FINISHES*

- Bianco/white - glossy**
- Le Terre di Cielo
- |  |   |
|--|---|
| <input type="checkbox"/> <b>TL - Talco</b>   | <input type="checkbox"/> <b>AN - Arenaria</b> |
| <input type="checkbox"/> <b>PM - Pomice</b>  | <input type="checkbox"/> <b>AV - Avena</b>    |
| <input type="checkbox"/> <b>BR - Brina</b>   | <input type="checkbox"/> <b>LN - Lino</b>     |
| <input type="checkbox"/> <b>BA - Basalto</b> | <input type="checkbox"/> <b>AG - Agave</b>    |
| <input type="checkbox"/> <b>LV - Lavagna</b> | <input type="checkbox"/> <b>MU - Muschio</b>  |
| <input type="checkbox"/> <b>CM - Cemento</b> | <input type="checkbox"/> <b>PL - Polvere</b>  |
| <input type="checkbox"/> <b>FN - Fango</b>   | <input type="checkbox"/> <b>CP - Cipria</b>   |
| <input type="checkbox"/> <b>CA - Cacao</b>   | <input type="checkbox"/> <b>CN - Canapa</b>   |
- Le Acque di Cielo
- |  |  |
|--|--|
| <input type="checkbox"/> <b>OL - Oltremare</b> | <input type="checkbox"/> <b>CO - Corallo</b> |
| <input type="checkbox"/> <b>SM - Smeraldo</b>  | <input type="checkbox"/> <b>NI - Ninfea</b>  |
| <input type="checkbox"/> <b>AL - Alga</b>      | <input type="checkbox"/> <b>AM - Anemone</b> |

art. **CAPITM**

**FINITURE PIANO IN MARMO**

*MARBLE BOTTOM SHELF FINISHES*

- MB - Bianco Carrara Gioia**
- MN - Nero Marquinia**
- AZ - Azul Noche**

**DATA**  
DATE

**FIRMA DEL CLIENTE**  
SIGNATURE

ATTENZIONE:  
La rappresentazione delle finiture è puramente indicativa. Verificare le finiture con le relative cartelle.

Ogni oggetto possiede la peculiarità di essere elaborato secondo principi puramente tradizionali, in modo da garantirne l'assoluta originalità ed unicità. Le eventuali piccole variazioni di colore, tono o venature fra gli articoli sono da considerarsi pregi e non difetti, in quanto garanzia della fattura manuale del prodotto, che fa di ogni oggetto Cielo un pezzo unico ed esclusivo, lontano dall'omologazione industriale. In fase d'ordine si intendono, pertanto, accettate tali tolleranze che non possono dare adito a contestazioni di alcun genere.

Verificare sempre le disponibilità e i tempi di consegna con il commerciale.

ATTENTION:  
The representation of the finishes is merely indicative. Please choose the finishes using the folders.

Every item possesses that particular feature of being processed according to purely traditional principles that guarantee its absolute originality and uniqueness. The small variations in colour, hues or streaks on the items are to be considered as qualities and not defects, since they warranty the handcrafted processing which makes each Cielo item a unique and exclusive piece that cannot be compared to industrial standardization. When making the order, the client implicitly accepts those various features that may give rise to claims of any sort.

Always check the availability and delivery time with the commercial department.

# Catino Ovale

modelli disponibili / available models

## I CATINI collection

### Catino Ovale

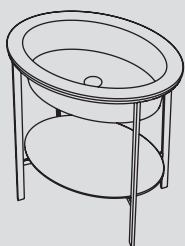

**Catino Ovale 70 con piano**  
Catino Ovale 70 with shelf

70 x 50 x 83 h



finiture / finishes

#### LAVABO IN CERAMICA / CERAMIC WASHBASIN

##### Le Terre di Cielo



CALAO

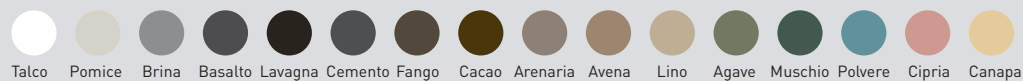

##### Le Acque di Cielo



#### STRUTTURA IN ACCIAIO / STEEL FRAMEWORK

##### verniciature / coatings



CASTO



##### Le Acque di Cielo



#### PIANO IN CERAMICA O MARMO / CERAMIC OR MARBLE SHELF

##### Le Terre di Cielo



CAPIO

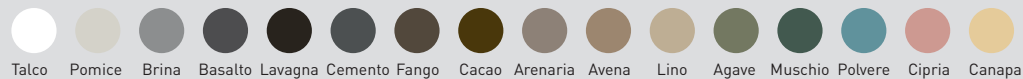

##### Le Acque di Cielo



##### marmo / marble

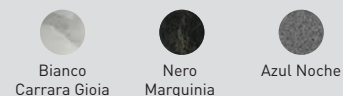

note tecniche lavabo / washbasin technical notes



versione senza foro  
without hole version



senza troppopieno  
without overflow



composizione obbligatoria:  
lavabo + struttura + piano  
mandatory combination:  
washbasin + framework + shelf



# Modulo Ordine Catino Ovale senza foro

## Catino Ovale Order Form without hole

# cielo

CLIENTE/client:  ORD. REF.:

QUANTITA'/quantity:  EMAIL:

INDICARE CON UN SEGNO LE FINITURE SCELTE PER I DIVERSI COMPONENTI

INDICATE WITH A TICK, THE CHOSEN FINISHES FOR ALL THE COMPONENTS

art. **CAPIO**

### FINITURE PIANO IN CERAMICA

BOTTOM CERAMIC SHELF FINISHES

Bianco/white - glossy

Le Terre di Cielo

- |                                    |                                     |
|------------------------------------|-------------------------------------|
| <input type="radio"/> TL - Talco   | <input type="radio"/> AN - Arenaria |
| <input type="radio"/> PM - Pomice  | <input type="radio"/> AV - Avena    |
| <input type="radio"/> BR - Brina   | <input type="radio"/> LN - Lino     |
| <input type="radio"/> BA - Basalto | <input type="radio"/> AG - Agave    |
| <input type="radio"/> LV - Lavagna | <input type="radio"/> MU - Muschio  |
| <input type="radio"/> CM - Cemento | <input type="radio"/> PL - Polvere  |
| <input type="radio"/> FN - Fango   | <input type="radio"/> CP - Cipria   |
| <input type="radio"/> CA - Cacao   | <input type="radio"/> CN - Canapa   |

Le Acque di Cielo

- |                                      |                                    |
|--------------------------------------|------------------------------------|
| <input type="radio"/> OL - Oltremare | <input type="radio"/> CO - Corallo |
| <input type="radio"/> SM - Smeraldo  | <input type="radio"/> NI - Ninfea  |
| <input type="radio"/> AL - Alga      | <input type="radio"/> AM - Anemone |

art. **CAPM**

### FINITURE PIANO IN MARMO

MARBLE BOTTOM SHELF FINISHES

- |   |
|---|
| <input type="radio"/> MB - Bianco Carrara Gioia |
| <input type="radio"/> MN - Nero Marquina        |
| <input type="radio"/> AZ - Azul Noche           |

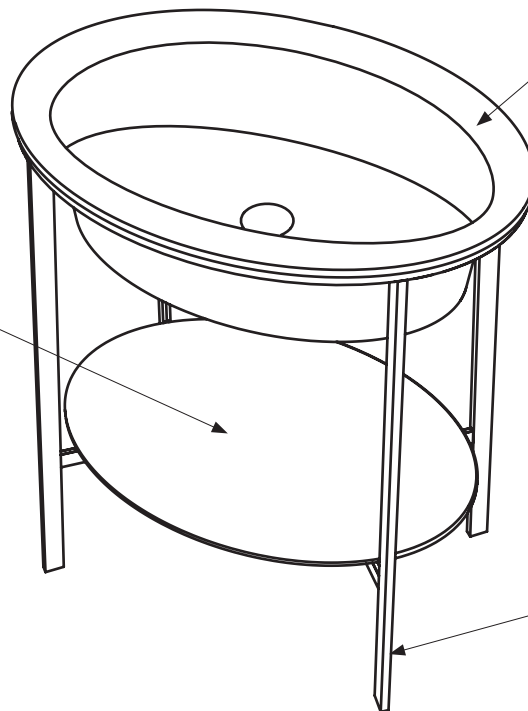

art. **CALAO**

### FINITURE LAVABO

WASHBASIN SHELF FINISHES

Bianco/white - glossy

Le Terre di Cielo

- |                                    |                                     |
|------------------------------------|-------------------------------------|
| <input type="radio"/> TL - Talco   | <input type="radio"/> AN - Arenaria |
| <input type="radio"/> PM - Pomice  | <input type="radio"/> AV - Avena    |
| <input type="radio"/> BR - Brina   | <input type="radio"/> LN - Lino     |
| <input type="radio"/> BA - Basalto | <input type="radio"/> AG - Agave    |
| <input type="radio"/> LV - Lavagna | <input type="radio"/> MU - Muschio  |
| <input type="radio"/> CM - Cemento | <input type="radio"/> PL - Polvere  |
| <input type="radio"/> FN - Fango   | <input type="radio"/> CP - Cipria   |
| <input type="radio"/> CA - Cacao   | <input type="radio"/> CN - Canapa   |

Le Acque di Cielo

- |                                      |                                    |
|--------------------------------------|------------------------------------|
| <input type="radio"/> OL - Oltremare | <input type="radio"/> CO - Corallo |
| <input type="radio"/> SM - Smeraldo  | <input type="radio"/> NI - Ninfea  |
| <input type="radio"/> AL - Alga      | <input type="radio"/> AM - Anemone |

art. **CASTO**

### FINITURE STRUTTURA

FRAMEWORK FINISHES

verniciature\_coatings

- |  |
|--|
| <input type="radio"/> NM - Nero Matt         |
| <input type="radio"/> BZ - Bronzo Spazzolato |
| <input type="radio"/> CM - Cemento           |

Le Acque di Cielo

- |                                      |
|--------------------------------------|
| <input type="radio"/> OL - Oltremare |
| <input type="radio"/> SM - Smeraldo  |
| <input type="radio"/> AL - Alga      |
| <input type="radio"/> CO - Corallo   |
| <input type="radio"/> NI - Ninfea    |
| <input type="radio"/> AM - Anemone   |

DATA  
DATE

FIRMA DEL CLIENTE  
SIGNATURE

ATTENZIONE:  
La rappresentazione delle finiture è puramente indicativa. Verificare le finiture con le relative cartelle.

Ogni oggetto possiede la peculiarità di essere elaborato secondo principi puramente tradizionali, in modo da garantirne l'assoluta originalità ed unicità. Le eventuali piccole variazioni di colore, tono o venature fra gli articoli sono da considerarsi pregi e non difetti, in quanto garanzia della fattura manuale del prodotto, che fa di ogni oggetto Cielo un pezzo unico ed esclusivo, lontano dall'omologazione industriale. In fase d'ordine si intendono, pertanto, accettate tali tolleranze che non possono dare adito a contestazioni di alcun genere.

Verificare sempre le disponibilità e i tempi di consegna con il commerciale.

ATTENTION:  
The representation of the finishes is merely indicative. Please choose the finishes using the folders.

Every item possesses that particular feature of being processed according to purely traditional principles that guarantee its absolute originality and uniqueness. The small variations in colour, hues or streaks on the items are to be considered as qualities and not defects, since they warranty the handcrafted processing which makes each Cielo item a unique and exclusive piece that cannot be compared to industrial standardization. When making the order, the client implicitly accepts those various features that may give rise to claims of any sort.

Always check the availability and delivery time with the commercial department.

# Catino Ovale monoforo

modelli disponibili / available models

## I CATINI

collection

### Catino Ovale

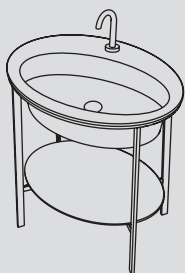

**Catino Ovale 70 monoforo predisposto 3 fori, con piano**

Catino 70 with 1 hole prepared 3 holes, with shelf

70 x 50 x 83 h



finiture / finishes

#### LAVABO IN CERAMICA / CERAMIC WASHBASIN

##### Le Terre di Cielo



CALAOF

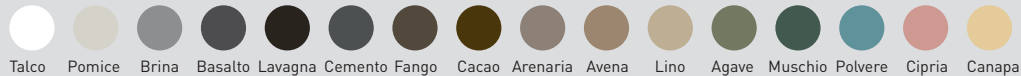

##### Le Acque di Cielo



Bianco Lucido  
Gloss White

#### STRUTTURA IN ACCIAIO / STEEL FRAMEWORK

##### verniciature / coatings



CASTO



##### Le Acque di Cielo



#### PIANO IN CERAMICA O MARMO / CERAMIC OR MARBLE SHELF

##### Le Terre di Cielo



CAPIO

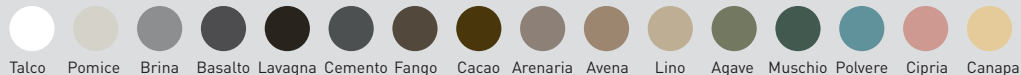

##### Le Acque di Cielo



##### marmo / marble

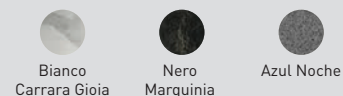

Bianco Lucido  
Gloss White

note tecniche lavabo / washbasin technical notes



versione monoforo predisposto 3 fori  
with 1 hole prepared 3 holes version



senza troppopieno  
without overflow



composizione obbligatoria:  
lavabo + struttura + piano  
mandatory combination:  
washbasin + framework + shelf

# Modulo Ordine Catino Ovale monoforo

## Catino Ovale with one hole Order Form

# cielo

CLIENTE/client:  ORD. REF.:

QUANTITA'/quantity:  EMAIL:

INDICARE CON UN SEGNO LE FINITURE SCELTE PER I DIVERSI COMPONENTI

INDICATE WITH A TICK, THE CHOSEN FINISHES FOR ALL THE COMPONENTS

art. **CAPIO**

### FINITURE PIANO IN CERAMICA

BOTTOM CERAMIC SHELF FINISHES

Bianco/white - glossy

Le Terre di Cielo

- |                                    |                                     |
|------------------------------------|-------------------------------------|
| <input type="radio"/> TL - Talco   | <input type="radio"/> AN - Arenaria |
| <input type="radio"/> PM - Pomice  | <input type="radio"/> AV - Avena    |
| <input type="radio"/> BR - Brina   | <input type="radio"/> LN - Lino     |
| <input type="radio"/> BA - Basalto | <input type="radio"/> AG - Agave    |
| <input type="radio"/> LV - Lavagna | <input type="radio"/> MU - Muschio  |
| <input type="radio"/> CM - Cemento | <input type="radio"/> PL - Polvere  |
| <input type="radio"/> FN - Fango   | <input type="radio"/> CP - Cipria   |
| <input type="radio"/> CA - Cacao   | <input type="radio"/> CN - Canapa   |

Le Acque di Cielo

- |                                      |                                    |
|--------------------------------------|------------------------------------|
| <input type="radio"/> OL - Oltremare | <input type="radio"/> CO - Corallo |
| <input type="radio"/> SM - Smeraldo  | <input type="radio"/> NI - Ninfea  |
| <input type="radio"/> AL - Alga      | <input type="radio"/> AM - Anemone |

art. **CAPION**

### FINITURE PIANO IN MARMO

MARBLE BOTTOM SHELF FINISHES

- |   |
|---|
| <input type="radio"/> MB - Bianco Carrara Gioia |
| <input type="radio"/> MN - Nero Marquina        |
| <input type="radio"/> AZ - Azul Noche           |

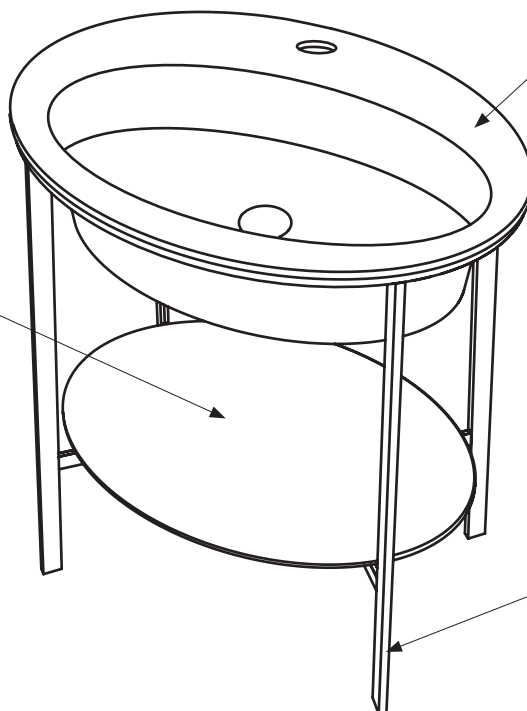

art. **CALAOF**

### FINITURE LAVABO

WASHBASIN SHELF FINISHES

Bianco/white - glossy

Le Terre di Cielo

- |                                    |                                     |
|------------------------------------|-------------------------------------|
| <input type="radio"/> TL - Talco   | <input type="radio"/> AN - Arenaria |
| <input type="radio"/> PM - Pomice  | <input type="radio"/> AV - Avena    |
| <input type="radio"/> BR - Brina   | <input type="radio"/> LN - Lino     |
| <input type="radio"/> BA - Basalto | <input type="radio"/> AG - Agave    |
| <input type="radio"/> LV - Lavagna | <input type="radio"/> MU - Muschio  |
| <input type="radio"/> CM - Cemento | <input type="radio"/> PL - Polvere  |
| <input type="radio"/> FN - Fango   | <input type="radio"/> CP - Cipria   |
| <input type="radio"/> CA - Cacao   | <input type="radio"/> CN - Canapa   |

Le Acque di Cielo

- |                                      |                                    |
|--------------------------------------|------------------------------------|
| <input type="radio"/> OL - Oltremare | <input type="radio"/> CO - Corallo |
| <input type="radio"/> SM - Smeraldo  | <input type="radio"/> NI - Ninfea  |
| <input type="radio"/> AL - Alga      | <input type="radio"/> AM - Anemone |

art. **CASTO**

### FINITURE STRUTTURA

FRAMEWORK FINISHES

verniciature\_coatings

- |  |
|--|
| <input type="radio"/> NM - Nero Matt         |
| <input type="radio"/> BZ - Bronzo Spazzolato |
| <input type="radio"/> CM - Cemento           |

Le Acque di Cielo

- |                                      |
|--------------------------------------|
| <input type="radio"/> OL - Oltremare |
| <input type="radio"/> SM - Smeraldo  |
| <input type="radio"/> AL - Alga      |
| <input type="radio"/> CO - Corallo   |
| <input type="radio"/> NI - Ninfea    |
| <input type="radio"/> AM - Anemone   |

**N.B.**  
**Il lavabo è monoforo predisposto 3 fori, su richiesta può essere prodotto senza foro.**  
**Gli elementi di fissaggio sono sempre neri in tutte le versioni.**

**N.B.**  
*The washbasin has 1 hole prepared 3 holes ; mayay be made without holes upon request.*  
*The fixing elements are always black in all versions.*

DATA  
DATE

FIRMA DEL CLIENTE  
SIGNATURE

ATTENZIONE:  
La rappresentazione delle finiture è puramente indicativa. Verificare le finiture con le relative cartelle.

Ogni oggetto possiede la peculiarità di essere elaborato secondo principi puramente tradizionali, in modo da garantirne l'assoluta originalità ed unicità. Le eventuali piccole variazioni di colore, tono o venature fra gli articoli sono da considerarsi pregi e non difetti, in quanto garanzia della fattura manuale del prodotto, che fa di ogni oggetto Cielo un pezzo unico ed esclusivo, lontano dall'omologazione industriale. In fase d'ordine si intendono, pertanto, accettate tali tolleranze che non possono dare adito a contestazioni di alcun genere.

Verificare sempre le disponibilità e i tempi di consegna con il commerciale.

ATTENTION:  
The representation of the finishes is merely indicative. Please choose the finishes using the folders.

Every item possesses that particular feature of being processed according to purely traditional principles that guarantee its absolute originality and uniqueness. The small variations in colour, hues or streaks on the items are to be considered as qualities and not defects, since they warranty the handcrafted processing which makes each Cielo item a unique and exclusive piece that cannot be compared to industrial standardization. When making the order, the client implicitly accepts those various features that may give rise to claims of any sort.

Always check the availability and delivery time with the commercial department.

# Catino Ovale



modelli disponibili / available models

**I CATINI**  
collection

**Catino Ovale**

**Catino Ovale 70 con cassetto**  
Catino Ovale 70 with drawer

**70 x 50 x 83 h**

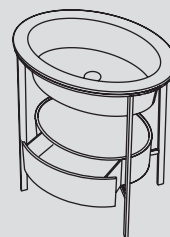

**finiture / finishes**

**LAVABO IN CERAMICA / CERAMIC WASHBASIN**

**Le Terre di Cielo**



**Le Acque di Cielo**



**CALAO**

**STRUTTURA IN ACCIAIO / STEEL FRAMEWORK**

**verniciature / coatings**



**CASTO**

**CASSETTO IN LEGNO / WOODEN DRAWER**

**Le Terre di Cielo laccature / lacquers**



**essenze / wooden finishes**

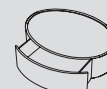
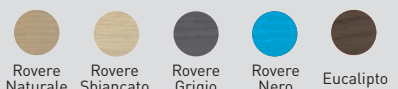

**CACOL\CACOE**

**note tecniche lavabo / washbasin technical notes**



**versione senza foro**  
without hole version



**senza troppopieno**  
without overflow



**composizione obbligatoria:**  
lavabo + struttura + cassetto  
mandatory combination:  
washbasin + framework + drawer

# Modulo Ordine Catino Ovale con Cassetto, senza foro

## Catino Ovale with drawer Order Form without hole

# cielo

CLIENTE/client:  ORD. REF.:

QUANTITA'/quantity:  EMAIL:

INDICARE CON UN SEGNO LE FINITURE SCELTE PER I DIVERSI COMPONENTI

INDICATE WITH A TICK, THE CHOSEN FINISHES FOR ALL THE COMPONENTS

art. **CASTO**

### FINITURE STRUTTURA

FRAMEWORK FINISHES

verniciature\_coatings

- NM - Nero Matt**
- BZ - Bronzo Spazzolato**
- CM - Cemento**

Le Acque di Cielo

- OL - Oltremare**
- SM - Smeraldo**
- AL - Alga**
- CO - Corallo**
- NI - Ninfea**
- AM - Anemone**

art. **CALAO**

### FINITURE LAVABO

WASHBASIN SHELF FINISHES

- Bianco/white - glossy**

Le Terre di Cielo

- |  |   |
|--|---|
| <input type="checkbox"/> <b>TL - Talco</b>   | <input type="checkbox"/> <b>AN - Arenaria</b> |
| <input type="checkbox"/> <b>PM - Pomice</b>  | <input type="checkbox"/> <b>AV - Avena</b>    |
| <input type="checkbox"/> <b>BR - Brina</b>   | <input type="checkbox"/> <b>LN - Lino</b>     |
| <input type="checkbox"/> <b>BA - Basalto</b> | <input type="checkbox"/> <b>AG - Agave</b>    |
| <input type="checkbox"/> <b>LV - Lavagna</b> | <input type="checkbox"/> <b>MU - Muschio</b>  |
| <input type="checkbox"/> <b>CM - Cemento</b> | <input type="checkbox"/> <b>PL - Polvere</b>  |
| <input type="checkbox"/> <b>FN - Fango</b>   | <input type="checkbox"/> <b>CP - Cipria</b>   |
| <input type="checkbox"/> <b>CA - Cacao</b>   | <input type="checkbox"/> <b>CN - Canapa</b>   |

Le Acque di Cielo

- |  |  |
|--|--|
| <input type="checkbox"/> <b>OL - Oltremare</b> | <input type="checkbox"/> <b>CO - Corallo</b> |
| <input type="checkbox"/> <b>SM - Smeraldo</b>  | <input type="checkbox"/> <b>NI - Ninfea</b>  |
| <input type="checkbox"/> <b>AL - Alga</b>      | <input type="checkbox"/> <b>AM - Anemone</b> |

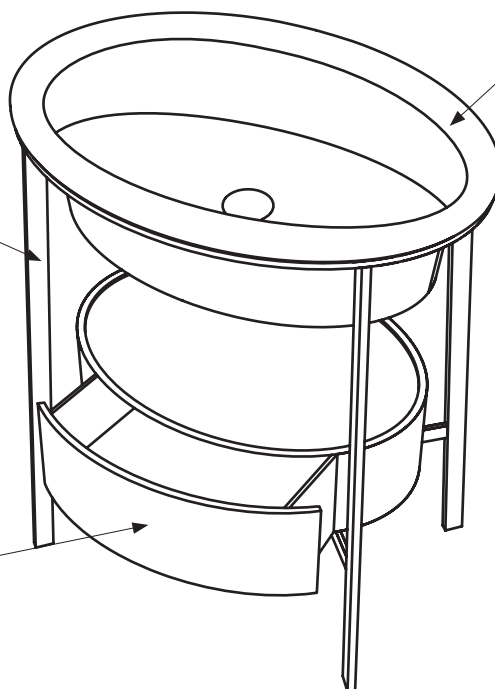

art. **CACOL** / art. **CACOE**

### FINITURE CASSETTO IN LEGNO

WOODEN DRAWER FINISHES

laccature/laquerings

- |   |  |
|---|--|
| <input type="checkbox"/> <b>TL - Talco</b>    | <input type="checkbox"/> <b>AV - Avena</b>   |
| <input type="checkbox"/> <b>PM - Pomice</b>   | <input type="checkbox"/> <b>CM - Cemento</b> |
| <input type="checkbox"/> <b>BR - Brina</b>    | <input type="checkbox"/> <b>BA - Basalto</b> |
| <input type="checkbox"/> <b>AN - Arenaria</b> | <input type="checkbox"/> <b>MU - Muschio</b> |

essenze legno/wood essences

- |   |  |
|---|--|
| <input type="checkbox"/> <b>RG - Rovere Grigio</b>    | <input type="checkbox"/> <b>RO - Rovere Nero</b> |
| <input type="checkbox"/> <b>RS - Rovere Sbiancato</b> | <input type="checkbox"/> <b>EU - Eucalipto</b>   |
| <input type="checkbox"/> <b>RN - Rovere Naturale</b>  |  |

**DATA**

DATE

**FIRMA DEL CLIENTE**

SIGNATURE

ATTENZIONE:  
La rappresentazione delle finiture è puramente indicativa. Verificare le finiture con le relative cartelle.

Ogni oggetto possiede la peculiarità di essere elaborato secondo principi puramente tradizionali, in modo da garantirne l'assoluta originalità ed unicità. Le eventuali piccole variazioni di colore, tono o venature fra gli articoli sono da considerarsi pregi e non difetti, in quanto garanzia della fattura manuale del prodotto, che fa di ogni oggetto Cielo un pezzo unico ed esclusivo, lontano dall'omologazione industriale. In fase d'ordine si intendono, pertanto, accettate tali tolleranze che non possono dare adito a contestazioni di alcun genere.

Verificare sempre le disponibilità e i tempi di consegna con il commerciale.

ATTENTION:  
The representation of the finishes is merely indicative. Please choose the finishes using the folders.

Every item possesses that particular feature of being processed according to purely traditional principles that guarantee its absolute originality and uniqueness. The small variations in colour, hues or streaks on the items are to be considered as qualities and not defects, since they warranty the handcrafted processing which makes each Cielo item a unique and exclusive piece that cannot be compared to industrial standardization. When making the order, the client implicitly accepts those various features that may give rise to claims of any sort.

Always check the availability and delivery time with the commercial department.

# Catino Ovale monoforo



modelli disponibili / available models

**I CATINI**  
collection

## Catino Ovale

**Catino Ovale 70 monoforo**  
predisposto 3 fori, con  
cassetto

Catino 70 with 1 hole  
prepared 3 holes, with  
drawer

70 x 50 x 83 h

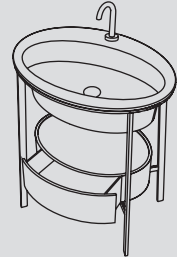

finiture / finishes

LAVABO IN CERAMICA / CERAMIC WASHBASIN

Le Terre di Cielo



Le Acque di Cielo



CALAOF

STRUTTURA IN ACCIAIO / STEEL FRAMEWORK

verniciature / coatings



CASTO

CASSETTO IN LEGNO / WOODEN DRAWER

Le Terre di Cielo laccature / lacquers

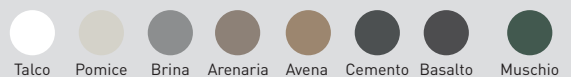

essenze / wooden finishes

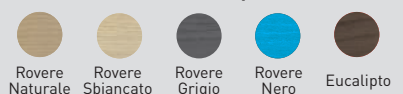

CACOL\CACOE

note tecniche lavabo / washbasin technical notes



versione monoforo predisposto 3 fori  
with 1 hole prepared 3 holes version



senza troppopieno  
without overflow



composizione obbligatoria:  
lavabo + struttura + cassetto  
mandatory combination:  
washbasin + framework + drawer



# Modulo Ordine Catino Ovale monoforo con Cassetto

## Catino Ovale with one hole, with drawer Order Form

# cielo

CLIENTE/client:  ORD. REF.:

QUANTITA'/quantity:  EMAIL:

INDICARE CON UN SEGNO LE FINITURE SCELTE PER I DIVERSI COMPONENTI

INDICATE WITH A TICK, THE CHOSEN FINISHES FOR ALL THE COMPONENTS

art. **CASTO**

### FINITURE STRUTTURA

FRAMEWORK FINISHES

verniciature\_coatings

- NM - Nero Matt
- BZ - Bronzo Spazzolato
- CM - Cemento

Le Acque di Cielo

- OL - Oltremare
- SM - Smeraldo
- AL - Alga
- CO - Corallo
- NI - Ninfea
- AM - Anemone

art. **CALAOF**

### FINITURE LAVABO

WASHBASIN SHELF FINISHES

- Bianco/white - glossy

Le Terre di Cielo

- |                                       |  |
|---------------------------------------|--|
| <input type="checkbox"/> TL - Talco   | <input type="checkbox"/> AN - Arenaria |
| <input type="checkbox"/> PM - Pomice  | <input type="checkbox"/> AV - Avena    |
| <input type="checkbox"/> BR - Brina   | <input type="checkbox"/> LN - Lino     |
| <input type="checkbox"/> BA - Basalto | <input type="checkbox"/> AG - Agave    |
| <input type="checkbox"/> LV - Lavagna | <input type="checkbox"/> MU - Muschio  |
| <input type="checkbox"/> CM - Cemento | <input type="checkbox"/> PL - Polvere  |
| <input type="checkbox"/> FN - Fango   | <input type="checkbox"/> CP - Cipria   |
| <input type="checkbox"/> CA - Cacao   | <input type="checkbox"/> CN - Canapa   |

Le Acque di Cielo

- |   |                                       |
|---|---------------------------------------|
| <input type="checkbox"/> OL - Oltremare | <input type="checkbox"/> CO - Corallo |
| <input type="checkbox"/> SM - Smeraldo  | <input type="checkbox"/> NI - Ninfea  |
| <input type="checkbox"/> AL - Alga      | <input type="checkbox"/> AM - Anemone |

art. **CACOL** / art. **CACOE**

### FINITURE CASSETTO IN LEGNO

WOODEN DRAWER FINISHES

laccature/laquerings

- |  |                                       |
|--|---------------------------------------|
| <input type="checkbox"/> TL - Talco    | <input type="checkbox"/> AV - Avena   |
| <input type="checkbox"/> PM - Pomice   | <input type="checkbox"/> CM - Cemento |
| <input type="checkbox"/> BR - Brina    | <input type="checkbox"/> BA - Basalto |
| <input type="checkbox"/> AN - Arenaria | <input type="checkbox"/> MU - Muschio |

essenze legno/wood essences

- |  |   |
|--|---|
| <input type="checkbox"/> RG - Rovere Grigio    | <input type="checkbox"/> RO - Rovere Nero |
| <input type="checkbox"/> RS - Rovere Sbiancato | <input type="checkbox"/> EU - Eucalipto   |
| <input type="checkbox"/> RN - Rovere Naturale  |   |

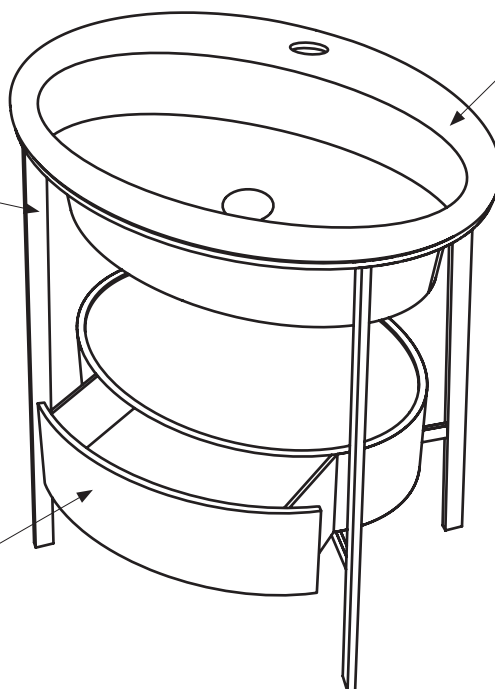

**N.B.**  
**Il lavabo è monoforo predisposto 3 fori, su richiesta può essere prodotto senza foro.**  
**Gli elementi di fissaggio sono sempre neri in tutte le versioni.**

**N.B.**  
*The washbasin has 1 hole prepared 3 holes ; mayay be made without holes upon request.*  
*The fixing elements are always black in all versions.*

DATA  
DATE

FIRMA DEL CLIENTE  
SIGNATURE

ATTENZIONE:  
La rappresentazione delle finiture è puramente indicativa. Verificare le finiture con le relative cartelle.

Ogni oggetto possiede la peculiarità di essere elaborato secondo principi puramente tradizionali, in modo da garantirne l'assoluta originalità ed unicità. Le eventuali piccole variazioni di colore, tono o venature fra gli articoli sono da considerarsi pregi e non difetti, in quanto garanzia della fattura manuale del prodotto, che fa di ogni oggetto Cielo un pezzo unico ed esclusivo, lontano dall'omologazione industriale. In fase d'ordine si intendono, pertanto, accettate tali tolleranze che non possono dare adito a contestazioni di alcun genere.

Verificare sempre le disponibilità e i tempi di consegna con il commerciale.

ATTENTION:  
The representation of the finishes is merely indicative. Please choose the finishes using the folders.

Every item possesses that particular feature of being processed according to purely traditional principles that guarantee its absolute originality and uniqueness. The small variations in colour, hues or streaks on the items are to be considered as qualities and not defects, since they warranty the handcrafted processing which makes each Cielo item a unique and exclusive piece that cannot be compared to industrial standardization. When making the order, the client implicitly accepts those various features that may give rise to claims of any sort.

Always check the availability and delivery time with the commercial department.



# Catino Doppio

modelli disponibili / available models

## I CATINI

collection

### Catino Doppio

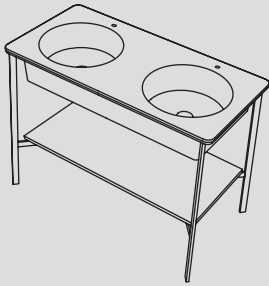

Catino Doppio 110 con piano  
Catino Doppio 110 with shelf

110 x 58,5 x 83 h



finiture / finishes

#### LAVABO IN CERAMICA / CERAMIC WASHBASIN

##### Le Terre di Cielo

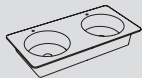

CALAD



##### Le Acque di Cielo



#### STRUTTURA IN ACCIAIO / STEEL FRAMEWORK

##### verniciature / coatings

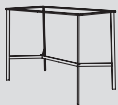

CASTD



##### Le Acque di Cielo



#### PIANO IN LEGNO O MARMO / WOODEN OR MARBLE SHELF



CAPIDL  
CAPIDE

##### Le Terre di Cielo



##### marmo / marble

CAPIDM

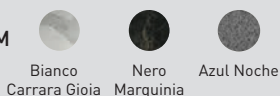

##### laccature / lacquers

##### essenze / wooden finishes

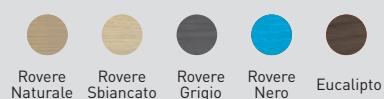

note tecniche lavabo / washbasin technical notes

2 fori predisposto 6 fori  
with 2 holes prepared 6 holes

senza foro su richiesta  
no tap hole on request

senza troppopieno  
without overflow

composizione obbligatoria:  
lavabo + struttura + piano  
mandatory combination:  
washbasin + framework + shelf

# Modulo Ordine Catino Doppio con piano

## Catino Doppio with shelf Order Form

# cielo

CLIENTE/client:  ORD. REF.:

QUANTITA'/quantity:  EMAIL:

INDICARE CON UN SEGNO LE FINITURE SCELTE PER I DIVERSI COMPONENTI

INDICATE WITH A TICK, THE CHOSEN FINISHES FOR ALL THE COMPONENTS

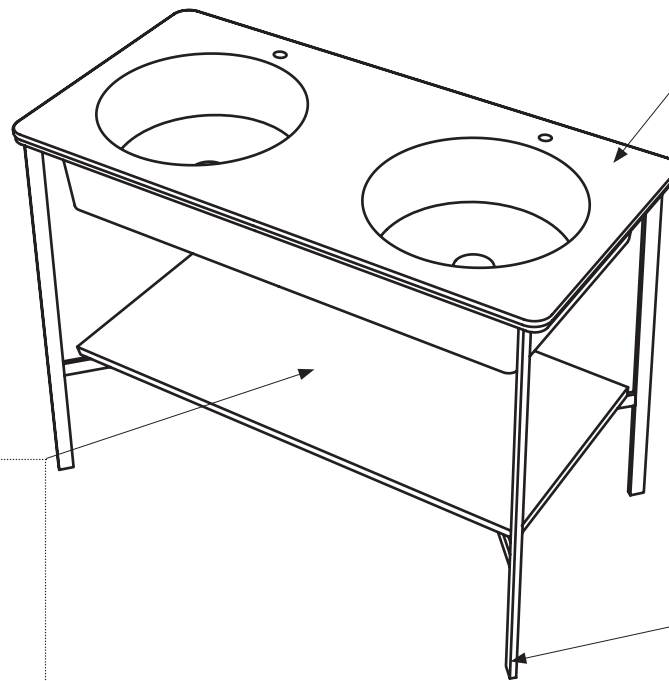

art. **CAPIDL** / art. **CAPIDE**

### FINITURE PIANO IN LEGNO

BOTTOM WOODEN SHELF FINISHES

laccature/laquerings (art. CAPIDL)

- |                                     |                                    |
|-------------------------------------|------------------------------------|
| <input type="radio"/> TL - Talco    | <input type="radio"/> AV - Avena   |
| <input type="radio"/> PM - Pomice   | <input type="radio"/> CM - Cemento |
| <input type="radio"/> BR - Brina    | <input type="radio"/> BA - Basalto |
| <input type="radio"/> AN - Arenaria | <input type="radio"/> MU - Muschio |

essenze legno/wood essences (art. CAPIDE)

- |   |  |
|---|--|
| <input type="radio"/> RG - Rovere Grigio    | <input type="radio"/> RO - Rovere Nero |
| <input type="radio"/> RS - Rovere Sbiancato | <input type="radio"/> EU - Eucalipto   |
| <input type="radio"/> RN - Rovere Naturale  |  |

art. **CAPIDM**

### FINITURE PIANO IN MARMO

MARBLE BOTTOM SHELF FINISHES

- |   |
|---|
| <input type="radio"/> MB - Bianco Carrara Gioia |
| <input type="radio"/> MN - Nero Marquina        |
| <input type="radio"/> AZ - Azul Noche           |

art. **CALAD \ CALADSF**

### FINITURE LAVABO

WASHBASIN SHELF FINISHES

- Bianco/white - glossy

Le Terre di Cielo

- |                                    |                                     |
|------------------------------------|-------------------------------------|
| <input type="radio"/> TL - Talco   | <input type="radio"/> AN - Arenaria |
| <input type="radio"/> PM - Pomice  | <input type="radio"/> AV - Avena    |
| <input type="radio"/> BR - Brina   | <input type="radio"/> LN - Lino     |
| <input type="radio"/> BA - Basalto | <input type="radio"/> AG - Agave    |
| <input type="radio"/> LV - Lavagna | <input type="radio"/> MU - Muschio  |
| <input type="radio"/> CM - Cemento | <input type="radio"/> PL - Polvere  |
| <input type="radio"/> FN - Fango   | <input type="radio"/> CP - Cipria   |
| <input type="radio"/> CA - Cacao   | <input type="radio"/> CN - Canapa   |

Le Acque di Cielo

- |                                      |                                    |
|--------------------------------------|------------------------------------|
| <input type="radio"/> OL - Oltremare | <input type="radio"/> CO - Corallo |
| <input type="radio"/> SM - Smeraldo  | <input type="radio"/> NI - Ninfea  |
| <input type="radio"/> AL - Alga      | <input type="radio"/> AM - Anemone |

art. **CASTD**

### FINITURE STRUTTURA

FRAMEWORK FINISHES

verniciature\_coatings

- |  |
|--|
| <input type="radio"/> NM - Nero Matt         |
| <input type="radio"/> BZ - Bronzo Spazzolato |
| <input type="radio"/> CM - Cemento           |

Le Acque di Cielo

- |                                      |
|--------------------------------------|
| <input type="radio"/> OL - Oltremare |
| <input type="radio"/> SM - Smeraldo  |
| <input type="radio"/> AL - Alga      |
| <input type="radio"/> CO - Corallo   |
| <input type="radio"/> NI - Ninfea    |
| <input type="radio"/> AM - Anemone   |

**N.B. Il lavabo ha 2 fori predisposto 6 fori, su richiesta può essere prodotto senza foro**

*N.B. The washbasin has 2 hole prepared 6 holes ; may be made without holes upon request*

DATA  
DATE

FIRMA DEL CLIENTE  
SIGNATURE

ATTENZIONE:  
La rappresentazione delle finiture è puramente indicativa. Verificare le finiture con le relative cartelle.

Ogni oggetto possiede la peculiarità di essere elaborato secondo principi puramente tradizionali, in modo da garantirne l'assoluta originalità ed unicità. Le eventuali piccole variazioni di colore, tono o venature fra gli articoli sono da considerarsi pregi e non difetti, in quanto garanzia della fattura manuale del prodotto, che fa di ogni oggetto Cielo un pezzo unico ed esclusivo, lontano dall'omologazione industriale. In fase d'ordine si intendono, pertanto, accettate tali tolleranze che non possono dare adito a contestazioni di alcun genere.

Verificare sempre le disponibilità e i tempi di consegna con il commerciale.

ATTENTION:  
The representation of the finishes is merely indicative. Please choose the finishes using the folders.

Every item possesses that particular feature of being processed according to purely traditional principles that guarantee its absolute originality and uniqueness. The small variations in colour, hues or streaks on the items are to be considered as qualities and not defects, since they warranty the handcrafted processing which makes each Cielo item a unique and exclusive piece that cannot be compared to industrial standardization. When making the order, the client implicitly accepts those various features that may give rise to claims of any sort.

Always check the availability and delivery time with the commercial department.

# Catino Doppio



modelli disponibili / available models

**I CATINI**  
collection

**Catino Doppio**

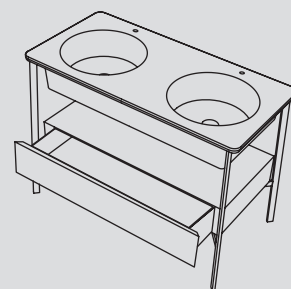

**Catino Doppio 110 con cassetto**  
Catino Doppio 110 with drawer

110 x 58,5 x 83 h

finiture / finishes

LAVABO IN CERAMICA / CERAMIC WASHBASIN

Le Terre di Cielo



Le Acque di Cielo

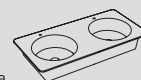

CALAD

STRUTTURA IN ACCIAIO / STEEL FRAMEWORK

verniciature / coatings



Le Acque di Cielo



CASTD

CASSETTO IN LEGNO / WOODEN DRAWER

Le Terre di Cielo laccature / lacquers

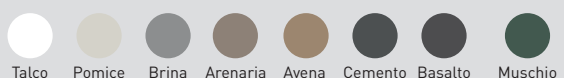

essenze / wooden finishes

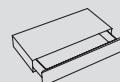
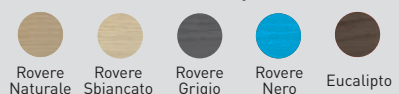

CACDL  
CACDE

note tecniche lavabo / washbasin technical notes

2 fori predisposto 6 fori  
with 2 holes prepared 6 holes

senza foro su richiesta  
no tap hole on request

senza troppopieno  
without overflow

composizione obbligatoria:  
lavabo + struttura + cassetto  
mandatory combination:  
washbasin + framework + drawer

# Modulo Ordine Catino Doppio con Cassetto

## Catino Doppio Order Form

# cielo

CLIENTE/client:  ORD. REF.:

QUANTITA'/quantity:  EMAIL:

**INDICARE CON UN SEGNO LE FINITURE SCELTE PER I DIVERSI COMPONENTI**

**INDICATE WITH A TICK, THE CHOSEN FINISHES FOR ALL THE COMPONENTS**

art. **CASTD**

### FINITURE STRUTTURA

FRAMEWORK FINISHES

verniciature\_coatings

- NM - Nero Matt
- BZ - Bronzo Spazzolato
- CM - Cemento

Le Acque di Cielo

- OL - Oltremare
- SM - Smeraldo
- AL - Alga
- CO - Corallo
- NI - Ninfea
- AM - Anemone

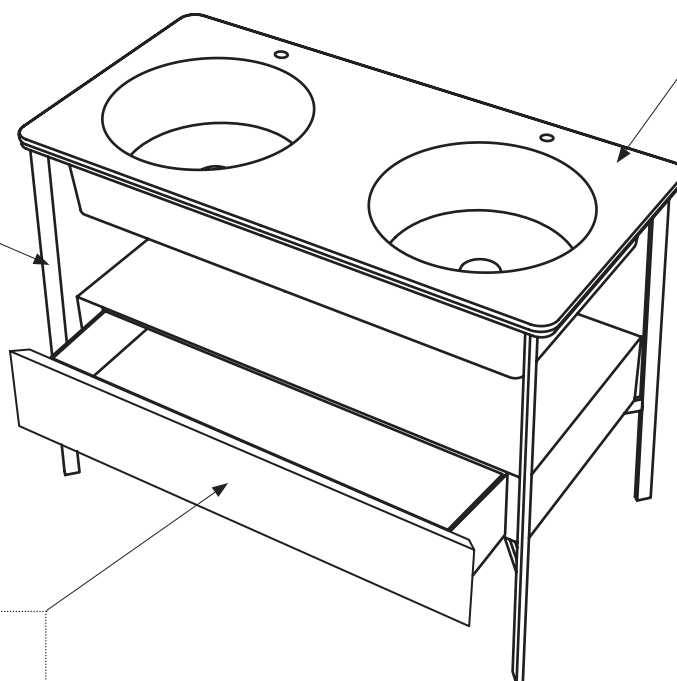

art. **CALAD \ CALADSF**

### FINITURE LAVABO

WASHBASIN SHELF FINISHES

- Bianco/white - glossy

Le Terre di Cielo

- |                                    |                                     |
|------------------------------------|-------------------------------------|
| <input type="radio"/> TL - Talco   | <input type="radio"/> AN - Arenaria |
| <input type="radio"/> PM - Pomice  | <input type="radio"/> AV - Avena    |
| <input type="radio"/> BR - Brina   | <input type="radio"/> LN - Lino     |
| <input type="radio"/> BA - Basalto | <input type="radio"/> AG - Agave    |
| <input type="radio"/> LV - Lavagna | <input type="radio"/> MU - Muschio  |
| <input type="radio"/> CM - Cemento | <input type="radio"/> PL - Polvere  |
| <input type="radio"/> FN - Fango   | <input type="radio"/> CP - Cipria   |
| <input type="radio"/> CA - Cacao   | <input type="radio"/> CN - Canapa   |

Le Acque di Cielo

- |                                      |                                    |
|--------------------------------------|------------------------------------|
| <input type="radio"/> OL - Oltremare | <input type="radio"/> CO - Corallo |
| <input type="radio"/> SM - Smeraldo  | <input type="radio"/> NI - Ninfea  |
| <input type="radio"/> AL - Alga      | <input type="radio"/> AM - Anemone |

art. **CACDL / art. CACDE**

### FINITURE CASSETTO IN LEGNO

BOTTOM WOODEN DRAWER FINISHES

laccature/laquerings (art. CACDL)

- |                                     |                                    |
|-------------------------------------|------------------------------------|
| <input type="radio"/> TL - Talco    | <input type="radio"/> AV - Avena   |
| <input type="radio"/> PM - Pomice   | <input type="radio"/> CM - Cemento |
| <input type="radio"/> BR - Brina    | <input type="radio"/> BA - Basalto |
| <input type="radio"/> AN - Arenaria | <input type="radio"/> MU - Muschio |

essenze legno/wood essences (art. CACDE)

- |   |  |
|---|--|
| <input type="radio"/> RG - Rovere Grigio    | <input type="radio"/> RO - Rovere Nero |
| <input type="radio"/> RS - Rovere Sbiancato | <input type="radio"/> EU - Eucalipto   |
| <input type="radio"/> RN - Rovere Naturale  |  |

**N.B. Il lavabo ha 2 fori predisposto 6 fori, su richiesta può essere prodotto senza foro**

*N.B. The washbasin has 2 hole prepared 6 holes ; may be made without holes upon request*

**DATA**

DATE

**FIRMA DEL CLIENTE**

SIGNATURE

ATTENZIONE:

La rappresentazione delle finiture è puramente indicativa. Verificare le finiture con le relative cartelle.

Ogni oggetto possiede la peculiarità di essere elaborato secondo principi puramente tradizionali, in modo da garantirne l'assoluta originalità ed unicità. Le eventuali piccole variazioni di colore, tono o venature fra gli articoli sono da considerarsi pregi e non difetti, in quanto garanzia della fattura manuale del prodotto, che fa di ogni oggetto Cielo un pezzo unico ed esclusivo, lontano dall'omologazione industriale. In fase d'ordine si intendono, pertanto, accettate tali tolleranze che non possono dare adito a contestazioni di alcun genere.

Verificare sempre le disponibilità e i tempi di consegna con il commerciale.

ATTENTION:

The representation of the finishes is merely indicative. Please choose the finishes using the folders.

Every item possesses that particular feature of being processed according to purely traditional principles that guarantee its absolute originality and uniqueness. The small variations in colour, hues or streaks on the items are to be considered as qualities and not defects, since they warranty the handcrafted processing which makes each Cielo item a unique and exclusive piece that cannot be compared to industrial standardization. When making the order, the client implicitly accepts those various features that may give rise to claims of any sort.

Always check the availability and delivery time with the commercial department.

# Catino Rettangolare

modelli disponibili / available models

## I CATINI

collection

### Catino Rettangolare

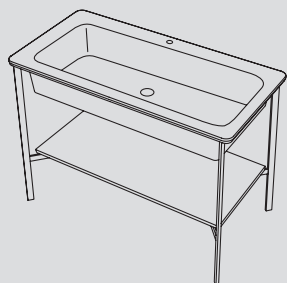

Catino Rettangolare con piano  
/ with shelf

110 x 58,5 x 83 h



finiture / finishes

#### LAVABO IN CERAMICA / CERAMIC WASHBASIN

##### Le Terre di Cielo

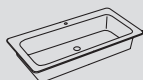

CALAR

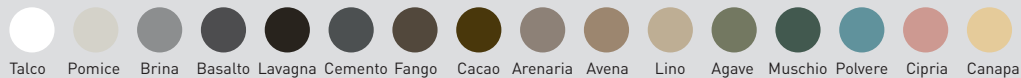

##### Le Acque di Cielo



#### STRUTTURA IN ACCIAIO / STEEL FRAMEWORK



CASTD

##### verniciature / coatings



##### Le Acque di Cielo



#### PIANO IN LEGNO O MARMO / WOODEN OR MARBLE SHELF



CAPIDL/  
CAPIDE

##### Le Terre di Cielo



##### marmo / marble

CAPIDM

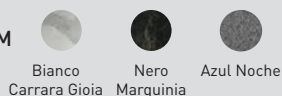

##### laccature / lacquers

##### essenze / wooden finishes

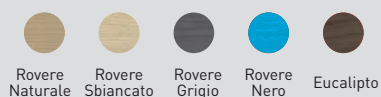

note tecniche lavabo / washbasin technical notes

1 foro predisposto 5 fori  
with 1 holes prepared 5 holes

senza foro su richiesta  
no tap hole on request

senza troppopieno  
without overflow

composizione obbligatoria:  
lavabo + struttura + piano  
mandatory combination:  
washbasin + framework + shelf

CLIENTE/client:  ORD. REF.:

QUANTITA'/quantity:  EMAIL:

**INDICARE CON UN SEGNO LE FINITURE SCELTE PER I DIVERSI COMPONENTI**

**INDICATE WITH A TICK, THE CHOSEN FINISHES FOR ALL THE COMPONENTS**

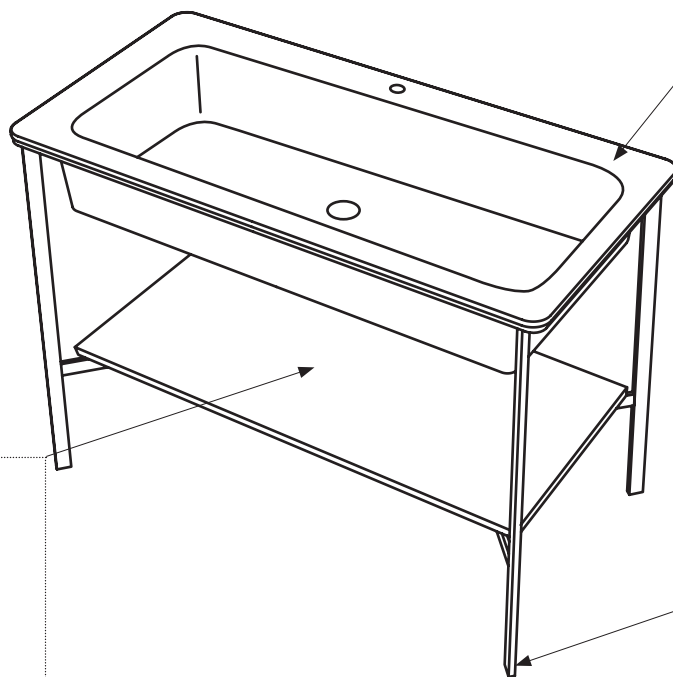

art. **CALAR \ CALARSF**

**FINITURE LAVABO**

WASHBASIN SHELF FINISHES

Bianco/white - glossy

Le Terre di Cielo

- |                                    |                                     |
|------------------------------------|-------------------------------------|
| <input type="radio"/> TL - Talco   | <input type="radio"/> AN - Arenaria |
| <input type="radio"/> PM - Pomice  | <input type="radio"/> AV - Avena    |
| <input type="radio"/> BR - Brina   | <input type="radio"/> LN - Lino     |
| <input type="radio"/> BA - Basalto | <input type="radio"/> AG - Agave    |
| <input type="radio"/> LV - Lavagna | <input type="radio"/> MU - Muschio  |
| <input type="radio"/> CM - Cemento | <input type="radio"/> PL - Polvere  |
| <input type="radio"/> FN - Fango   | <input type="radio"/> CP - Cipria   |
| <input type="radio"/> CA - Cacao   | <input type="radio"/> CN - Canapa   |

Le Acque di Cielo

- |                                      |                                    |
|--------------------------------------|------------------------------------|
| <input type="radio"/> OL - Oltremare | <input type="radio"/> CO - Corallo |
| <input type="radio"/> SM - Smeraldo  | <input type="radio"/> NI - Ninfea  |
| <input type="radio"/> AL - Alga      | <input type="radio"/> AM - Anemone |

art. **CAPIDL / art. CAPIDE**

**FINITURE PIANO IN LEGNO**

BOTTOM WOODEN SHELF FINISHES

laccature/laquerings (art. CAPIDL)

- |                                     |                                    |
|-------------------------------------|------------------------------------|
| <input type="radio"/> TL - Talco    | <input type="radio"/> AV - Avena   |
| <input type="radio"/> PM - Pomice   | <input type="radio"/> CM - Cemento |
| <input type="radio"/> BR - Brina    | <input type="radio"/> BA - Basalto |
| <input type="radio"/> AN - Arenaria | <input type="radio"/> MU - Muschio |

essenze legno/wood essences (art. CAPIDE)

- |   |  |
|---|--|
| <input type="radio"/> RG - Rovere Grigio    | <input type="radio"/> RO - Rovere Nero |
| <input type="radio"/> RS - Rovere Sbiancato | <input type="radio"/> EU - Eucalipto   |
| <input type="radio"/> RN - Rovere Naturale  |  |

art. **CAPIDM**

**FINITURE PIANO IN MARMO**

MARBLE BOTTOM SHELF FINISHES

- |   |
|---|
| <input type="radio"/> MB - Bianco Carrara Gioia |
| <input type="radio"/> MN - Nero Marquina        |
| <input type="radio"/> AZ - Azul Noche           |

art. **CASTD**

**FINITURE STRUTTURA**

FRAMEWORK FINISHES

verniciature\_coatings

- |  |
|--|
| <input type="radio"/> NM - Nero Matt         |
| <input type="radio"/> BZ - Bronzo Spazzolato |
| <input type="radio"/> CM - Cemento           |

Le Acque di Cielo

- |                                      |
|--------------------------------------|
| <input type="radio"/> OL - Oltremare |
| <input type="radio"/> SM - Smeraldo  |
| <input type="radio"/> AL - Alga      |
| <input type="radio"/> CO - Corallo   |
| <input type="radio"/> NI - Ninfea    |
| <input type="radio"/> AM - Anemone   |

**N.B. Il lavabo è monoforo predisposto 5 fori, su richiesta può essere prodotto senza foro**

*N.B. The washbasin has 1 hole prepared 5 holes ; may be made without holes upon request*

**DATA**  
DATE

**FIRMA DEL CLIENTE**  
SIGNATURE

ATTENZIONE:  
La rappresentazione delle finiture è puramente indicativa. Verificare le finiture con le relative cartelle.

Ogni oggetto possiede la peculiarità di essere elaborato secondo principi puramente tradizionali, in modo da garantirne l'assoluta originalità ed unicità. Le eventuali piccole variazioni di colore, tono o venature fra gli articoli sono da considerarsi pregi e non difetti, in quanto garanzia della fattura manuale del prodotto, che fa di ogni oggetto Cielo un pezzo unico ed esclusivo, lontano dall'omologazione industriale. In fase d'ordine si intendono, pertanto, accettate tali tolleranze che non possono dare adito a contestazioni di alcun genere.

Verificare sempre le disponibilità e i tempi di consegna con il commerciale.

ATTENTION:  
The representation of the finishes is merely indicative. Please choose the finishes using the folders.

Every item possesses that particular feature of being processed according to purely traditional principles that guarantee its absolute originality and uniqueness. The small variations in colour, hues or streaks on the items are to be considered as qualities and not defects, since they warranty the handcrafted processing which makes each Cielo item a unique and exclusive piece that cannot be compared to industrial standardization. When making the order, the client implicitly accepts those various features that may give rise to claims of any sort.

Always check the availability and delivery time with the commercial department.



# Catino Rettangolare



modelli disponibili / available models

## I CATINI collection

### Catino Rettangolare

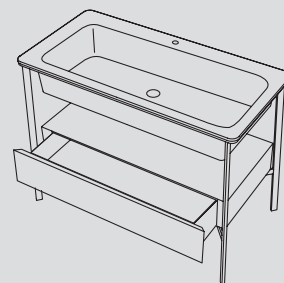

Catino Rettangolare con cassetto  
/ with drawer

110 x 58,5 x 83 h

finiture / finishes

#### LAVABO IN CERAMICA / CERAMIC WASHBASIN

##### Le Terre di Cielo



##### Le Acque di Cielo

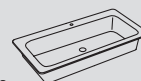

CALAR

#### STRUTTURA IN ACCIAIO / STEEL FRAMEWORK

##### verniciature / coatings

##### Le Acque di Cielo



CASTD

#### CASSETTO IN LEGNO / WOODEN DRAWER

##### Le Terre di Cielo laccature / lacquers



##### essenze / wooden finishes

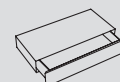
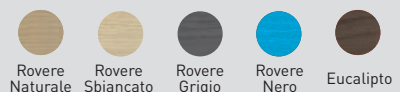

CACDL  
CACDE

note tecniche lavabo / washbasin technical notes

○ ○ ○ ○ ○  
1 foro predisposto 5 fori  
with 1 holes prepared 5 holes

●  
senza foro su richiesta  
no tap hole on request

☒  
senza troppopieno  
without overflow

ⓘ  
composizione obbligatoria:  
lavabo + struttura + cassetto  
mandatory combination:  
washbasin + framework + drawer



# Modulo Ordine Catino Rettangolare con Cassetto

## Catino Rettangolare Order Form

# cielo

CLIENTE/client:  ORD. REF.:

QUANTITA'/quantity:  EMAIL:

INDICARE CON UN SEGNO LE FINITURE SCELTE PER I DIVERSI COMPONENTI

INDICATE WITH A TICK, THE CHOSEN FINISHES FOR ALL THE COMPONENTS

art. **CASTD**

### FINITURE STRUTTURA

FRAMEWORK FINISHES

verniciature\_coatings

- NM - Nero Matt**
- BZ - Bronzo Spazzolato**
- CM - Cemento**

Le Acque di Cielo

- OL - Oltremare**
- SM - Smeraldo**
- AL - Alga**
- CO - Corallo**
- NI - Ninfea**
- AM - Anemone**

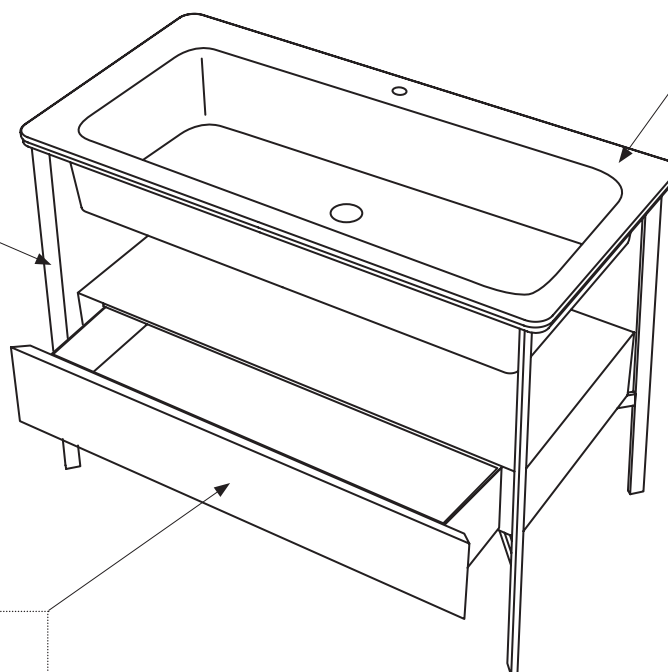

art. **CALAR \ CALARSF**

### FINITURE LAVABO

WASHBASIN SHELF FINISHES

- Bianco/white - glossy**

Le Terre di Cielo

- |   |  |
|---|--|
| <input type="radio"/> <b>TL - Talco</b>   | <input type="radio"/> <b>AN - Arenaria</b> |
| <input type="radio"/> <b>PM - Pomice</b>  | <input type="radio"/> <b>AV - Avena</b>    |
| <input type="radio"/> <b>BR - Brina</b>   | <input type="radio"/> <b>LN - Lino</b>     |
| <input type="radio"/> <b>BA - Basalto</b> | <input type="radio"/> <b>AG - Agave</b>    |
| <input type="radio"/> <b>LV - Lavagna</b> | <input type="radio"/> <b>MU - Muschio</b>  |
| <input type="radio"/> <b>CM - Cemento</b> | <input type="radio"/> <b>PL - Polvere</b>  |
| <input type="radio"/> <b>FN - Fango</b>   | <input type="radio"/> <b>CP - Cipria</b>   |
| <input type="radio"/> <b>CA - Cacao</b>   | <input type="radio"/> <b>CN - Canapa</b>   |

Le Acque di Cielo

- |   |   |
|---|---|
| <input type="radio"/> <b>OL - Oltremare</b> | <input type="radio"/> <b>CO - Corallo</b> |
| <input type="radio"/> <b>SM - Smeraldo</b>  | <input type="radio"/> <b>NI - Ninfea</b>  |
| <input type="radio"/> <b>AL - Alga</b>      | <input type="radio"/> <b>AM - Anemone</b> |

art. **CACDL / art. CACDE**

### FINITURE CASSETTO IN LEGNO

BOTTOM WOODEN DRAWER FINISHES

laccature/laquerings (art. CACDL)

- |  |   |
|--|---|
| <input type="radio"/> <b>TL - Talco</b>    | <input type="radio"/> <b>AV - Avena</b>   |
| <input type="radio"/> <b>PM - Pomice</b>   | <input type="radio"/> <b>CM - Cemento</b> |
| <input type="radio"/> <b>BR - Brina</b>    | <input type="radio"/> <b>BA - Basalto</b> |
| <input type="radio"/> <b>AN - Arenaria</b> | <input type="radio"/> <b>MU - Muschio</b> |

essenze legno/wood essences (art. CACDE)

- |  |   |
|--|---|
| <input type="radio"/> <b>RG - Rovere Grigio</b>    | <input type="radio"/> <b>RO - Rovere Nero</b> |
| <input type="radio"/> <b>RS - Rovere Sbiancato</b> | <input type="radio"/> <b>EU - Eucalipto</b>   |
| <input type="radio"/> <b>RN - Rovere Naturale</b>  |   |

**N.B. Il lavabo è monoforo predisposto 5 fori, su richiesta può essere prodotto senza foro**

*N.B. The washbasin has 1 hole prepared 5 holes ; may be made without holes upon request*

**DATA**

DATE

**FIRMA DEL CLIENTE**

SIGNATURE

ATTENZIONE:

La rappresentazione delle finiture è puramente indicativa. Verificare le finiture con le relative cartelle.

Ogni oggetto possiede la peculiarità di essere elaborato secondo principi puramente tradizionali, in modo da garantirne l'assoluta originalità ed unicità. Le eventuali piccole variazioni di colore, tono o venature fra gli articoli sono da considerarsi pregi e non difetti, in quanto garanzia della fattura manuale del prodotto, che fa di ogni oggetto Cielo un pezzo unico ed esclusivo, lontano dall'omologazione industriale. In fase d'ordine si intendono, pertanto, accettate tali tolleranze che non possono dare adito a contestazioni di alcun genere.

Verificare sempre le disponibilità e i tempi di consegna con il commerciale.

ATTENTION:

The representation of the finishes is merely indicative. Please choose the finishes using the folders.









Every item possesses that particular feature of being processed according to purely traditional principles that guarantee its absolute originality and uniqueness. The small variations in colour, hues or streaks on the items are to be considered as qualities and not defects, since they warranty the handcrafted processing which makes each Cielo item a unique and exclusive piece that cannot be compared to industrial standardization. When making the order, the client implicitly accepts those various features that may give rise to claims of any sort.

Always check the availability and delivery time with the commercial department.



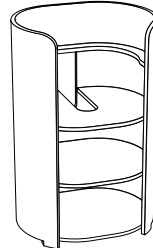



	<b>Size (cm)</b> Medidas Dimensions Maße Размеры	<b>Product code</b> Artículo Article Artikel Артикул	<b>Net weight (Kg)</b> Peso neto Poids net Reingewicht вес нетто	<b>Finishes</b> Acabados Finitions Farbe Отделки	<b>Euro</b> Евро	<b>Pz.</b> шт. pallet Italia	<b>Pz.</b> шт. pallet Cont.
 <p><b>Tiberio oval 56 on top bowl with one hole</b>                      Lavabo Tiberio oval 56 con 1 agujero / Lavabo Tiberio ovale 56 tour monotrou / Aufsatzbecken Oval Catino 56 / Раковина овальный Tiberio 56 одно отверстие под смеситель</p>	56 x 48 x h18	CALA056F(X)*  CALA056SF(X)* no tap hole sin agujero sans orifice ohne Loch без отверстия	12,00	<ul style="list-style-type: none"> <li> <b>Gloss White</b></li> <li> <b>Le Terre di Cielo</b></li> <li> <b>Le Acque di Cielo</b></li> </ul>	705,00  919,00  919,00		
 <p><b>Lacquered cabinet</b>                      Mueble lacado \ Meuble laqué \ Möbel lackiert \ Тумба крашеная</p> <hr/> <p><b>Cabinet in wooden finish</b>                      Mueble en madera \ Meuble bois \ Möbel aus Holz \ Тумба в деревянной отделке</p>	56 x 46 x h 84	CAMTL(X)*  CAMTE(X)*	22,00  22,00	<ul style="list-style-type: none"> <li> <b>Le Terre di Cielo*</b></li> <li> <b>Le Acque di Cielo</b></li> </ul> <hr/> <ul style="list-style-type: none"> <li> <b>Essenze Rovere *</b></li> </ul>	2193,00 2872,00  2465,00		

**mandatory: washbasin + cabinet**  
 obligatoire: lavabo + meuble  
 obligatoria: lavabo + meuble  
 obligatorische: Waschbecken + Möbel  
 обязательное: раковина + тумба









**Technical symbols legend**  
 Símbolos técnicos clave | Légende symboles techniques | Technische Zeichenerklärung | Перечень технических символов

-  **installation on the cabinet**  
 instalación en el mueble / installation sur le meuble / Montage am Schrank / установка умывальника на тумбу
-  **with 1 hole prepared 3 holes**  
 con 1 agujero predispuesto para 3 / avec 1 trou prédisposition à 3 trous / mit 1-Loch auf 3-Loch durchschlagbar / два отверстия с возможностью выполнения шесть отверстий
-  **no tap hole**  
 sin agujero / sans orifice / ohne Loch / без отверстия под смеситель
-  **without overflow**  
 sin rebosadero / sans trop-plein / ohne Überlauf / без слива-перелива
-  **all sides are enamelled**  
 con todos los lados esmaltados / avec tous les côtés émaillés / alle Seiten glasiert / все стороны покрыты эмалью

• **Essenze Rovere available for cabinet** / *Essenze Rovere disponibles para mueble | Essenze Rovere disponibles pour le meuble | Für Möbel erhältliche Essenze Rovere | крашеная отделка Essenze Rovere доступна для ящика и столешницы*

-  **RO - Rovere Nero**
-  **RG - Rovere Grigio**
-  **RN - Rovere Naturale**
-  **RS - Rovere Sbiancato**

























\* **Terre di Cielo laquering available for cabinet** / *lacados Terre di Cielo disponibles para mueble | laquages Terre di Cielo disponibles pour le meuble | Für Möbel erhältliche Lackierungen Terre di Cielo | крашеная отделка Terre di Cielo доступна для ящика и столешницы*

-  **TL - Talco**
-  **PM - Pomice**
-  **BR - Brina**
-  **AN - Arenaria**
-  **AV - Avena**
-  **CM - Cemento**
-  **BA - Basalto**
-  **MU - Muschio**

# I Catini - Tiberio

drains and siphons / desagües y sifones / les drains et les siphons / Ablaufgarnituren und Siphons / Донные клапаны и сифоны

# cielo















	<b>Product code</b> Artículo Article Artikel Артикул	<b>Net weight</b> (Kg) Peso neto Poids net Reingewicht вес нетто	<b>Finishes</b> Acabados Finitions Farbe Отделка	<b>Euro</b> Евро
 <p><b>Universal click/clack drain in CHROME with ceramic lid</b> Válvula universal click/clack Cromado con tapa en cerámica Bonde universelle clic/clac Chromé avec clapet en céramique Universal-Ablaufgarnitur Click-Clack Chrom mit Keramikstopfen Универсальный донный клапан click/clack хром с керамической крышкой</p>	PIL01(X)*	0,40	 <b>Gloss White</b>  <b>Le Terre di Cielo</b>  <b>Le Acque di Cielo</b>	<b>95,00</b> <b>139,00</b> <b>139,00</b>
 <p><b>Universal click/clack drain in BLACK MATT finish with ceramic lid</b> Válvula universal click/clack Negro Matt con tapa en cerámica Bonde universelle clic/clac Noir Mat avec clapet en céramique / Universal-Ablaufgarnitur Click-Clack Matt Schwarz mit Keramikstopfen / Универсальный донный клапан click/clack черный матовый с керамической крышкой</p>	PIL01NM(X)*	0,40	 <b>Gloss White</b>  <b>Le Terre di Cielo</b>  <b>Le Acque di Cielo</b>	<b>120,00</b> <b>169,00</b> <b>169,00</b>
 <p><b>Universal click/clack drain in CEMENTO finish with ceramic lid</b> Válvula universal click/clack Cemento con tapa en cerámica Bonde universelle clic/clac Cemento avec clapet en céramique Universal-Ablaufgarnitur Click-Clack Cement mit Keramikstopfen Универсальный донный Cemento click/clack с керамической крышкой</p>	PIL01CM(X)*	0,40	 <b>Gloss White</b>  <b>Le Terre di Cielo</b>  <b>Le Acque di Cielo</b>	<b>120,00</b> <b>169,00</b> <b>169,00</b>
 <p><b>Universal click/clack drain in BRONZE with ceramic lid</b> Válvula universal click/clack Bronce con tapa en cerámica Bonde universelle clic/clac Bronze avec clapet en céramique Universal-Ablaufgarnitur Click-Clack Bronze mit Keramikstopfen Универсальный донный клапан click/clack бронза с керамической крышкой</p>	PIL01BR(X)*	0,40	 <b>Gloss White</b>  <b>Le Terre di Cielo</b>  <b>Le Acque di Cielo</b>	<b>135,00</b> <b>182,00</b> <b>182,00</b>
 <p><b>CHROMED siphon</b> Sifone Cromado \ Siphon Chromé \ Siphon Verchromt \ сифон Chrome</p>	SISP	0,93	 <b>Chrome</b>	<b>133,00</b>
 <p><b>MATT BLACK siphon</b> Sifone Negro Mate \ Siphon Noir Mat \ Siphon Schwarz Matt \ Сифон Черный матовый</p>	SIFN	0,93	 <b>Matt Black</b>	<b>194,00</b>
 <p><b>CEMENTO siphon</b> Sifone Cemento \ Siphon Cemento \ Siphon Cemento \ сифон Cemento</p>	SIFCM	0,93	 <b>Cemento</b>	<b>194,00</b>
 <p><b>BRONZE siphon</b> Sifone Bronce \ Siphon Bronze \ Siphon Bronze \ бронза сифон</p>	SIFBR	0,93	 <b>Bronze</b>	<b>220,00</b>

Le Terre di Cielo	 TL - Talco	 PM - Pomice	 BR - Brina	 BA - Basalto	 LV - Lavagna	 CM - Cemento	 FN - Fango	 CA - Cacao
	 AN - Arenaria	 AV - Avena	 LN - Lino	 AG - Agave	 MU - Muschio	 PL - Polvere	 CP - Cipria	 CN - Canapa
Le Acque di Cielo	 OL - Oltremare	 SM - Smeraldo	 AL - Alga	 CO - Corallo	 NI - Ninfea	 AM - Anemone		

# I Catini

washbasins / lavabi / Aufsatzbecken / Раковина

























# cielo

	Size (cm) Medidas Dimensions Maße Размеры	Product code Artículo Article Artikel Артикул	Net weight (Kg) Peso neto Poids net Reingewicht вес нетто	Finishes Acabados Finitions Farbe Отделки	Euro Евро	Pz. шт. pallet Italia	Pz. шт. pallet Cont.
  <p><b>Round on top bowl Catino ø45</b> Cubela de apoyo Catino ronda ø45 Vasque à poser Catino tour ø45 Aufsatzbecken Runde Catino ø45 Раковина круглый Catino ø45</p>	ø45 x h16	CALAT45(X)*	9,00	<ul style="list-style-type: none"> <li> <b>Gloss White</b></li> <li> <b>Le Terre di Cielo</b></li> <li> <b>Le Acque di Cielo</b></li> </ul>	<b>643,00</b> <b>815,00</b> <b>815,00</b>	20	30
  <p><b>Oval on top bowl Catino 55</b> Cubela de apoyo Catino Oval 55 Vasque à poser Catino Oval 55 Aufsatzbecken Oval Catino 55 Раковина овальный Catino 55</p>	55 x 42 x h 16	CALA055(X)*	10,00	<ul style="list-style-type: none"> <li> <b>Gloss White</b></li> <li> <b>Le Terre di Cielo</b></li> <li> <b>Le Acque di Cielo</b></li> </ul>	<b>688,00</b> <b>896,00</b> <b>896,00</b>	14	21
  <p><b>Oval on top bowl Catino 65</b> Cubela de apoyo Catino Oval 65 Vasque à poser Catino Oval 65 Aufsatzbecken Oval Catino 65 Раковина овальный Catino 65</p>	65 x 44 x h 16	CALA065(X)*	13,00	<ul style="list-style-type: none"> <li> <b>Gloss White</b></li> <li> <b>Le Terre di Cielo</b></li> <li> <b>Le Acque di Cielo</b></li> </ul>	<b>705,00</b> <b>919,00</b> <b>919,00</b>	12	21

## Technical symbols legend / Símbolos técnicos clave / Légende symboles techniques / Technische Zeichenerklärung / Перечень технических символов

 <b>all sides are enamelled</b> con todos los lados esmaltados avec tous les côtés émaillés alle Seiten glasiert все стороны покрыты эмалью	 <b>on top installation</b> Installation of apoyo installation à partir du plan Montage auf Platte установка на столешницу	 <b>without overflow</b> sin rebordillo sans trop-plein ohne Überlauf без слива-перелива	 <b>no tap holes</b> sin agujero para grifo sans orifice robinet ohne Hahnloch без отверстия под смеситель
---	---	---	---

<b>Le Terre di Cielo</b>	 TL - Talco	 PM - Pomice	 BR - Brina	 BA - Basalto	 LV - Lavagna	 CM - Cemento	 FN - Fango	 CA - Cacao
	 AN - Arenaria	 AV - Avena	 LN - Lino	 AG - Agave	 MU - Muschio	 PL - Polvere	 CP - Cipria	 CN - Canapa
<b>Le Acque di Cielo</b>	 OL - Oltremare	 SM - Smeraldo	 AL - Alga	 CO - Corallo	 NI - Ninfea	 AM - Anemone		

	<b>Product code</b> Artículo Article Artikel Артикул	<b>Net weight</b> (Kg) Peso neto Poids net Reingewicht вес нетто	<b>Finishes</b> Acabados Finitions Farbe Отделки	<b>Euro</b> Евро
 <p><b>Universal click/clack drain in CHROME with ceramic lid</b> Válvula universal click/clack Cromado con tapa en cerámica Bonde universelle clic/clac Chromé avec clapet en céramique Universal-Abflussgarnitur Click-Clack Chrom mit Keramikstopfen Универсальный донный клапан click/clack хром с керамической крышкой</p>	PIL01(X)*	0,40	 <b>Gloss White</b>	<b>95,00</b>
			 <b>Le Terre di Cielo</b>	<b>139,00</b>
			 <b>Le Acque di Cielo</b>	<b>139,00</b>
 <p><b>Universal click/clack drain in BLACK MATT finish with ceramic lid</b> Válvula universal click/clack Negro Matt con tapa en cerámica Bonde universelle clic/clac Noir Mat avec clapet en céramique Universal-Abflussgarnitur Click-Clack Matt Schwarz mit Keramikstopfen Универсальный донный клапан click/clack черный матовый с керамической крышкой</p>	PIL01NM(X)*	0,40	 <b>Gloss White</b>	<b>120,00</b>
			 <b>Le Terre di Cielo</b>	<b>169,00</b>
			 <b>Le Acque di Cielo</b>	<b>169,00</b>
 <p><b>Universal click/clack drain in CEMENTO finish with ceramic lid</b> Válvula universal click/clack Cemento con tapa en cerámica Bonde universelle clic/clac Cemento avec clapet en céramique Universal-Abflussgarnitur Click-Clack Cement mit Keramikstopfen Универсальный донный Cemento click/clack с керамической крышкой</p>	PIL01CM(X)*	0,40	 <b>Gloss White</b>	<b>120,00</b>
			 <b>Le Terre di Cielo</b>	<b>169,00</b>
			 <b>Le Acque di Cielo</b>	<b>169,00</b>
 <p><b>Universal click/clack drain in BRONZE with ceramic lid</b> Válvula universal click/clack Bronce con tapa en cerámica Bonde universelle clic/clac Bronze avec clapet en céramique Universal-Abflussgarnitur Click-Clack Bronze mit Keramikstopfen Универсальный донный клапан click/clack бронза с керамической крышкой</p>	PIL01BR(X)*	0,40	 <b>Gloss White</b>	<b>135,00</b>
			 <b>Le Terre di Cielo</b>	<b>182,00</b>
			 <b>Le Acque di Cielo</b>	<b>182,00</b>
 <p><b>CHROMED siphon</b> Sifone Cromado \ Siphon Chromé \ Siphon Verchromt \ сифон Chrome</p>	SISP	0,93	 <b>Chrome</b>	<b>133,00</b>
 <p><b>MATT BLACK siphon</b> Sifone Negro Mate \ Siphon Noir Mat \ Siphon Schwarz Matt \ Сифон Черный матовый</p>	SIFN	0,93	 <b>Matt Black</b>	<b>194,00</b>
 <p><b>CEMENTO siphon</b> Sifone Cemento \ Siphon Cemento \ Siphon Cemento \ сифон Cemento</p>	SIFCM	0,93	 <b>Cemento</b>	<b>194,00</b>
 <p><b>BRONZE siphon</b> Sifone Bronce \ Siphon Bronze \ Siphon Bronze \ бронза сифон</p>	SIFBR	0,93	 <b>Bronze</b>	<b>220,00</b>



## CIELO RIMLESS 2.0.1®



### Wall-hung wc with fixing kit (4,5 LT) - rimless 2.0.1

Inodoro suspendido completo con fijaciones (4,5 LT) - sin brida - rimless 2.0.1 \ Cuvette suspendue avec fixations (4,5 LT) - sans bride - rimless 2.0.1 \ Wand-WC mit Befestigungskit (4,5 lt.) - ohne Spülrand - rimless 2.0.1 Подвесной унитаз в комплекте с крепежами (4,5 литр) - без ободка - rimless 2.0.1

Size (cm) Medidas Dimensions Maße Размеры	Product code Artículo Article Artikel Артикул	Net weight (Kg) Peso neto Poids net Reingewicht вес нетто	Finishes Acabados Finitions Farbe Отделки	Euro Евро	Pz. шт. pallet Italia	Pz. шт. pallet Cont.
56 x 38 x h 27	CAVSK(X)*	21,00	<input type="radio"/> Gloss White <input type="radio"/> *X = TL - Talco <input type="radio"/> Le Terre di Cielo * <input type="radio"/> Le Acque di Cielo	550,00 781,00 885,00 885,00	18	18
<b>QUICK RELEASE HINGES</b>	CPVCAT	2,00	<input type="radio"/> Gloss White	115,00		
<b>QUICK RELEASE HINGES</b>	CPVCATF(X)*	2,00	<input type="radio"/> Gloss White <input type="radio"/> *X = TL - Talco <input type="radio"/> Le Terre di Cielo # <input type="radio"/> Le Acque di Cielo	175,00 331,00 345,00 345,00		
<b>Impact and acoustic protection panel</b> / Protección antigolpes y acústica / Protection acoustique et anti-choc / Stoss- und Schalldämmung / Противоударная и акустическая защита	PAA	0,16		17,00		
<b>Couple of fixing brackets for wall-hung wc/bidet</b> / Pareja de estribo para Inodoro/Bidet suspendido / Étriers de fixation pour Wc/Bidet suspendus / 1 Paar Halterungen für wandhängendes Wc/Bidet / Монтажная рама для подвесного унитаза/ биде	508	2,00		39,00		

### Technical symbols legend

Simbolos técnicos clave | Légende symboles techniques | Technische Zeichenerklärung | Перечень технических символов













**Acque di Cielo available for wc-bidet** / Acque di Cielo disponibles para wc-bidet / Acque di Cielo disponibles pour cuvette-bidet / Für das WC/Bidet erhältliche Ausführungen Acque di Cielo / Отделка Acque di Cielo доступны для унитаза и биде



**# Terre di Cielo finishes available for wc-bidet** / Acabados Terre di Cielo disponibles para wc-bidet / Finitions Terre di Cielo disponibles pour cuvette-bidet / Für das WC/Bidet erhältliche Ausführungen Terre di Cielo / Отделка Terre di Cielo доступны для унитаза и биде



 		<b>Size (cm)</b> Medidas Dimensions Maße Размеры	<b>Product code</b> Artículo Article Artikel Артикул	<b>Net weight(Kg)</b> Peso neto Poids net Reingewicht вес нетто	<b>Finishes</b> Acabados Finitions Farbe Отделки	<b>Euro</b> Евро	<b>Pz.</b> шт. pallet Italia	<b>Pz.</b> шт. pallet Cont.
<b>Wall-hung one hole bidet with fixing kit</b> Bidé suspendido monoagujero completo con fijaciones / Bidet suspendu monotrou avec fixation / Wand-Bidet einloch mit Befestigungskit / Биде подвесное с одним отверстием под смеситель, в комплекте с крепежами		56 x 38 x h27	CABS(X)*	18,00	● Gloss White ● *X = TL - Talco ● Le Terre di Cielo * ● Le Acque di Cielo	550,00 781,00 885,00 885,00	18	18
 <b>Lowered siphon (recommended)</b> Sifon para lavabo Le Giare (aconsejado) / Siphon pour lavabo Le Giare (informé) / Siphon für Waschtisch Le Giare (empfohlen) / Сифон для раковины Le Giare(рекомендуется)			SIFR	0,51		76,00		
 <b>Impact and acoustic protection panel /</b> Protección antigolpes y acústica / Protection acoustique et anti-choc / Stoss- und Schalldämmung / Противударная и акустическая защита			PAA	0,16		17,00		
 <b>Couple of fixing brackets for wall-hung wc/bidet</b> Pareja de estribo para Inodoro/ Bidet suspendido / Étriers de fixation pour Wc/Bidet suspendus / 1 Paar Halterungen für wandhängendes Wc/Bidet / Монтажная рама для подвесного унитаза/биде		3,3 x 18,5 x 55 h	508	2,00		39,00		
 <b>Universal click/clack drain in CHROME with ceramic lid</b> Válvula universal click/clack Cromado con tapa en cerámica / Bonde universelle clic/clac Chromé avec clapet en céramique / Universal-Abflussgarnitur Click-Clack Chrom mit Keramikstopfen / Универсальный донный клапан click/clack хром с керамической крышкой			PIL01(X)*	0,40	● Gloss White ● Le Terre di Cielo ● Le Acque di Cielo	95,00 139,00 139,00		
 <b>Universal click/clack drain in BLACK MATT finish with ceramic lid</b> / Válvula universal click/clack Negro Matt con tapa en cerámica / Bonde universelle clic/clac Noir Mat avec clapet en céramique / Universal-Abflussgarnitur Click-Clack Matt Schwarz mit Keramikstopfen / Универсальный донный клапан click/clack черный матовый с керамической крышкой			PIL01NM(X)*	0,40	● Gloss White ● Le Terre di Cielo ● Le Acque di Cielo	120,00 169,00 169,00		
 <b>Universal click/clack drain in CEMENTO finish with ceramic lid</b> / Válvula universal click/clack Cemento con tapa en cerámica / Bonde universelle clic/clac Cemento avec clapet en céramique / Universal-Abflussgarnitur Click-Clack Cement mit Keramikstopfen / Универсальный донный Cemento click/clack с керамической крышкой			PIL01CM(X)*	0,40	● Gloss White ● Le Terre di Cielo ● Le Acque di Cielo	120,00 169,00 169,00		
 <b>Universal click/clack drain in BRONZE with ceramic lid</b> Válvula universal click/clack Bronce con tapa en cerámica / Bonde universelle clic/clac Bronze avec clapet en céramique / Universal-Abflussgarnitur Click-Clack Bronze mit Keramikstopfen / Универсальный донный клапан click/clack бронза с керамической крышкой			PIL01BR(X)*	0,40	● Gloss White ● Le Terre di Cielo ● Le Acque di Cielo	135,00 182,00 182,00		

## Installation only with lowered siphon

 Instalación prevista sólo con sifón rebajado  
 Installation prévue uniquement avec siphon abaissé  
 Einbau nur mit abgeseenktem Siphon  
 Предусмотрена установка только с заниженным сифоном

## Technical symbols legend

Simbolos técnicos clave | Légende symboles techniques | Technische Zeichenerklärung | Перечень технических символов

 <b>with overflow</b> con rebosadero avec trop-plein mit Überlauf с переливом	 <b>one tap hole</b> con 1 agujero monotrou 1-Loch одно отверстие под смеситель	 <b>wall-hung installation</b> instalación suspendida installation suspendue wandhängende Montage подвесная установка	 <b>with fixing parts</b> fijaciones incluidas fixations incluses inklusive Befestigungen в комплекте с крепежами
---	--	--	--

**Acque di Cielo available for wc-bidet** / Acque di Cielo disponibles para wc-bidet / Acque di Cielo disponibles pour cuvette-bidet / Für das WC/Bidet erhältliche Ausführungen Acque di Cielo / Отделки Acque di Cielo доступны для унитаза и биде

● OL - Oltremare ● SM - Smeraldo ● AL - Alga ● CO - Corallo ● NI - Ninfea ● AM - Anemone

**# Terre di Cielo finishes available for wc-bidet** / Acabados Terre di Cielo disponibles para wc-bidet / Finitions Terre di Cielo disponibles pour cuvette-bidet / Für das WC/Bidet erhältliche Ausführungen Terre di Cielo / Отделки Terre di Cielo доступны для унитаза и биде

● TL - Talco ● PM - Pomice ● BR - Brina ● AN - Arenaria ● AV - Avena ● CM - Cemento  
 ● BA - Basalto ● LV - Lavagna





# I Catini - Ottavia

bath tubs / bañeras / baignoires / Badewannen / ванны

# cielo



## Ottavia LivingTec bathtub with framework in Matt Black finish

Bañera de LivingTec Ottavia con estructura en Nero Matt / Baignoire in LivingTec Ottavia meuble console en acier émaillé Noir Mat / Badewanne aus livingtec Ottavia mit Gestell aus Stahl matt Schwarz lackiert / ванна LivingTec Ottavia со структурой в отделке Nero Matt

## Ottavia LivingTec bathtub with framework in Cemento finish

Bañera de LivingTec Ottavia con estructura en Cemento / Baignoire in LivingTec Ottavia meuble console en acier émaillé Cemento / Badewanne aus livingtec Ottavia mit Gestell aus Stahl Cemento lackiert / ванна LivingTec Ottavia со структурой в отделке Cemento

## Ottavia LivingTec bathtub with framework in Brushed Bronze finish

Bañera de LivingTec Ottavia con estructura en bronce cepillado / Baignoire in LivingTec Ottavia meuble console en acier émaillé bronze brossé / Badewanne aus livingtec Ottavia mit Gestell aus Stahl Bronze Gebürstet lackiert / ванна LivingTec Ottavia со структурой в отделке Bronzo Spazzolato



## Bathtub waste (mandatory)

Sistema de descarga para bañera (obligatorio)  
Système de chasse pour baignoire (nécessaire)  
Ablaufgarnitur für Badewanne (geböten)  
Выхлопная система для ванна (обязательный)

Size (cm) Medidas Dimensions Maße Размеры	Product code Artículo Article Artikel Артикул	Net weight (Kg) Peso neto Poids net Reingewicht вес нетто	Finishes Acabados Finitions Farbe Отделки	Euro Евро	Pz. шт. pallet Italia	Pz. шт. pallet Cont.
170 x 80 x h 56	CABATNM(X)*	139,00	<ul style="list-style-type: none"> <li><input type="radio"/> Matt White</li> <li><input type="radio"/> Brina</li> <li><input type="radio"/> Arenaria</li> </ul>	<p>7388,00</p> <p>9983,00</p> <p>9983,00</p>		
170 x 80 x h 56	CABATCM(X)*	139,00	<ul style="list-style-type: none"> <li><input type="radio"/> Matt White</li> <li><input type="radio"/> Brina</li> <li><input type="radio"/> Arenaria</li> </ul>	<p>7436,00</p> <p>10.030,00</p> <p>10.030,00</p>		
170 x 80 x h 56	CABATBZ(X)*	139,00	<ul style="list-style-type: none"> <li><input type="radio"/> Matt White</li> <li><input type="radio"/> Brina</li> <li><input type="radio"/> Arenaria</li> </ul>	<p>7696,00</p> <p>10.290,00</p> <p>10.290,00</p>		
	SHCOMEC	0,40		131,00		

# I Catini - Ofelia

bath tubs / bañeras / baignoires / Badewannen / ванны

# cielo



## Ofelia LivingTec bathtub with framework in Matt Black finish

Bañera de LivingTec Ofelia con estructura en Nero Matt / Baignoire in LivingTec Ofelia meuble console en acier émaillé Noir Mat / Badewanne aus livingtec Ofelia mit Gestell aus Stahl matt Schwarz lackiert / ванна LivingTec Ofelia со структурой в отделке Nero Matt

## Ofelia LivingTec bathtub with framework in Cemento finish

Bañera de LivingTec Ofelia con estructura en Cemento / Baignoire in LivingTec Ofelia meuble console en acier émaillé Cemento / Badewanne aus livingtec Ofelia mit Gestell aus Stahl Cemento lackiert / ванна LivingTec Ofelia со структурой в отделке Cemento

## Ofelia LivingTec bathtub with framework in Brushed Bronze finish

Bañera de LivingTec Ofelia con estructura en bronce cepillado / Baignoire in LivingTec Ofelia meuble console en acier émaillé bronze brossé / Badewanne aus livingtec Ofelia mit Gestell aus Stahl Bronze Gebürstet lackiert / ванна LivingTec Ofelia со структурой в отделке Bronzo Spazzolato



## Bathtub waste (mandatory)















Sistema de descarga para bañera (obligatorio)  
Système de chasse pour baignoire (nécessaire)  
Ablaufgarnitur für Badewanne (geböten)  
Выхлопная система для ванна (обязательный)

Size (cm)	Product code	Net weight (kg)	Finishes	Euro	Pz.	Pz.
Medidas Dimensions Maße Размеры	Artículo Article Artikel Артикул	Peso neto Poids net Reingewicht вес нетто	Acabados Finitions Farbe Отделки	Евро	шт. pallet Italia	шт. pallet Cont.
157 x 93 x h 69	CASBATNM(X)*	126,00	<ul style="list-style-type: none"> <li><input type="radio"/> Matt White</li> <li><input type="radio"/> Brina</li> <li><input type="radio"/> Arenaria</li> </ul>	7388,00 9983,00 9983,00		
157 x 93 x h 69	CASBATCM(X)*	126,00	<ul style="list-style-type: none"> <li><input type="radio"/> Matt White</li> <li><input type="radio"/> Brina</li> <li><input type="radio"/> Arenaria</li> </ul>	7436,00 10.030,00 10.030,00		
157 x 93 x h 69	CASBATBZ(X)*	126,00	<ul style="list-style-type: none"> <li><input type="radio"/> Matt White</li> <li><input type="radio"/> Brina</li> <li><input type="radio"/> Arenaria</li> </ul>	7696,00 10.290,00 10.290,00		
	SHCOMECC	0,40		131,00		

# I Catini - Augusto

shower tray / plato de ducha / Receveur de douche / Duschwanne / Душевой поддон

# cielo

	Size (cm) Medidas Dimensions Maße Размеры	Product code Artículo Article Artikel Артикул	Net weight (Kg) Peso neto Poids net Reingewicht вес нетто	Finishes Acabados Finitions Farbe Отделки	Euro	Pz. шт. pallet Italia	Pz. шт. pallet Cont.
 <p><b>Augusto Shower tray</b> Plato de ducha Augusto Receveur de douche Augusto Duschwanne Augusto Душевой поддон Augusto</p>	106 x 106 x h 20	PDCA106(X)*	76,50	<ul style="list-style-type: none"> <li> <b>Gloss White</b></li> <li> <b>Le Terre di Cielo</b></li> <li> <b>Le Acque di Cielo</b></li> </ul>	<p>1329,00</p> <p>1733,00</p> <p>1733,00</p>		
 <p><b>Shower tray siphon with chrome cover</b> Valvula cromada para plato e ducha Bonde de douche chromée pour la gamme Duschwannen Ablauf verchromt Донный клапан для душевого поддона, хром</p>		SIF90	0,25	<ul style="list-style-type: none"> <li> <b>Chrome</b></li> </ul>	48,00		
 <p><b>Adaptable shower tray waste with ceramic cover</b> valvula desagüe con tapa de cerámica adaptable Bonde adaptable avec cache-écoulement en céramique Auslauf anpassungsfähig mit Deckel aus Keramik Донный клапан в комплекте с накладкой из керамики</p>		SIF90CE(X)*	0,50	<ul style="list-style-type: none"> <li> <b>Glossy White</b></li> <li> <b>Le Terre di Cielo</b></li> <li> <b>Le Acque di Cielo</b></li> </ul>	<p>99,00</p> <p>198,00</p> <p>198,00</p>		
 <p><b>Ceramic cover</b> Sólo tapa de cerámica para valvula Cache-écoulement en céramique Deckel aus Keramik Керамическая накладка для донного клапана</p>		COPCE(X)*	0,30	<ul style="list-style-type: none"> <li> <b>Glossy White</b></li> <li> <b>Le Terre di Cielo</b></li> <li> <b>Le Acque di Cielo</b></li> </ul>	<p>63,00</p> <p>132,00</p> <p>132,00</p>		











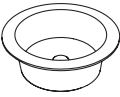





## Technical symbols legend

Simbolos técnicos clave | Légende symboles techniques | Technische Zeichenerklärung | Перечень технических символов

 **floor installation**  
Instalación de apoyo  
installation à poser  
Aufsatzmontage  
накладная установка



	Size (cm) Medidas Dimensions Maße Размеры	Product code Artículo Article Artikel Артикул	Net weight (Kg) Peso neto Poids net Reingewicht вес нетто	Finishes Acabados Finitions Farbe Отделки	Euro Евро	Pz. шт. pallet Italia	Pz. шт. pallet Cont.
 <p><b>Shower rod</b> estructura de cortina / mât pour drapeau / Vorhangstange /</p> <p><b>The shower rod is height adjustable. We recommend using 2 curtains 150 cm wide and 220 or 240 cm high. N.B. in order to avoid water leakage it is advisable to make sure that the curtain hangs inside the shower tray by at least 4 cms.</b> / La barra de la ducha es regulable en altura. Se recomienda usar 2 cortinas de ancho 150 cm y 220/240 cm de altura. P.D. Es aconsejable que la cortina entre en el plato de ducha de al menos 4 cm / La barre de douche est réglable en hauteur. Nous recommandons d'utiliser 2 rideaux de 150 cm de large et de 220/240 cm de haut. NB: Il est conseillé de veiller à ce que le rideau entre dans le receveur de douche sur au moins 4 cm pour éviter les fuites d'eau. / Die Vorhangstange ist höhenverstellbar. Wir empfehlen den Einsatz von zwei Vorhangbahnen mit Breite 150 cm und Höhe 220/240 cm. Hinweis: Der Vorhang sollte mindestens 4 cm in die Duschwanne hineinreichen, um dem Austreten von Wasser vorzubeugen. / Штанга для душа регулируется по высоте. Мы рекомендуем использовать 2 шторы шириной 150 см и высотой 220/240 см. Примечание: убедитесь, что штора минимально входит в душевой поддон 4 см, во избежание утечки воды.</p>		CAAS(x)*	2,50	<ul style="list-style-type: none"> <li>● X* = <b>NM - Matt Black</b></li> <li>● X* = <b>CM - Cemento</b></li> </ul>	551,00		561,00

	<b>Size (cm)</b> Medidas Dimensions Maße Размеры	<b>Product code</b> Artículo Article Artikel Артикул	<b>Net weight (Kg)</b> Peso neto Poids net Reingewicht вес нетто	<b>Finishes</b> Acabados Finitions Farbe Отделки	<b>Euro</b> Евро	<b>Pz.</b> шт. pallet Italia	<b>Pz.</b> шт. pallet Cont.
	Ø 50						
 <p><b>Ceramic washbasin</b>                      Lavabo de cerámica                      Lavabo en céramique                      Waschbecken aus Keramik                      Керамическая раковина</p>	Ø50 x 18h	CALAT(x)*	9,65	 <b>Gloss White</b>  <b>Le Terre di Cielo</b>  <b>Le Acque di Cielo</b>	<b>633,00</b> <b>815,00</b> <b>815,00</b>		
 <p><b>Steel framework</b>                      Estructura de acero                      Structure en acier                      Stahlgestell                      Стальной каркас</p>	Ø 50	CASTT(x)*	12,50	 <b>*X = NM Matt Black</b>  <b>*X = BZ Brushed Bronze</b>  <b>*X = CM Cemento</b>  <b>Le Acque di Cielo</b>	<b>905,00</b> <b>1219,00</b> <b>905,00</b> <b>980,00</b>		
 <p><b>Ceramic shelf</b>                      Encimera de cerámica                      Plaque en céramique                      Regal aus keramik                      Керамическая столешница</p>	Ø44 x 1,8h	CAPIT(x)*	5,25	 <b>Gloss White</b>  <b>Le Terre di Cielo</b>  <b>Le Acque di Cielo</b>	<b>213,00</b> <b>249,00</b> <b>249,00</b>		
 <p><b>Marble shelf</b>                      Encimera de mármol                      Plaque en marbre                      Marmor Regal                      Столешница из мрамора</p>	Ø44 x 1,8h	CAPITM(x)*	9,00	 <b>*X = MB Bianco Carrara</b>  <b>*X = MN Nero Marquina</b>  <b>*X = AZ Azul Noche</b>	<b>582,00</b> <b>582,00</b> <b>582,00</b>		

























**mandatory: washbasin + framework + shelf**

obligatoire: lavabo + structure + encimera  
 obligatoria: lavabo + estructura + plaque  
 obligatorische: Waschbecken + Stahlgestell + Regal  
 обязательно: раковина + Стальной каркас + столешница

**Technical symbols legend** / *Símbolos técnicos clave* / *Légende symboles techniques* / *Technische Zeichenerklärung* / *Перечень технических символов*

 **no tap holes**  
 sin agujero para grifo  
 sans orifice robinet  
 ohne Hahnloch  
 без отверстия под смеситель

 **without overflow**  
 sin rebosadero  
 sans trop-plein  
 ohne Überlauf  
 без слива-перелива

	<b>Product code</b> Artículo Article Artikel Артикул	<b>Net weight</b> (Kg) Peso neto Poids net Reingewicht вес нетто	<b>Finishes</b> Acabados Finitions Farbe Отделка	<b>Euro</b> Евро
 <p><b>Universal click/clack drain in CHROME with ceramic lid</b> Válvula universal click/clack Cromado con tapa en cerámica Bonde universelle clic/clac Chromé avec clapet en céramique Universal-Abflussgarnitur Click-Clack Chrom mit Keramikstopfen Универсальный донный клапан click/clack хром с керамической крышкой</p>	PIL01(X)*	0,40	 <b>Gloss White</b>	<b>95,00</b>
			 <b>Le Terre di Cielo</b>	<b>139,00</b>
			 <b>Le Acque di Cielo</b>	<b>139,00</b>
 <p><b>Universal click/clack drain in BLACK MATT finish with ceramic lid</b> Válvula universal click/clack Negro Matt con tapa en cerámica Bonde universelle clic/clac Noir Mat avec clapet en céramique Universal-Abflussgarnitur Click-Clack Matt Schwarz mit Keramikstopfen Универсальный донный клапан click/clack черный матовый с керамической крышкой</p>	PIL01NM(X)*	0,40	 <b>Gloss White</b>	<b>120,00</b>
			 <b>Le Terre di Cielo</b>	<b>169,00</b>
			 <b>Le Acque di Cielo</b>	<b>169,00</b>
 <p><b>Universal click/clack drain in CEMENTO finish with ceramic lid</b> Válvula universal click/clack Cemento con tapa en cerámica Bonde universelle clic/clac Cemento avec clapet en céramique Universal-Abflussgarnitur Click-Clack Cement mit Keramikstopfen Универсальный донный Cemento click/clack с керамической крышкой</p>	PIL01CM(X)*	0,40	 <b>Gloss White</b>	<b>120,00</b>
			 <b>Le Terre di Cielo</b>	<b>169,00</b>
			 <b>Le Acque di Cielo</b>	<b>169,00</b>
 <p><b>Universal click/clack drain in BRONZE with ceramic lid</b> Válvula universal click/clack Bronce con tapa en cerámica Bonde universelle clic/clac Bronze avec clapet en céramique Universal-Abflussgarnitur Click-Clack Bronze mit Keramikstopfen Универсальный донный клапан click/clack бронза с керамической крышкой</p>	PIL01BR(X)*	0,40	 <b>Gloss White</b>	<b>135,00</b>
			 <b>Le Terre di Cielo</b>	<b>182,00</b>
			 <b>Le Acque di Cielo</b>	<b>182,00</b>
 <p><b>CHROMED siphon</b> Sifone Cromado \ Siphon Chromé \ Siphon Verchromt \ сифон Chrome</p>	SISP	0,93	 <b>Chrome</b>	<b>133,00</b>
 <p><b>MATT BLACK siphon</b> Sifone Negro Mate \ Siphon Noir Mat \ Siphon Schwarz Matt \ Сифон Черный матовый</p>	SIFN	0,93	 <b>Matt Black</b>	<b>194,00</b>
 <p><b>CEMENTO siphon</b> Sifone Cemento \ Siphon Cemento \ Siphon Cemento \ сифон Cemento</p>	SIFCM	0,93	 <b>Cemento</b>	<b>194,00</b>
 <p><b>BRONZE siphon</b> Sifone Bronce \ Siphon Bronze \ Siphon Bronze \ бронза сифон</p>	SIFBR	0,93	 <b>Bronze</b>	<b>220,00</b>

Le Terre di Cielo	 TL - Talco	 PM - Pomice	 BR - Brina	 BA - Basalto	 LV - Lavagna	 CM - Cemento	 FN - Fango	 CA - Cacao
	 AN - Arenaria	 AV - Avena	 LN - Lino	 AG - Agave	 MU - Muschio	 PL - Polvere	 CP - Cipria	 CN - Canapa
Le Acque di Cielo	 OL - Oltremare	 SM - Smeraldo	 AL - Alga	 CO - Corallo	 NI - Ninfea	 AM - Anemone		



	Size (cm)	Product code	Net weight(Kg)	Finishes	Euro	Pz.	Pz.
	Medidas Dimensions Maße Размеры	Artículo Article Artikel Артикул	Peso neto Poids net Reingewicht вес нетто	Acabados Finitions Farbe Отделки	Евро	шт. pallet Italia	шт. pallet Cont.
	70 x 50						
 	<b>Ceramic washbasin</b> Lavabo de cerámica Lavabo en céramique Waschbecken aus Keramik Керамическая раковина	70 x 50 x 18h	<b>CALAO(X)*</b>	12,70	<ul style="list-style-type: none"> <li> <b>Gloss White</b> <b>758,00</b></li> <li> <b>Le Terre di Cielo</b> <b>968,00</b></li> <li> <b>Le Acque di Cielo</b> <b>968,00</b></li> </ul>		
 	<b>Ceramic washbasin with 1 hole</b> Lavabo de cerámica monoagujero Lavabo en céramique avec un trou Waschbecken aus Keramik mit 1 Hahnloch Керамическая раковина на одно отверстие	70 x 50 x 18h	<b>CALAOF(X)*</b>	13,00	<ul style="list-style-type: none"> <li> <b>Gloss White</b> <b>758,00</b></li> <li> <b>Le Terre di Cielo</b> <b>968,00</b></li> <li> <b>Le Acque di Cielo</b> <b>968,00</b></li> </ul>		
 	<b>Steel framework</b> Estructura de acero Structure en acier Stahlgestell Стальной каркас	70 x 50	<b>CASTO(X)*</b>	12,50	<ul style="list-style-type: none"> <li> <b>*X = NM - Matt Black</b> <b>1070,00</b></li> <li> <b>*X = BZ</b> <b>Brushed Bronze</b> <b>1420,00</b></li> <li> <b>*X = CM - Cemento</b> <b>1070,00</b></li> <li> <b>Le Acque di Cielo</b> <b>1146,00</b></li> </ul>		
 	<b>Lacquered drawer</b> Cajón lacado Tiroir laqué Schubfach lackiert Крашенный ящик	56 x 40 x 16,5h	<b>CACOL(X)*</b>	10,00	 <b>Le Terre di Cielo*</b> <b>1132,00</b>		
 	<b>Drawer in wooden finish</b> Cajón de madera Tiroir en bois Holzschubfach Ящик с отделкой натуральным шпоном	56 x 40 x 16,5h	<b>CACOE(X)*</b>	10,00	<b>EsSENze</b> <ul style="list-style-type: none"> <li> <b>*X = RN - Rovere Naturale</b></li> <li> <b>*X = RS - Rovere Sbiancato</b></li> <li> <b>*X = RO - Rovere Nero</b></li> <li> <b>*X = RG - Rovere Grigio</b></li> <li> <b>*X = EU - Eucalipto</b> <b>1573,00</b></li> </ul>		
 	<b>Ceramic shelf</b> Encimera de cerámica Plaque en céramique Regal aus keramik Керамическая столешница	65 x 45 x 1,8h	<b>CAPIO(X)*</b>	7,60	<ul style="list-style-type: none"> <li> <b>Gloss White</b> <b>239,00</b></li> <li> <b>Le Terre di Cielo</b> <b>308,00</b></li> <li> <b>Le Acque di Cielo</b> <b>308,00</b></li> </ul>		
 	<b>Marble shelf</b> Encimera de mármol Plaque en marbre Marmor Regal Мраморная столешница	65 x 45 x 1,8h	<b>CAPIOM(X)*</b>	15,00	<ul style="list-style-type: none"> <li> <b>*X = MB</b> <b>Bianco Carrara</b> <b>808,00</b></li> <li> <b>*X = MN</b> <b>Nero Marquina</b> <b>808,00</b></li> <li> <b>*X = AZ</b> <b>Azul Noche</b> <b>808,00</b></li> </ul>		

**mandatory: washbasin + framework + shelf or drawer**

























obligatoire: lavabo + structure + encimera o cajón  
obligatoria: lavabo + estructura + plaque ou tiroir  
obligatorische: Waschbecken + Stahlgestell + Regal oder Schubfach  
обязательное: раковина + Стальной каркас + столешница или ящик

**Technical symbols legend /**  
Simbolos técnicos clave / Légende  
symboles techniques / Technische  
Zeichenerklärung / Перечень  
технических символов

 **no tap holes**  
sin agujero para  
grifo  
sans orifice  
robinet  
ohne Hahnloch  
без отверстия  
под смеситель

 **with 1 hole prepared 3 holes**  
con 1 agujero predisposición para 3  
avec un trou prédisposition à trois trous  
mit 1-Loch auf 3-Loch durchschlagbar  
одно отверстие с возможностью  
выполнения трех отверстий

 **without overflow**  
sin rebosadero  
sans trop-plein  
ohne Überlauf  
без слива-перелива









	Product code Artículo Article Artikel Артикул	Net weight <sub>(kg)</sub> Peso neto Poids net Reingewicht вес нетто	Finishes Acabados Finitions Farbe Отделка	Euro Евро
 <p><b>Universal click/clack drain in CHROME with ceramic lid</b> Válvula universal click/clack Cromado con tapa en cerámica Bonde universelle clic/clac Chromé avec clapet en céramique Universal-Abflussgarnitur Click-Clack Chrom mit Keramikstopfen Универсальный донный клапан click/clack хром с керамической крышкой</p>	PIL01(X)*	0,40	 <b>Gloss White</b>	<b>95,00</b>
			 <b>Le Terre di Cielo</b>	<b>139,00</b>
			 <b>Le Acque di Cielo</b>	<b>139,00</b>
 <p><b>Universal click/clack drain in BLACK MATT finish with ceramic lid</b> Válvula universal click/clack Negro Matt con tapa en cerámica Bonde universelle clic/clac Noir Mat avec clapet en céramique Universal-Abflussgarnitur Click-Clack Matt Schwarz mit Keramikstopfen Универсальный донный клапан click/clack черный матовый с керамической крышкой</p>	PIL01NM(X)*	0,40	 <b>Gloss White</b>	<b>120,00</b>
			 <b>Le Terre di Cielo</b>	<b>169,00</b>
			 <b>Le Acque di Cielo</b>	<b>169,00</b>
 <p><b>Universal click/clack drain in CEMENTO finish with ceramic lid</b> Válvula universal click/clack Cemento con tapa en cerámica Bonde universelle clic/clac Cemento avec clapet en céramique Universal-Abflussgarnitur Click-Clack Cement mit Keramikstopfen Универсальный донный Cemento click/clack с керамической крышкой</p>	PIL01CM(X)*	0,40	 <b>Gloss White</b>	<b>120,00</b>
			 <b>Le Terre di Cielo</b>	<b>169,00</b>
			 <b>Le Acque di Cielo</b>	<b>169,00</b>
 <p><b>Universal click/clack drain in BRONZE with ceramic lid</b> Válvula universal click/clack Bronce con tapa en cerámica Bonde universelle clic/clac Bronze avec clapet en céramique Universal-Abflussgarnitur Click-Clack Bronze mit Keramikstopfen Универсальный донный клапан click/clack бронза с керамической крышкой</p>	PIL01BR(X)*	0,40	 <b>Gloss White</b>	<b>135,00</b>
			 <b>Le Terre di Cielo</b>	<b>182,00</b>
			 <b>Le Acque di Cielo</b>	<b>182,00</b>
 <p><b>CHROMED siphon</b> Sifone Cromado \ Siphon Chromé \ Siphon Verchromt \ сифон Chrome</p>	SISP	0,93	 <b>Chrome</b>	<b>133,00</b>
 <p><b>MATT BLACK siphon</b> Sifone Negro Mate \ Siphon Noir Mat \ Siphon Schwarz Matt \ Сифон Черный матовый</p>	SIFN	0,93	 <b>Matt Black</b>	<b>194,00</b>
 <p><b>CEMENTO siphon</b> Sifone Cemento \ Siphon Cemento \ Siphon Cemento \ сифон Cemento</p>	SIFCM	0,93	 <b>Cemento</b>	<b>194,00</b>
 <p><b>BRONZE siphon</b> Sifone Bronce \ Siphon Bronze \ Siphon Bronze \ бронза сифон</p>	SIFBR	0,93	 <b>Bronze</b>	<b>220,00</b>

With the installation of the drawer, we recommend matching it with our SISP - SIFN - SIFCM - SIFBR siphons/traps / Con la instalación del cajón aconsejamos de combinar nuestros sifones SISP - SIFN - SIFCM - SIFBR / Terre di Cielo disponibles pour les lavabos et le plan en céramique / Bei Montage der Schublade empfehlen wir unsere Siphons SISP - SIFN - SIFCM - SIFBR / При установке ящика рекомендуем сочетать наши сифоны SISP - SIFN - SIFCM - SIFBR

- Le Terre di Cielo
-  TL - Talco
  -  PM - Pomice
  -  BR - Brina
  -  BA - Basalto
  -  LV - Lavagna
  -  CM - Cemento
  -  FN - Fango
  -  CA - Cacao
  -  AN - Arenaria
  -  AV - Avena
  -  LN - Lino
  -  AG - Agave
  -  MU - Muschio
  -  PL - Polvere
  -  CP - Cipria
  -  CN - Canapa
- Le Acque di Cielo
-  OL - Oltremare
  -  SM - Smeraldo
  -  AL - Alga
  -  CO - Corallo
  -  NI - Ninfea
  -  AM - Anemone

\* Terre di Cielo laquering available for drawer /

Lacados Terre di Cielo disponibles para los cajones /  
laquages Terre di Cielo disponibles pour le tiroir /  
Für die Schublade erhältliche Lackierungen Terre di Cielo /  
крашенная отделка Terre di Cielo доступна для ящика











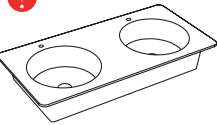







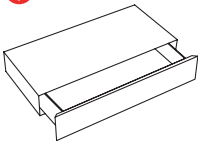

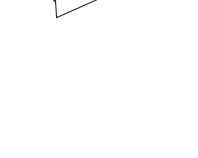







-  TL - Talco
-  PM - Pomice
-  BR - Brina
-  AN - Arenaria
-  AV - Avena
-  CM - Cemento
-  BA - Basalto
-  MU - Muschio









	Size (cm)	Product code	Net weight (Kg)	Finishes	Euro	Pz.	Pz.
	Medidas Dimensions Maße Размеры	Artículo Article Artikel Артикул	Peso neto Poids net Reingewicht вес нетто	Acabados Finitions Farbe Отделки	Евро	шт. pallet Italia	шт. pallet Cont.
	110 x 58,5						
 <b>Ceramic washbasin with 2 holes</b> Lavabo de cerámica con 2 agujero Lavabo en céramique avec 2 trou Washbecken aus Keramik mit 2-Loch Керамическая раковина на шесть отверстие	110 x 54 x 18h	CALAD(X)*  CALADSF(X)* no tap hole sin agujero - sans orificé - ohne Loch без отверстия	34,00	 <b>Gloss White</b>   <b>Le Terre di Cielo</b>   <b>Le Acque di Cielo</b>	<b>920,00</b>  <b>1338,00</b>  <b>1338,00</b>		
 <b>Steel framework</b> Estructura de acero Structure en acier Stahlgestell Стальной каркас	110 x 58,5	CASTD(X)*	23,50	 *X = <b>NM - Matt Black</b>  *X = <b>BZ Brushed Bronze</b>  *X = <b>CM Cemento</b>  <b>Le Acque di Cielo</b>	<b>1157,00</b> <b>1620,00</b> <b>1157,00</b> <b>1272,00</b>		
 <b>Lacquered drawer</b> Cajón lacado Tiroir laqué Schubfach lackiert Крашенный ящик	100 x 46 x 16,8h	CACDL(X)*	24,50	 <b>Le Terre di Cielo*</b>	<b>1132,00</b>		
 <b>Drawer in wooden finish</b> Cajón de madera Tiroir en bois Holzschubfach Ящик с отделкой натуральным шпоном	100 x 46 x 16,8h	CACDE(X)*	24,50	<b>EsSENze</b>  *X = <b>RN - Rovere Naturale</b>  *X = <b>RS - Rovere Sbiancato</b>  *X = <b>RO - Rovere Nero</b>  *X = <b>RG - Rovere Grigio</b>   *X = <b>EU - Eucalipto</b>	<b>1273,00</b>     <b>1503,00</b>		
 <b>Lacquered shelf</b> Encimera lacada Plan en bois laqué Holzregal lackiert крашенная столешница	100 x 46 x 1,8h	CAPIDL(X)*	8,00	 <b>Le Terre di Cielo*</b>	<b>368,00</b>		
 <b>Shelf in wooden finish</b> Encimera de madera Plan en bois Holzregal столешница с отделкой натуральным шпоном	100 x 46 x 1,8h	CAPIDE(X)*	8,00	<b>EsSENze</b>  *X = <b>RN - Rovere Naturale</b>  *X = <b>RS - Rovere Sbiancato</b>  *X = <b>RO - Rovere Nero</b>  *X = <b>RG - Rovere Grigio</b>   *X = <b>EU - Eucalipto</b>	<b>521,00</b>     <b>588,00</b>		
 <b>Marble shelf</b> Encimera en mármol Plan en marbre Marmor Regal Мраморная столешница	100 x 44 x 1,8h	CAPIDM(X)*	25,00	 *X = <b>MB Bianco Carrara</b>  *X = <b>MN Nero Marquina</b>  *X = <b>AZ Azul Noche</b>	<b>1041,00</b> <b>1041,00</b> <b>1041,00</b>		

**mandatory: washbasin + framework + shelf or drawer**  
obligatoire: lavabo + structure + encimera o cajón  
obbligatoria: lavabo + estructura + plaque ou tiroir  
obligatorische: Waschbecken + Stahlgestell + Regal oder Schubfach  
обязательное: раковина + Стальной каркас + столешница или ящик

**Technical symbols legend / Simbolos técnicos clave / Légende symboles techniques / Technische Zeichenerklärung / Перечень технических символов**

**with 2 holes prepared 6 holes**  
con 2 agujero predispuesto para 6  
avec 1 trou predisposition 3 à 6 trous  
mit 2-Loch auf 6-Loch durchschlagbar  
два отверстия с возможностью  
выполнения шесть отверстий

























**no tap hole on requeste**  
sin agujero, solo a petición  
sans orifice sur demande  
auf Anfrage ohne Loch  
без отверстия под смеситель  
по запросу

**without overflow**  
sin rebosadero  
sans trop-plein  
ohne Überlauf  
без слива-перелива

# Catino Doppio

drains and siphons / desagües y sifones / les drains et les siphons / Ablaufgarnituren und Siphons / Донные клапаны и сифоны









# cielo



	Product code Artículo Article Artikel Артикул	Net weight <sub>(Kg)</sub> Peso neto Poids net Reingewicht вес нетто	Finishes Acabados Finitions Farbe Отделка	Euro Евро
 <p><b>Universal click/clack drain in CHROME with ceramic lid</b> Válvula universal click/clack Cromado con tapa en cerámica Bonde universelle clic/clac Chromé avec clapet en céramique Universal-Ablaufgarnitur Click-Clack Chrom mit Keramikstopfen Универсальный донный клапан click/clack хром с керамической крышкой</p>	PIL01(X)*	0,40	 <b>Gloss White</b>	<b>95,00</b>
			 <b>Le Terre di Cielo</b>	<b>139,00</b>
			 <b>Le Acque di Cielo</b>	<b>139,00</b>
 <p><b>Universal click/clack drain in BLACK MATT finish with ceramic lid</b> Válvula universal click/clack Negro Matt con tapa en cerámica Bonde universelle clic/clac Noir Mat avec clapet en céramique Universal-Ablaufgarnitur Click-Clack Matt Schwarz mit Keramikstopfen Универсальный донный клапан click/clack черный матовый с керамической крышкой</p>	PIL01NM(X)*	0,40	 <b>Gloss White</b>	<b>120,00</b>
			 <b>Le Terre di Cielo</b>	<b>169,00</b>
			 <b>Le Acque di Cielo</b>	<b>169,00</b>
 <p><b>Universal click/clack drain in CEMENTO finish with ceramic lid</b> Válvula universal click/clack Cemento con tapa en cerámica Bonde universelle clic/clac Cemento avec clapet en céramique Universal-Ablaufgarnitur Click-Clack Cement mit Keramikstopfen Универсальный донный Cemento click/clack с керамической крышкой</p>	PIL01CM(X)*	0,40	 <b>Gloss White</b>	<b>120,00</b>
			 <b>Le Terre di Cielo</b>	<b>169,00</b>
			 <b>Le Acque di Cielo</b>	<b>169,00</b>
 <p><b>Universal click/clack drain in BRONZE with ceramic lid</b> Válvula universal click/clack Bronce con tapa en cerámica Bonde universelle clic/clac Bronze avec clapet en céramique Universal-Ablaufgarnitur Click-Clack Bronze mit Keramikstopfen Универсальный донный клапан click/clack бронза с керамической крышкой</p>	PIL01BR(X)*	0,40	 <b>Gloss White</b>	<b>135,00</b>
			 <b>Le Terre di Cielo</b>	<b>182,00</b>
			 <b>Le Acque di Cielo</b>	<b>182,00</b>
 <p><b>CHROMED siphon</b> Sifone Cromado \ Siphon Chromé \ Siphon Verchromt \ сифон Chrome</p>	SISP	0,93	 <b>Chrome</b>	<b>133,00</b>
 <p><b>MATT BLACK siphon</b> Sifone Negro Mate \ Siphon Noir Mat \ Siphon Schwarz Matt \ Сифон Черный матовый</p>	SIFN	0,93	 <b>Matt Black</b>	<b>194,00</b>
 <p><b>CEMENTO siphon</b> Sifone Cemento \ Siphon Cemento \ Siphon Cemento \ сифон Cemento</p>	SIFCM	0,93	 <b>Cemento</b>	<b>194,00</b>
 <p><b>BRONZE siphon</b> Sifone Bronce \ Siphon Bronze \ Siphon Bronze \ бронза сифон</p>	SIFBR	0,93	 <b>Bronze</b>	<b>220,00</b>

With the installation of the drawer, we recommend matching it with our SISP - SIFN - SIFCM - SIFBR siphons/traps | Con la instalación del cajón aconsejamos de combinar nuestros sifones SISP - SIFN - SIFCM - SIFBR | Terre di Cielo disponibles pour les lavabos et le plan en céramique | Bei Montage der Schublade empfehlen wir unsere Siphons SISP - SIFN - SIFCM - SIFBR / При установке ящика рекомендуем сочетать наши сифоны SISP - SIFN - SIFCM - SIFBR

- Le Terre di Cielo  TL - Talco  PM - Pomice  BR - Brina  BA - Basalto  LV - Lavagna  CM - Cemento  FN - Fango  CA - Cacao
-  AN - Arenaria  AV - Avena  LN - Lino  AG - Agave  MU - Muschio  PL - Polvere  CP - Cipria  CN - Canapa
- Le Acque di Cielo  OL - Oltremare  SM - Smeraldo  AL - Alga  CO - Corallo  NI - Ninfea  AM - Anemone

\* Terre di Cielo laquering available for drawer and shelf / lacados Terre di Cielo disponibles para cajones y encimeras / laquages Terre di Cielo disponibles pour le tiroir et le plan | Für Schublade und Platte erhältliche Lackierungen Terre di Cielo / крашенная отделка Terre di Cielo доступна для ящика и столешницы

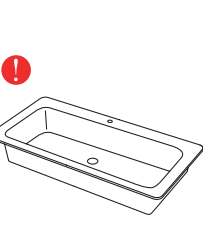
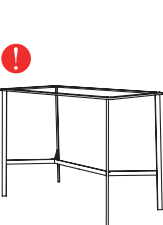
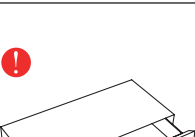
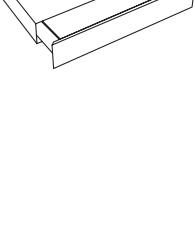
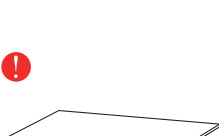
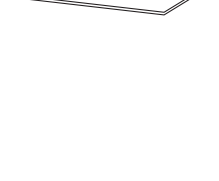
-  TL - Talco  PM - Pomice  BR - Brina  AN - Arenaria  AV - Avena
-  CM - Cemento  BA - Basalto  MU - Muschio

	<b>Size (cm)</b> Medidas Dimensions Maße Размеры	<b>Product code</b> Artículo Article Artikel Артикул	<b>Net weight (Kg)</b> Peso neto Poids net Reingewicht вес нетто	<b>Finishes</b> Acabados Finitions Farbe Отделка	<b>Euro</b> Евро	<b>Pz.</b> шт. pallet Italia	<b>Pz.</b> шт. pallet Cont.
 <p><b>Ceramic washbasin with 1 hole</b>                      Lavabo de cerámica monoagujero                      Lavabo en céramique avec un trou                      Waschbecken aus Keramik mit 1 Hahnloch                      Керамическая раковина на одно отверстие</p>	110 x 58,5	CALAR(X)*  CALARSF(X)* no tap hole sin agujero - sans orifice - ohne Loch без отверстия	35,00	● <b>Gloss White</b>  ● <b>Le Terre di Cielo</b>  ● <b>Le Acque di Cielo</b>	920,00		
 <p><b>Steel framework</b>                      Estructura de acero                      Structure en acier                      Stahlgestell                      Стальной каркас</p>	110 x 58,5	CASTD(X)*	23,50	● *X = NM <b>Matt Black</b>  ● *X = BZ <b>Brushed Bronze</b>  ● *X = CM <b>Cemento</b>  ● <b>Le Acque di Cielo</b>	1157,00	1620,00	1157,00
 <p><b>Lacquered drawer</b>                      Cajón lacado                      Tiroir laqué                      Schubfach lackiert                      Крашенный ящик</p>	100 x 46 x 16,8h	CACDL(X)*	24,50	● <b>Le Terre di Cielo*</b>	1132,00		
 <p><b>Drawer in wooden finish</b>                      Cajón de madera                      Tiroir en bois                      Holzschubfach                      Ящик с отделкой натуральным шпоном</p>	100 x 46 x 16,8h	CACDE(X)*	24,50	<b>EsSENze</b> ● *X = RN - Rovere Naturale ● *X = RS - Rovere Sbiancato ● *X = RO - Rovere Nero ● *X = RG - Rovere Grigio ● *X = EU - Eucalipto	1273,00	1503,00	
 <p><b>Lacquered shelf</b>                      Encimera lacada                      Plan en bois laqué                      Holzregal lackiert                      крашенная столешница</p>	100 x 46 x 1,8h	CAPIDL(X)*	8,00	● <b>Le Terre di Cielo*</b>	368,00		
 <p><b>Shelf in wooden finish</b>                      Encimera de madera                      Plan en bois                      Holzregal                      столешница с отделкой натуральным шпоном</p>	100 x 46 x 1,8h	CAPIDE(X)*	8,00	<b>EsSENze</b> ● *X = RN - Rovere Naturale ● *X = RS - Rovere Sbiancato ● *X = RO - Rovere Nero ● *X = RG - Rovere Grigio ● *X = EU - Eucalipto	521,00	588,00	
 <p><b>Marble shelf</b>                      Encimera en mármol                      Plan en marbre                      Marmor Regal                      Мраморная столешница</p>	100 x 44 x 1,8h	CAPIDM(X)*	25,00	● *X = MB <b>Bianco Carrara</b> ● *X = MN <b>Nero Marquina</b> ● *X = AZ <b>Azul Noche</b>	1041,00	1041,00	1041,00

**mandatory: washbasin + framework + shelf or drawer**  
 obligatoire: lavabo + structure + encimera o cajón  
 obligatoria: lavabo + estructura + plaque ou tiroir  
 obligatorische: Waschbecken + Stahlgestell + Regal oder Schubfach  
 обязательное: раковина + Стальной каркас + столешница или ящик

**Technical symbols legend**  
 Símbolos técnicos clave  
 Légende symboles techniques  
 Technische Zeichenerklärung  
 Перечень технических символов



**with 1 hole prepared 5 holes**  
 con 1 agujero predispuerto para 5  
 avec un trou prédisposition à 5 trous  
 mit 1-Loch auf 5-Loch durchschlagbar  
 одно отверстие с возможностью выполнения 5 отверстий

























**no tap hole on request**  
 sin agujero, solo a petición  
 sans orifice sur demande  
 auf Anfrage ohne Loch  
 без отверстия под смеситель по запросу

**without overflow**  
 sin rebosadero  
 sans trop-plein  
 ohne Überlauf  
 без слива-перелива

# Catino Rettangolare

# cielo









drains and siphons / desagües y sifones / les drains et les siphons / Ablaufgarnituren und Siphons / Донные клапаны и сифоны

	Product code Artículo Article Artikel Артикул	Net weight <sub>(Kg)</sub> Peso neto Poids net Reingewicht вес нетто	Finishes Acabados Finitions Farbe Отделки	Euro Евро
 <p><b>Universal click/clack drain in CHROME with ceramic lid</b> Válvula universal click/clack Cromado con tapa en cerámica Bonde universelle clic/clac Chromé avec clapet en céramique Universal-Ablaufgarnitur Click-Clack Chrom mit Keramikstopfen Универсальный донный клапан click/clack хром с керамической крышкой</p>	PIL01(X)*	0,40	 <b>Gloss White</b>	<b>95,00</b>
			 <b>Le Terre di Cielo</b>	<b>139,00</b>
			 <b>Le Acque di Cielo</b>	<b>139,00</b>
 <p><b>Universal click/clack drain in BLACK MATT finish with ceramic lid</b> Válvula universal click/clack Negro Matt con tapa en cerámica Bonde universelle clic/clac Noir Mat avec clapet en céramique Universal-Ablaufgarnitur Click-Clack Matt Schwarz mit Keramikstopfen Универсальный донный клапан click/clack черный матовый с керамической крышкой</p>	PIL01NM(X)*	0,40	 <b>Gloss White</b>	<b>120,00</b>
			 <b>Le Terre di Cielo</b>	<b>169,00</b>
			 <b>Le Acque di Cielo</b>	<b>169,00</b>
 <p><b>Universal click/clack drain in CEMENTO finish with ceramic lid</b> Válvula universal click/clack Cemento con tapa en cerámica Bonde universelle clic/clac Cemento avec clapet en céramique Universal-Ablaufgarnitur Click-Clack Cement mit Keramikstopfen Универсальный донный Cemento click/clack с керамической крышкой</p>	PIL01CM(X)*	0,40	 <b>Gloss White</b>	<b>120,00</b>
			 <b>Le Terre di Cielo</b>	<b>169,00</b>
			 <b>Le Acque di Cielo</b>	<b>169,00</b>
 <p><b>Universal click/clack drain in BRONZE with ceramic lid</b> Válvula universal click/clack Bronce con tapa en cerámica Bonde universelle clic/clac Bronce avec clapet en céramique Universal-Ablaufgarnitur Click-Clack Bronze mit Keramikstopfen Универсальный донный клапан click/clack бронза с керамической крышкой</p>	PIL01BR(X)*	0,40	 <b>Gloss White</b>	<b>135,00</b>
			 <b>Le Terre di Cielo</b>	<b>182,00</b>
			 <b>Le Acque di Cielo</b>	<b>182,00</b>
 <p><b>CHROMED siphon</b> Sifone Cromado \ Siphon Chromé \ Siphon Verchromt \ сифон Chrome</p>	SISP	0,93	 <b>Chrome</b>	<b>133,00</b>
 <p><b>MATT BLACK siphon</b> Sifone Negro Mate \ Siphon Noir Mat \ Siphon Schwarz Matt \ Сифон Черный матовый</p>	SIFN	0,93	 <b>Matt Black</b>	<b>194,00</b>
 <p><b>CEMENTO siphon</b> Sifone Cemento \ Siphon Cemento \ Siphon Cemento \ сифон Cemento</p>	SIFCM	0,93	 <b>Cemento</b>	<b>194,00</b>
 <p><b>BRONZE siphon</b> Sifone Bronce \ Siphon Bronce \ Siphon Bronze \ бронза сифон</p>	SIFBR	0,93	 <b>Bronze</b>	<b>220,00</b>

With the installation of the drawer, we recommend matching it with our SISP - SIFN - SIFCM - SIFBR siphons/traps / Con la instalación del cajón aconsejamos de combinar nuestros sifones SISP- SIFN-SIFCM-SIFBR / Terre di Cielo disponibles pour les lavabos et le plan en céramique / Bei Montage der Schublade empfehlen wir unsere Siphons SISP - SIFN - SIFCM - SIFBR / При установке ящика рекомендуем сочетать наши сифоны SISP - SIFN - SIFCM - SIFBR

- Le Terre di Cielo  TL - Talco  PM - Pomice  BR - Brina  BA - Basalto  LV - Lavagna  CM - Cemento  FN - Fango  CA - Cacao
-  AN - Arenaria  AV - Avena  LN - Lino  AG - Agave  MU - Muschio  PL - Polvere  CP - Cipria  CN - Canapa
- Le Acque di Cielo  OL - Oltremare  SM - Smeraldo  AL - Alga  CO - Corallo  NI - Ninfea  AM - Anemone

\* Terre di Cielo laquering available for drawer and shelf / lacados Terre di Cielo disponibles para cajones y encimeras / laquages Terre di Cielo disponibles pour le tiroir et le plan / Für Schublade und Platte erhältliche Lackierungen Terre di Cielo / крашеная отделка Terre di Cielo доступна для ящика и столешницы

-  TL - Talco  PM - Pomice  BR - Brina  AN - Arenaria  AV - Avena
-  CM - Cemento  BA - Basalto  MU - Muschio





	Size (cm)	Product code	Net weight (Kg)	Finishes	Euro	Pz.	Pz.
	Medidas Dimensions Maße Размеры	Artículo Article Artikel Артикул	Peso neto Poids net Reingewicht вес нетто	Acabados Finitions Farbe Отделка	Евро	шт. pallet Italia	шт. pallet Cont.
 <p><b>Mirror single</b> Espejo de una cara Miroir simple face Spiegel einseitig beidseitig Зеркало одностороннее</p> <p><b>Mirror (double sided)</b> Espejo (doble cara) Miroir (double face) Spiegel (beidseitig) Зеркало (двухстороннее)</p> <p><b>Leather belt</b> Cinta de cuero Sangle en cuir Lederband кожаным ремнем</p>	∅60	SPMFC(X)*	7,50	<b>Frame / cornisa / cadre / Rahmen / Р амка</b> ● *X = <b>NM - Matt Black</b> ● *X = <b>CM - Cemento</b> ● *X = <b>MS - Multistrati</b>	1098,00 1098,00 1155,00		
	∅60	SPBFC(X)*	10,00	<b>Frame / cornisa / cadre / Rahmen / Р амка</b> ● *X = <b>NM - Matt Black</b> ● *X = <b>CM - Cemento</b> ● *X = <b>MS - Multistrati</b>	1248,00 1248,00 1306,00		
	h58	SPCC58(X)*	0,40	● *X = <b>NE - Matt Black</b> ○ *X = <b>BI - Matt White</b> ● *X = <b>NA - Naturale</b>	659,00 659,00 659,00		
	h78	SPCC78(X)*	0,50	● *X = <b>NE - Matt Black</b> ○ *X = <b>BI - Matt White</b> ● *X = <b>NA - Naturale</b>	677,00 677,00 677,00		
	h108	SPCC108(X)*	0,60	● *X = <b>NE - Matt Black</b> ○ *X = <b>BI - Matt White</b> ● *X = <b>NA - Naturale</b>	693,00 693,00 693,00		

**mandatory: mirror + belt**

obligatoire: espejo + cuero  
obligatoria: mirror + sangle  
obligatorische: Spiegel + Lederband  
обязательное: Зеркало + кожаным

**Technical symbols legend**

Simbolos técnicos clave / Légende symboles  
techniques / Technische Zeichenerklärung /  
Перечень технических символов

 **ceiling installation**  
installation en et techo  
installation au plafond  
Deckenmontage  
потолочная установка





	<b>Size (cm)</b> Medidas Dimensions Maße Размеры	<b>Product code</b> Artículo Article Artikel Артикул	<b>Net weight (Kg)</b> Peso neto Poids net Reingewicht вес нетто	<b>Finishes</b> Acabados Finitions Farbe Отделки	<b>Euro</b> Евро
<b>ROUND BOX</b> <b>Round mirror cabinet with lacquered box</b> Espejo contenedor redondo con borde lacado Meuble à miroir rond avec corps laqué Spiegelschrank rund Gestell lackiert Зеркальный шкафчик круглый с крашенной рамой	Ø90 x 12	CASPCT(x)*	27,50	<ul style="list-style-type: none"> <li>● *X = NM - Matt Black</li> <li>● *X = CM - Cemento</li> <li>● *X = BZ -Brushed Bronze</li> <li>● Le Acque di Cielo</li> </ul>	1743,00 1959,00 1959,00 2543,00
<b>OVAL BOX</b> <b>Oval mirror cabinet with lacquered box</b> Espejo contenedor ovalado con borde lacado Meuble à miroir ovale avec corps laqué Spiegelschrank oval, Gestell lackiert Зеркальный шкафчик овальный с крашенной рамой	50 x 12 x 90 h	CASPCO(x)*	17,00	<ul style="list-style-type: none"> <li>● *X = NM - Matt Black</li> <li>● *X = CM - Cemento</li> <li>● *X = BZ -Brushed Bronze</li> <li>● Le Acque di Cielo</li> </ul>	1338,00 1515,00 1515,00 2153,00
<b>ROUND MIRROR</b> <b>Round mirror with lacquered frame</b> Espejo redondo con borde lacado Miroir rond avec corps laqué Spiegel rund, Gestell lackiert Зеркало круглое с крашенной рамой	Ø120 x 4	CASPT(x)*	24,00	<ul style="list-style-type: none"> <li>● *X = NM - Matt Black</li> <li>● *X = CM - Cemento</li> <li>● *X = BZ - Brushed Bronze</li> </ul>	1284,00 1433,00 1433,00
<b>OVAL MIRROR</b> <b>Oval mirror with lacquered frame</b> Espejo ovalado con borde lacado Miroir oval avec corps laqué Spiegel oval, Gestell lackiert Зеркало овальное с крашенной рамой	50 x 4 x 90 h	CASPO(x)*	13,00	<ul style="list-style-type: none"> <li>● *X = NM - Matt Black</li> <li>● *X = CM - Cemento</li> <li>● *X = BZ - Brushed Bronze</li> </ul>	1014,00 1122,00 1122,00

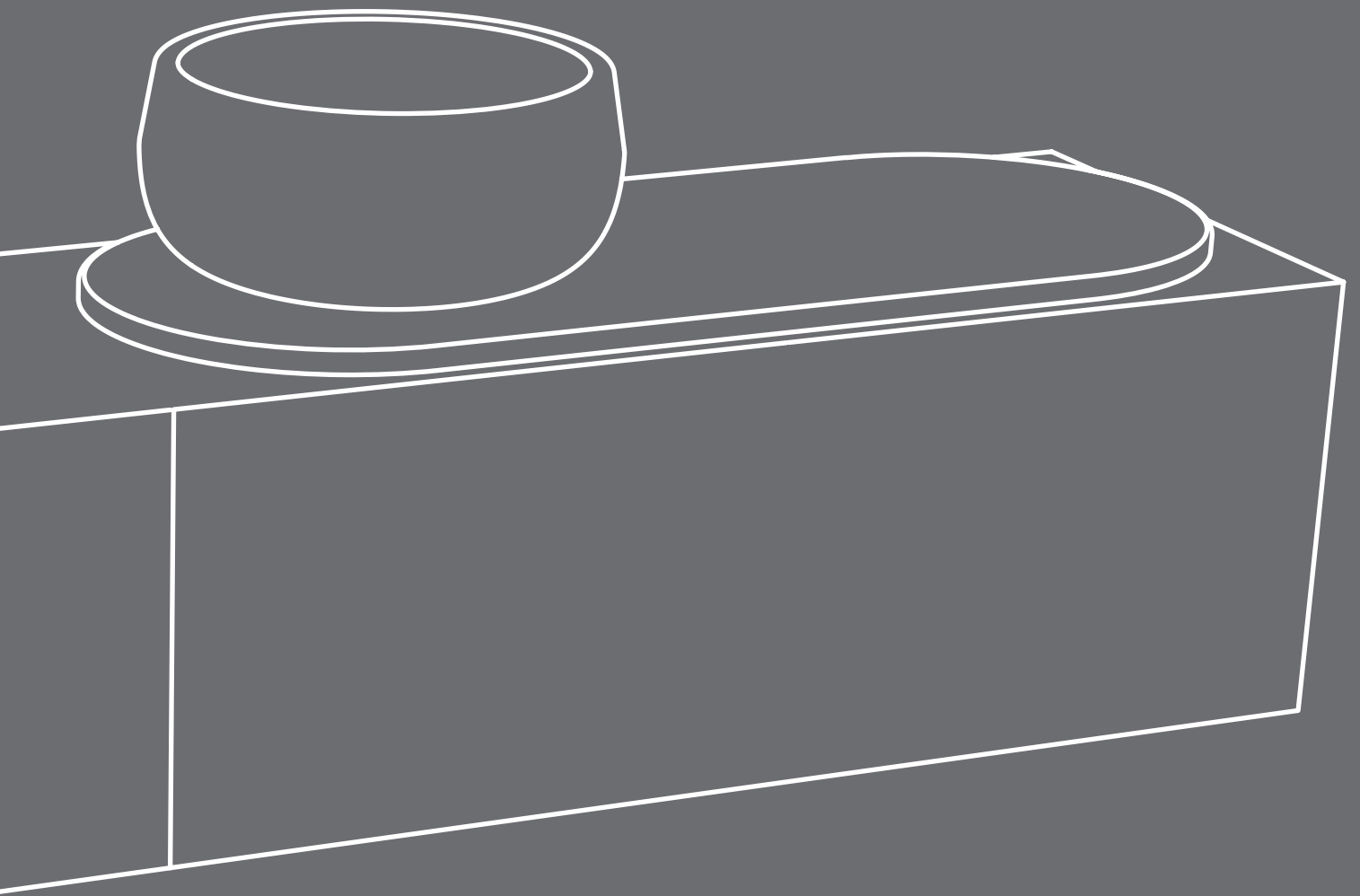

# Delfo

design **Andrea Parisio & Giuseppe Pezzano**

QR code configuratore \ configurator pg. 160

indice collezione \ collection pg. 161 - 163

moduli d'ordine \ order form pg. 165 - 175

listino prezzi \ price list pg. 176 - 194









**Configure the product directly online and send the order to Cielo.**

Configure el producto directamente online y envíe el pedido a Cielo.  
 Configurez le produit directement en ligne et envoyez la commande à Cielo.  
 Konfigurieren Sie Ihr Produkt online und schicken Sie die Bestellung direkt an Cielo.  
 Сконфигурируйте изделие в онлайн и перешлите заказ на фабрику Cielo.

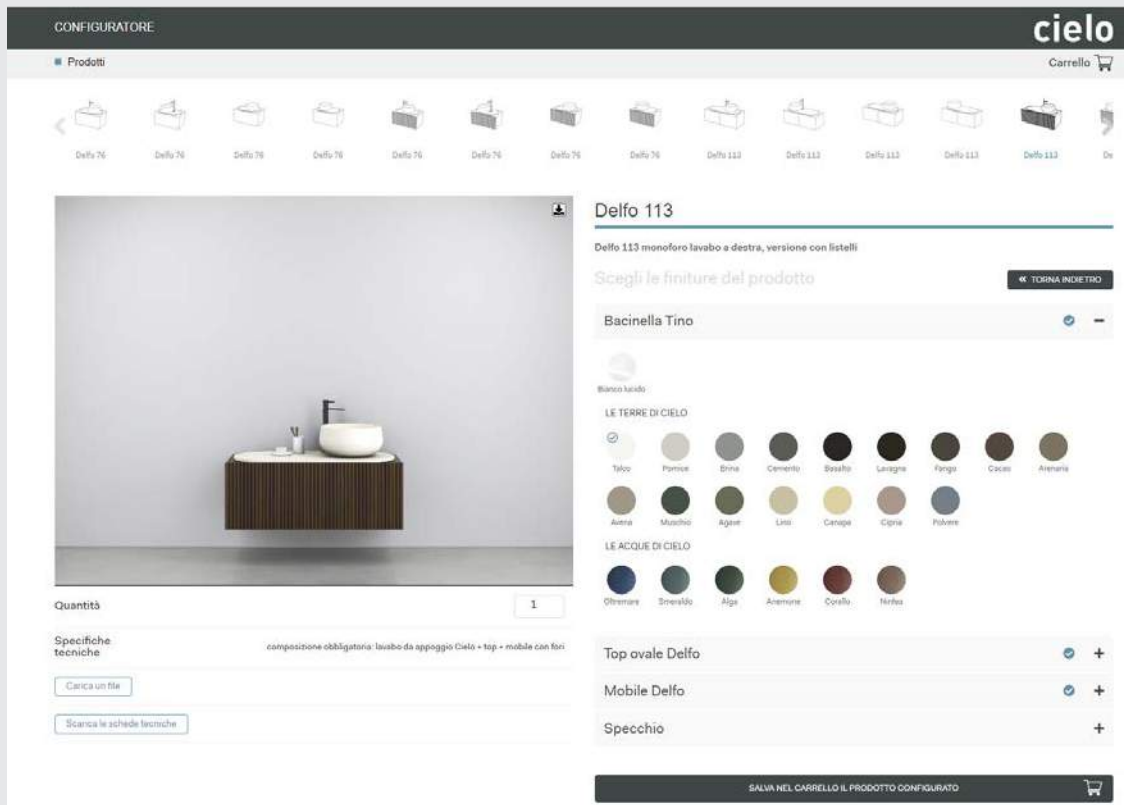

EN

SP

FR

RU



go to the configurator



ir al configurador



lien vers le configurateur

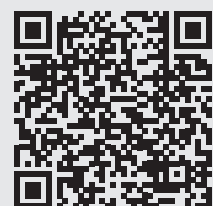

Перейдите в конфигурактор

## Lavabo con mobile / washbasin with cabinet

### DELFO 76

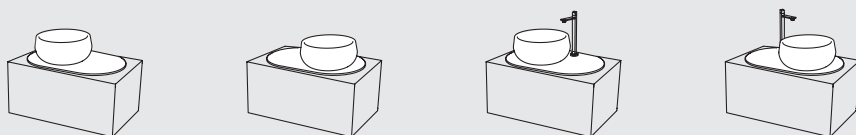

#### LAVABO + TOP OVALE + MOBILE VERSIONE LISCIA 76

Washbasin + oval top + smooth version cabinet 76

76 x 48

pag. 176

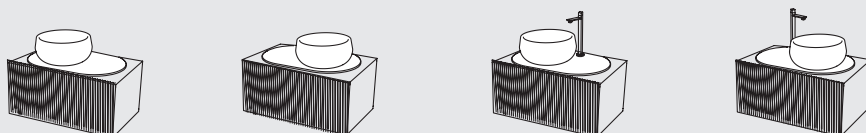

#### LAVABO + TOP OVALE + MOBILE VERSIONE LISTELLI 76

Washbasin + oval top + cabinet with front door in solid triangular wooden strips 76

76 x 50

pag. 176

### DELFO 113

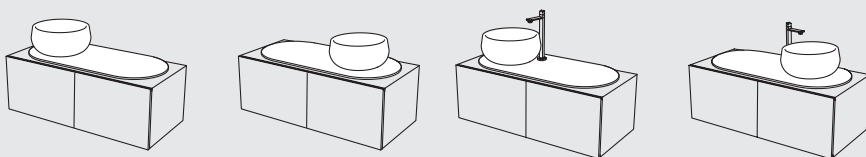

#### LAVABO + TOP OVALE + MOBILE VERSIONE LISCIA 113

Washbasin + oval top + smooth version cabinet 113

113 x 52

pag. 178

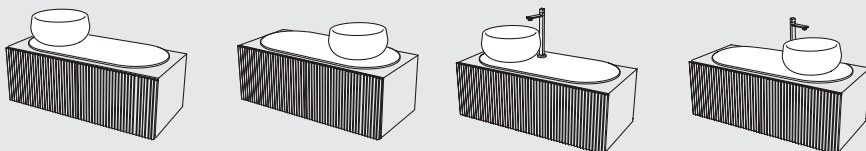

#### LAVABO + TOP OVALE + MOBILE VERSIONE LISTELLI 113

Washbasin + oval top + cabinet with front door in solid triangular wooden strips 113

113 x 52

pag. 178

Lavabo con mobile / washbasin with cabinet

DELFO 152

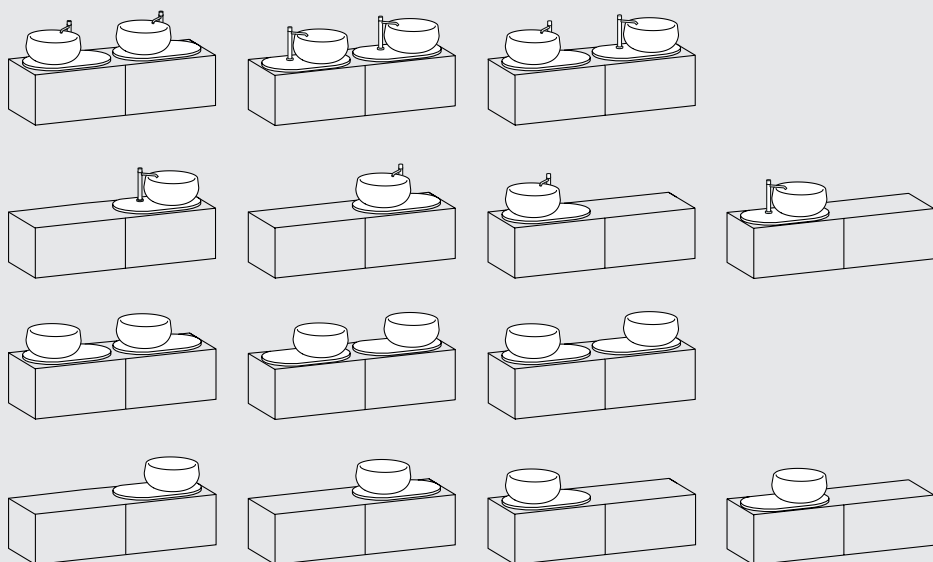

LAVABO + TOP OVALE + MOBILE VERSIONE LISCIA 152

Washbasin + oval top + smooth version cabinet 152

152 x 48

pag. 180

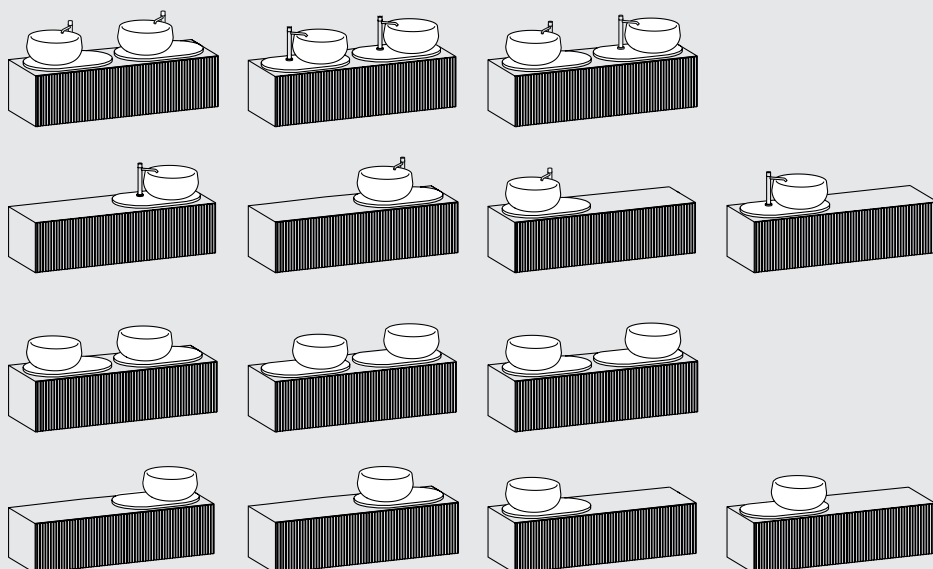

LAVABO + TOP OVALE + MOBILE VERSIONE LISTELLI 152

Washbasin + oval top + cabinet with front door in solid triangular wooden strips 152

152 x 50

pag. 180

Lavabo con mobile / washbasin with cabinet

DELFO 226

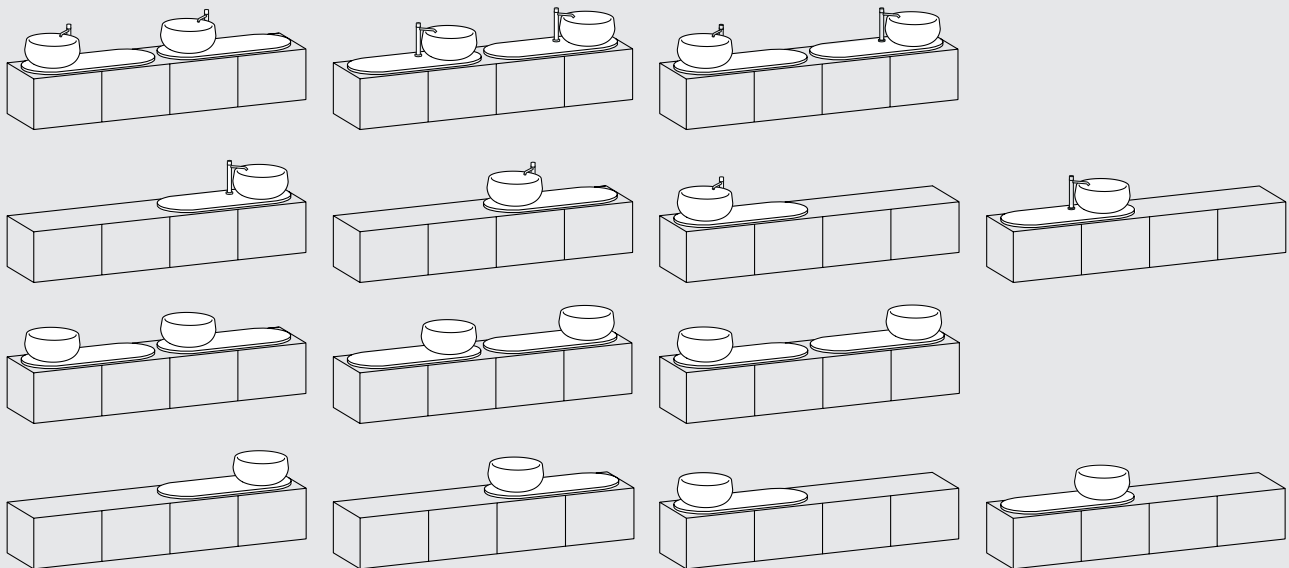

LAVABO + TOP OVALE + MOBILE VERSIONE LISCIA 226

Washbasin + oval top + smooth version cabinet 226  
226 x 52  
pag. 188

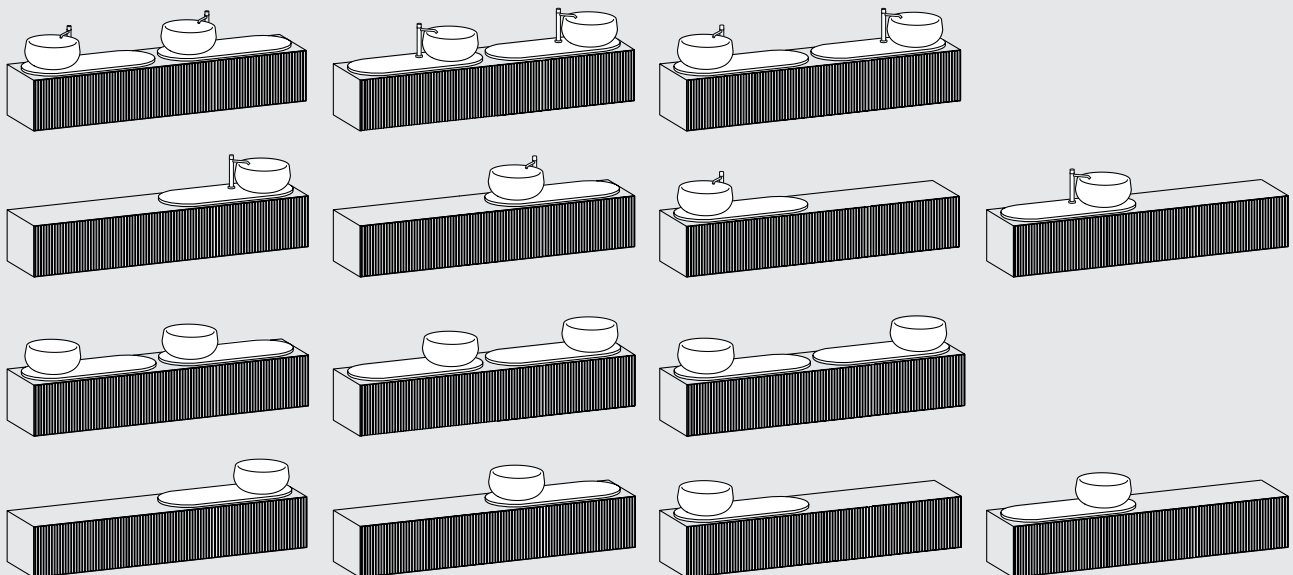

LAVABO + TOP OVALE + MOBILE VERSIONE LISTELLI 226

Washbasin + oval top + cabinet with front door in solid triangular wooden strips 226  
226 x 52  
pag. 188

modelli disponibili / available models

**DELFO**  
collection

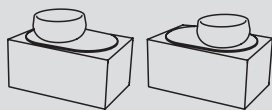

**Delfo 76 mobile con ante frontali lisce**  
Delfo 76 cabinet with smooth front door

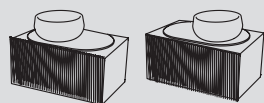

**Delfo 76 mobile con ante frontali in listelli di massello triangolari**  
Delfo 76 cabinet with front door in solid triangular strips



finiture / finishes

**LAVABO E TOP OVALE IN CERAMICA / CERAMIC WASHBASIN AND REVERSIBLE TOP**

**Le Terre di Cielo**



BATO

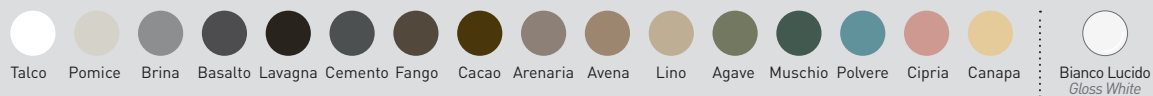

DEPI076

**Le Acque di Cielo**



DEC76L  
DEC76E

**MOBILE IN LEGNO VERSIONE LISCIA / WOODEN CABINET SMOOTH VERSION**

laccature / lacquers

**Le Terre di Cielo**

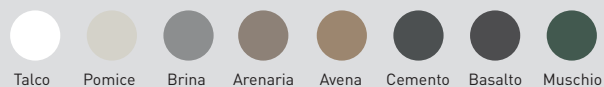

DEC76LSF  
DEC76ESF

**essenze / wooden finishes**

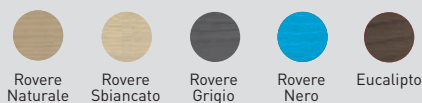

DECD76E

**MOBILE IN LEGNO VERSIONE CON LISTELLI/ WOODEN CABINET WITH LATHS**

essenze / wooden finishes

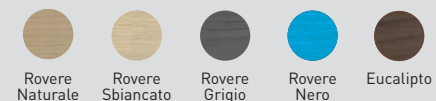

DECD76ESF

note tecniche lavabo / washbasin technical notes



senza troppopieno  
without overflow



con tutti i lati smaltati  
all enamelled sides



installazione da appoggio  
on top installation



senza foro  
without hole



composizione obbligatoria: lavabo da appoggio Cielo + top  
ovale + mobile con fori  
mandatory combination: on top Cielo washbasin + top + cabinet  
with holes

CLIENTE/client:  ORD. REF.:

QUANTITA'/quantity:  EMAIL:

art. **BATO**

**FINITURE LAVABO**

WASHBASIN SHELF FINISHES

Bianco/white - glossy

Le Terre di Cielo

- |                                    |                                     |
|------------------------------------|-------------------------------------|
| <input type="radio"/> TL - Talco   | <input type="radio"/> AN - Arenaria |
| <input type="radio"/> PM - Pomice  | <input type="radio"/> AV - Avena    |
| <input type="radio"/> BR - Brina   | <input type="radio"/> LN - Lino     |
| <input type="radio"/> BA - Basalto | <input type="radio"/> AG - Agave    |
| <input type="radio"/> LV - Lavagna | <input type="radio"/> MU - Muschio  |
| <input type="radio"/> CM - Cemento | <input type="radio"/> PL - Polvere  |
| <input type="radio"/> FN - Fango   | <input type="radio"/> CP - Cipria   |
| <input type="radio"/> CA - Cacao   | <input type="radio"/> CN - Canapa   |

Le Acque di Cielo

- |                                      |                                    |
|--------------------------------------|------------------------------------|
| <input type="radio"/> OL - Oltremare | <input type="radio"/> CO - Corallo |
| <input type="radio"/> SM - Smeraldo  | <input type="radio"/> NI - Ninfea  |
| <input type="radio"/> AL - Alga      | <input type="radio"/> AM - Anemone |

art. **DEPIO76**

**FINITURE TOP OVALE**

OVAL TOP FINISHES

Bianco/white - glossy

Le Terre di Cielo

- |                                    |                                     |
|------------------------------------|-------------------------------------|
| <input type="radio"/> TL - Talco   | <input type="radio"/> AN - Arenaria |
| <input type="radio"/> PM - Pomice  | <input type="radio"/> AV - Avena    |
| <input type="radio"/> BR - Brina   | <input type="radio"/> LN - Lino     |
| <input type="radio"/> BA - Basalto | <input type="radio"/> AG - Agave    |
| <input type="radio"/> LV - Lavagna | <input type="radio"/> MU - Muschio  |
| <input type="radio"/> CM - Cemento | <input type="radio"/> PL - Polvere  |
| <input type="radio"/> FN - Fango   | <input type="radio"/> CP - Cipria   |
| <input type="radio"/> CA - Cacao   | <input type="radio"/> CN - Canapa   |

Le Acque di Cielo

- |                                      |                                    |
|--------------------------------------|------------------------------------|
| <input type="radio"/> OL - Oltremare | <input type="radio"/> CO - Corallo |
| <input type="radio"/> SM - Smeraldo  | <input type="radio"/> NI - Ninfea  |
| <input type="radio"/> AL - Alga      | <input type="radio"/> AM - Anemone |

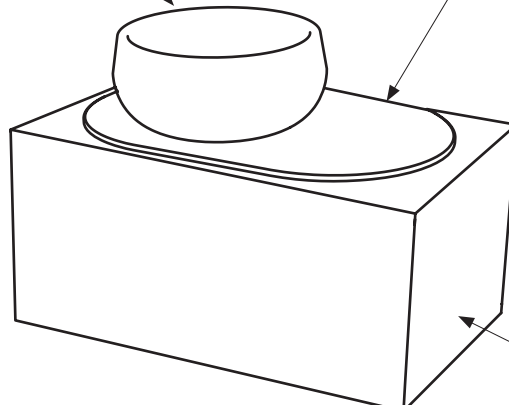

art. **DECD76E**

**FINITURE MOBILE IN LEGNO CON ANTA FRONTALE IN LISTELLI**

WOODEN CABINET FINISHES WITH FRONT DOOR IN SOLID WOODEN STRIPS

essenze legno/wood essences

- RO - Rovere Nero
- RG - Rovere Grigio
- RS - Rovere Sbiancato
- RN - Rovere Naturale
- EU - Eucalipto

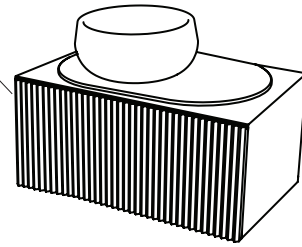

art. **DEC76L / art. DEC76E**

**FINITURE MOBILE IN LEGNO VERSIONE LISCIA**

WOODEN CABINET FINISHES - SMOOTH VERSION

laccature/laquerings

- TL - Talco
- PM - Pomice
- BR - Brina
- AN - Arenaria
- AV - Avena
- CM - Cemento
- BA - Basalto
- MU - Muschio

essenze legno/wood essences

- RO - Rovere Nero
- RG - Rovere Grigio
- RS - Rovere Sbiancato
- RN - Rovere Naturale
- EU - Eucalipto

**N.B. Indicare obbligatoriamente la posizione del foro rubinetto sul top ovale**  
It is mandatory to specify the tap hole position on the oval top

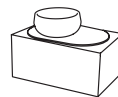
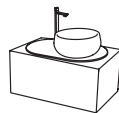
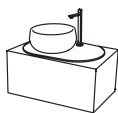

**FORO RUBINETTO DX**  
RIGHT TAP HOLE



**FORO RUBINETTO SX**  
LEFT TAP HOLE

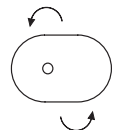

**SENZA FORO RUBINETTO (foro lavabo dx/sx, top ovale reversibile) / NO TAP HOLE (washbasin hole right/left, oval top ceramic reversible)**

**DATA**  
DATE

**FIRMA DEL CLIENTE**  
SIGNATURE

ATTENZIONE:  
La rappresentazione delle finiture è puramente indicativa. Verificare le finiture con le relative cartelle.

Ogni oggetto possiede la peculiarità di essere elaborato secondo principi puramente tradizionali, in modo da garantirne l'assoluta originalità ed unicità. Le eventuali piccole variazioni di colore, tono o venature fra gli articoli sono da considerarsi pregi e non difetti, in quanto garanzia della fattura manuale del prodotto, che fa di ogni oggetto Cielo un pezzo unico ed esclusivo, lontano dall'omologazione industriale. In fase d'ordine si intendono, pertanto, accettate tali tolleranze che non possono dare adito a contestazioni di alcun genere.

Verificare sempre le disponibilità e i tempi di consegna con il commerciale.

ATTENTION:  
The representation of the finishes is merely indicative. Please choose the finishes using the folders.

Every item possesses that particular feature of being processed according to purely traditional principles that guarantee its absolute originality and uniqueness. The small variations in colour, hues or streaks on the items are to be considered as qualities and not defects, since they warranty the handcrafted processing which makes each Cielo item a unique and exclusive piece that cannot be compared to industrial standardization. When making the order, the client implicitly accepts those various features that may give rise to claims of any sort.

Always check the availability and delivery time with the commercial department.





**modelli disponibili / available models**

**DELFO**  
collection

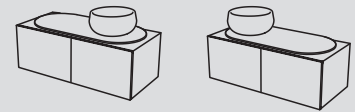

**Delfo 113 mobile con ante frontali lisce**  
Delfo 113 cabinet with smooth front door

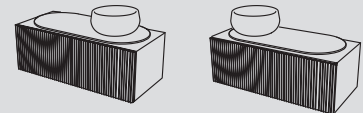

**Delfo 113 mobile con ante frontali in listelli di massello triangolari**  
Delfo 113 cabinet with front door in solid triangular strips

**finiture / finishes**

**LAVABO E TOP OVALE IN CERAMICA / CERAMIC WASHBASIN AND REVERSIBLE TOP**

**Le Terre di Cielo**

Bianco Lucido *Gloss White* Talco Pomice Brina Basalto Lavagna Cemento Fango Cacao Arenaria Avena Lino Agave Muschio Polvere Cipria Canapa

**Le Acque di Cielo**

Oltremare Smeraldo Alga Corallo Ninfea Anemone

BATO

DEPIO

**MOBILE IN LEGNO VERSIONE LISCIA / WOODEN CABINET SMOOTH VERSION**

**laccature / lacquers**

**Le Terre di Cielo**

Talco Pomice Brina Arenaria Avena Cemento Basalto Muschio

**essenze / wooden finishes**

Rovere Naturale Rovere Sbiancato Rovere Grigio Rovere Nero Eucalipto

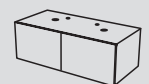

DECL  
DECE

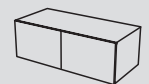

DECLSF  
DECESF

**MOBILE IN LEGNO VERSIONE CON LISTELLI / WOODEN CABINET WITH LATHS**

**essenze / wooden finishes**

Rovere Naturale Rovere Sbiancato Rovere Grigio Rovere Nero Eucalipto

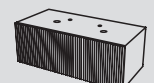

DECDE

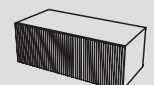

DECDESF

**note tecniche lavabo / washbasin technical notes**

**senza troppopieno**  
without overflow

**con tutti i lati smaltati**  
all enamelled sides

**installazione da appoggio**  
on top installation

**senza foro**  
without hole

**composizione obbligatoria: lavabo da appoggio Cielo + top ovale + mobile con fori**  
mandatory combination: on top Cielo washbasin + top + cabinet with holes

CLIENTE/client:  ORD. REF.:

QUANTITA'/quantity:  EMAIL:

art. **BATO**

**FINITURE LAVABO**

WASHBASIN SHELF FINISHES

Bianco/white - glossy

Le Terre di Cielo

- |                                    |                                     |
|------------------------------------|-------------------------------------|
| <input type="radio"/> TL - Talco   | <input type="radio"/> AN - Arenaria |
| <input type="radio"/> PM - Pomice  | <input type="radio"/> AV - Avena    |
| <input type="radio"/> BR - Brina   | <input type="radio"/> LN - Lino     |
| <input type="radio"/> BA - Basalto | <input type="radio"/> AG - Agave    |
| <input type="radio"/> LV - Lavagna | <input type="radio"/> MU - Muschio  |
| <input type="radio"/> CM - Cemento | <input type="radio"/> PL - Polvere  |
| <input type="radio"/> FN - Fango   | <input type="radio"/> CP - Cipria   |
| <input type="radio"/> CA - Cacao   | <input type="radio"/> CN - Canapa   |

Le Acque di Cielo

- |                                      |                                    |
|--------------------------------------|------------------------------------|
| <input type="radio"/> OL - Oltremare | <input type="radio"/> CO - Corallo |
| <input type="radio"/> SM - Smeraldo  | <input type="radio"/> NI - Ninfea  |
| <input type="radio"/> AL - Alga      | <input type="radio"/> AM - Anemone |

art. **DEPIO**

**FINITURE TOP OVALE**

OVAL TOP FINISHES

Bianco/white - glossy

Le Terre di Cielo

- |                                    |                                     |
|------------------------------------|-------------------------------------|
| <input type="radio"/> TL - Talco   | <input type="radio"/> AN - Arenaria |
| <input type="radio"/> PM - Pomice  | <input type="radio"/> AV - Avena    |
| <input type="radio"/> BR - Brina   | <input type="radio"/> LN - Lino     |
| <input type="radio"/> BA - Basalto | <input type="radio"/> AG - Agave    |
| <input type="radio"/> LV - Lavagna | <input type="radio"/> MU - Muschio  |
| <input type="radio"/> CM - Cemento | <input type="radio"/> PL - Polvere  |
| <input type="radio"/> FN - Fango   | <input type="radio"/> CP - Cipria   |
| <input type="radio"/> CA - Cacao   | <input type="radio"/> CN - Canapa   |

Le Acque di Cielo

- |                                      |                                    |
|--------------------------------------|------------------------------------|
| <input type="radio"/> OL - Oltremare | <input type="radio"/> CO - Corallo |
| <input type="radio"/> SM - Smeraldo  | <input type="radio"/> NI - Ninfea  |
| <input type="radio"/> AL - Alga      | <input type="radio"/> AM - Anemone |

art. **DECDE**

**FINITURE MOBILE IN LEGNO CON ANTA FRONTALE IN LISTELLI**

WOODEN CABINET FINISHES WITH FRONT DOOR IN SOLID WOODEN STRIPS

essenze legno/wood essences

- |   |
|---|
| <input type="radio"/> RO - Rovere Nero      |
| <input type="radio"/> RG - Rovere Grigio    |
| <input type="radio"/> RS - Rovere Sbiancato |
| <input type="radio"/> RN - Rovere Naturale  |
| <input type="radio"/> EU - Eucalipto        |

art. **DECL / art. DECE**

**FINITURE MOBILE IN LEGNO VERSIONE LISCIA**

WOODEN CABINET FINISHES - SMOOTH VERSION

laccature/laquerings

- |                                     |
|-------------------------------------|
| <input type="radio"/> TL - Talco    |
| <input type="radio"/> PM - Pomice   |
| <input type="radio"/> BR - Brina    |
| <input type="radio"/> AN - Arenaria |
| <input type="radio"/> AV - Avena    |
| <input type="radio"/> CM - Cemento  |
| <input type="radio"/> BA - Basalto  |
| <input type="radio"/> MU - Muschio  |

essenze legno/wood essences

- |   |
|---|
| <input type="radio"/> RO - Rovere Nero      |
| <input type="radio"/> RG - Rovere Grigio    |
| <input type="radio"/> RS - Rovere Sbiancato |
| <input type="radio"/> RN - Rovere Naturale  |
| <input type="radio"/> EU - Eucalipto        |

**N.B. Indicare obbligatoriamente la posizione del foro rubinetto sul top ovale**  
It is mandatory to specify the tap hole position on the oval top

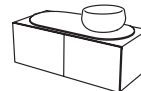
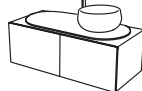

**DATA**  
DATE

**FIRMA DEL CLIENTE**  
SIGNATURE

ATTENZIONE:  
La rappresentazione delle finiture è puramente indicativa. Verificare le finiture con le relative cartelle.

Ogni oggetto possiede la peculiarità di essere elaborato secondo principi puramente tradizionali, in modo da garantirne l'assoluta originalità ed unicità. Le eventuali piccole variazioni di colore, tono o venature fra gli articoli sono da considerarsi pregi e non difetti, in quanto garanzia della fattura manuale del prodotto, che fa di ogni oggetto Cielo un pezzo unico ed esclusivo, lontano dall'omologazione industriale. In fase d'ordine si intendono, pertanto, accettate tali tolleranze che non possono dare adito a contestazioni di alcun genere.

Verificare sempre le disponibilità e i tempi di consegna con il commerciale.

ATTENTION:  
The representation of the finishes is merely indicative. Please choose the finishes using the folders.

Every item possesses that particular feature of being processed according to purely traditional principles that guarantee its absolute originality and uniqueness. The small variations in colour, hues or streaks on the items are to be considered as qualities and not defects, since they warranty the handcrafted processing which makes each Cielo item a unique and exclusive piece that cannot be compared to industrial standardization. When making the order, the client implicitly accepts those various features that may give rise to claims of any sort.

Always check the availability and delivery time with the commercial department.



**modelli disponibili / available models**

**DELFO**  
collection

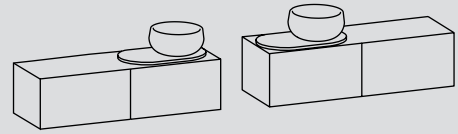

**Delfo 152 mobile con ante frontali lisce**  
Delfo 152 cabinet with smooth front door

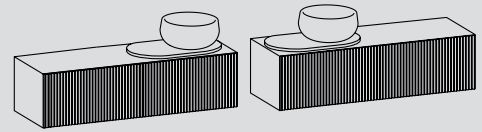

**Delfo 152 mobile con ante frontali in listelli di massello triangolari**  
Delfo 152 cabinet with front door in solid triangular strips

**finiture / finishes**

**LAVABO E TOP OVALE IN CERAMICA / CERAMIC WASHBASIN AND REVERSIBLE TOP**



**MOBILE IN LEGNO VERSIONE LISCIA / WOODEN CABINET SMOOTH VERSION**

**laccature / lacquers**

DEC152DXL / DEC152DXE

**Le Terre di Cielo**



**essenze / wooden finishes**

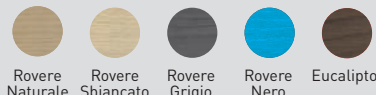

DEC152SXL / DEC152SXE

DEC152LSF / DEC152ESF

**MOBILE IN LEGNO VERSIONE CON LISTELLI / WOODEN CABINET WITH LATHS**

**essenze / wooden finishes**

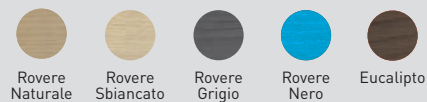





DECD152DXE

DECD152SXE

DECD152ESF

**note tecniche lavabo / washbasin technical notes**

-   
**senza troppopieno**  
without overflow
-   
**con tutti i lati smaltati**  
all enamelled sides
-   
**installazione da appoggio**  
on top installation
-   
**senza foro**  
without hole
-   
**composizione obbligatoria: lavabo da appoggio Cielo + top ovale + mobile con fori**  
*mandatory combination: on top Cielo washbasin + top + cabinet with holes*

# Modulo Ordine Delfo 152 con un lavabo

## Delfo 152 with one washbasin with Order Form

# cielo

CLIENTE/client:  ORD. REF.:

QUANTITA'/quantity:  EMAIL:

art. **BATO**

### FINITURE LAVABO

WASHBASIN SHELF FINISHES

Bianco/white - glossy

Le Terre di Cielo

- |                                    |                                     |
|------------------------------------|-------------------------------------|
| <input type="radio"/> TL - Talco   | <input type="radio"/> AN - Arenaria |
| <input type="radio"/> PM - Pomice  | <input type="radio"/> AV - Avena    |
| <input type="radio"/> BR - Brina   | <input type="radio"/> LN - Lino     |
| <input type="radio"/> BA - Basalto | <input type="radio"/> AG - Agave    |
| <input type="radio"/> LV - Lavagna | <input type="radio"/> MU - Muschio  |
| <input type="radio"/> CM - Cemento | <input type="radio"/> PL - Polvere  |
| <input type="radio"/> FN - Fango   | <input type="radio"/> CP - Cipria   |
| <input type="radio"/> CA - Cacao   | <input type="radio"/> CN - Canapa   |

Le Acque di Cielo

- |                                      |                                    |
|--------------------------------------|------------------------------------|
| <input type="radio"/> OL - Oltremare | <input type="radio"/> CO - Corallo |
| <input type="radio"/> SM - Smeraldo  | <input type="radio"/> NI - Ninfea  |
| <input type="radio"/> AL - Alga      | <input type="radio"/> AM - Anemone |

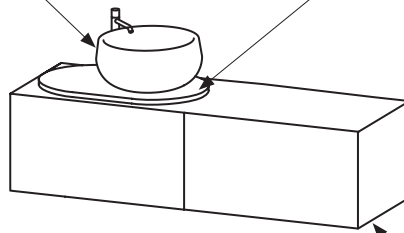

art. **DEPIO76**

### FINITURE TOP OVALE

OVAL TOP FINISHES

Bianco/white - glossy

Le Terre di Cielo

- |                                    |                                     |
|------------------------------------|-------------------------------------|
| <input type="radio"/> TL - Talco   | <input type="radio"/> AN - Arenaria |
| <input type="radio"/> PM - Pomice  | <input type="radio"/> AV - Avena    |
| <input type="radio"/> BR - Brina   | <input type="radio"/> LN - Lino     |
| <input type="radio"/> BA - Basalto | <input type="radio"/> AG - Agave    |
| <input type="radio"/> LV - Lavagna | <input type="radio"/> MU - Muschio  |
| <input type="radio"/> CM - Cemento | <input type="radio"/> PL - Polvere  |
| <input type="radio"/> FN - Fango   | <input type="radio"/> CP - Cipria   |
| <input type="radio"/> CA - Cacao   | <input type="radio"/> CN - Canapa   |

Le Acque di Cielo

- |                                      |                                    |
|--------------------------------------|------------------------------------|
| <input type="radio"/> OL - Oltremare | <input type="radio"/> CO - Corallo |
| <input type="radio"/> SM - Smeraldo  | <input type="radio"/> NI - Ninfea  |
| <input type="radio"/> AL - Alga      | <input type="radio"/> AM - Anemone |

art. **DEC152SXL** / art. **DEC152DXE** /  
art. **DEC152DXL** / art. **DEC152DXE**

art. **DECD152SXE** / art. **DECD152DXE**

### FINITURE MOBILE IN LEGNO CON ANTA FRONTALE IN LISTELLI

WOODEN CABINET FINISHES WITH FRONT DOOR IN SOLID WOODEN STRIPS

essenze legno/wood essences

- |   |
|---|
| <input type="radio"/> RO - Rovere Nero      |
| <input type="radio"/> RG - Rovere Grigio    |
| <input type="radio"/> RS - Rovere Sbiancato |
| <input type="radio"/> RN - Rovere Naturale  |
| <input type="radio"/> EU - Eucalipto        |

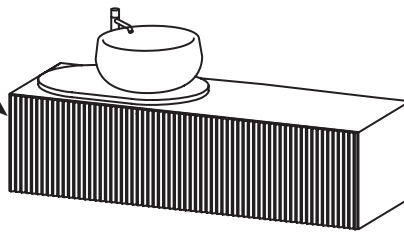

### FINITURE MOBILE IN LEGNO VERSIONE LISCIA

WOODEN CABINET FINISHES - SMOOTH VERSION

laccature/laquerings

essenze legno/wood essences

- |                                     |   |
|-------------------------------------|---|
| <input type="radio"/> TL - Talco    | <input type="radio"/> RO - Rovere Nero      |
| <input type="radio"/> PM - Pomice   | <input type="radio"/> RG - Rovere Grigio    |
| <input type="radio"/> BR - Brina    | <input type="radio"/> RS - Rovere Sbiancato |
| <input type="radio"/> AN - Arenaria | <input type="radio"/> RN - Rovere Naturale  |
| <input type="radio"/> AV - Avena    | <input type="radio"/> EU - Eucalipto        |
| <input type="radio"/> CM - Cemento  |   |
| <input type="radio"/> BA - Basalto  |   |
| <input type="radio"/> MU - Muschio  |   |

**N.B. Indicare obbligatoriamente la posizione**  
It is mandatory to specify the position

**PIANO A DESTRA / LAVABO A DESTRA**  
RIGHT TOP / RIGHT WASHBASIN

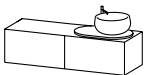

**FORO RUBINETTO SX**  
LEFT TAP HOLE

**NO FORO RUBINETTO\***  
NO TAP HOLE

**PIANO A DESTRA / LAVABO A SINISTRA**  
RIGHT TOP / LEFT WASHBASIN

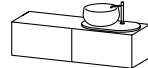

**FORO RUBINETTO DX**  
RIGHT TAP HOLE

**NO FORO RUBINETTO\***  
NO TAP HOLE

**PIANO A SINISTRA / LAVABO A SINISTRA**  
LEFT TOP / LEFT WASHBASIN

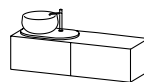

**FORO RUBINETTO DX**  
RIGHT TAP HOLE

**NO FORO RUBINETTO\***  
NO TAP HOLE

**PIANO A SINISTRA / LAVABO A DESTRA**  
LEFT TOP / RIGHT WASHBASIN

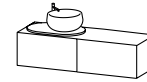

**FORO RUBINETTO SX**  
LEFT TAP HOLE

**NO FORO RUBINETTO\***  
NO TAP HOLE

\*NO FORO RUBINETTO (foro lavabo dx\sx, top ovale reversibile)  
NO TAP HOLE (washbasin hole right/left, oval top ceramic reversible)

**DATA**

DATE \_\_\_\_\_

**FIRMA DEL CLIENTE**

SIGNATURE \_\_\_\_\_

ATTENZIONE:

La rappresentazione delle finiture è puramente indicativa. Verificare le finiture con le relative cartelle. Ogni oggetto possiede la peculiarità di essere elaborato secondo principi puramente tradizionali, in modo da garantirne l'assoluta originalità ed unicità. Le eventuali piccole variazioni di colore, tono o venature fra gli articoli sono da considerarsi pregi e non difetti, in quanto garanzia della fattura manuale del prodotto, che fa di ogni oggetto Cielo un pezzo unico ed esclusivo, lontano dall'omologazione industriale. In fase d'ordine si intendono, pertanto, accettate tali tolleranze che non possono dare adito a contestazioni di alcun genere. Verificare sempre le disponibilità e i tempi di consegna con il commerciale.

ATTENTION:

The representation of the finishes is merely indicative. Please choose the finishes using the folders. Every item possesses that particular feature of being processed according to purely traditional principles that guarantee its absolute originality and uniqueness. The small variations in colour, hues or streaks on the items are to be considered as qualities and not defects, since they warranty the handcrafted processing which makes each Cielo item a unique and exclusive piece that cannot be compared to industrial standardization. When making the order, the client implicitly accepts those various features that may give rise to claims of any sort. Always check the availability and delivery time with the commercial department.

## modelli disponibili / available models

## DELFO

collection

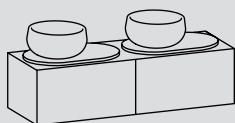

**Delfo 152 mobile con ante frontali lisce**  
Delfo 152 cabinet with smooth front door

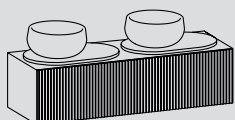

**Delfo 152 mobile con ante frontali in listelli di massello triangolari**  
Delfo 152 cabinet with front door in solid triangular strips



## finiture / finishes

## LAVABO E TOP OVALE IN CERAMICA / CERAMIC WASHBASIN AND REVERSIBLE TOP



BATO



DEPIO76

## Le Terre di Cielo



## Le Acque di Cielo



## MOBILE IN LEGNO VERSIONE LISCIA / WOODEN CABINET SMOOTH VERSION

## laccature / lacquers

## Le Terre di Cielo

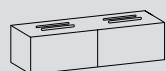
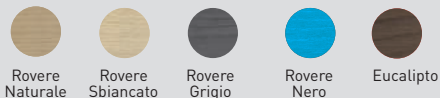

## essenze / wooden finishes

DEC152L  
DEC152EDEC152LSF  
DEC152ESF

## MOBILE IN LEGNO VERSIONE CON LISTELLI/ WOODEN CABINET WITH LATHS

## essenze / wooden finishes

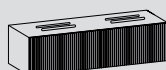
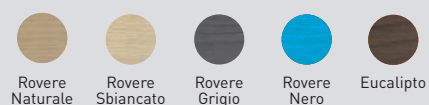

DECD152E

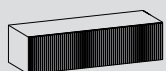

DECD152ESF

## note tecniche lavabo / washbasin technical notes



senza troppopieno  
without overflow



con tutti i lati smaltati  
all enamelled sides



installazione da appoggio  
on top installation



senza foro  
without hole



composizione obbligatoria: lavabo da appoggio Cielo + top  
ovale + mobile con fori  
mandatory combination: on top Cielo washbasin + top + cabinet  
with holes

# Modulo Ordine Delfo 152 con due lavabi

## Delfo 152 with two washbasins Order Form

# cielo

CLIENTE/client:  ORD. REF.:

QUANTITA'/quantity:  EMAIL:

art. **BATO**

### FINITURE LAVABO

WASHBASIN SHELF FINISHES

Bianco/white - glossy

Le Terre di Cielo

- |                                    |                                     |
|------------------------------------|-------------------------------------|
| <input type="radio"/> TL - Talco   | <input type="radio"/> AN - Arenaria |
| <input type="radio"/> PM - Pomice  | <input type="radio"/> AV - Avena    |
| <input type="radio"/> BR - Brina   | <input type="radio"/> LN - Lino     |
| <input type="radio"/> BA - Basalto | <input type="radio"/> AG - Agave    |
| <input type="radio"/> LV - Lavagna | <input type="radio"/> MU - Muschio  |
| <input type="radio"/> CM - Cemento | <input type="radio"/> PL - Polvere  |
| <input type="radio"/> FN - Fango   | <input type="radio"/> CP - Cipria   |
| <input type="radio"/> CA - Cacao   | <input type="radio"/> CN - Canapa   |

Le Acque di Cielo

- |                                      |                                    |
|--------------------------------------|------------------------------------|
| <input type="radio"/> OL - Oltremare | <input type="radio"/> CO - Corallo |
| <input type="radio"/> SM - Smeraldo  | <input type="radio"/> NI - Ninfea  |
| <input type="radio"/> AL - Alga      | <input type="radio"/> AM - Anemone |

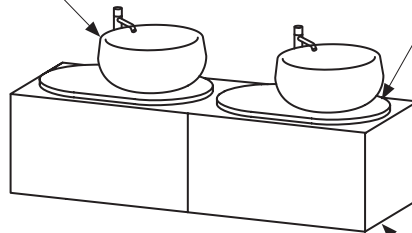

art. **DEPIO76**

### FINITURE TOP OVALE

OVAL TOP FINISHES

Bianco/white - glossy

Le Terre di Cielo

- |                                    |                                     |
|------------------------------------|-------------------------------------|
| <input type="radio"/> TL - Talco   | <input type="radio"/> AN - Arenaria |
| <input type="radio"/> PM - Pomice  | <input type="radio"/> AV - Avena    |
| <input type="radio"/> BR - Brina   | <input type="radio"/> LN - Lino     |
| <input type="radio"/> BA - Basalto | <input type="radio"/> AG - Agave    |
| <input type="radio"/> LV - Lavagna | <input type="radio"/> MU - Muschio  |
| <input type="radio"/> CM - Cemento | <input type="radio"/> PL - Polvere  |
| <input type="radio"/> FN - Fango   | <input type="radio"/> CP - Cipria   |
| <input type="radio"/> CA - Cacao   | <input type="radio"/> CN - Canapa   |

Le Acque di Cielo

- |                                      |                                    |
|--------------------------------------|------------------------------------|
| <input type="radio"/> OL - Oltremare | <input type="radio"/> CO - Corallo |
| <input type="radio"/> SM - Smeraldo  | <input type="radio"/> NI - Ninfea  |
| <input type="radio"/> AL - Alga      | <input type="radio"/> AM - Anemone |

art. **DECD152E**

### FINITURE MOBILE IN LEGNO CON ANTA FRONTALE IN LISTELLI

WOODEN CABINET FINISHES WITH FRONT DOOR IN SOLID WOODEN STRIPS

essenze legno/wood essences

- |   |
|---|
| <input type="radio"/> RO - Rovere Nero      |
| <input type="radio"/> RG - Rovere Grigio    |
| <input type="radio"/> RS - Rovere Sbiancato |
| <input type="radio"/> RN - Rovere Naturale  |
| <input type="radio"/> EU - Eucalipto        |

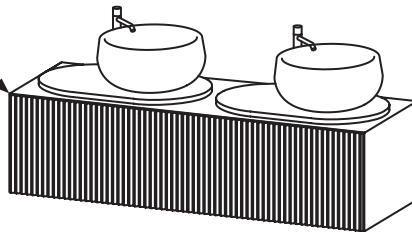

art. **DEC152L / art. DEC152E**

### FINITURE MOBILE IN LEGNO VERSIONE LISCIA

WOODEN CABINET FINISHES - SMOOTH VERSION

laccature/laquerings

- |                                     |   |
|-------------------------------------|---|
| <input type="radio"/> TL - Talco    | <input type="radio"/> RO - Rovere Nero      |
| <input type="radio"/> PM - Pomice   | <input type="radio"/> RG - Rovere Grigio    |
| <input type="radio"/> BR - Brina    | <input type="radio"/> RS - Rovere Sbiancato |
| <input type="radio"/> AN - Arenaria | <input type="radio"/> RN - Rovere Naturale  |
| <input type="radio"/> AV - Avena    | <input type="radio"/> EU - Eucalipto        |
| <input type="radio"/> CM - Cemento  |   |
| <input type="radio"/> BA - Basalto  |   |
| <input type="radio"/> MU - Muschio  |   |

**N.B. Indicare obbligatoriamente la posizione**  
It is mandatory to specify the position

**LAVABI A SINISTRA**  
LEFT WASHBASINS

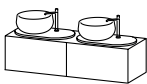

**FORI RUBINETTO DX**  
RIGHT TAP HOLES

**NO FORI RUBINETTO\***  
NO TAP HOLES

**LAVABI A DESTRA**  
RIGHT WASHBASINS

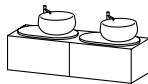

**FORI RUBINETTO SX**  
LEFT TAP HOLES

**NO FORI RUBINETTO\***  
NO TAP HOLES

**LAVABI A SINISTRA / DESTRA**  
LEFT / RIGHT WASHBASINS

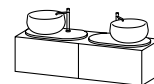

**FORI RUBINETTO DX/SX**  
RIGHT / LEFT TAP HOLES

**NO FORI RUBINETTO\***  
NO TAP HOLES

\*NO FORI RUBINETTO (foro lavabo dx\sx, top ovale reversibile)  
NO TAP HOLES (washbasin hole right\left, oval top ceramic reversible)

**DATA**

DATE

**FIRMA DEL CLIENTE**

SIGNATURE

ATTENZIONE:

La rappresentazione delle finiture è puramente indicativa. Verificare le finiture con le relative cartelle. Ogni oggetto possiede la peculiarità di essere elaborato secondo principi puramente tradizionali, in modo da garantirne l'assoluta originalità ed unicità. Le eventuali piccole variazioni di colore, tono o venature fra gli articoli sono da considerarsi pregi e non difetti, in quanto garanzia della fattura manuale del prodotto, che fa di ogni oggetto Cielo un pezzo unico ed esclusivo, lontano dall'omologazione industriale. In fase d'ordine si intendono, pertanto, accettate tali tolleranze che non possono dare adito a contestazioni di alcun genere. Verificare sempre le disponibilità e i tempi di consegna con il commerciale.

ATTENTION:

The representation of the finishes is merely indicative. Please choose the finishes using the folders. Every item possesses that particular feature of being processed according to purely traditional principles that guarantee its absolute originality and uniqueness. The small variations in colour, hues or streaks on the items are to be considered as qualities and not defects, since they warranty the handcrafted processing which makes each Cielo item a unique and exclusive piece that cannot be compared to industrial standardization. When making the order, the client implicitly accepts those various features that may give rise to claims of any sort. Always check the availability and delivery time with the commercial department.



modelli disponibili / available models

**DELFO**  
collection

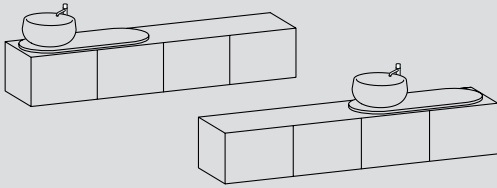

**Delfo 226 mobile con ante frontali lisce**  
Delfo 226 cabinet with smooth front door

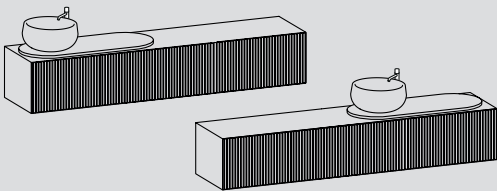

**Delfo 226 mobile con ante frontali in listelli di massello triangolari**  
Delfo 226 cabinet with front door in solid triangular strips



finiture / finishes

**LAVABO E TOP OVALE IN CERAMICA / CERAMIC WASHBASIN AND REVERSIBLE TOP**



BATO



DEPIO

**Le Terre di Cielo**

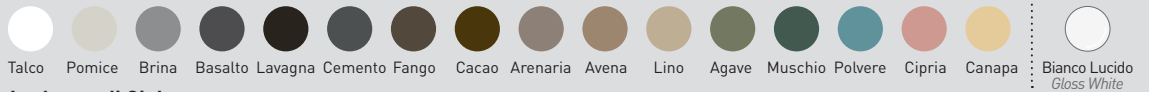

**Le Acque di Cielo**

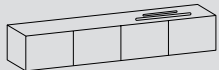

DEC226DXL / DEC226DXE

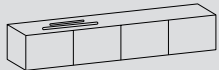

DEC226SXL / DEC226SXE



DEC226LSF / DEC226ESF

**MOBILE IN LEGNO VERSIONE LISCIA / WOODEN CABINET SMOOTH VERSION**

laccature / lacquers

**Le Terre di Cielo**



**essenze / wooden finishes**

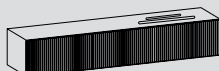
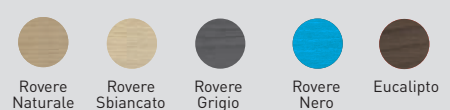

DECD226DXE

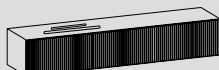

DECD226SXE

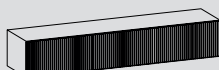

DEC226ESF

**MOBILE IN LEGNO VERSIONE CON LISTELLI / WOODEN CABINET WITH LATHS**

essenze / wooden finishes

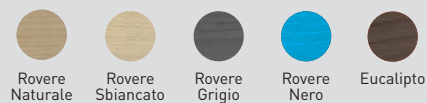

note tecniche lavabo / washbasin technical notes



senza troppopieno  
without overflow



con tutti i lati smaltati  
all enamelled sides



installazione da appoggio  
on top installation



senza foro  
without hole



composizione obbligatoria: lavabo da appoggio Cielo + top  
ovale + mobile con fori  
mandatory combination: on top Cielo washbasin + top + cabinet  
with holes

# Modulo Ordine Delfo 226 con un lavabo

## Delfo 226 with one washbasin with Order Form

# cielo

CLIENTE/client:  ORD. REF.:

QUANTITA'/quantity:  EMAIL:

art. **BATO**

art. **DEPIO**

### FINITURE LAVABO

WASHBASIN SHELF FINISHES

Bianco/white - glossy

Le Terre di Cielo

- |                                    |                                     |
|------------------------------------|-------------------------------------|
| <input type="radio"/> TL - Talco   | <input type="radio"/> AN - Arenaria |
| <input type="radio"/> PM - Pomice  | <input type="radio"/> AV - Avena    |
| <input type="radio"/> BR - Brina   | <input type="radio"/> LN - Lino     |
| <input type="radio"/> BA - Basalto | <input type="radio"/> AG - Agave    |
| <input type="radio"/> LV - Lavagna | <input type="radio"/> MU - Muschio  |
| <input type="radio"/> CM - Cemento | <input type="radio"/> PL - Polvere  |
| <input type="radio"/> FN - Fango   | <input type="radio"/> CP - Cipria   |
| <input type="radio"/> CA - Cacao   | <input type="radio"/> CN - Canapa   |

Le Acque di Cielo

- |                                      |                                    |
|--------------------------------------|------------------------------------|
| <input type="radio"/> OL - Oltremare | <input type="radio"/> CO - Corallo |
| <input type="radio"/> SM - Smeraldo  | <input type="radio"/> NI - Ninfea  |
| <input type="radio"/> AL - Alga      | <input type="radio"/> AM - Anemone |

### FINITURE TOP OVALE

OVAL TOP FINISHES

Bianco/white - glossy

Le Terre di Cielo

- |                                    |                                     |
|------------------------------------|-------------------------------------|
| <input type="radio"/> TL - Talco   | <input type="radio"/> AN - Arenaria |
| <input type="radio"/> PM - Pomice  | <input type="radio"/> AV - Avena    |
| <input type="radio"/> BR - Brina   | <input type="radio"/> LN - Lino     |
| <input type="radio"/> BA - Basalto | <input type="radio"/> AG - Agave    |
| <input type="radio"/> LV - Lavagna | <input type="radio"/> MU - Muschio  |
| <input type="radio"/> CM - Cemento | <input type="radio"/> PL - Polvere  |
| <input type="radio"/> FN - Fango   | <input type="radio"/> CP - Cipria   |
| <input type="radio"/> CA - Cacao   | <input type="radio"/> CN - Canapa   |

Le Acque di Cielo

- |                                      |                                    |
|--------------------------------------|------------------------------------|
| <input type="radio"/> OL - Oltremare | <input type="radio"/> CO - Corallo |
| <input type="radio"/> SM - Smeraldo  | <input type="radio"/> NI - Ninfea  |
| <input type="radio"/> AL - Alga      | <input type="radio"/> AM - Anemone |

art. **DECD226SX** / art. **DECD226DX**

art. **DEC226SXL** / art. **DEC226SXE** /  
art. **DEC226DXL** / art. **DEC226DXE**

### FINITURE MOBILE IN LEGNO CON ANTA FRONTALE IN LISTELLI

WOODEN CABINET FINISHES WITH FRONT DOOR IN SOLID WOODEN STRIPS

essenze legno/wood essences

- |   |
|---|
| <input type="radio"/> RO - Rovere Nero      |
| <input type="radio"/> RG - Rovere Grigio    |
| <input type="radio"/> RS - Rovere Sbiancato |
| <input type="radio"/> RN - Rovere Naturale  |
| <input type="radio"/> EU - Eucalipto        |

### FINITURE MOBILE IN LEGNO

WOODEN CABINET FINISHES - SMOOTH VERSION

laccature/laquerings  
essenze legno/  
wood essences

- |                                     |   |
|-------------------------------------|---|
| <input type="radio"/> TL - Talco    | <input type="radio"/> RO - Rovere Nero      |
| <input type="radio"/> PM - Pomice   | <input type="radio"/> RG - Rovere Grigio    |
| <input type="radio"/> BR - Brina    | <input type="radio"/> RS - Rovere Sbiancato |
| <input type="radio"/> AN - Arenaria | <input type="radio"/> RN - Rovere Naturale  |
| <input type="radio"/> AV - Avena    | <input type="radio"/> EU - Eucalipto        |
| <input type="radio"/> CM - Cemento  |   |
| <input type="radio"/> BA - Basalto  |   |
| <input type="radio"/> MU - Muschio  |   |

**N.B. Indicare obbligatoriamente la posizione**  
It is mandatory to specify the position

**PIANO A DESTRA / LAVABO A DESTRA**  
RIGHT TOP / RIGHT WASHBASIN

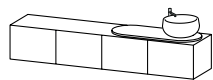

FORO RUBINETTO SX  
LEFT TAP HOLE

NO FORO RUBINETTO\*  
NO TAP HOLE

**PIANO A DESTRA / LAVABO A SINISTRA**  
RIGHT TOP / LEFT WASHBASIN

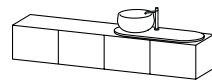

FORO RUBINETTO DX  
RIGHT TAP HOLE

NO FORO RUBINETTO\*  
NO TAP HOLE

**PIANO A SINISTRA / LAVABO A SINISTRA**  
LEFT TOP / LEFT WASHBASIN

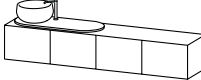

FORO RUBINETTO DX  
RIGHT TAP HOLE

NO FORO RUBINETTO\*  
NO TAP HOLE

**PIANO A SINISTRA / LAVABO A DESTRA**  
LEFT TOP / RIGHT WASHBASIN

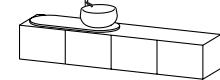

FORO RUBINETTO SX  
LEFT TAP HOLE

NO FORO RUBINETTO\*  
NO TAP HOLE

\*NO FORO RUBINETTO (foro lavabo dx\lx, top ovale reversibile)  
NO TAP HOLE (washbasin hole right/left, oval top ceramic reversible)

**DATA**

DATE

ATTENZIONE:

La rappresentazione delle finiture è puramente indicativa. Verificare le finiture con le relative cartelle. Ogni oggetto possiede la peculiarità di essere elaborato secondo principi puramente tradizionali, in modo da garantirne l'assoluta originalità ed unicità. Le eventuali piccole variazioni di colore, tono o venature fra gli articoli sono da considerarsi pregi e non difetti, in quanto garanzia della fattura manuale del prodotto, che fa di ogni oggetto Cielo un pezzo unico ed esclusivo, lontano dall'omologazione industriale. In fase d'ordine si intendono, pertanto, accettate tali tolleranze che non possono dare adito a contestazioni di alcun genere. Verificare sempre le disponibilità e i tempi di consegna con il commerciale.

ATTENTION:

The representation of the finishes is merely indicative. Please choose the finishes using the folders. Every item possesses that particular feature of being processed according to purely traditional principles that guarantee its absolute originality and uniqueness. The small variations in colour, hues or streaks on the items are to be considered as qualities and not defects, since they warranty the handcrafted processing which makes each Cielo item a unique and exclusive piece that cannot be compared to industrial standardization. When making the order, the client implicitly accepts those various features that may give rise to claims of any sort. Always check the availability and delivery time with the commercial department.

**FIRMA DEL CLIENTE**

SIGNATURE



**modelli disponibili / available models**

**DELFO**  
collection

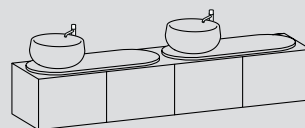

**Delfo 226 mobile con ante frontali lisce**  
Delfo 226 cabinet with smooth front door

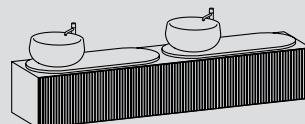

**Delfo 226 mobile con ante frontali in listelli di massello triangolari**  
Delfo 226 cabinet with front door in solid triangular strips

**finiture / finishes**

**LAVABO E TOP OVALE IN CERAMICA / CERAMIC WASHBASIN AND REVERSIBLE TOP**

**Le Terre di Cielo**

Bianco Lucido  
Glass White

Talco Pomice Brina Basalto Lavagna Cemento Fango Cacao Arenaria Avena Lino Agave Muschio Polvere Cipria Canapa

**Le Acque di Cielo**

Oltremare Smeraldo Alga Corallo Ninfea Anemone

BATO

DEPIO

**MOBILE IN LEGNO VERSIONE LISCIA / WOODEN CABINET SMOOTH VERSION**

**Le Terre di Cielo**

Talco Pomice Brina Cemento Basalto Muschio Arenaria Avena

**essenze / wooden finishes**

Rovere Naturale Rovere Sbiancato Rovere Grigio Rovere Nero Eucalipto

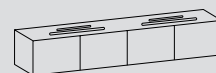

DEC226L  
DEC226E



DEC226LSF  
DEC226ESF

**MOBILE IN LEGNO VERSIONE CON LISTELLI/ WOODEN CABINET WITH LATHS**

**essenze / wooden finishes**

Rovere Naturale Rovere Sbiancato Rovere Grigio Rovere Nero Eucalipto

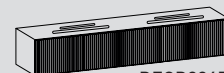

DECD226E

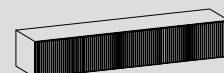

DECD226ESF

**note tecniche lavabo / washbasin technical notes**

**senza troppopieno**  
without overflow
  **con tutti i lati smaltati**  
all enamelled sides
  **installazione da appoggio**  
on top installation
  **senza foro**  
without hole
  **composizione obbligatoria: lavabo da appoggio Cielo + top ovale + mobile con fori**  
mandatory combination: on top Cielo washbasin + top + cabinet with holes

# Modulo Ordine Delfo 226 con due lavabi

## Delfo 226 with two washbasins Order Form

CLIENTE/client:  ORD. REF.:

QUANTITA'/quantity:  EMAIL:

art. **BATO**

### FINITURE LAVABO

WASHBASIN SHELF FINISHES

Bianco/white - glossy

Le Terre di Cielo

- |                                    |                                     |
|------------------------------------|-------------------------------------|
| <input type="radio"/> TL - Talco   | <input type="radio"/> AN - Arenaria |
| <input type="radio"/> PM - Pomice  | <input type="radio"/> AV - Avena    |
| <input type="radio"/> BR - Brina   | <input type="radio"/> LN - Lino     |
| <input type="radio"/> BA - Basalto | <input type="radio"/> AG - Agave    |
| <input type="radio"/> LV - Lavagna | <input type="radio"/> MU - Muschio  |
| <input type="radio"/> CM - Cemento | <input type="radio"/> PL - Polvere  |
| <input type="radio"/> FN - Fango   | <input type="radio"/> CP - Cipria   |
| <input type="radio"/> CA - Cacao   | <input type="radio"/> CN - Canapa   |

Le Acque di Cielo

- |                                      |                                    |
|--------------------------------------|------------------------------------|
| <input type="radio"/> OL - Oltremare | <input type="radio"/> CO - Corallo |
| <input type="radio"/> SM - Smeraldo  | <input type="radio"/> NI - Ninfea  |
| <input type="radio"/> AL - Alga      | <input type="radio"/> AM - Anemone |

art. **DEPIO**

### FINITURE TOP OVALE

OVAL TOP FINISHES

Bianco/white - glossy

Le Terre di Cielo

- |                                    |                                     |
|------------------------------------|-------------------------------------|
| <input type="radio"/> TL - Talco   | <input type="radio"/> AN - Arenaria |
| <input type="radio"/> PM - Pomice  | <input type="radio"/> AV - Avena    |
| <input type="radio"/> BR - Brina   | <input type="radio"/> LN - Lino     |
| <input type="radio"/> BA - Basalto | <input type="radio"/> AG - Agave    |
| <input type="radio"/> LV - Lavagna | <input type="radio"/> MU - Muschio  |
| <input type="radio"/> CM - Cemento | <input type="radio"/> PL - Polvere  |
| <input type="radio"/> FN - Fango   | <input type="radio"/> CP - Cipria   |
| <input type="radio"/> CA - Cacao   | <input type="radio"/> CN - Canapa   |

Le Acque di Cielo

- |                                      |                                    |
|--------------------------------------|------------------------------------|
| <input type="radio"/> OL - Oltremare | <input type="radio"/> CO - Corallo |
| <input type="radio"/> SM - Smeraldo  | <input type="radio"/> NI - Ninfea  |
| <input type="radio"/> AL - Alga      | <input type="radio"/> AM - Anemone |

art. **DECD226E**

### FINITURE MOBILE IN LEGNO CON ANTA FRONTALE IN LISTELLI

WOODEN CABINET FINISHES WITH FRONT DOOR IN SOLID WOODEN STRIPS

essenze legno/wood essences

- |   |
|---|
| <input type="radio"/> RO - Rovere Nero      |
| <input type="radio"/> RG - Rovere Grigio    |
| <input type="radio"/> RS - Rovere Sbiancato |
| <input type="radio"/> RN - Rovere Naturale  |
| <input type="radio"/> EU - Eucalipto        |

art. **DEC226L** / art. **DEC226E**

### FINITURE MOBILE IN LEGNO

VERSIONE LISCIA  
WOODEN CABINET FINISHES - SMOOTH VERSION

laccature/laquerings      essenze legno/  
wood essences

- |                                     |   |
|-------------------------------------|---|
| <input type="radio"/> TL - Talco    | <input type="radio"/> RO - Rovere Nero      |
| <input type="radio"/> PM - Pomice   | <input type="radio"/> RG - Rovere Grigio    |
| <input type="radio"/> BR - Brina    | <input type="radio"/> RS - Rovere Sbiancato |
| <input type="radio"/> AN - Arenaria | <input type="radio"/> RN - Rovere Naturale  |
| <input type="radio"/> AV - Avena    | <input type="radio"/> EU - Eucalipto        |
| <input type="radio"/> CM - Cemento  |   |
| <input type="radio"/> BA - Basalto  |   |
| <input type="radio"/> MU - Muschio  |   |

**N.B. Indicare obbligatoriamente la posizione**  
It is mandatory to specify the position

**LAVABI A SINISTRA**  
LEFT WASHBASINS

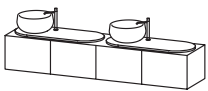

**FORI RUBINETTO DX**  
RIGHT TAP HOLES

**NO FORI RUBINETTO\***  
NO TAP HOLES

**LAVABI A DESTRA**  
RIGHT WASHBASINS

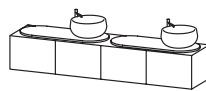

**FORI RUBINETTO SX**  
LEFT TAP HOLES

**NO FORI RUBINETTO\***  
NO TAP HOLES

**LAVABI A SINISTRA / DESTRA**  
LEFT / RIGHT WASHBASINS

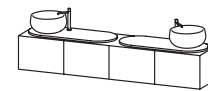

**FORI RUBINETTO DX/SX**  
RIGHT / LEFT TAP HOLES

**NO FORI RUBINETTO\***  
NO TAP HOLES

\*NO FORI RUBINETTO (foro lavabo dx\sx, top ovale reversibile)  
NO TAP HOLES (washbasin hole right\left, oval top ceramic reversible)

**DATA**

DATE

**FIRMA DEL CLIENTE**











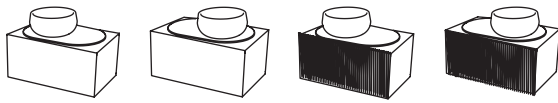







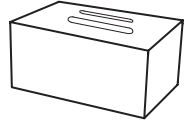

SIGNATURE

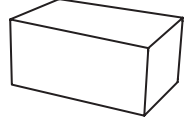
ATTENZIONE:

La rappresentazione delle finiture è puramente indicativa. Verificare le finiture con le relative cartelle. Ogni oggetto possiede la peculiarità di essere elaborato secondo principi puramente tradizionali, in modo da garantirne l'assoluta originalità ed unicità. Le eventuali piccole variazioni di colore, tono o venature fra gli articoli sono da considerarsi pregi e non difetti, in quanto garanzia della fattura manuale del prodotto, che fa di ogni oggetto Cielo un pezzo unico ed esclusivo, lontano dall'omologazione industriale. In fase d'ordine si intendono, pertanto, accettate tali tolleranze che non possono dare adito a contestazioni di alcun genere. Verificare sempre le disponibilità e i tempi di consegna con il commerciale.

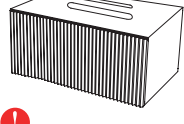
ATTENTION:

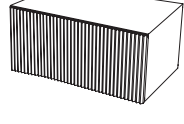
The representation of the finishes is merely indicative. Please choose the finishes using the folders. Every item possesses that particular feature of being processed according to purely traditional principles that guarantee its absolute originality and uniqueness. The small variations in colour, hues or streaks on the items are to be considered as qualities and not defects, since they warranty the handcrafted processing which makes each Cielo item a unique and exclusive piece that cannot be compared to industrial standardization. When making the order, the client implicitly accepts those various features that may give rise to claims of any sort. Always check the availability and delivery time with the commercial department.

	<b>Size (cm)</b> Medidas Dimensions Maße Размеры	<b>Product code</b> Artículo Article Artikel Артикул	<b>Net weight (Kg)</b> Peso neto Poids net Reingewicht вес нетто	<b>Finishes</b> Acabados Finitions Farbe Отделки	<b>Euro</b> Евро
 <p><b>On top bowl h19 Tino</b>                      Cubela de apoyo h19 Tino                      Vasque à poser h19 Tino                      Aufsatzbecken h19 Tino                      Накладная чаша h19 Tino</p>	43 x 43 x 19 h	BATO(X)*	10,30	<ul style="list-style-type: none"> <li> <b>Gloss White</b></li> <li> <b>Le Terre di Cielo</b></li> <li> <b>Le Acque di Cielo</b></li> </ul>	<ul style="list-style-type: none"> <li><b>427,00</b></li> <li><b>697,00</b></li> <li><b>697,00</b></li> </ul>
 <p><b>Ceramic oval countertop, reversible</b> \ Top ovalado en cerámica reversible \ Plan ovale en céramique réversible \ Ovale Platte aus Keramik reversibel \ Овальная керамическая столешница</p> <p><b>!</b></p> <p><b>N.B. Tap/Faucet hole on request (mandatory position – see technical data sheet and order form).</b> \ Orificio grifo a petición (posición obligada-veáse ficha técnica y módulo de pedido) \ N.B. : Trou de robinet sur demande (position obligée – voir fiche technique et bon de commande) \ Hinweis: Hahnloch auf Anfrage (Position obligatorisch – siehe technisches Datenblatt und Bestellformular) \ P.S. Отверстие под смеситель по запросу (возможное место расположения отверстия – проверьте на технической карте изделия и модуле заказа)</p>	72 x 45,5 x 2h	DEPIO76(X)*	10,00	<ul style="list-style-type: none"> <li> <b>Gloss White</b></li> <li> <b>Le Terre di Cielo</b></li> <li> <b>Le Acque di Cielo</b></li> </ul>	<ul style="list-style-type: none"> <li><b>388,00</b></li> <li><b>460,00</b></li> <li><b>460,00</b></li> </ul>
 <p><b>Lacquered cabinet</b>                      Mueble lacado \ Meuble laqué \ Möbel lackiert \ Тумба крашенная</p>	76 x 48 x 40h	DEC76L(X)*	34,50	<ul style="list-style-type: none"> <li> <b>Le Terre di Cielo *</b></li> </ul>	<b>1574,00</b>
 <p><b>Cabinet in wooden finish</b>                      Mueble en madera \ Meuble bois \ Möbel aus Holz \ Тумба в деревянной отделке</p> <p><b>!</b></p>	76 x 48 x 40h	DEC76E(X)*	34,50	<ul style="list-style-type: none"> <li> <b>EsSENze Rovere •</b></li> <li> <b>*X = EU - Eucalipto</b></li> </ul>	<ul style="list-style-type: none"> <li><b>2056,00</b></li> <li><b>2412,00</b></li> </ul>
 <p><b>Lacquered cabinet without holes</b>                      Mueble lacado sin agujero \ Meuble laqué sans orifice \ Möbel lackiert ohne Hahnloch \ Тумба крашенная без отверстия</p>	76 x 48 x 40h	DEC76LSF(X)*	35,00	<ul style="list-style-type: none"> <li> <b>Le Terre di Cielo *</b></li> </ul>	<b>1574,00</b>
 <p><b>Cabinet in wooden finish without holes</b>                      Mueble en madera sin agujero \ Meuble bois sans orifice \ Möbel aus Holz ohne Hahnloch \ Тумба в деревянной отделке без отверстия</p>	76 x 48 x 40h	DEC76ESF(X)*	35,00	<ul style="list-style-type: none"> <li> <b>EsSENze Rovere •</b></li> <li> <b>*X = EU - Eucalipto</b></li> </ul>	<ul style="list-style-type: none"> <li><b>2056,00</b></li> <li><b>2412,00</b></li> </ul>
 <p><b>Cabinet with front drawer in solid triangular wooden strips</b>                      Mueble con frontal de cajón en listones triangulares de madera maciza en madera sin agujero \ Armoire avec façade de tiroir en bandes de bois massif triangulaires en essence \ Möbel mit Frontschublade aus dreieckigen Massivholzleisten \ Тумба с вертикальными планками из цельного дерева на фасаде</p> <p><b>!</b></p>	75,5 x 50 x 40h	DECD76E(X)*	33,00	<ul style="list-style-type: none"> <li> <b>EsSENze Rovere •</b></li> <li> <b>*X = EU - Eucalipto</b></li> </ul>	<ul style="list-style-type: none"> <li><b>4572,00</b></li> <li><b>5077,00</b></li> </ul>
 <p><b>Cabinet with front drawer in solid triangular wooden strips without holes</b>                      Mueble con frontal de cajón en listones triangulares de madera maciza en madera sin agujero \ Armoire avec façade de tiroir en bandes de bois massif triangulaires en essence sans orifice \ Möbel mit Frontschublade aus dreieckigen Massivholzleisten ohne Hahnloch \ Тумба с вертикальными планками из цельного дерева на фасаде без отверстия</p>	75,5 x 50 x 40h	DEC76ESF(X)*	33,00	<ul style="list-style-type: none"> <li> <b>EsSENze Rovere •</b></li> <li> <b>*X = EU - Eucalipto</b></li> </ul>	<ul style="list-style-type: none"> <li><b>4572,00</b></li> <li><b>5077,00</b></li> </ul>

**!** **mandatory combination: on top Cielo washbasin + top + cabinet with holes**  
 combinaison obligatoire: cubela de apoyo Cielo + encimera + mueble los agujeros \ combinación obligatoria: vasque à poser Cielo + plan + meuble con orifice \ obligatorische Kombination: Aufsatzbecken Cielo + Holzregal + Möbel mit Hahnloch \ обязательное сочетание: Накладная Cielo + столешница + Тумба con отверстия

























**Technical symbols legend**  
 Símbolos técnicos clave / Légende symboles techniques / Technische Zeichenerklärung / Перечень технических символов

 **all sides are enamelled**  
 con todos los lados esmaltados avec tous les côtés émaillés alle Seiten glasiert все стороны покрыты эмалью

 **no tap holes**  
 sin agujero para grifo sans orifice robinet ohne Hahnloch без отверстия под смеситель

 **without overflow**  
 sin rebosadero sans trop-plein ohne Überlauf без слива-перелива

 **on top installation**  
 instalación de apoyo installation à partir du plan Montage auf Platte установка на столешницу

	Product code Artículo Article Artikel Артикул	Net weight (Kg) Peso neto Poids net Reingewicht вес нетто	Finishes Acabados Finitions Farbe Отделки	Euro Евро
 <p><b>Universal click/clack drain in CHROME with ceramic lid</b> Válvula universal click/clack Cromado con tapa en cerámica \ Bonde universelle clic/clac Chromé avec clapet en céramique \ Universal-Ablaufgarnitur Click-Clack Chrom mit Keramikstopfen \ Универсальный донный клапан click/clack хром с керамической крышкой</p>	PIL01(X)*	0,40	 <b>Gloss White</b>  <b>Le Terre di Cielo</b>  <b>Le Acque di Cielo</b>	<b>95,00</b> <b>139,00</b> <b>139,00</b>
 <p><b>Universal click/clack drain in BLACK MATT finish with ceramic lid</b> Válvula universal click/clack Negro Matt con tapa en cerámica \ Bonde universelle clic/clac Noir Matt avec clapet en céramique \ Universal-Ablaufgarnitur Click-Clack Matt Schwarz mit Keramikstopfen \ Универсальный донный клапан click/clack черный матовый с керамической крышкой</p>	PIL01NM(X)*	0,40	 <b>Gloss White</b>  <b>Le Terre di Cielo</b>  <b>Le Acque di Cielo</b>	<b>120,00</b> <b>169,00</b> <b>169,00</b>
 <p><b>Universal click/clack drain in CEMENTO finish with ceramic lid</b> Válvula universal click/clack Cemento con tapa en cerámica \ Bonde universelle clic/clac Cemento avec clapet en céramique \ Universal-Ablaufgarnitur Click-Clack Cement mit Keramikstopfen \ Универсальный донный Cemento click/clack с керамической крышкой</p>	PIL01CM(X)*	0,40	 <b>Gloss White</b>  <b>Le Terre di Cielo</b>  <b>Le Acque di Cielo</b>	<b>120,00</b> <b>169,00</b> <b>169,00</b>
 <p><b>Universal click/clack drain in BRONZE with ceramic lid</b> Válvula universal click/clack Bronce con tapa en cerámica \ Bonde universelle clic/clac Bronce avec clapet en céramique \ Universal-Ablaufgarnitur Click-Clack Bronze mit Keramikstopfen \ Универсальный донный клапан click/clack бронза с керамической крышкой</p>	PIL01BR(X)*	0,40	 <b>Gloss White</b>  <b>Le Terre di Cielo</b>  <b>Le Acque di Cielo</b>	<b>135,00</b> <b>182,00</b> <b>182,00</b>
 <p><b>CHROMED siphon</b> Sifone Cromado \ Siphon Chromé \ Siphon Verchromt \ сифон Chrome</p>	SISP	0,93	 <b>Chrome</b>	<b>133,00</b>
 <p><b>MATT BLACK siphon</b> Sifone Negro Mate \ Siphon Noir Mat \ Siphon Schwarz Matt \ Сифон Черный матовый</p>	SIFN	0,93	 <b>Matt Black</b>	<b>194,00</b>
 <p><b>CEMENTO siphon</b> Sifone Cemento \ Siphon Cemento \ Siphon Cemento \ сифон Cemento</p>	SIFCM	0,93	 <b>Cemento</b>	<b>194,00</b>
 <p><b>BRONZE siphon</b> Sifone Bronce \ Siphon Bronce \ Siphon Bronce \ бронза сифон</p>	SIFBR	0,93	 <b>Bronze</b>	<b>220,00</b>

Terre di Cielo available for washbasins and ceramic shelf | Terre di Cielo disponibles para el lavabo y la encimera de cerámica | Terre di Cielo disponibles pour le lavabo et le plan en céramique | Für Waschbecken und Keramikplatte erhältliche Terre di Cielo | Отделка Terre di Cielo доступны для раковины и керамических столешниц

-  TL - Talco
-  PM - Pomice
-  BR - Brina
-  BA - Basalto
-  LV - Lavagna
-  CM - Cemento
-  FN - Fango
-  CA - Cacao
-  AN - Arenaria
-  AV - Avena
-  LN - Lino
-  AG - Agave
-  MU - Muschio
-  PL - Polvere
-  CP - Cipria
-  CN - Canapa

Acque di Cielo available for washbasins and ceramic shelf | Acque di Cielo disponibles para el lavabo y la encimera de cerámica | Acque di Cielo disponibles pour le lavabo et le plan en céramique | Für Waschbecken und Keramikplatte erhältliche Acque di Cielo | Отделка Acque di Cielo доступны для раковины и керамических столешниц

-  OL - Oltremare
-  SM - Smeraldo
-  AL - Alga
-  CO - Corallo
-  NI - Ninfea
-  AM - Anemone



\* Terre di Cielo laquering available for cabinet | lacados Terre di Cielo disponibles para mueble | laquages Terre di Cielo disponibles pour le meuble | Für Möbel erhältliche Lackierungen Terre di Cielo | крашенная отделка Terre di Cielo доступна для ящика и столешницы

-  TL - Talco
-  PM - Pomice
-  BR - Brina
-  BA - Basalto
-  AN - Arenaria
-  MU - Muschio
-  AV - Avena
-  CM - Cemento

• Oak finishes available for the cabinet - a smooth version and a version with the front door in solid triangular wooden strips | Essence Rovere disponible para el mueble en versión lisa o versión con puerta frontal con tiras de madera maciza triangulares | Essences Chêne disponibles pour le meuble en version lisse et en version avec porte frontale ornée de listels triangulaires en essence de bois massif | Holzarten Eiche für das Möbel in glatter Ausführung und in der Ausführung mit Fronttür aus dreieckigen Massivholzleisten erhältlich | Натуральные шпоны дуба доступны для тумбы с гладкой поверхностью и тумбы с передней дверцей из массива бруса треугольной формы из натурального шпона дерева

-  RS - Rovere Sbiancato
-  RN - Rovere Naturale
-  RG - Rovere Grigio
-  RO - Rovere Nero

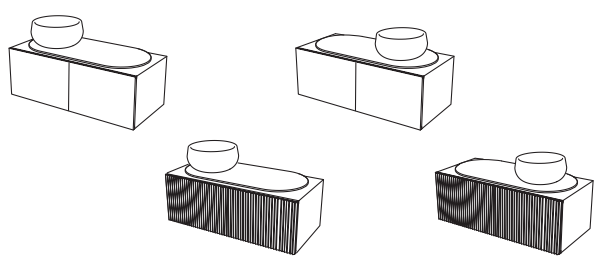

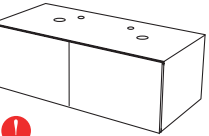
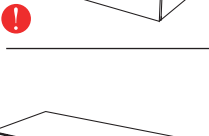
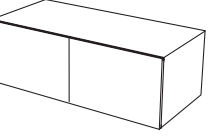
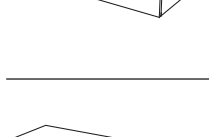
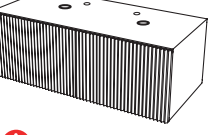
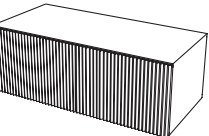
	<b>Size (cm)</b> Medidas Dimensions Maße Размеры	<b>Product code</b> Artículo Article Artikel Артикул	<b>Net weight (Kg)</b> Peso neto Poids net Reingewicht вес нетто	<b>Finishes</b> Acabados Finitions Farbe Отделки	<b>Euro</b> Евро
	113 x 52				
 <p><b>On top bowl h19 Tino</b>                      Cubela de apoyo h19 Tino                      Vasque à poser h19 Tino                      Aufsatzbecken h19 Tino                      Накладная чаша h19 Tino</p>	43 x 43 x 19 h	BATO(X)*	10,30	Gloss White Le Terre di Cielo Le Acque di Cielo	427,00 697,00 697,00
 <p><b>Ceramic oval countertop, reversible</b> \ Top ovalado en cerámica reversible \ Plan ovale en céramique reversible \ Ovale Platte aus Keramik reversibel \ Овальная керамическая столешница</p> <p><b>N.B. Tap/Faucet hole on request (mandatory position – see technical data sheet and order form).</b> \ Orificio grifo a petición (posición obligada-vease ficha técnica y módulo de pedido) \ N.B. : Trou de robinet sur demande (position obligée – voir fiche technique et bon de commande) \ Hinweis: Hahnloch auf Anfrage (Position obligatorisch – siehe technisches Datenblatt und Bestellformular) \ P.S. Отверстие под смеситель по запросу (возможное место расположения отверстия – проверьте на технической карте изделия и модуле заказа)</p>	107 x 47 x 2h	DEPIO(X)*	17,00	Gloss White Le Terre di Cielo Le Acque di Cielo	447,00 486,00 486,00 25,00
 <p><b>Lacquered cabinet</b>                      Mueble lacado \ Meuble laqué \ Möbel lackiert \ Тумба крашенная</p>	113 x 52 x 40h	DECL(X)*	45,70	Le Terre di Cielo *	2026,00
 <p><b>Cabinet in wooden finish</b>                      Mueble en madera \ Meuble bois \ Möbel aus Holz \ Тумба в деревянной отделке</p>	113 x 52 x 40h	DECE(X)*	45,70	Essenze Rovere • *X = EU - Eucalipto	2535,00 2994,00
 <p><b>Lacquered cabinet without holes</b>                      Mueble lacado sin agujero \ Meuble laqué sans orifice \ Möbel lackiert ohne Hahnloch \ Тумба крашенная без отверстия</p>	113 x 52 x 40h	DECLSF(X)*	46,00	Le Terre di Cielo *	2026,00
 <p><b>Cabinet in wooden finish without holes</b>                      Mueble en madera sin agujero \ Meuble bois sans orifice \ Möbel aus Holz ohne Hahnloch \ Тумба в деревянной отделке без отверстия</p>	113 x 52 x 40h	DECESF(X)*	46,00	Essenze Rovere • *X = EU - Eucalipto	2535,00 2994,00
 <p><b>Cabinet with front drawer in solid triangular wooden strips</b>                      Mueble con frontal de cajón en listones triangulares de madera maciza en madera \ Armoire avec façade de tiroir en bandes de bois massif triangulaires en essence \ Möbel mit Frontschublade aus dreieckigen Massivholzleisten \ Тумба с вертикальными планками из цельного дерева на фасаде</p>	113 x 52 x 40h	DECDE(X)*	44,50	Essenze Rovere • *X = EU - Eucalipto	5271,00 5937,00
 <p><b>Cabinet with front drawer in solid triangular wooden strips without holes</b>                      Mueble con frontal de cajón en listones triangulares de madera maciza en madera sin agujero \ Armoire avec façade de tiroir en bandes de bois massif triangulaires en essence sans orifice \ Möbel mit Frontschublade aus dreieckigen Massivholzleisten ohne Hahnloch \ Тумба с вертикальными планками из цельного дерева на фасаде без отверстия</p>	113 x 52 x 40h	DECDESF(X)*	44,80	Essenze Rovere • *X = EU - Eucalipto	5271,00 5937,00

**mandatory combination: on top Cielo washbasin + top + cabinet with holes**  
 combinaison obligatoire: cubela de apoyo Cielo + encimera + mueble los agujeros \ combinación obligatoria: vasque à poser Cielo + plan + meuble con orifice \ obligatorische Kombination: Aufsatzbecken Cielo + Holzregal + Möbel mit Hahnloch \ обязательное сочетание: Накладная Cielo + столешница + Тумба с отверстием

**Technical symbols legend**  
 Símbolos técnicos clave / Légende symboles techniques / Technische Zeichenerklärung / Перечень технических символов

 all sides are enamelled  
 con todos los lados esmaltados / avec tous les côtés émaillés / alle Seiten glasiert / все стороны покрыты эмалью

 no tap holes  
 sin agujero para grifo / sans orifice robinet / ohne Hahnloch / без отверстия под смеситель

























 without overflow  
 sin rebosadero / sans trop-plein / ohne Überlauf / без слива-перелива

 on top installation  
 instalación de apoyo / installation à partir du plan / Montage auf Platte / установка на столешницу

# Delfo 113

drains and siphons / desagües y sifones / les drains et les siphons / Ablaufgarnituren und Siphons / Донные клапаны и сифоны







# cielo

	Product code Artículo Article Artikel Артикул	Net weight (Kg) Peso neto Poids net Reingewicht вес нетто	Finishes Acabados Finitions Farbe Отделки	Euro Евро
 <p><b>Universal click/clack drain in CHROME with ceramic lid</b> Válvula universal click/clack Cromado con tapa en cerámica \ Bonde universelle clic/clac Chromé avec clapet en céramique \ Universal-Ablaufgarnitur Click-Clack Chrom mit Keramikstopfen \ Универсальный донный клапан click/clack хром с керамической крышкой</p>	PIL01(X)*	0,40	 <b>Gloss White</b>  <b>Le Terre di Cielo</b>  <b>Le Acque di Cielo</b>	<b>95,00</b> <b>139,00</b> <b>139,00</b>
 <p><b>Universal click/clack drain in BLACK MATT finish with ceramic lid</b> Válvula universal click/clack Negro Matt con tapa en cerámica \ Bonde universelle clic/clac Noir Matt avec clapet en céramique \ Universal-Ablaufgarnitur Click-Clack Matt Schwarz mit Keramikstopfen \ Универсальный донный клапан click/clack черный матовый с керамической крышкой</p>	PIL01NM(X)*	0,40	 <b>Gloss White</b>  <b>Le Terre di Cielo</b>  <b>Le Acque di Cielo</b>	<b>120,00</b> <b>169,00</b> <b>169,00</b>
 <p><b>Universal click/clack drain in CEMENTO finish with ceramic lid</b> Válvula universal click/clack Cemento con tapa en cerámica \ Bonde universelle clic/clac Cemento avec clapet en céramique \ Universal-Ablaufgarnitur Click-Clack Cement mit Keramikstopfen \ Универсальный донный Cemento click/clack с керамической крышкой</p>	PIL01CM(X)*	0,40	 <b>Gloss White</b>  <b>Le Terre di Cielo</b>  <b>Le Acque di Cielo</b>	<b>120,00</b> <b>169,00</b> <b>169,00</b>
 <p><b>Universal click/clack drain in BRONZE with ceramic lid</b> Válvula universal click/clack Bronce con tapa en cerámica \ Bonde universelle clic/clac Bronze avec clapet en céramique \ Universal-Ablaufgarnitur Click-Clack Bronze mit Keramikstopfen \ Универсальный донный клапан click/clack бронза с керамической крышкой</p>	PIL01BR(X)*	0,40	 <b>Gloss White</b>  <b>Le Terre di Cielo</b>  <b>Le Acque di Cielo</b>	<b>135,00</b> <b>182,00</b> <b>182,00</b>
 <p><b>CHROMED siphon</b> Sifone Cromado \ Siphon Chromé \ Siphon Verchromt \ сифон Chrome</p>	SISP	0,93	 <b>Chrome</b>	<b>133,00</b>
 <p><b>MATT BLACK siphon</b> Sifone Negro Mate \ Siphon Noir Mat \ Siphon Schwarz Matt \ Сифон Черный матовый</p>	SIFN	0,93	 <b>Matt Black</b>	<b>194,00</b>
 <p><b>CEMENTO siphon</b> Sifone Cemento \ Siphon Cemento \ Siphon Cemento \ сифон Cemento</p>	SIFCM	0,93	 <b>Cemento</b>	<b>194,00</b>
 <p><b>BRONZE siphon</b> Sifone Bronce \ Siphon Bronce \ Siphon Bronze \ бронза сифон</p>	SIFBR	0,93	 <b>Bronze</b>	<b>220,00</b>

Terre di Cielo available for washbasins and ceramic shelf / Terre di Cielo disponibles para el lavabo y la encimara de cerámica / Terre di Cielo disponibles pour le lavabo et le plan en céramique / Für Waschbecken und Keramikplatte erhältliche Terre di Cielo / Отделка Terre di Cielo доступны для раковины и керамических столешниц

 TL - Talco	 PM - Pomice	 BR - Brina	 BA - Basalto	 LV - Lavagna
 CM - Cemento	 FN - Fango	 CA - Cacao	 AN - Arenaria	 AV - Avena
 LN - Lino	 AG - Agave	 MU - Muschio	 PL - Polvere	 CP - Cipria
 CN - Canapa				

Acque di Cielo available for washbasins and ceramic shelf / Acque di Cielo disponibles para el lavabo y la encimara de cerámica / Acque di Cielo disponibles pour le lavabo et le plan en céramique / Für Waschbecken und Keramikplatte erhältliche Acque di Cielo / Отделка Acque di Cielo доступны для раковины и керамических столешниц

 OL - Oltremare	 SM - Smeraldo	 AL - Alga
 CO - Corallo	 NI - Ninfea	 AM - Anemone

\* Terre di Cielo laquering available for cabinet / lacados Terre di Cielo disponibles para mueble / laquages Terre di Cielo disponibles pour le meuble / Für Möbel erhältliche Lackierungen Terre di Cielo / крашенная отделка Terre di Cielo доступна для ящика и столешницы

 TL - Talco	 PM - Pomice	 BR - Brina	 AN - Arenaria
 BA - Basalto	 MU - Muschio	 AV - Avena	 CM - Cemento











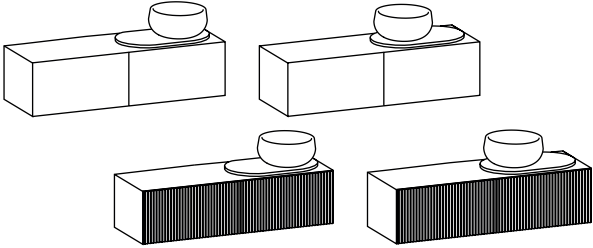





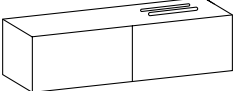

• Oak finishes available for the cabinet - a smooth version and a version with the front door in solid triangular wooden strips / Essence Rovere disponible para el mueble en versión lisa o versión con puerta frontal con tiras de madera maciza triangulares / Essences Chêne disponibles pour le meuble en version lisse et en version avec porte frontale ornée de listels triangulaires en essence de bois massif / Holzarten Eiche für das Möbel in glatter Ausführung und in der Ausführung mit Fronttür aus dreieckigen Massivholzleisten erhältlich / Натуральные шпоны дуба доступны для тумбы с гладкой поверхностью и тумбы с передней дверцей из массива бруса треугольной формы из натурального шпона дерева

 RS - Rovere Sbiancato	 RN - Rovere Naturale
 RG - Rovere Grigio	 RO - Rovere Nero

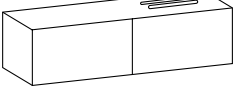
# Delfo 152

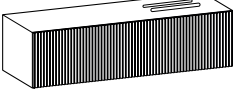
# cielo

Ready-made for a washbasin on the right \ preparado para lavabo a la derecha \ pour lavabo droit \ mit Vorbereitung für ein Waschbecken rechts \ мебель с ровным фасадом, раковина справа

	<b>Size (cm)</b> Medidas Dimensions Maße Размеры	<b>Product code</b> Artículo Article Artikel Артикул	<b>Net weight (kg)</b> Peso neto Poids net Reingewicht вес нетто	<b>Finishes</b> Acabados Finitions Farbe Отделки	<b>Euro</b> Евро
 <p><b>Round on top bowl</b> </p> <p>Cubela de apoio ronda                      Vasque à poser tour                      Aufsatzbecken Runde                      Раковина круглый</p>	43 x 43 x 19 h	BATO(X)*	10,30	<ul style="list-style-type: none"> <li> <b>Gloss White</b></li> <li> <b>Le Terre di Cielo</b></li> <li> <b>Le Acque di Cielo</b></li> </ul>	427,00 697,00 697,00
 <p><b>Ceramic oval countertop, reversible</b> </p> <p>Top ovalado en cerámica reversible \ Plan ovale en céramique reversibel \ Ovale Platte aus Keramik reversibel \ Овальная керамическая столешница</p>	72 x 45,5 x 2h	DEPI076(X)*	12,00	<ul style="list-style-type: none"> <li> <b>Gloss White</b></li> <li> <b>Le Terre di Cielo</b></li> <li> <b>Le Acque di Cielo</b></li> </ul>	388,00 460,00 460,00
<p><b>N.B. Tap/Faucet hole on request (mandatory position – see technical data sheet and order form).</b> \ Orificio grifo a petición (posición obligada-veáse ficha técnica y módulo de pedido) \ N.B. : Trou de robinet sur demande (position obligée – voir fiche technique et bon de commande) \ Hinweis: Hahnloch auf Anfrage (Position obligatorisch – siehe technisches Datenblatt und Bestellformular) \ P.S. Отверстие под смеситель по запросу (возможное место расположения отверстия – проверьте на технической карте изделия и модуле заказа)</p>					
 <p><b>Lacquered cabinet ready-made for a washbasin on the right</b> </p> <p>Mueble lacado preparado para lavabo a la derecha \ Meuble laqué pour lavabo droit \ Möbel lackiert mit Vorbereitung für ein Waschbecken rechts \ Мебель крашенная с установкой раковины справа</p>	152 x 48 x 40h	DEC152DXL(X)*	68,00	<ul style="list-style-type: none"> <li> <b>Le Terre di Cielo *</b></li> </ul>	2580,00
 <p><b>Cabinet in wooden finish ready-made for a washbasin on the right</b></p> <p>Mueble en madera preparado para lavabo a la derecha \ Meuble bois pour lavabo droit \ Möbel aus Holz mit Vorbereitung für ein Waschbecken rechts \ Тумба в деревянной отделке раковина справа</p>	152 x 48 x 40h	DEC152DXE(X)*	68,00	<ul style="list-style-type: none"> <li> <b>EsSENZE ROVERE •</b></li> <li> <b>*X = EU - Eucalipto</b></li> </ul>	3381,00 3704,00
 <p><b>Cabinet with front drawer in solid triangular wooden strips ready-made for a washbasin on the right</b> </p> <p>Mueble con frontal de cajón en listones triangulares de madera maciza en madera, preparado para un lavabo a la derecha \ Armoire avec façade de tiroir en bandes de bois massif triangulaires en essence pour lavabo droit \ Möbel mit Frontschublade aus dreieckigen Massivholzleisten für ein Waschbecken rechts \ Тумба с вертикальными планками из цельного дерева на фасаде, раковина справа</p>	152 x 50 x 40h	DECD152DXE(X)*	66,00	<ul style="list-style-type: none"> <li> <b>EsSENZE ROVERE •</b></li> <li> <b>*X = EU - Eucalipto</b></li> </ul>	7161,00 7730,00

**mandatory combination: on top Cielo washbasin + top + cabinet with holes**

combinaison obligatoire: cubela de apoio Cielo + encimera + mueble los agujeros \ combinación obligatoria: vasque à poser Cielo + plan + meuble con orifice \ obligatorische Kombination: Aufsatzbecken Cielo + Holzregal + Möbel mit Hahnloch \ обязательное сочетание: Накладная Cielo + столешница + Тумба с отверстиями

























**Technical symbols legend**  
 Símbolos técnicos clave / Légende symboles techniques / Technische Zeichenerklärung / Перечень технических символов

 **all sides are enamelled**  
 con todos los lados esmaltados / avec tous les côtés émaillés / alle Seiten glasiert / все стороны покрыты эмалью

 **no tap holes**  
 sin agujero para grifo / sans orifice robinet / ohne Hahnloch / без отверстия под смеситель

 **without overflow**  
 sin rebosadero / sans trop-plein / ohne Überlauf / без слива-перелива

 **on top installation**  
 instalación de apoyo / installation à partir du plan / Montage auf Platte / установка на столешницу

	Product code Artículo Article Artikel Артикул	Net weight(Kg) Peso neto Poids net Reingewicht вес нетто	Finishes Acabados Finitions Farbe Отделки	Euro Евро
 <p><b>Universal click/clack drain in CHROME with ceramic lid</b> Válvula universal click/clack Cromado con tapa en cerámica \ Bonde universelle clic/clac Chromé avec clapet en céramique \ Universal-Ablaufgarnitur Click-Clack Chrom mit Keramikstopfen \ Универсальный донный клапан click/clack хром с керамической крышкой</p>	PIL01(X)*	0,40	 <b>Gloss White</b>  <b>Le Terre di Cielo</b>  <b>Le Acque di Cielo</b>	<b>95,00</b> <b>139,00</b> <b>139,00</b>
 <p><b>Universal click/clack drain in BLACK MATT finish with ceramic lid</b> Válvula universal click/clack Negro Matt con tapa en cerámica \ Bonde universelle clic/clac Noir Matt avec clapet en céramique \ Universal-Ablaufgarnitur Click-Clack Matt Schwarz mit Keramikstopfen \ Универсальный донный клапан click/clack черный матовый с керамической крышкой</p>	PIL01NM(X)*	0,40	 <b>Gloss White</b>  <b>Le Terre di Cielo</b>  <b>Le Acque di Cielo</b>	<b>120,00</b> <b>169,00</b> <b>169,00</b>
 <p><b>Universal click/clack drain in CEMENTO finish with ceramic lid</b> Válvula universal click/clack Cemento con tapa en cerámica \ Bonde universelle clic/clac Cemento avec clapet en céramique \ Universal-Ablaufgarnitur Click-Clack Cement mit Keramikstopfen \ Универсальный донный Cemento click/clack с керамической крышкой</p>	PIL01CM(X)*	0,40	 <b>Gloss White</b>  <b>Le Terre di Cielo</b>  <b>Le Acque di Cielo</b>	<b>120,00</b> <b>169,00</b> <b>169,00</b>
 <p><b>Universal click/clack drain in BRONZE with ceramic lid</b> Válvula universal click/clack Bronce con tapa en cerámica \ Bonde universelle clic/clac Bronce avec clapet en céramique \ Universal-Ablaufgarnitur Click-Clack Bronze mit Keramikstopfen \ Универсальный донный клапан click/clack бронза с керамической крышкой</p>	PIL01BR(X)*	0,40	 <b>Gloss White</b>  <b>Le Terre di Cielo</b>  <b>Le Acque di Cielo</b>	<b>135,00</b> <b>182,00</b> <b>182,00</b>
 <p><b>CHROMED siphon</b> Sifone Cromado \ Siphon Chromé \ Siphon Verchromt \ сифон Chrome</p>	SISP	0,93	 <b>Chrome</b>	<b>133,00</b>
 <p><b>MATT BLACK siphon</b> Sifone Negro Mate \ Siphon Noir Mat \ Siphon Schwarz Matt \ Сифон Черный матовый</p>	SIFN	0,93	 <b>Matt Black</b>	<b>194,00</b>
 <p><b>CEMENTO siphon</b> Sifone Cemento \ Siphon Cemento \ Siphon Cemento \ сифон Cemento</p>	SIFCM	0,93	 <b>Cemento</b>	<b>194,00</b>
 <p><b>BRONZE siphon</b> Sifone Bronce \ Siphon Bronze \ Siphon Bronze \ бронза сифон</p>	SIFBR	0,93	 <b>Bronze</b>	<b>220,00</b>

Terre di Cielo available for washbasins and ceramic shelf | Terre di Cielo disponibles para el lavabo y la encimara de cerámica | Terre di Cielo disponibles pour le lavabo et le plan en céramique | Für Waschbecken und Keramikplatte erhältlich Terre di Cielo | Отделка Terre di Cielo доступны для раковины и керамических столешниц

-  TL - Talco
-  PM - Pomice
-  BR - Brina
-  BA - Basalto
-  LV - Lavagna
-  CM - Cemento
-  FN - Fango
-  CA - Cacao
-  AN - Arenaria
-  AV - Avena
-  LN - Lino
-  AG - Agave
-  MU - Muschio
-  PL - Polvere
-  CP - Cipria
-  CN - Canapa

Acque di Cielo available for washbasins and ceramic shelf | Acque di Cielo disponibles para el lavabo y la encimara de cerámica | Acque di Cielo disponibles pour le lavabo et le plan en céramique | Für Waschbecken und Keramikplatte erhältlich Acque di Cielo | Отделка Acque di Cielo доступны для раковины и керамических столешниц

-  OL - Oltremare
-  SM - Smeraldo
-  AL - Alga
-  CO - Corallo
-  NI - Ninfea
-  AM - Anemone

\* Terre di Cielo laquering available for cabinet | lacados Terre di Cielo disponibles para mueble | laquages Terre di Cielo disponibles pour le meuble | Für Möbel erhältliche Lackierungen Terre di Cielo | крашеная отделка Terre di Cielo доступна для ящика и столешницы

-  TL - Talco
-  PM - Pomice
-  BR - Brina
-  AN - Arenaria
-  BA - Basalto
-  MU - Muschio
-  AV - Avena
-  CM - Cemento





• Oak finishes available for the cabinet - a smooth version and a version with the front door in solid triangular wooden strips | Essenze Rovere disponibile para el mueble en versión lisa o versión con puerta frontal con tiras de madera maciza triangulares | Essences Chêne disponibles pour le meuble en version lisse et en version avec porte frontale ornée de listels triangulaires en essence de bois massif | Holzarten Eiche für das Möbel in glatter Ausführung und in der Ausführung mit Fronttür aus dreieckigen Massivholzleisten erhältlich | Натуральные шпоны дуба доступны для тумбы с гладкой поверхностью и тумбы с передней дверцей из массива бруса треугольной формы из натурального шпона дерева

-  RS - Rovere Sbiancato
-  RN - Rovere Naturale
-  RG - Rovere Grigio
-  RO - Rovere Nero

# Delfo 152

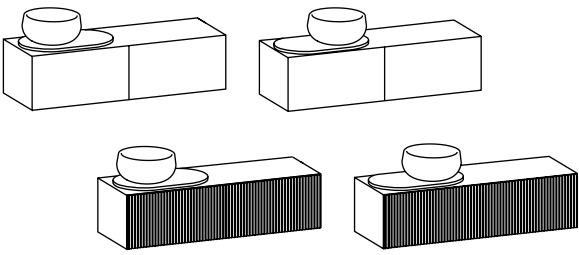
ready-made for a washbasin on the left \ preparado para lavabo a la izquierda \ pour lavabo gauche \ mit Vorbereitung für ein Waschbecken links \ мебель с ровным фасадом, раковина слева

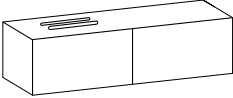
# cielo

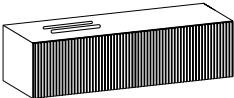
	<b>Size (cm)</b> Medidas Dimensions Maße Размеры	<b>Product code</b> Artículo Article Artikel Артикул	<b>Net weight (kg)</b> Peso neto Poids net Reingewicht вес нетто	<b>Finishes</b> Acabados Finitions Farbe Отделки	<b>Euro</b> Евро
 <p><b>Round on top bowl</b>                      Cubela de apoio ronda                      Vasque à poser tour                      Aufsatzbecken Runde                      Раковина круглый</p>	43 x 43 x 19 h	BATO(X)*	10,30	<input type="radio"/> Gloss White <input checked="" type="radio"/> Le Terre di Cielo <input checked="" type="radio"/> Le Acque di Cielo	427,00 697,00 697,00
 <p><b>Ceramic oval countertop, reversible</b> \ Top ovalado en cerámica reversible \ Plan ovale en céramique reversibel \ Ovale Platte aus Keramik reversibel \ Овальная керамическая столешница</p>	72 x 45,5 x 2h	DEPIO76(X)*	12,00	<input type="radio"/> Gloss White <input checked="" type="radio"/> Le Terre di Cielo <input checked="" type="radio"/> Le Acque di Cielo	388,00 460,00 460,00
<p><b>N.B. Tap/Faucet hole on request (mandatory position – see technical data sheet and order form).</b> \ Orificio grifo a petición (posición obligada-veáse ficha técnica y módulo de pedido) \ N.B. : Trou de robinet sur demande (position obligée – voir fiche technique et bon de commande) \ Hinweis: Hahnloch auf Anfrage (Position obligatorisch – siehe technisches Datenblatt und Bestellformular) \ P.S. Отверстие под смеситель по запросу (возможное место расположения отверстия – проверьте на технической карте изделия и модуле заказа)</p>					
 <p><b>Lacquered cabinet ready-made for a washbasin on the left</b>                      Mueble lacado preparado para lavabo a la izquierda \ Meuble laqué pour lavabo gauche \ Möbel lackiert mit Vorbereitung für ein Waschbecken links \ Мебель крашенная с установкой раковины слева</p>	152 x 48 x 40h	DEC152SXL(X)*	68,00	<input checked="" type="radio"/> Le Terre di Cielo *	2580,00
 <p><b>Cabinet in wooden finish ready-made for a washbasin on the left</b>                      Mueble en madera preparado para lavabo a la izquierda \ Meuble bois pour lavabo gauche \ Möbel aus Holz mit Vorbereitung für ein Waschbecken links \ Тумба в деревянной отделке, раковина слева</p>	152 x 48 x 40h	DEC152SXE(X)*	68,00	<input checked="" type="radio"/> Essenze Rovere • <input checked="" type="radio"/> *X = EU - Eucalipto	3381,00 3704,00
 <p><b>Cabinet with front drawer in solid triangular wooden strips ready-made for a washbasin on the left</b>                      Mueble con frontal de cajón en listones triangulares de madera maciza en madera, preparado para un lavabo a la izquierda \ Armoire avec façade de tiroir en bandes de bois massif triangulaires en essence pour lavabo gauche \ Möbel mit Frontschublade aus dreieckigen Massivholzleisten für ein Waschbecken links \ Тумба с вертикальными планками из цельного дерева на фасаде, раковина слева</p>	152 x 50 x 40h	DECD152SXE(X)*	66,00	<input checked="" type="radio"/> Essenze Rovere • <input checked="" type="radio"/> *X = EU - Eucalipto	7161,00 7730,00

**mandatory combination: on top Cielo washbasin + top + cabinet with holes**

combinaison obligatoire: cubela de apoio Cielo + encimera + mueble los agujeros \ combinación obligatoria: vasque à poser Cielo + plan + meuble con orifice \ obligatorische Kombination: Aufsatzbecken Cielo + Holzregal + Möbel mit Hahnloch \ обязательное сочетание: Накладная Cielo + столешница + Тумба с отверстиями

**Technical symbols legend**

























Simbolos técnicos clave / Légende symboles techniques / Technische Zeichenerklärung / Перечень технических символов

 all sides are enamelled con todos los lados esmaltados avec tous les côtés émaillés alle Seiten glasiert все стороны покрыты эмалью

 no tap holes sin agujero para grifo sans orifice robinet ohne Hahnloch без отверстия под смеситель

 without overflow sin rebosadero sans trop-plein ohne Überlauf без слива-перелива

 on top installation instalación de apoyo installation à partir du plan Montage auf Platte установка на столешницу

	Product code Artículo Article Artikel Артикул	Net weight (Kg) Peso neto Poids net Reingewicht вес нетто	Finishes Acabados Finitions Farbe Отделка	Euro Евро
 <p><b>Universal click/clack drain in CHROME with ceramic lid</b> Válvula universal click/clack Cromado con tapa en cerámica \ Bonde universelle clic/clac Chromé avec clapet en céramique \ Universal-Ablaufgarnitur Click-Clack Chrom mit Keramikstopfen \ Универсальный донный клапан click/clack хром с керамической крышкой</p>	PIL01(X)*	0,40	 <b>Gloss White</b>  <b>Le Terre di Cielo</b>  <b>Le Acque di Cielo</b>	<b>95,00</b> <b>139,00</b> <b>139,00</b>
 <p><b>Universal click/clack drain in BLACK MATT finish with ceramic lid</b> Válvula universal click/clack Negro Matt con tapa en cerámica \ Bonde universelle clic/clac Noir Matt avec clapet en céramique \ Universal-Ablaufgarnitur Click-Clack Matt Schwarz mit Keramikstopfen \ Универсальный донный клапан click/clack черный матовый с керамической крышкой</p>	PIL01NM(X)*	0,40	 <b>Gloss White</b>  <b>Le Terre di Cielo</b>  <b>Le Acque di Cielo</b>	<b>120,00</b> <b>169,00</b> <b>169,00</b>
 <p><b>Universal click/clack drain in CEMENTO finish with ceramic lid</b> Válvula universal click/clack Cemento con tapa en cerámica \ Bonde universelle clic/clac Cemento avec clapet en céramique \ Universal-Ablaufgarnitur Click-Clack Cement mit Keramikstopfen \ Универсальный донный Cemento click/clack с керамической крышкой</p>	PIL01CM(X)*	0,40	 <b>Gloss White</b>  <b>Le Terre di Cielo</b>  <b>Le Acque di Cielo</b>	<b>120,00</b> <b>169,00</b> <b>169,00</b>
 <p><b>Universal click/clack drain in BRONZE with ceramic lid</b> Válvula universal click/clack Bronce con tapa en cerámica \ Bonde universelle clic/clac Bronce avec clapet en céramique \ Universal-Ablaufgarnitur Click-Clack Bronze mit Keramikstopfen \ Универсальный донный клапан click/clack бронза с керамической крышкой</p>	PIL01BR(X)*	0,40	 <b>Gloss White</b>  <b>Le Terre di Cielo</b>  <b>Le Acque di Cielo</b>	<b>135,00</b> <b>182,00</b> <b>182,00</b>
 <p><b>CHROMED siphon</b> Sifone Cromado \ Siphon Chromé \ Siphon Verchromt \ сифон Chrome</p>	SISP	0,93	 <b>Chrome</b>	<b>133,00</b>
 <p><b>MATT BLACK siphon</b> Sifone Negro Mate \ Siphon Noir Mat \ Siphon Schwarz Matt \ Сифон Черный матовый</p>	SIFN	0,93	 <b>Matt Black</b>	<b>194,00</b>
 <p><b>CEMENTO siphon</b> Sifone Cemento \ Siphon Cemento \ Siphon Cimento \ сифон Cemento</p>	SIFCM	0,93	 <b>Cemento</b>	<b>194,00</b>
 <p><b>BRONZE siphon</b> Sifone Bronce \ Siphon Bronce \ Siphon Bronze \ бронза сифон</p>	SIFBR	0,93	 <b>Bronze</b>	<b>220,00</b>

Terre di Cielo available for washbasins and ceramic shelf | Terre di Cielo disponibles para el lavabo y la encimera de cerámica | Terre di Cielo disponibles pour le lavabo et le plan en céramique | Für Waschbecken und Keramikplatte erhältliche Terre di Cielo | Отделка Terre di Cielo доступны для раковины и керамических столешниц

 TL - Talco	 PM - Pomice	 BR - Brina	 BA - Basalto	 LV - Lavagna
 CM - Cemento	 FN - Fango	 CA - Cacao	 AN - Arenaria	 AV - Avena
 LN - Lino	 AG - Agave	 MU - Muschio	 PL - Polvere	 CP - Cipria
 CN - Canapa				

Acque di Cielo available for washbasins and ceramic shelf | Acque di Cielo disponibles para el lavabo y la encimera de cerámica | Acque di Cielo disponibles pour le lavabo et le plan en céramique | Für Waschbecken und Keramikplatte erhältliche Acque di Cielo | Отделка Acque di Cielo доступны для раковины и керамических столешниц

 OL - Oltremare	 SM - Smeraldo	 AL - Alga
 CO - Corallo	 NI - Ninfea	 AM - Anemone

\* Terre di Cielo laquering available for cabinet | lacados Terre di Cielo disponibles para mueble | laquages Terre di Cielo disponibles pour le meuble | Für Möbel erhältliche Lackierungen Terre di Cielo | крашеная отделка Terre di Cielo доступна для ящика и столешницы

 TL - Talco	 PM - Pomice	 BR - Brina	 AN - Arenaria
 BA - Basalto	 MU - Muschio	 AV - Avena	 CM - Cemento

• Oak finishes available for the cabinet - a smooth version and a version with the front door in solid triangular wooden strips | Essenze Rovere disponibile para el mueble en versión lisa o versión con puerta frontal con tiras de madera maciza triangulares | Essences Chêne disponibles pour le meuble en version lisse et en version avec porte frontale ornée de listels triangulaires en essence de bois massif | Holzarten Eiche für das Möbel in glatter Ausführung und in der Ausführung mit Fronttür aus dreieckigen Massivholzleisten erhältlich | Натуральные шпоны дуба доступны для тумбы с гладкой поверхностью и тумбы с передней дверцей из массива бруса треугольной формы из натурального шпона дерева











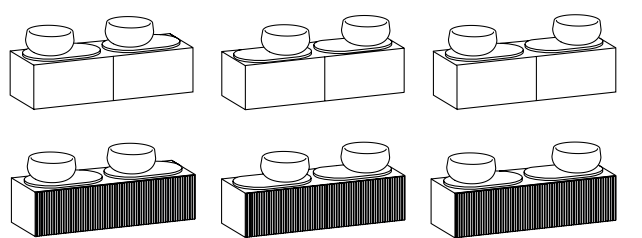







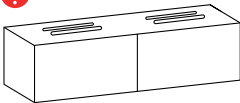

 RS - Rovere Sbiancato	 RN - Rovere Naturale
 RG - Rovere Grigio	 RO - Rovere Nero

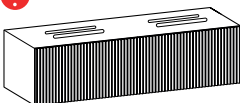

# Delfo 152

ready-made for two washbasins \ preparado para dos lavabos \ pour deux lavabos \ mit Vorbereitung für zwei Waschbecken \ мебель с ровным фасадом, на 2-е раковины

# cielo

	<b>Size (cm)</b> Medidas Dimensions Maße Размеры	<b>Product code</b> Artículo Article Artikel Артикул	<b>Net weight (kg)</b> Peso neto Poids net Reingewicht вес нетто	<b>Finishes</b> Acabados Finitions Farbe Отделки	<b>Euro</b> Евро
 <p><b>Round on top bowl</b> </p> <p>Cubela de apoio ronda                      Vasque à poser tour                      Aufsatzbecken Runde                      Раковина круглый</p>	43 x 43 x 19 h	BATO(X)*	10,30	<ul style="list-style-type: none"> <li> <b>Gloss White</b></li> <li> <b>Le Terre di Cielo</b></li> <li> <b>Le Acque di Cielo</b></li> </ul>	427,00 697,00 697,00
 <p><b>Ceramic oval countertop, reversible</b> </p> <p>Top ovalado en cerámica reversible \ Plan ovale en céramique réversible \ Ovale Platte aus Keramik reversibel \ Овальная керамическая столешница</p> <p><b>N.B. Tap/Faucet hole on request (mandatory position – see technical data sheet and order form).</b> \ Orificio grifo a petición (posición obligada-veáse ficha técnica y módulo de pedido) \ N.B. : Trou de robinet sur demande (position obligée – voir fiche technique et bon de commande) \ Hinweis: Hahnloch auf Anfrage (Position obligatorisch – siehe technisches Datenblatt und Bestellformular) \ P.S. Отверстие под смеситель по запросу (возможное место расположения отверстия – проверьте на технической карте изделия и модуле заказа)</p>	72 x 45,5 x 2h	DEPI076(X)*	12,00	<ul style="list-style-type: none"> <li> <b>Gloss White</b></li> <li> <b>Le Terre di Cielo</b></li> <li> <b>Le Acque di Cielo</b></li> </ul>	388,00 460,00 460,00 25,00
 <p><b>Lacquered cabinet ready-made for two washbasins</b> </p> <p>Mueble lacado preparado para dos lavabos \ Meuble laqué pour deux lavabos \ Möbel lackiert mit Vorbereitung für zwei Waschbecken \ Мебель крашенная с установкой 2-х раковин</p>	152 x 48 x 40h	DEC152L(X)*	68,00	<ul style="list-style-type: none"> <li> <b>Le Terre di Cielo *</b></li> </ul>	2580,00
 <p><b>Cabinet in wooden finish ready-made for two washbasins</b> </p> <p>Mueble en madera preparado para dos lavabos \ Meuble bois pour deux lavabos \ Möbel aus Holz mit Vorbereitung für zwei Waschbecken \ Тумба в деревянной отделке на 2-е раковины</p>	152 x 48 x 40h	DEC152E(X)*	68,00	<ul style="list-style-type: none"> <li> <b>EsSENze Rovere •</b></li> <li> <b>*X = EU - Eucalipto</b></li> </ul>	3381,00 3704,00
 <p><b>Cabinet with front drawer in solid triangular wooden strips ready-made for two washbasins</b> </p> <p>Mueble con frontal de cajón en listones triangulares de madera maciza en madera, preparado para dos lavabos \ Armoire avec façade de tiroir en bandes de bois massifs triangulaires en essence pour deux lavabos \ Möbel mit Frontschublade aus dreieckigen Massivholzleisten für zwei Waschbecken \ Тумба с вертикальными планками из цельного дерева на фасаде, на 2-е раковины</p>	152 x 50 x 40h	DECD152E(X)*	66,00	<ul style="list-style-type: none"> <li> <b>EsSENze Rovere •</b></li> <li> <b>*X = EU - Eucalipto</b></li> </ul>	7161,00 7730,00

**mandatory combination: on top Cielo washbasin + top + cabinet with holes**

 combinaison obligatoire: cubela de apoio Cielo + encimera + mueble los agujeros \ combinación obligatoria: vasque à poser Cielo + plan + meuble con orifice \ obligatorische Kombination: Aufsatzbecken Cielo + Holzregal + Möbel mit Hahnloch \ обязательное сочетание: Накладная Cielo + столешница + Тумба с оп отверстия

**Technical symbols**

























**Legend**  
*Símbolos técnicos clave / Légende symboles techniques / Technische Zeichenerklärung / Перечень технических символов*

 **all sides are enamelled**  
 con todos los lados esmaltados  
 avec tous les côtés émaillés  
 alle Seiten glasiert  
 все стороны покрыты эмалью

 **no tap holes**  
 sin agujero para grifo  
 sans orifice robinet  
 ohne Hahnloch  
 без отверстия под смеситель

 **without overflow**  
 sin rebosadero  
 sans trop-plein  
 ohne Überlauf  
 без слива-перелива

 **on top installation**  
 instalación de apoyo  
 installation à partir du plan  
 Montage auf Platte  
 установка на столешницу

	Product code Artículo Article Artikel Артикул	Net weight(Kg) Peso neto Poids net Reingewicht вес нетто	Finishes Acabados Finitions Farbe Отделка	Euro Евро
 <p><b>Universal click/clack drain in CHROME with ceramic lid</b> Válvula universal click/clack Cromado con tapa en cerámica \ Bonde universelle clic/clac Chromé avec clapet en céramique \ Universal-Ablaufgarnitur Click-Clack Chrom mit Keramikstopfen \ Универсальный донный клапан click/clack хром с керамической крышкой</p>	PIL01(X)*	0,40	 <b>Gloss White</b>  <b>Le Terre di Cielo</b>  <b>Le Acque di Cielo</b>	<b>95,00</b> <b>139,00</b> <b>139,00</b>
 <p><b>Universal click/clack drain in BLACK MATT finish with ceramic lid</b> Válvula universal click/clack Negro Matt con tapa en cerámica \ Bonde universelle clic/clac Noir Matt avec clapet en céramique \ Universal-Ablaufgarnitur Click-Clack Matt Schwarz mit Keramikstopfen \ Универсальный донный клапан click/clack черный матовый с керамической крышкой</p>	PIL01NM(X)*	0,40	 <b>Gloss White</b>  <b>Le Terre di Cielo</b>  <b>Le Acque di Cielo</b>	<b>120,00</b> <b>169,00</b> <b>169,00</b>
 <p><b>Universal click/clack drain in CEMENTO finish with ceramic lid</b> Válvula universal click/clack Cemento con tapa en cerámica \ Bonde universelle clic/clac Cemento avec clapet en céramique \ Universal-Ablaufgarnitur Click-Clack Cement mit Keramikstopfen \ Универсальный донный Cemento click/clack с керамической крышкой</p>	PIL01CM(X)*	0,40	 <b>Gloss White</b>  <b>Le Terre di Cielo</b>  <b>Le Acque di Cielo</b>	<b>120,00</b> <b>169,00</b> <b>169,00</b>
 <p><b>Universal click/clack drain in BRONZE with ceramic lid</b> Válvula universal click/clack Bronce con tapa en cerámica \ Bonde universelle clic/clac Bronce avec clapet en céramique \ Universal-Ablaufgarnitur Click-Clack Bronze mit Keramikstopfen \ Универсальный донный клапан click/clack бронза с керамической крышкой</p>	PIL01BR(X)*	0,40	 <b>Gloss White</b>  <b>Le Terre di Cielo</b>  <b>Le Acque di Cielo</b>	<b>135,00</b> <b>182,00</b> <b>182,00</b>
 <p><b>CHROMED siphon</b> Sifone Cromado \ Siphon Chromé \ Siphon Verchromt \ сифон Chrome</p>	SISP	0,93	 <b>Chrome</b>	<b>133,00</b>
 <p><b>MATT BLACK siphon</b> Sifone Negro Mate \ Siphon Noir Mat \ Siphon Schwarz Matt \ Сифон Черный матовый</p>	SIFN	0,93	 <b>Matt Black</b>	<b>194,00</b>
 <p><b>CEMENTO siphon</b> Sifone Cemento \ Siphon Cemento \ Siphon Cemento \ сифон Cemento</p>	SIFCM	0,93	 <b>Cemento</b>	<b>194,00</b>
 <p><b>BRONZE siphon</b> Sifone Bronce \ Siphon Bronze \ Siphon Bronze \ бронза сифон</p>	SIFBR	0,93	 <b>Bronze</b>	<b>220,00</b>

Terre di Cielo available for washbasins and ceramic shelf | Terre di Cielo disponibles para el lavabo y la encimara de cerámica | Terre di Cielo disponibles pour le lavabo et le plan en céramique | Für Waschbecken und Keramikplatte erhältlich Terre di Cielo | Отделка Terre di Cielo доступны для раковины и керамических столешниц

-  TL - Talco
-  PM - Pomice
-  BR - Brina
-  BA - Basalto
-  LV - Lavagna
-  CM - Cemento
-  FN - Fango
-  CA - Cacao
-  AN - Arenaria
-  AV - Avena
-  LN - Lino
-  AG - Agave
-  MU - Muschio
-  PL - Polvere
-  CP - Cipria
-  CN - Canapa

Acque di Cielo available for washbasins and ceramic shelf | Acque di Cielo disponibles para el lavabo y la encimara de cerámica | Acque di Cielo disponibles pour le lavabo et le plan en céramique | Für Waschbecken und Keramikplatte erhältlich Acque di Cielo | Отделка Acque di Cielo доступны для раковины и керамических столешниц

-  OL - Oltremare
-  SM - Smeraldo
-  AL - Alga
-  CO - Corallo
-  NI - Ninfea
-  AM - Anemone

\* Terre di Cielo laquering available for cabinet | lacados Terre di Cielo disponibles para mueble | laquages Terre di Cielo disponibles pour le meuble | Für Möbel erhältlich Lackierungen Terre di Cielo | крашенная отделка Terre di Cielo доступна для ящика и столешницы

-  TL - Talco
-  PM - Pomice
-  BR - Brina
-  AN - Arenaria
-  BA - Basalto
-  MU - Muschio
-  AV - Avena
-  CM - Cemento

• Oak finishes available for the cabinet - a smooth version and a version with the front door in solid triangular wooden strips | Essenze Rovere disponibile para el mueble en versión lisa o versión con puerta frontal con tiras de madera maciza triangulares | Essences Chêne disponibles pour le meuble en version lisse et en version avec porte frontale ornée de listels triangulaires en essence de bois massif | Holzarten Eiche für das Möbel in glatter Ausführung und in der Ausführung mit Fronttür aus dreieckigen Massivholzleisten erhältlich | Натуральные шпона дуба доступны для тумбы с гладкой поверхностью и тумбы с передней дверцей из массива бруса треугольной формы из натурального шпона дерева

-  RS - Rovere Sbiancato
-  RN - Rovere Naturale
-  RG - Rovere Grigio
-  RO - Rovere Nero

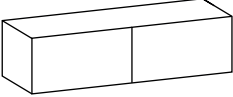
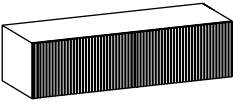
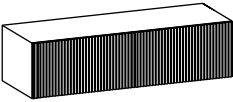
	Size (cm) Medidas Dimensions Maße Размеры	Product code Artículo Article Artikel Артикул	Net weight (kg) Peso neto Poids net Reingewicht вес нетто	Finishes Acabados Finitions Farbe Отделки	Euro Евро
 <p><b>Lacquered cabinet without holes</b> Mueble lacado sin agujero \ Meuble laqué sans orifice \ Möbel lackiert ohne Hahnloch \ Тумба крашенная без отверстия</p>	152 x 48 x 40h	DEC152LSF(X)*	68,00	● <b>Le Terre di Cielo *</b>	<b>2580,00</b>
	 <p><b>Cabinet in wooden finish without holes</b> Mueble en madera sin agujero \ Meuble bois sans orifice \ Möbel aus Holz ohne Hahnloch \ Тумба в деревянной отделке без отверстия</p>	152 x 48 x 40h	DEC152ESF(X)*	68,00	● <b>EsSENze Rovere •</b> ● *X = EU - Eucalipto
 <p><b>Cabinet with front drawer in solid triangular wooden strips without holes</b> Mueble con frontal de cajón en listones triangulares de madera maciza en madera sin agujero \ Armoire avec façade de tiroir en bandes de bois massif triangulaires en essence sans orifice \ Möbel mit Frontschublade aus dreieckigen Massivholzleisten ohne Hahnloch \ Тумба с вертикальными планками из цельного дерева на фасаде, без отверстия</p>		152 x 50 x 40h	DECD152ESF(X)*	66,00	● <b>EsSENze Rovere •</b> ● *X = EU - Eucalipto

\* **Terre di Cielo laquering available for cabinet** | lacados Terre di Cielo disponibles para mueble | laquages Terre di Cielo disponibles pour le meuble | Für Möbel erhältliche Lackierungen Terre di Cielo | крашенная отделка Terre di Cielo доступна для ящика и столешницы

● TL - Talco ● PM - Pomice ● BR - Brina ● AN - Arenaria  
● BA - Basalto ● MU - Muschio ● AV - Avena ● CM - Cemento

● **Oak finishes available for the cabinet - a smooth version and a version with the front door in solid triangular wooden strips** | EsSENze Rovere disponible para el mueble en versión lisa o versión con puerta frontal con tiras de madera maciza triangulares | Essences Chêne disponibles pour le meuble en version lisse et en version avec porte frontale ornée de listels triangulaires en essence de bois massif | Holzarten Eiche für das Möbel in glatter Ausführung und in der Ausführung mit Fronttür aus dreieckigen Massivholzleisten erhältlich | **Натуральные шпоны дуба доступны для тумбы с гладкой поверхностью и тумбы с передней дверцей из массива бруса треугольной формы из натурального шпона дерева**











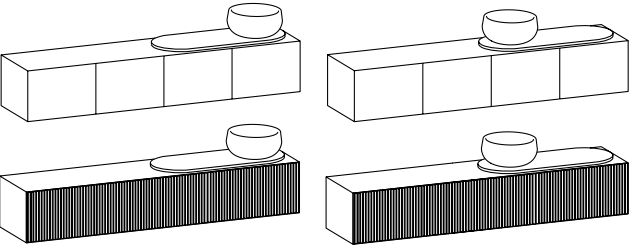







● RS - Rovere Sbiancato ● RN - Rovere Naturale ● RG - Rovere Grigio ● RO - Rovere Nero

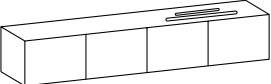

# Delfo 226

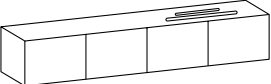
# cielo

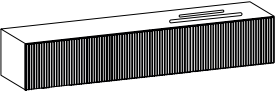
Ready-made for a washbasin on the right \ preparado para lavabo a la derecha \ pour lavabo droit \ mit Vorbereitung für ein Waschbecken rechts \ мебель с ровным фасадом, раковина справа

	<b>Size (cm)</b> Medidas Dimensions Maße Размеры	<b>Product code</b> Artículo Article Artikel Артикул	<b>Net weight (kg)</b> Peso neto Poids net Reingewicht вес нетто	<b>Finishes</b> Acabados Finitions Farbe Отделка	<b>Euro</b> Евро
 <p><b>Round on top bowl</b>    </p> <p>Cubeta de apoyo ronda                      Vasque à poser tour                      Aufsatzbecken Runde                      Раковина круглый</p>	43 x 43 x 19 h	BATO(x)*	10,30	<ul style="list-style-type: none"> <li> <b>Gloss White</b></li> <li> <b>Le Terre di Cielo</b></li> <li> <b>Le Acque di Cielo</b></li> </ul>	427,00 697,00 697,00
 <p><b>Ceramic oval countertop, reversible</b> \ Top ovalado en cerámica reversible \ Plan ovale en céramique reversible \ Ovale Platte aus Keramik reversibel \ Овальная керамическая столешница</p> <p><b>N.B. Tap/Faucet hole on request (mandatory position – see technical data sheet and order form).</b> \ Orificio grifo a petición (posición obligada-veáse ficha técnica y módulo de pedido) \ N.B. : Trou de robinet sur demande (position obligée – voir fiche technique et bon de commande) \ Hinweis: Hahnloch auf Anfrage (Position obligatorisch – siehe technisches Datenblatt und Bestellformular) \ P.S. Отверстие под смеситель по запросу (возможное место расположения отверстия – проверьте на технической карте изделия и модуле заказа)</p>	107 x 47 x 2h	DEPIO(x)*	17,00	<ul style="list-style-type: none"> <li> <b>Gloss White</b></li> <li> <b>Le Terre di Cielo</b></li> <li> <b>Le Acque di Cielo</b></li> </ul>	447,00 486,00 486,00  25,00
 <p><b>Lacquered cabinet ready-made for a washbasin on the right</b></p> <p>Mueble lacado preparado para lavabo a la derecha \ Meuble laqué pour lavabo droit \ Möbel lackiert mit Vorbereitung für ein Waschbecken rechts \ Мебель крашенная с установкой раковины справа</p>	226 x 52 x 40h	DEC226DXL(x)*	91,50	<ul style="list-style-type: none"> <li> <b>Le Terre di Cielo *</b></li> </ul>	3812,00
 <p><b>Cabinet in wooden finish ready-made for a washbasin on the right</b></p> <p>Mueble en madera preparado para lavabo a la derecha \ Meuble bois pour lavabo droit \ Möbel aus Holz mit Vorbereitung für ein Waschbecken rechts \ Тумба в деревянной отделке раковина справа</p>	226 x 52 x 40h	DEC226DXE(x)*	91,50	<ul style="list-style-type: none"> <li> <b>Essenze Rovere •</b></li> <li> <b>*X = EU - Eucalipto</b></li> </ul>	4657,00 5115,00
 <p><b>Cabinet with front drawer in solid triangular wooden strips ready-made for a washbasin on the right</b></p> <p>Mueble con frontal de cajón en listones triangulares de madera maciza en madera, preparado para un lavabo a la derecha \ Armoire avec façade de tiroir en bandes de bois massif triangulaires en essence pour lavabo droit \ Möbel mit Frontschublade aus dreieckigen Massivholzleisten für ein Waschbecken rechts \ Тумба с вертикальными планками из цельного дерева на фасаде, раковина справа</p>	226 x 52 x 40h	DECD226DXE(x)*	89,00	<ul style="list-style-type: none"> <li> <b>Essenze Rovere •</b></li> <li> <b>*X = EU - Eucalipto</b></li> </ul>	9702,00  10.338,00

**mandatory combination: on top Cielo washbasin + top + cabinet with holes**

combinación obligatoria: cubeta de apoyo Cielo + encimera + mueble los agujeros \ combinación obligatoria: vasque à poser Cielo + plan + meuble con orifice \ obligatorische Kombination: Aufsatzbecken Cielo + Holzregal + Möbel mit Hahnloch \ обязательное сочетание: Накладная Cielo + столешница + Тумба с отверстиями

**Technical symbols legend**

Simbolos técnicos clave / Légende symboles techniques / Technische Zeichenerklärung / Перечень технических символов

























 all sides are enamelled con todos los lados esmaltados avec tous les côtés émaillés alle Seiten glasiert все стороны покрыты эмалью

 no tap holes sin agujero para grifo sans orifice robinet ohne Hahnloch без отверстия под смеситель

 without overflow sin rebosadero sans trop-plein ohne Überlauf без слива-перелива

 on top installation instalación de apoyo instalación à partir du plan Montage auf Platte установка на столешницу









	Product code Artículo Article Artikel Артикул	Net weight(Kg) Peso neto Poids net Reingewicht вес нетто	Finishes Acabados Finitions Farbe Отделки	Euro Евро
 <p><b>Universal click/clack drain in CHROME with ceramic lid</b> Válvula universal clic/clack Cromado con tapa en cerámica \ Bonde universelle clic/clac Chromé avec clapet en céramique \ Universal-Ablaufgarnitur Click-Clack Chrom mit Keramikstopfen \ Универсальный донный клапан click/clack хром с керамической крышкой</p>	PIL01(X)*	0,40	<ul style="list-style-type: none"> <li> <b>Gloss White</b></li> <li> <b>Le Terre di Cielo</b></li> <li> <b>Le Acque di Cielo</b></li> </ul>	<p><b>95,00</b></p> <p><b>139,00</b></p> <p><b>139,00</b></p>
 <p><b>Universal click/clack drain in BLACK MATT finish with ceramic lid</b> Válvula universal clic/clack Negro Matt con tapa en cerámica \ Bonde universelle clic/clac Noir Matt avec clapet en céramique \ Universal-Ablaufgarnitur Click-Clack Matt Schwarz mit Keramikstopfen \ Универсальный донный клапан click/clack черный матовый с керамической крышкой</p>	PIL01NM(X)*	0,40	<ul style="list-style-type: none"> <li> <b>Gloss White</b></li> <li> <b>Le Terre di Cielo</b></li> <li> <b>Le Acque di Cielo</b></li> </ul>	<p><b>120,00</b></p> <p><b>169,00</b></p> <p><b>169,00</b></p>
 <p><b>Universal click/clack drain in CEMENTO finish with ceramic lid</b> Válvula universal clic/clack Cemento con tapa en cerámica \ Bonde universelle clic/clac Cemento avec clapet en céramique \ Universal-Ablaufgarnitur Click-Clack Cement mit Keramikstopfen \ Универсальный донный Cemento click/clack с керамической крышкой</p>	PIL01CM(X)*	0,40	<ul style="list-style-type: none"> <li> <b>Gloss White</b></li> <li> <b>Le Terre di Cielo</b></li> <li> <b>Le Acque di Cielo</b></li> </ul>	<p><b>120,00</b></p> <p><b>169,00</b></p> <p><b>169,00</b></p>
 <p><b>Universal click/clack drain in BRONZE with ceramic lid</b> Válvula universal clic/clack Bronce con tapa en cerámica \ Bonde universelle clic/clac Bronce avec clapet en céramique \ Universal-Ablaufgarnitur Click-Clack Bronze mit Keramikstopfen \ Универсальный донный клапан click/clack бронза с керамической крышкой</p>	PIL01BR(X)*	0,40	<ul style="list-style-type: none"> <li> <b>Gloss White</b></li> <li> <b>Le Terre di Cielo</b></li> <li> <b>Le Acque di Cielo</b></li> </ul>	<p><b>135,00</b></p> <p><b>182,00</b></p> <p><b>182,00</b></p>
 <p><b>CHROMED siphon</b> Sifone Cromado \ Siphon Chromé \ Siphon Verchromt \ сифон Chrome</p>	SISP	0,93	<ul style="list-style-type: none"> <li> <b>Chrome</b></li> </ul>	<b>133,00</b>
 <p><b>MATT BLACK siphon</b> Sifone Negro Mate \ Siphon Noir Mat \ Siphon Schwarz Matt \ Сифон Черный матовый</p>	SIFN	0,93	<ul style="list-style-type: none"> <li> <b>Matt Black</b></li> </ul>	<b>194,00</b>
 <p><b>CEMENTO siphon</b> Sifone Cemento \ Siphon Cemento \ Siphon Cemento \ сифон Cemento</p>	SIFCM	0,93	<ul style="list-style-type: none"> <li> <b>Cemento</b></li> </ul>	<b>194,00</b>
 <p><b>BRONZE siphon</b> Sifone Bronce \ Siphon Bronze \ Siphon Bronze \ бронза сифон</p>	SIFBR	0,93	<ul style="list-style-type: none"> <li> <b>Bronze</b></li> </ul>	<b>220,00</b>

Terre di Cielo available for washbasins and ceramic shelf | Terre di Cielo disponibles para el lavabo y la encimara de cerámica | Terre di Cielo disponibles pour le lavabo et le plan en céramique | Für Waschbecken und Keramikplatte erhältlich Terre di Cielo | Отделка Terre di Cielo доступны для раковины и керамических столешниц

-  TL - Talco
-  PM - Pomice
-  BR - Brina
-  BA - Basalto
-  LV - Lavagna
-  CM - Cemento
-  FN - Fango
-  CA - Cacao
-  AN - Arenaria
-  AV - Avena
-  LN - Lino
-  AG - Agave
-  MU - Muschio
-  PL - Polvere
-  CP - Cipria
-  CN - Canapa

Acque di Cielo available for washbasins and ceramic shelf | Acque di Cielo disponibles para el lavabo y la encimara de cerámica | Acque di Cielo disponibles pour le lavabo et le plan en céramique | Für Waschbecken und Keramikplatte erhältlich Acque di Cielo | Отделка Acque di Cielo доступны для раковины и керамических столешниц

-  OL - Oltremare
-  SM - Smeraldo
-  AL - Alga
-  CO - Corallo
-  NI - Ninfea
-  AM - Anemone

\* Terre di Cielo laquering available for cabinet | lacados Terre di Cielo disponibles para mueble | laquages Terre di Cielo disponibles pour le meuble | Für Möbel erhältliche Lackierungen Terre di Cielo | крашенная отделка Terre di Cielo доступна для ящика и столешницы

-  TL - Talco
-  PM - Pomice
-  BR - Brina
-  AN - Arenaria
-  BA - Basalto
-  MU - Muschio
-  AV - Avena
-  CM - Cemento

\* Oak finishes available for the cabinet - a smooth version and a version with the front door in solid triangular wooden strips | Essenze Rovere disponibile para el mueble en versión lisa o versión con puerta frontal con tiras de madera maciza triangulares | Essences Chêne disponibles pour le meuble en version lisse et en version avec porte frontale ornée de listels triangulaires en essence de bois massif | Holzarten Eiche für das Möbel in glatter Ausführung und in der Ausführung mit Fronttür aus dreieckigen Massivholzleisten erhältlich | Натуральные шпоны дуба доступны для тумбы с гладкой поверхностью и тумбы с передней дверцей из массива бруса треугольной формы из натурального шпона дерева











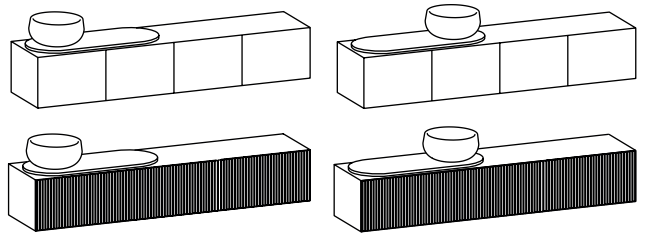



-  RS - Rovere Sbiancato
-  RN - Rovere Naturale
-  RG - Rovere Grigio
-  RO - Rovere Nero

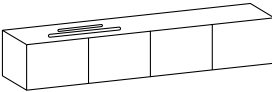

# Delfo 226

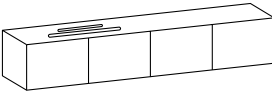
ready-made for a washbasin on the left \ preparado para lavabo a la izquierda \ pour lavabo gauche \ mit Vorbereitung für ein Waschbecken links \ мебель с ровным фасадом, раковина слева

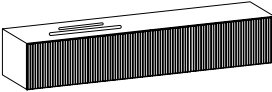
# cielo

	<b>Size (cm)</b> Medidas Dimensions Maße Размеры	<b>Product code</b> Artículo Article Artikel Артикул	<b>Net weight (kg)</b> Peso neto Poids net Reingewicht вес нетто	<b>Finishes</b> Acabados Finitions Farbe Отделки	<b>Euro</b> Евро
 <p><b>Round on top bowl</b>                      Cubela de apoio ronda                      Vasque à poser tour                      Aufsatzbecken Runde                      Раковина круглый</p>	43 x 43 x 19 h	BATO(X)*	10,30	<ul style="list-style-type: none"> <li> <b>Gloss White</b></li> <li> <b>Le Terre di Cielo</b></li> <li> <b>Le Acque di Cielo</b></li> </ul>	427,00 697,00 697,00
 <p><b>Ceramic oval countertop, reversible</b>                      Top ovalado en cerámica reversible \ Plan ovale en céramique reversibel \ Ovale Platte aus Keramik reversibel \ Овальная керамическая столешница</p> <p><b>! N.B. Tap/Faucet hole on request (mandatory position – see technical data sheet and order form).</b> \ Orificio grifo a petición (posición obligada-veáse ficha técnica y módulo de pedido) \ N.B. : Trou de robinet sur demande (position obligée – voir fiche technique et bon de commande) \ Hinweis: Hahnloch auf Anfrage (Position obligatorisch – siehe technisches Datenblatt und Bestellformular) \ P.S. Отверстие под смеситель по запросу (возможное место расположения отверстия – проверьте на технической карте изделия и модуле заказа)</p>	107 x 47 x 2h	DEPIO(X)*	17,00	<ul style="list-style-type: none"> <li> <b>Gloss White</b></li> <li> <b>Le Terre di Cielo</b></li> <li> <b>Le Acque di Cielo</b></li> </ul>	447,00 486,00 486,00  25,00
 <p><b>Lacquered cabinet ready-made for a washbasin on the left</b>                      Mueble lacado preparado para lavabo a la izquierda \ Meuble laqué pour lavabo gauche \ Möbel lackiert mit Vorbereitung für ein Waschbecken links \ Мебель крашенная с установкой раковины слева</p>	226 x 52 x 40h	DEC226SXL(X)*	91,50	<ul style="list-style-type: none"> <li> <b>Le Terre di Cielo *</b></li> </ul>	3812,00
 <p><b>Cabinet in wooden finish ready-made for a washbasin on the left</b>                      Mueble en madera preparado para lavabo a la izquierda \ Meuble bois pour lavabo gauche \ Möbel aus Holz mit Vorbereitung für ein Waschbecken links \ Тумба в деревянной отделке, раковина слева</p>	226 x 52 x 40h	DEC226SXEX(X)*	91,50	<ul style="list-style-type: none"> <li> <b>EsSENze Rovere •</b></li> <li> <b>*X = EU - Eucalipto</b></li> </ul>	4657,00 5115,00
 <p><b>Cabinet with front drawer in solid triangular wooden strips ready-made for a washbasin on the left</b>                      Mueble con frontal de cajón en listones triangulares de madera maciza en madera, preparado para un lavabo a la izquierda \ Armoire avec façade de tiroir en bandes de bois massif triangulaires en essence pour lavabo gauche \ Möbel mit Frontschublade aus dreieckigen Massivholzleisten für ein Waschbecken links \ Тумба с вертикальными планками из цельного дерева на фасаде, раковина слева</p>	226 x 52 x 40h	DECD226SXEX(X)*	89,00	<ul style="list-style-type: none"> <li> <b>EsSENze Rovere •</b></li> <li> <b>*X = EU - Eucalipto</b></li> </ul>	9702,00  10.338,00

**mandatory combination: on top Cielo washbasin + top + cabinet with holes**

**! combinación obligatoria: cubela de apoyo Cielo + encimera + mueble los agujeros \ combinación obligatoria: vasque à poser Cielo + plan + meuble con orifice \ obligatorische Kombination: Aufsatzbecken Cielo + Holzregal + Möbel mit Hahnloch \ обязательное сочетание: Накладная Cielo + столешница + Тумба с отверстием**

























**Technical symbols legend**  
*Símbolos técnicos clave / Légende symboles techniques / Technische Zeichenerklärung / Перечень технических символов*

**all sides are enamelled**  
 con todos los lados esmaltados  
 avec tous les côtés émaillés  
 alle Seiten glasiert  
 все стороны покрыты эмалью

**no tap holes**  
 sin agujero para a grifo  
 sans orifice robinet  
 ohne Hahnloch  
 без отверстия под смеситель

**without overflow**  
 sin rebosadero  
 sans trop-plein  
 ohne Überlauf  
 без слива-перелива

**on top installation**  
 instalación de apoyo  
 installation à partir du plan  
 Montage auf Platte  
 установка на столешницу

	Product code Artículo Article Artikel Артикул	Net weight (Kg) Peso neto Poids net Reingewicht вес нетто	Finishes Acabados Finitions Farbe Отделки	Euro Евро
 <p><b>Universal click/clack drain in CHROME with ceramic lid</b> Válvula universal click/clack Cromado con tapa en cerámica \ Bonde universelle clic/clac Chromé avec clapet en céramique \ Universal-Ablaufgarnitur Click-Clack Chrom mit Keramikstopfen \ Универсальный донный клапан click/clack хром с керамической крышкой</p>	PIL01(X)*	0,40	 <b>Gloss White</b>  <b>Le Terre di Cielo</b>  <b>Le Acque di Cielo</b>	<b>95,00</b> <b>139,00</b> <b>139,00</b>
 <p><b>Universal click/clack drain in BLACK MATT finish with ceramic lid</b> Válvula universal click/clack Negro Matt con tapa en cerámica \ Bonde universelle clic/clac Noir Matt avec clapet en céramique \ Universal-Ablaufgarnitur Click-Clack Matt Schwarz mit Keramikstopfen \ Универсальный донный клапан click/clack черный матовый с керамической крышкой</p>	PIL01NM(X)*	0,40	 <b>Gloss White</b>  <b>Le Terre di Cielo</b>  <b>Le Acque di Cielo</b>	<b>120,00</b> <b>169,00</b> <b>169,00</b>
 <p><b>Universal click/clack drain in CEMENTO finish with ceramic lid</b> Válvula universal click/clack Cemento con tapa en cerámica \ Bonde universelle clic/clac Cemento avec clapet en céramique \ Universal-Ablaufgarnitur Click-Clack Cement mit Keramikstopfen \ Универсальный донный Cemento click/clack с керамической крышкой</p>	PIL01CM(X)*	0,40	 <b>Gloss White</b>  <b>Le Terre di Cielo</b>  <b>Le Acque di Cielo</b>	<b>120,00</b> <b>169,00</b> <b>169,00</b>
 <p><b>Universal click/clack drain in BRONZE with ceramic lid</b> Válvula universal click/clack Bronce con tapa en cerámica \ Bonde universelle clic/clac Bronce avec clapet en céramique \ Universal-Ablaufgarnitur Click-Clack Bronze mit Keramikstopfen \ Универсальный донный клапан click/clack бронза с керамической крышкой</p>	PIL01BR(X)*	0,40	 <b>Gloss White</b>  <b>Le Terre di Cielo</b>  <b>Le Acque di Cielo</b>	<b>135,00</b> <b>182,00</b> <b>182,00</b>
 <p><b>CHROMED siphon</b> Sifone Cromado \ Siphon Chromé \ Siphon Verchromt \ сифон Chrome</p>	SISP	0,93	 <b>Chrome</b>	<b>133,00</b>
 <p><b>MATT BLACK siphon</b> Sifone Negro Mate \ Siphon Noir Mat \ Siphon Schwarz Matt \ Сифон Черный матовый</p>	SIFN	0,93	 <b>Matt Black</b>	<b>194,00</b>
 <p><b>CEMENTO siphon</b> Sifone Cemento \ Siphon Cemento \ Siphon Cemento \ сифон Cemento</p>	SIFCM	0,93	 <b>Cemento</b>	<b>194,00</b>
 <p><b>BRONZE siphon</b> Sifone Bronce \ Siphon Bronce \ Siphon Bronze \ бронза сифон</p>	SIFBR	0,93	 <b>Bronze</b>	<b>220,00</b>

Terre di Cielo available for washbasins and ceramic shelf | Terre di Cielo disponibles para el lavabo y la encimara de cerámica | Terre di Cielo disponibles pour le lavabo et le plan en céramique | Für Waschbecken und Keramikplatte erhältlich Terre di Cielo | Отделка Terre di Cielo доступны для раковины и керамических столешниц

-  TL - Talco
-  PM - Pomice
-  BR - Brina
-  BA - Basalto
-  LV - Lavagna
-  CM - Cemento
-  FN - Fango
-  CA - Cacao
-  AN - Arenaria
-  AV - Avena
-  LN - Lino
-  AG - Agave
-  MU - Muschio
-  PL - Polvere
-  CP - Cipria
-  CN - Canapa

Acque di Cielo available for washbasins and ceramic shelf | Acque di Cielo disponibles para el lavabo y la encimara de cerámica | Acque di Cielo disponibles pour le lavabo et le plan en céramique | Für Waschbecken und Keramikplatte erhältlich Acque di Cielo | Отделка Acque di Cielo доступны для раковины и керамических столешниц

-  OL - Oltremare
-  SM - Smeraldo
-  AL - Alga
-  CO - Corallo
-  NI - Ninfea
-  AM - Anemone

\* Terre di Cielo laquering available for cabinet | lacados Terre di Cielo disponibles para mueble | laquages Terre di Cielo disponibles pour le meuble | Für Möbel erhältliche Lackierungen Terre di Cielo | крашенная отделка Terre di Cielo доступна для ящика и столешницы

-  TL - Talco
-  PM - Pomice
-  BR - Brina
-  AN - Arenaria
-  BA - Basalto
-  MU - Muschio
-  AV - Avena
-  CM - Cemento



• Oak finishes available for the cabinet - a smooth version and a version with the front door in solid triangular wooden strips | Essenze Rovere disponibile para el mueble en versión lisa o versión con puerta frontal con tiras de madera maciza triangulares | Essences Chêne disponibles pour le meuble en version lisse et en version avec porte frontale ornée de listels triangulaires en essence de bois massif | Holzarten Eiche für das Möbel in glatter Ausführung und in der Ausführung mit Fronttür aus dreieckigen Massivholzleisten erhältlich | Натуральные шпоны дуба доступны для тумбы с гладкой поверхностью и тумбы с передней дверцей из массива бруса треугольной формы из натурального шпона дерева

-  RS - Rovere Sbiancato
-  RN - Rovere Naturale
-  RG - Rovere Grigio
-  RO - Rovere Nero

# Delfo 226

ready-made for two washbasins \ preparado para dos lavabos \ pour deux lavabos \ mit Vorbereitung für zwei Waschbecken \ мебель с ровным фасадом, на 2-е раковины

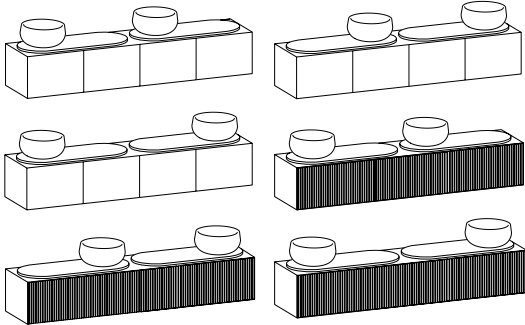
# cielo

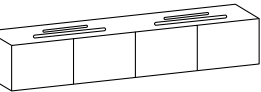
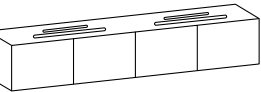
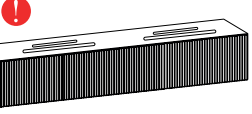
	<b>Size (cm)</b> Medidas Dimensions Maße Размеры	<b>Product code</b> Artículo Article Artikel Артикул	<b>Net weight (kg)</b> Peso neto Poids net Reingewicht вес нетто	<b>Finishes</b> Acabados Finitions Farbe Отделка	<b>Euro</b> Евро
 <p><b>Round on top bowl</b>                      Cubela de apoio ronda                      Vasque à poser tour                      Aufsatzbecken Runde                      Раковина круглый</p>	43 x 43 x 19 h	BATO(X)*	10,30	<ul style="list-style-type: none"> <li><span style="display: inline-block; width: 10px; height: 10px; background-color: white; border: 1px solid black; border-radius: 50%; margin-right: 5px;"></span> <b>Gloss White</b></li> <li><span style="display: inline-block; width: 10px; height: 10px; background-color: #8B4513; border: 1px solid black; border-radius: 50%; margin-right: 5px;"></span> <b>Le Terre di Cielo</b></li> <li><span style="display: inline-block; width: 10px; height: 10px; background-color: #008080; border: 1px solid black; border-radius: 50%; margin-right: 5px;"></span> <b>Le Acque di Cielo</b></li> </ul>	427,00 697,00 697,00
 <p><b>Ceramic oval countertop, reversible</b>                      Top ovalado en cerámica reversible \ Plan ovale en céramique réversible \ Ovale Platte aus Keramik reversibel \ Овальная керамическая столешница</p>	107 x 47 x 2h	DEPIO(X)*	17,00	<ul style="list-style-type: none"> <li><span style="display: inline-block; width: 10px; height: 10px; background-color: white; border: 1px solid black; border-radius: 50%; margin-right: 5px;"></span> <b>Gloss White</b></li> <li><span style="display: inline-block; width: 10px; height: 10px; background-color: #8B4513; border: 1px solid black; border-radius: 50%; margin-right: 5px;"></span> <b>Le Terre di Cielo</b></li> <li><span style="display: inline-block; width: 10px; height: 10px; background-color: #008080; border: 1px solid black; border-radius: 50%; margin-right: 5px;"></span> <b>Le Acque di Cielo</b></li> </ul>	447,00 486,00 486,00
<p><b>N.B. Tap/Faucet hole on request (mandatory position – see technical data sheet and order form).</b> \ Orificio grifo a petición (posición obligada-veáse ficha técnica y módulo de pedido) \ N.B. : Trou de robinet sur demande (position obligée – voir fiche technique et bon de commande) \ Hinweis: Hahnloch auf Anfrage (Position obligatorisch – siehe technisches Datenblatt und Bestellformular) \ P.S. Отверстие под смеситель по запросу (возможное место расположения отверстия – проверьте на технической карте изделия и модуле заказа)</p>					
 <p><b>Lacquered cabinet ready-made for two washbasins</b>                      Mueble lacado preparado para dos lavabos \ Meuble laqué pour deux lavabos \ Möbel lackiert mit Vorbereitung für zwei Waschbecken \ Мебель крашенная с установкой 2-х раковин</p>	226 x 52 x 40h	DEC226L(X)*	91,50	<ul style="list-style-type: none"> <li><span style="display: inline-block; width: 10px; height: 10px; background-color: #8B4513; border: 1px solid black; border-radius: 50%; margin-right: 5px;"></span> <b>Le Terre di Cielo *</b></li> </ul>	3812,00
 <p><b>Cabinet in wooden finish ready-made for two washbasins</b>                      Mueble en madera preparado para dos lavabos \ Meuble bois pour deux lavabos \ Möbel aus Holz mit Vorbereitung für zwei Waschbecken \ Тумба в деревянной отделке на 2-е раковины</p>	226 x 52 x 40h	DEC226E(X)*	91,50	<ul style="list-style-type: none"> <li><span style="display: inline-block; width: 10px; height: 10px; background-color: #A08060; border: 1px solid black; border-radius: 50%; margin-right: 5px;"></span> <b>Essenze Rovere •</b></li> <li><span style="display: inline-block; width: 10px; height: 10px; background-color: #4B3621; border: 1px solid black; border-radius: 50%; margin-right: 5px;"></span> <b>*X = EU - Eucalipto</b></li> </ul>	4657,00 5115,00
 <p><b>Cabinet with front drawer in solid triangular wooden strips ready-made for two washbasins</b>                      Mueble con frontal de cajón en listones triangulares de madera maciza en madera, preparado para dos lavabos \ Armoire avec façade de tiroir en bandes de bois massif triangulaires en essence pour deux lavabos \ Möbel mit Frontschublade aus dreieckigen Massivholzleisten für zwei Waschbecken \ Тумба с вертикальными планками из цельного дерева на фасаде, на 2-е раковины</p>	226 x 52 x 40h	DECD226E(X)*	89,00	<ul style="list-style-type: none"> <li><span style="display: inline-block; width: 10px; height: 10px; background-color: #A08060; border: 1px solid black; border-radius: 50%; margin-right: 5px;"></span> <b>Essenze Rovere •</b></li> <li><span style="display: inline-block; width: 10px; height: 10px; background-color: #4B3621; border: 1px solid black; border-radius: 50%; margin-right: 5px;"></span> <b>*X = EU - Eucalipto</b></li> </ul>	9702,00 10.338,00

**mandatory combination: on top Cielo washbasin + top + cabinet with holes**

combinación obligatoria: cubela de apoyo Cielo + encimera + mueble los agujeros \ combinación obligatoria: vasque à poser Cielo + plan + meuble con orifice \ obligatorische Kombination: Aufsatzbecken Cielo + Holzregal + Möbel mit Hahnloch \ обязательное сочетание: Накладная Cielo + столешница + Тумба с отверстиями

**Technical symbols legend**

























*Símbolos técnicos clave / Légende symboles techniques / Technische Zeichenerklärung / Перечень технических символов*

 **all sides are enamelled**  
 con todos los lados esmaltados  
 avec tous les côtés émaillés  
 alle Seiten glasiert  
 все стороны покрыты эмалью

 **no tap holes**  
 sin agujero para grifo  
 sans orifice robinet  
 ohne Hahnloch  
 без отверстия под смеситель

 **without overflow**  
 sin rebosadero  
 sans trop-plein  
 ohne Überlauf  
 без слива-перелива

 **on top installation**  
 instalación de apoyo  
 installation à partir du plan  
 Montage auf Platte  
 установка на столешницу

	Product code Artículo Article Artikel Артикул	Net weight(Kg) Peso neto Poids net Reingewicht вес нетто	Finishes Acabados Finitions Farbe Отделка	Euro Евро
 <p><b>Universal click/clack drain in CHROME with ceramic lid</b> Válvula universal click/clack Cromado con tapa en cerámica \ Bonde universelle clic/clac Chromé avec clapet en céramique \ Universal-Ablaufgarnitur Click-Clack Chrom mit Keramikstopfen \ Универсальный донный клапан click/clack хром с керамической крышкой</p>	PIL01(X)*	0,40	 <b>Gloss White</b>  <b>Le Terre di Cielo</b>  <b>Le Acque di Cielo</b>	<b>95,00</b> <b>139,00</b> <b>139,00</b>
 <p><b>Universal click/clack drain in BLACK MATT finish with ceramic lid</b> Válvula universal click/clack Negro Matt con tapa en cerámica \ Bonde universelle clic/clac Noir Matt avec clapet en céramique \ Universal-Ablaufgarnitur Click-Clack Matt Schwarz mit Keramikstopfen \ Универсальный донный клапан click/clack черный матовый с керамической крышкой</p>	PIL01NM(X)*	0,40	 <b>Gloss White</b>  <b>Le Terre di Cielo</b>  <b>Le Acque di Cielo</b>	<b>120,00</b> <b>169,00</b> <b>169,00</b>
 <p><b>Universal click/clack drain in CEMENTO finish with ceramic lid</b> Válvula universal click/clack Cemento con tapa en cerámica \ Bonde universelle clic/clac Cemento avec clapet en céramique \ Universal-Ablaufgarnitur Click-Clack Cement mit Keramikstopfen \ Универсальный донный Cemento click/clack с керамической крышкой</p>	PIL01CM(X)*	0,40	 <b>Gloss White</b>  <b>Le Terre di Cielo</b>  <b>Le Acque di Cielo</b>	<b>120,00</b> <b>169,00</b> <b>169,00</b>
 <p><b>Universal click/clack drain in BRONZE with ceramic lid</b> Válvula universal click/clack Bronce con tapa en cerámica \ Bonde universelle clic/clac Bronze avec clapet en céramique \ Universal-Ablaufgarnitur Click-Clack Bronze mit Keramikstopfen \ Универсальный донный клапан click/clack бронза с керамической крышкой</p>	PIL01BR(X)*	0,40	 <b>Gloss White</b>  <b>Le Terre di Cielo</b>  <b>Le Acque di Cielo</b>	<b>135,00</b> <b>182,00</b> <b>182,00</b>
 <p><b>CHROMED siphon</b> Sifone Cromado \ Siphon Chromé \ Siphon Verchromt \ сифон Chrome</p>	SISP	0,93	 <b>Chrome</b>	<b>133,00</b>
 <p><b>MATT BLACK siphon</b> Sifone Negro Mate \ Siphon Noir Mat \ Siphon Schwarz Matt \ Сифон Черный матовый</p>	SIFN	0,93	 <b>Matt Black</b>	<b>194,00</b>
 <p><b>CEMENTO siphon</b> Sifone Cemento \ Siphon Cemento \ Siphon Cemento \ сифон Cemento</p>	SIFCM	0,93	 <b>Cemento</b>	<b>194,00</b>
 <p><b>BRONZE siphon</b> Sifone Bronce \ Siphon Bronce \ Siphon Bronze \ бронза сифон</p>	SIFBR	0,93	 <b>Bronze</b>	<b>220,00</b>

Terre di Cielo available for washbasins and ceramic shelf | Terre di Cielo disponibles para el lavabo y la encimara de cerámica | Terre di Cielo disponibles pour le lavabo et le plan en céramique | Für Waschbecken und Keramikplatte erhältlich Terre di Cielo | Отделка Terre di Cielo доступны для раковины и керамических столешниц

-  TL - Talco
-  PM - Pomice
-  BR - Brina
-  BA - Basalto
-  LV - Lavagna
-  CM - Cemento
-  FN - Fango
-  CA - Cacao
-  AN - Arenaria
-  AV - Avena
-  LN - Lino
-  AG - Agave
-  MU - Muschio
-  PL - Polvere
-  CP - Cipria
-  CN - Canapa

Acque di Cielo available for washbasins and ceramic shelf | Acque di Cielo disponibles para el lavabo y la encimara de cerámica | Acque di Cielo disponibles pour le lavabo et le plan en céramique | Für Waschbecken und Keramikplatte erhältlich Acque di Cielo | Отделка Acque di Cielo доступны для раковины и керамических столешниц

-  OL - Oltremare
-  SM - Smeraldo
-  AL - Alga
-  CO - Corallo
-  NI - Ninfea
-  AM - Anemone

\* Terre di Cielo laquering available for cabinet | lacados Terre di Cielo disponibles para mueble | laquages Terre di Cielo disponibles pour le meuble | Für Möbel erhältliche Lackierungen Terre di Cielo | крашенная отделка Terre di Cielo доступна для ящика и столешницы

-  TL - Talco
-  PM - Pomice
-  BR - Brina
-  AN - Arenaria
-  BA - Basalto
-  MU - Muschio
-  AV - Avena
-  CM - Cemento

• Oak finishes available for the cabinet - a smooth version and a version with the front door in solid triangular wooden strips | Essenze Rovere disponibile para el mueble en versión lisa o versión con puerta frontal con tiras de madera maciza triangulares | Essences Chêne disponibles pour le meuble en version lisse et en version avec porte frontale ornée de listels triangulaires en essence de bois massif | Holzarten Eiche für das Möbel in glatter Ausführung und in der Ausführung mit Fronttür aus dreieckigen Massivholzleisten erhältlich | Натуральные шпоны дуба доступны для тумбы с гладкой поверхностью и тумбы с передней дверцей из массива бруса треугольной формы из натурального шпона дерева

-  RS - Rovere Sbiancato
-  RN - Rovere Naturale
-  RG - Rovere Grigio
-  RO - Rovere Nero

# Delfo 226

without holes

# cielo

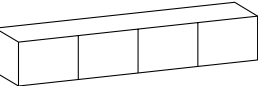
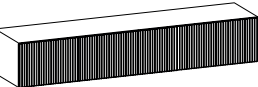
	Size (cm) Medidas Dimensions Maße Размеры	Product code Artículo Article Artikel Артикул	Net weight (kg) Peso neto Poids net Reingewicht вес нетто	Finishes Acabados Finitions Farbe Отделки	Euro Евро
 <p><b>Lacquered cabinet without holes</b> Mueble lacado sin agujero \ Meuble laqué sans orifice \ Möbel lackiert ohne Hahnloch \ Тумба крашеная без отверстия</p>	226 x 52 x 40h	DEC226LSF(X)*	91,50	● Le Terre di Cielo *	3812,00
	226 x 52 x 40h	DEC226ESF(X)*	91,50	● Essenze Rovere • ● *X = EU - Eucalipto	4657,00 5115,00
 <p><b>Cabinet with front drawer in solid triangular wooden strips without holes</b> Mueble con frontal de cajón en listones triangulares de madera maciza en madera sin agujero \ Armoire avec façade de tiroir en bandes de bois massif triangulaires en essence sans orifice \ Möbel mit Frontschublade aus dreieckigen Massivholzleisten ohne Hahnloch \ Тумба с вертикальными планками из цельного дерева на фасаде, без отверстия</p>	226 x 52 x 40h	DECD226ESF(X)*	89,00	● Essenze Rovere •	9702,00
				● *X = EU - Eucalipto	10.338,00

\* Terre di Cielo laquering available for cabinet / lacados Terre di Cielo disponibles para mueble / laquages Terre di Cielo disponibles pour le meuble / Für Möbel erhältliche Lackierungen Terre di Cielo / крашеная отделка Terre di Cielo доступна для ящика и столешницы

● TL - Talco ● PM - Pomice ● BR - Brina ● AN - Arenaria  
● BA - Basalto ● MU - Muschio ● AV - Avena ● CM - Cemento

● Oak finishes available for the cabinet - a smooth version and a version with the front door in solid triangular wooden strips / Essenze Rovere disponible para el mueble en versión lisa o versión con puerta frontal con tiras de madera maciza triangulares / Essences Chêne disponibles pour le meuble en version lisse et en version avec porte frontale ornée de listels triangulaires en essence de bois massif / Holzarten Eiche für das Möbel in glatter Ausführung und in der Ausführung mit Fronttür aus dreieckigen Massivholzleisten erhältlich / Натуральные шпоны дуба доступны для тумбы с гладкой поверхностью и тумбы с передней дверцей из массива бруса треугольной формы из натурального шпона дерева

● RS - Rovere Sbiancato ● RN - Rovere Naturale ● RG - Rovere Grigio ● RO - Rovere Nero







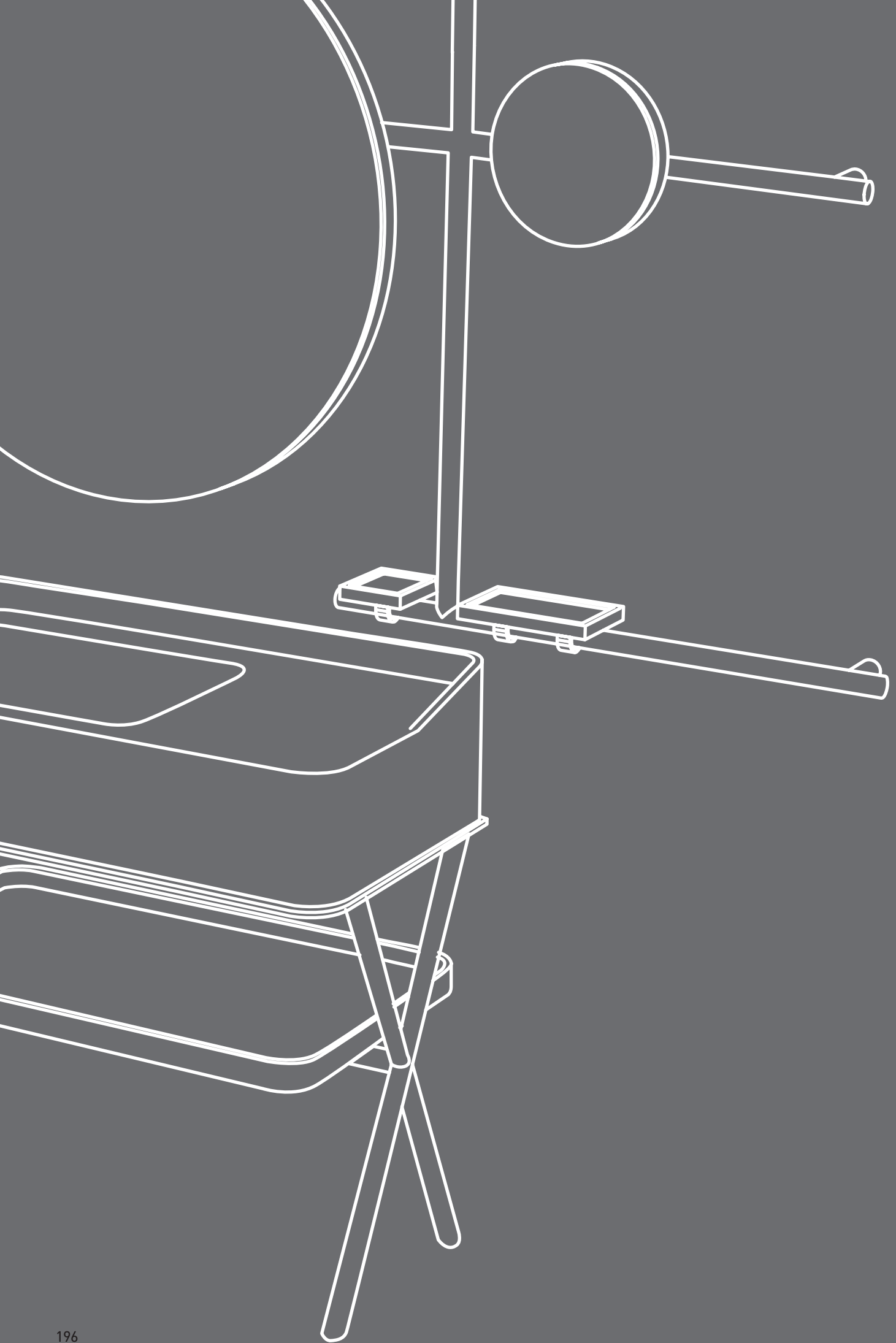

# Siwa

design **Andrea Parisio & Giuseppe Pezzano**

QR code configuratore \ configurator pg. 200

indice collezione \ collection index pg. 201

moduli d'ordine \ order form pg. 203 - 209

listino prezzi \ price list pg. 210 - 213





## Configure the product directly online and send the order to Cielo.

Configure el producto directamente online y envíe el pedido a Cielo.

Configurez le produit directement en ligne et envoyez la commande à Cielo.

Konfigurieren Sie Ihr Produkt online und schicken Sie die Bestellung direkt an Cielo.

Сконфигурируйте изделие в онлайн и перешлите заказ на фабрику Cielo.

EN

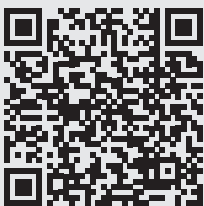

go to  
configurator

SP

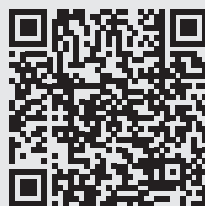

ir al  
configurador

FR



lien vers le  
configurateur

RU

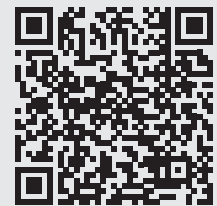

Перейдите в  
конфигуратор

## Lavabo con mobile / washbasin with cabinet

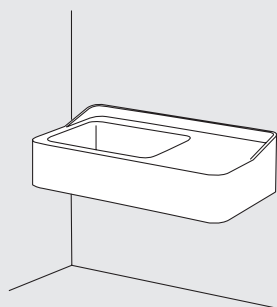

**lavabo installazione sospesa**  
washbasin, wall-hung installation  
90 x 50 x 20 h  
pag. 210

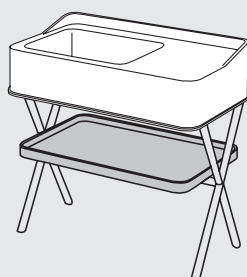

**lavabo + struttura + vassoio**  
washbasin + framework + tray  
92 x 51 x 89 h  
pag. 210

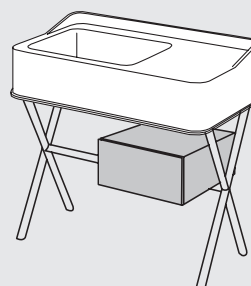

**lavabo + struttura + cassetto**  
washbasin + framework + drawer  
92 x 51 x 89 h  
pag. 210

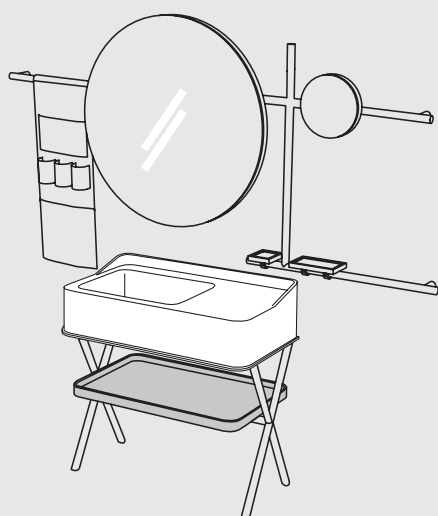

**lavabo + struttura + vassoio + composizione  
specchiera tonda** \ washbasin + framework + tray +  
round mirror composition  
92 x 51 x 89 h + 210 x 11 x 103 h  
pag. 212

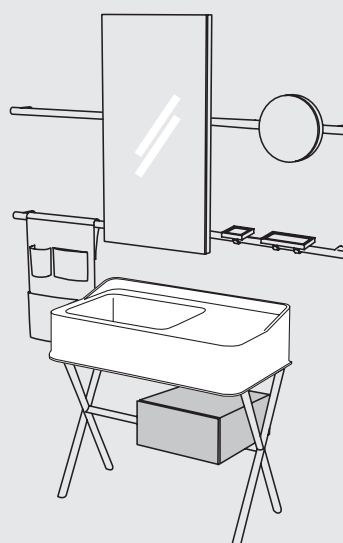

**lavabo + struttura + cassetto + composizione  
specchiera rettangolare** \ washbasin + framework +  
drawer + rectangular mirror composition  
92 x 51 x 89 h + 210 x 11 x 103 h  
pag. 213



**modelli disponibili / available models**

**SIWA**  
collection

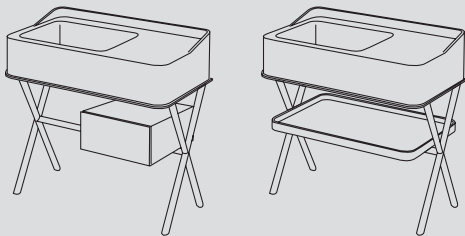

**Siwa con cassetto**  
Siwa with drawer  
92 x 51 x 89 h

**Siwa con vassoio**  
Siwa with tray  
92 x 51 x 89 h



**finiture / finishes**

**LAVABO IN CERAMICA / CERAMIC WASHBASIN**

**Le Terre di Cielo**

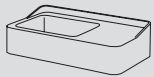

SWLA

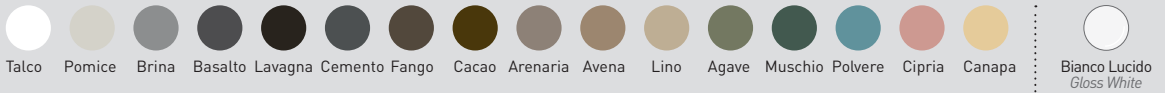

SWST

**STRUTTURA IN LEGNO / WOODEN FRAMEWORK**

**essenze / wooden finishes**

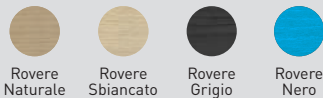

**STRUTTURA IN ACCIAIO / STEEL FRAMEWORK**

**verniciature / coatings**

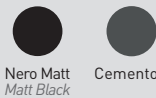

**VASSOIO E CASSETTO IN LEGNO / WOODEN TRAY AND DRAWER**

**essenze / wooden finishes**

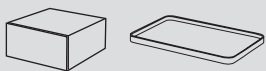

SWCL \ SWCE

SWVL \ SWVE

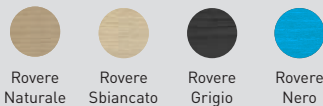

**laccature / lacquers Le Terre di Cielo**

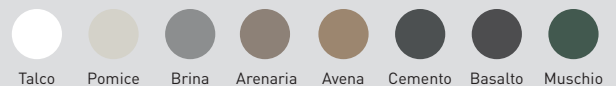

**note tecniche lavabo / washbasin technical notes**

**monoforo**  
with 1 hole

**senza foro su richiesta**  
no tap hole on request

**senza troppopieno**  
without overflow

**con un lato non smaltato**  
one side is unglazed

**installazione da appoggio su struttura**  
on top installation on framework

**installazione sospesa**  
wall-hung installation

**ATTENZIONE: obbligo struttura + lavabo + cassetto/vassoio**  
PLEASE NOTE: mandatory framework + washbasin + drawer/shelf

CLIENTE/client:  ORD. REF.:

QUANTITA'/quantity:  EMAIL:

**INDICARE CON UN SEGNO LE FINITURE SCELTE PER I DIVERSI COMPONENTI**

**INDICATE WITH A TICK, THE CHOSEN FINISHES FOR ALL THE COMPONENTS**

**art. SWVL / art. SWVE**  
**FINITURE VASSOIO IN LEGNO**  
*WOODEN TRAY FINISHES*

*laccature/laquerings*

- TL - Talco
- PM - Pomice
- BR - Brina
- AN - Arenaria
- AV - Avena
- CM - Cemento
- BA - Basalto
- MU - Muschio

*essenze legno/wood essences*

- RO - Rovere Nero
- RG - Rovere Grigio
- RS - Rovere Sbiancato
- RN - Rovere Naturale

**art. SWLA \ SWLASF**  
**FINITURE LAVABO**  
*WASHBASIN SHELF FINISHES*

Bianco/white - glossy

Le Terre di Cielo

<input type="checkbox"/> TL - Talco	<input type="checkbox"/> AN - Arenaria
<input type="checkbox"/> PM - Pomice	<input type="checkbox"/> AV - Avena
<input type="checkbox"/> BR - Brina	<input type="checkbox"/> LN - Lino
<input type="checkbox"/> BA - Basalto	<input type="checkbox"/> AG - Agave
<input type="checkbox"/> LV - Lavagna	<input type="checkbox"/> MU - Muschio
<input type="checkbox"/> CM - Cemento	<input type="checkbox"/> PL - Polvere
<input type="checkbox"/> FN - Fango	<input type="checkbox"/> CP - Cipria
<input type="checkbox"/> CA - Cacao	<input type="checkbox"/> CN - Canapa

**art. SWST**  
**FINITURE STRUTTURA IN ACCIAIO**  
*STEEL FRAMEWORK FINISHES*

*verniciature\_coatings*

- NM - Nero Matt
- CM - Cemento

**art. SWSTE**  
**FINITURE STRUTTURA IN LEGNO MASSELLO**  
*SOLID WOOD FRAMEWORK FINISHES*

*essenze legno/wood essences*

- RO - Rovere Nero
- RG - Rovere Grigio
- RS - Rovere Sbiancato
- RN - Rovere Naturale

**N.B. Il lavabo è monoforo, su richiesta può essere prodotto senza foro**

*N.B. The washbasin has 1 hole; may be made without holes upon request*

**DATA**  
DATE

**FIRMA DEL CLIENTE**  
SIGNATURE

**ATTENZIONE:**  
La rappresentazione delle finiture è puramente indicativa. Verificare le finiture con le relative cartelle.

**ATTENTION:**  
*The representation of the finishes is merely indicative. Please choose the finishes using the folders.*

Ogni oggetto possiede la peculiarità di essere elaborato secondo principi puramente tradizionali, in modo da garantirne l'assoluta originalità ed unicità. Le eventuali piccole variazioni di colore, tono o venature fra gli articoli sono da considerarsi pregi e non difetti, in quanto garanzia della fattura manuale del prodotto, che fa di ogni oggetto Cielo un pezzo unico ed esclusivo, lontano dall'omologazione industriale. In fase d'ordine si intendono, pertanto, accettate tali tolleranze che non possono dare adito a contestazioni di alcun genere.

*Every item possesses that particular feature of being processed according to purely traditional principles that guarantee its absolute originality and uniqueness. The small variations in colour, hues or streaks on the items are to be considered as qualities and not defects, since they warranty the handcrafted processing which makes each Cielo item a unique and exclusive piece that cannot be compared to industrial standardization. When making the order, the client implicitly accepts those various features that may give rise to claims of any sort.*

Verificare sempre le disponibilità e i tempi di consegna con il commerciale.

*Always check the availability and delivery time with the commercial department.*





# Modulo Ordine Siwa con cassetto

Siwa with drawer Order Form

# cielo

CLIENTE/client:  ORD. REF.:

QUANTITA'/quantity:  EMAIL:

INDICARE CON UN SEGNO LE FINITURE SCELTE PER I DIVERSI COMPONENTI

INDICATE WITH A TICK, THE CHOSEN FINISHES FOR ALL THE COMPONENTS

**art. SWLA \ SWLASF**  
**FINITURE LAVABO**  
WASHBASIN SHELF FINISHES

Bianco/white - glossy

Le Terre di Cielo

<input type="checkbox"/> TL - Talco	<input type="checkbox"/> AN - Arenaria
<input type="checkbox"/> PM - Pomice	<input type="checkbox"/> AV - Avena
<input type="checkbox"/> BR - Brina	<input type="checkbox"/> LN - Lino
<input type="checkbox"/> BA - Basalto	<input type="checkbox"/> AG - Agave
<input type="checkbox"/> LV - Lavagna	<input type="checkbox"/> MU - Muschio
<input type="checkbox"/> CM - Cemento	<input type="checkbox"/> PL - Polvere
<input type="checkbox"/> FN - Fango	<input type="checkbox"/> CP - Cipria
<input type="checkbox"/> CA - Cacao	<input type="checkbox"/> CN - Canapa

**art. SWST**  
**FINITURE STRUTTURA IN ACCIAIO**  
STEEL FRAMEWORK FINISHES

verniciature\_coatings

- NM - Nero Matt
- CM - Cemento

**art. SWSTE**  
**FINITURE STRUTTURA IN LEGNO MASSELLO**  
SOLID WOOD FRAMEWORK FINISHES

essenze legno/wood essences

- RO - Rovere Nero
- RG - Rovere Grigio
- RS - Rovere Sbiancato
- RN - Rovere Naturale

**art. SWCL / art. SWCE**  
**FINITURE CASSETTO IN LEGNO**  
WOODEN DRAWER FINISHES

laccature/laquerings

- TL - Talco
- PM - Pomice
- BR - Brina
- AN - Arenaria
- AV - Avena
- CM - Cemento
- BA - Basalto
- MU - Muschio

essenze legno/wood essences

- RO - Rovere Nero
- RG - Rovere Grigio
- RS - Rovere Sbiancato
- RN - Rovere Naturale

**N.B. Il lavabo è monoforo, su richiesta può essere prodotto senza foro**

*N.B. The washbasin has 1 hole; may be made without holes upon request*

DATA  
DATE

FIRMA DEL CLIENTE  
SIGNATURE

ATTENZIONE:  
La rappresentazione delle finiture è puramente indicativa. Verificare le finiture con le relative cartelle.

Ogni oggetto possiede la peculiarità di essere elaborato secondo principi puramente tradizionali, in modo da garantirne l'assoluta originalità ed unicità. Le eventuali piccole variazioni di colore, tono o venature fra gli articoli sono da considerarsi pregi e non difetti, in quanto garanzia della fattura manuale del prodotto, che fa di ogni oggetto Cielo un pezzo unico ed esclusivo, lontano dall'omologazione industriale. In fase d'ordine si intendono, pertanto, accettate tali tolleranze che non possono dare adito a contestazioni di alcun genere.

Verificare sempre le disponibilità e i tempi di consegna con il commerciale.

ATTENTION:  
The representation of the finishes is merely indicative. Please choose the finishes using the folders.

Every item possesses that particular feature of being processed according to purely traditional principles that guarantee its absolute originality and uniqueness. The small variations in colour, hues or streaks on the items are to be considered as qualities and not defects, since they warranty the handcrafted processing which makes each Cielo item a unique and exclusive piece that cannot be compared to industrial standardization. When making the order, the client implicitly accepts those various features that may give rise to claims of any sort.

Always check the availability and delivery time with the commercial department.

specchi disponibili / available mirrors

**SIWA**  
collection

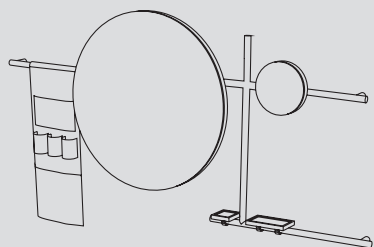

**Siwa specchiera tonda**  
Siwa round mirror  
210 x 11 x 103 h



finiture / finishes

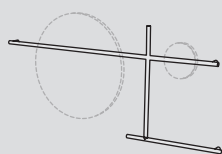

SWSTT \ SWSTE

**STRUTTURA IN LEGNO**  
WOODEN FRAMEWORK

essenze / wooden finishes

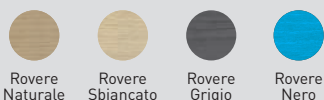

Rovere Naturate   Rovere Sbiancato   Rovere Grigio   Rovere Nero

**STRUTTURA IN METALLO**  
METAL BAR

verniciature / coatings

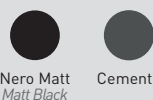

Nero Matt  
Matt Black   Cemento

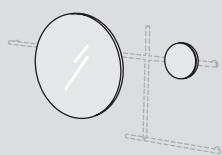

SWSPT \ SWSPI

**CORNICE SPECCHIO IN LEGNO /**  
MIRROR WOODEN FRAMEWORK

laccature / lacquers



Nero Matt  
Matt Black   Cemento



SWSCT

**SACCHE IN CUOIO**  
LEATHER STORAGE BAGS

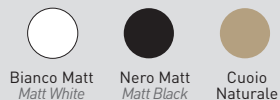

Bianco Matt  
Matt White   Nero Matt  
Matt Black   Cuoio  
Naturale

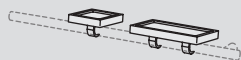

SWM10 \ SWM20

**MENSOLE IN LIVINGTEC**  
SHELVES IN LIVINGTEC



Bianco Matt  
Matt White



**composizione obbligatoria: struttura + specchio + mensole**  
Mandatory composition: bar for mirror + mirror + shelves

# Modulo Ordine Specchiera Siwa Tonda

Siwa Round Mirror Order Form

# cielo

CLIENTE/client:  ORD. REF.:

QUANTITA'/quantity:  EMAIL:

INDICARE CON UN SEGNO LE FINITURE SCELTE PER I DIVERSI COMPONENTI

INDICATE WITH A TICK, THE CHOSEN FINISHES FOR ALL THE COMPONENTS

**art. SWSPT**  
**FINITURE CORNICE SPECCHIO IN LEGNO**  
MIRROR WOODEN FRAMEWORK FINISHES  
laccature/laquerings  
● NM - Nero Matt  
● CM - Cemento

**art. SWSPI - specchio ingranditore \ magnifying mirror**  
**FINITURE CORNICE SPECCHIO IN LEGNO**  
MIRROR WOODEN FRAMEWORK FINISHES  
laccature/laquerings  
● NM - Nero Matt  
● CM - Cemento

**art. SWSCT**  
**FINITURE SACCA IN CUOIO**  
LEATHER STORAGE BAG FINISHES  
● BI - Bianco/White  
● NA - Cuoio naturale/leather  
● NE - Nero/Black

**art. SWM10 / art. SWM20**  
**FINITURE MENSOLE IN LIVINGTEC**  
SHELVES IN LIVINGTEC  
● Bianco Matt/Matt White

**art. SWSTT**  
**FINITURE STRUTTURA IN METALLO**  
METAL BAR FINISHES  
verniciature\_coatings  
● NM - Nero Matt  
● CM - Cemento

**art. SWSTTE**  
**FINITURE STRUTTURA IN LEGNO MASSELLO**  
SOLID WOOD BAR FINISHES  
essenze legno/wood essences  
● RO - Rovere Nero  
● RG - Rovere Grigio  
● RS - Rovere Sbiancato  
● RN - Rovere Naturale

DATA  
DATE

FIRMA DEL CLIENTE  
SIGNATURE

ATTENZIONE:  
La rappresentazione delle finiture è puramente indicativa. Verificare le finiture con le relative cartelle.

Ogni oggetto possiede la peculiarità di essere elaborato secondo principi puramente tradizionali, in modo da garantirne l'assoluta originalità ed unicità. Le eventuali piccole variazioni di colore, tono o venature fra gli articoli sono da considerarsi pregi e non difetti, in quanto garanzia della fattura manuale del prodotto, che fa di ogni oggetto Cielo un pezzo unico ed esclusivo, lontano dall'omologazione industriale. In fase d'ordine si intendono, pertanto, accettate tali tolleranze che non possono dare adito a contestazioni di alcun genere.

Verificare sempre le disponibilità e i tempi di consegna con il commerciale.

ATTENTION:  
The representation of the finishes is merely indicative. Please choose the finishes using the folders.

Every item possesses that particular feature of being processed according to purely traditional principles that guarantee its absolute originality and uniqueness. The small variations in colour, hues or streaks on the items are to be considered as qualities and not defects, since they warranty the handcrafted processing which makes each Cielo item a unique and exclusive piece that cannot be compared to industrial standardization. When making the order, the client implicitly accepts those various features that may give rise to claims of any sort.

Always check the availability and delivery time with the commercial department.





**specchi disponibili / available mirrors**

**SIWA**  
collection

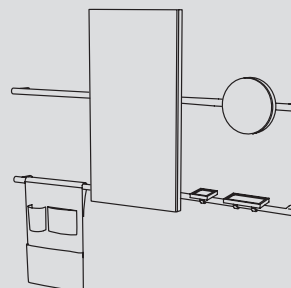

**Siwa specchiera rettangolare**  
Siwa rectangular mirror  
163 x 11 x 94 h

**finiture / finishes**

**STRUTTURA IN LEGNO**  
WOODEN FRAMEWORK

essenze / wooden finishes

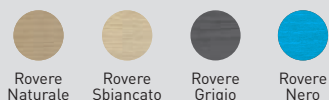

Rovere Naturale    Rovere Sbiancato    Rovere Grigio    Rovere Nero

**STRUTTURA IN METALLO**  
METAL BAR

verniciature / coatings

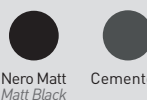

Nero Matt  
Matt Black    Cemento

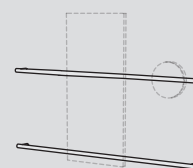

SWSTR \ SWSTRE

**CORNICE SPECCHIO IN LEGNO /**  
MIRROR WOODEN FRAMEWORK

laccature / lacquers

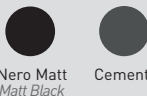

Nero Matt  
Matt Black    Cemento

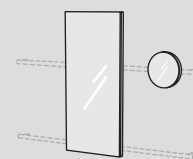

SWSPR \ SWSPRI

**SACCHE IN CUOIO**  
LEATHER STORAGE BAGS



Cuoio Naturale    Nero Matt  
Matt Black    Bianco Matt  
Matt White



SWSCR



**composizione obbligatoria: struttura + specchio + mensole**  
Mandatory composition: bar for mirror + mirror + shelves

**MENSOLE IN LIVINGTEC**  
SHELVES IN LIVINGTEC



Bianco Matt  
Matt White

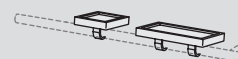

SWM10 \ SWM20

# Modulo Ordine Specchiera Siwa Rettangolare

Siwa Rectangular Mirror Order Form

# cielo

CLIENTE/client:  ORD. REF.:

QUANTITA'/quantity:  EMAIL:

INDICARE CON UN SEGNO LE FINITURE SCELTE PER I DIVERSI COMPONENTI

INDICATE WITH A TICK, THE CHOSEN FINISHES FOR ALL THE COMPONENTS

art. **SWSPR**

**FINITURE CORNICE SPECCHIO IN LEGNO**

MIRROR WOODEN FRAMEWORK FINISHES

laccature/laquerings

**NM - Nero Matt**

**CM - Cemento**

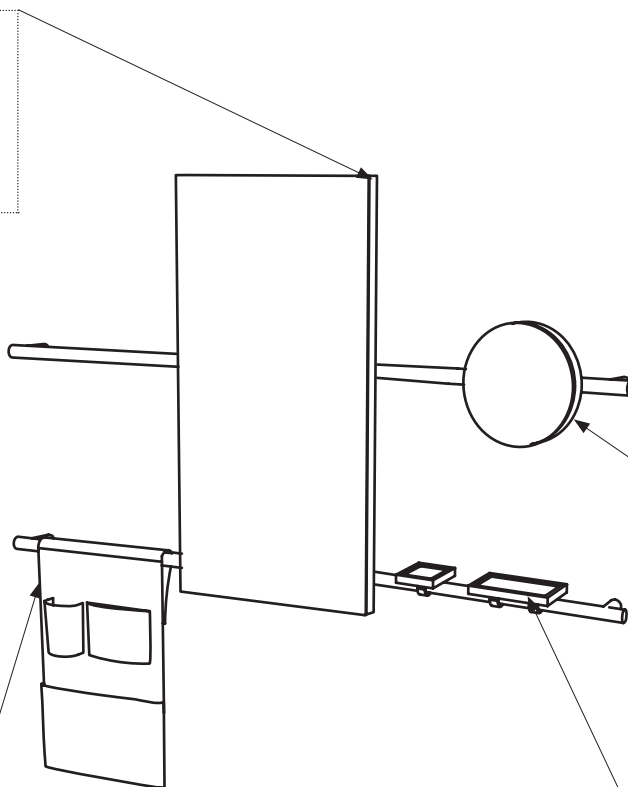

art. **SWSPI** - specchio ingranditore \ magnifying mirror

**FINITURE CORNICE SPECCHIO IN LEGNO**

MIRROR WOODEN FRAMEWORK FINISHES

laccature/laquerings

**NM - Nero Matt**

**CM - Cemento**

art. **SWSTR**

**FINITURE STRUTTURA IN METALLO**

METAL BAR FINISHES

verniciature\_coatings

**NM - Nero Matt**

**CM - Cemento**

art. **SWSCR**

**FINITURE SACCA IN CUOIO**

LEATHER STORAGE BAG FINISHES

**BI - Bianco/White**

**NA - Cuoio naturale/leather**

**NE - Nero/Black**

art. **SWM10 / art. SWM20**

**FINITURE MENSOLE IN LIVINGTEC**

SHELVES IN LIVINGTEC

**Bianco Matt/Matt White**

art. **SWSTRE**

**FINITURE STRUTTURA IN LEGNO MASSELLO**

SOLID WOOD BAR FINISHES

essenze legno/wood essences

**RO - Rovere Nero**

**RG - Rovere Grigio**

**RS - Rovere Sbiancato**

**RN - Rovere Naturale**

**DATA**

DATE

**FIRMA DEL CLIENTE**

SIGNATURE

ATTENZIONE:

La rappresentazione delle finiture è puramente indicativa. Verificare le finiture con le relative cartelle.

Ogni oggetto possiede la peculiarità di essere elaborato secondo principi puramente tradizionali, in modo da garantirne l'assoluta originalità ed unicità. Le eventuali piccole variazioni di colore, tono o venature fra gli articoli sono da considerarsi pregi e non difetti, in quanto garanzia della fattura manuale del prodotto, che fa di ogni oggetto Cielo un pezzo unico ed esclusivo, lontano dall'omologazione industriale. In fase d'ordine si intendono, pertanto, accettate tali tolleranze che non possono dare adito a contestazioni di alcun genere.











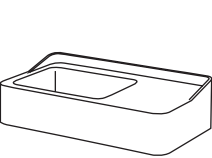





Verificare sempre le disponibilità e i tempi di consegna con il commerciale.

ATTENTION:





















The representation of the finishes is merely indicative. Please choose the finishes using the folders.

Every item possesses that particular feature of being processed according to purely traditional principles that guarantee its absolute originality and uniqueness. The small variations in colour, hues or streaks on the items are to be considered as qualities and not defects, since they warranty the handcrafted processing which makes each Cielo item a unique and exclusive piece that cannot be compared to industrial standardization. When making the order, the client implicitly accepts those various features that may give rise to claims of any sort.

Always check the availability and delivery time with the commercial department.

	<b>Size (cm)</b> Medidas Dimensions Maße Размеры	<b>Product code</b> Artículo Article Artikel Артикул	<b>Net weight (Kg)</b> Peso neto Poids net Reingewicht вес нетто	<b>Finishes</b> Acabados Finitions Farbe Отделка	<b>Euro</b> Евро
	92 x 51 x h 89				
	 <p><b>Ceramic washbasin with 1 hole</b>            Lavabo de cerámica monoagujero            Lavabo en céramique avec un trou            Waschbecken aus Keramik mit 1 Hahnloch            Керамическая раковина на одно отверстие</p>	SWLA(X)* SWLASF(X)* <b>no tap hole</b> sin agujero - sans orifice - ohne Loch без отверстия	32,00	 <b>Gloss White</b> <hr/>  <b>Le Terre di Cielo</b>	829,00 <hr/> 1120,00
	<p><b>Steel framework for washbasin</b>            Estructura para lavabo en acero            Structure en acier pour lavabo            Gestell für Waschbecken aus Stahl            Структура под раковину стальная</p>	SWST(X)*	7,50	 *X = <b>NM- Matt Black</b> <hr/>  *X = <b>CM - Cemento</b>	832,00 <hr/> 832,00
	<p><b>Wooden framework for washbasin - solid wood</b>            Estructura para lavabo en MADERA MACIZA            Structure en bois massif            Gestell für Waschbecken aus MASSIVHOLZ            Структура под раковину из массива дерева</p>	SWSTE(X)*	5,50	 <b>EsSENze ROvere *</b>	1523,00
	<p><b>Lacquered tray</b>            Bandeja lacada \ Plateau laqué            Tablett lackiert \ Полочка крашенная</p>	SWVL(X)*	4,00	 <b>Le Terre di Cielo •</b>	357,00
	<p><b>Tray in wooden finish</b>            Bandeja de madera \ Plateau en essence de bois \ Tablett aus Holz \ Полочка деревянная</p>	SWVE(X)*	4,00	 <b>EsSENze ROvere *</b>	607,00
	<p><b>Lacquered drawer</b>            Cajón lacado \ Tiroir laqué            Schubfach lackiert \ Крашенный ящик</p>	SWCL(X)*	10,00	 <b>Le Terre di Cielo •</b>	590,00
	<p><b>Drawer in wooden finish</b>            Cajón de madera \ Tiroir en bois            Holzschubfach \ Ящик с отделкой натуральным шпоном</p>	SWCE(X)*	10,00	 <b>EsSENze ROvere *</b>	803,00

**!** PLEASE NOTE: mandatory framework + washbasin + drawer/shelf  
 obligatorio estructura + lavabo + cajón/encimera  
 obligatoire structure + vasque + tiroir/plan  
 obligatorisch Struktur + Waschbecken + Schublade/Holzregal  
 обязательно конструкция + умывальник + выдвижной ящик / столешница

	Product code Artículo Article Artikel Артикул	Net weight <sub>(kg)</sub> Peso neto Poids net Reingewicht вес нетто	Finishes Acabados Finitions Farbe Отделки	Euro Евро
 <p><b>Universal click/clack drain in CHROME with ceramic lid</b> Válvula universal click/clack Cromado con tapa en cerámica Bonde universelle clic/clac Chromé avec clapet en céramique Universal-Ablaufgarnitur Click-Clack Chrom mit Keramikstopfen Универсальный донный клапан click/clack хром с керамической крышкой</p>	PIL01(X)*	0,40	 <b>Gloss White</b>	<b>95,00</b>
			 <b>Le Terre di Cielo</b>	<b>139,00</b>
 <p><b>Universal click/clack drain in BLACK MATT finish with ceramic lid</b> Válvula universal click/clack Negro Matt con tapa en cerámica Bonde universelle clic/clac Noir Mat avec clapet en céramique Universal-Ablaufgarnitur Click-Clack Matt Schwarz mit Keramikstopfen Универсальный донный клапан click/clack черный матовый с керамической крышкой</p>	PIL01NM(X)*	0,40	 <b>Gloss White</b>	<b>120,00</b>
			 <b>Le Terre di Cielo</b>	<b>169,00</b>
 <p><b>Universal click/clack drain in CEMENTO finish with ceramic lid</b> Válvula universal click/clack Cemento con tapa en cerámica Bonde universelle clic/clac Cemento avec clapet en céramique Universal-Ablaufgarnitur Click-Clack Cement mit Keramikstopfen Универсальный донный Cemento click/clack с керамической крышкой</p>	PIL01CM(X)*	0,40	 <b>Gloss White</b>	<b>120,00</b>
			 <b>Le Terre di Cielo</b>	<b>169,00</b>
 <p><b>Universal click/clack drain in BRONZE with ceramic lid</b> Válvula universal click/clack Bronce con tapa en cerámica Bonde universelle clic/clac Bronze avec clapet en céramique Universal-Ablaufgarnitur Click-Clack Bronze mit Keramikstopfen Универсальный донный клапан click/clack бронза с керамической крышкой</p>	PIL01BR(X)*	0,40	 <b>Gloss White</b>	<b>135,00</b>
			 <b>Le Terre di Cielo</b>	<b>182,00</b>
 <p><b>CHROMED siphon</b> Sifone Cromado \ Siphon Chromé \ Siphon Verchromt \ сифон Chrome</p>	SISP	0,93	 <b>Chrome</b>	<b>133,00</b>
 <p><b>MATT BLACK siphon</b> Sifone Negro Mate \ Siphon Noir Mat \ Siphon Schwarz Matt \ Сифон Черный матовый</p>	SIFN	0,93	 <b>Matt Black</b>	<b>194,00</b>
 <p><b>CEMENTO siphon</b> Sifone Cemento \ Siphon Cemento \ Siphon Cemento \ сифон Cemento</p>	SIFCM	0,93	 <b>Cemento</b>	<b>194,00</b>
 <p><b>BRONZE siphon</b> Sifone Bronce \ Siphon Bronze \ Siphon Bronze \ бронза сифон</p>	SIFBR	0,93	 <b>Bronze</b>	<b>220,00</b>

**Terre di Cielo available for ceramic washbasins**

*Terre di Cielo disponibles para el lavabo de cerámica | Terre di Cielo disponibles pour le lavabo en céramique | Für Waschbecken erhältliche Terre di Cielo | Отделка Terre di Cielo доступны для раковины*

**\* Terre di Cielo laquering available for tray and drawer**

*Lacados de Terre di Cielo disponible para bandejas y cajoneras | Couleur Terre di Cielo disponible pour le plateau et toitr en laquage | Für das Tablett und die Schublade erhältliche Lackierungen Terre di Cielo | Цвета Terre di Cielo доступны для полочки и ящиков*

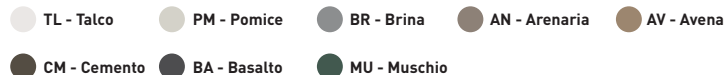
**\* Essenze Rovere****Technical symbols legend** / Símbolos técnicos / clé / Légende symboles techniques / Technische Zeichenerklärung / Перечень технических символов

 <p><b>with 1 hole</b> con 1 agujero avec un trou mit 1-Loch одно отверстие</p>	 <p><b>no tap hole on request</b> sin agujero, solo a petición sans orifice sur demande auf Anfrage ohne Loch без отверстия под смеситель по запросу</p>	 <p><b>without overflow</b> sin rebosadero sans trop-plein ohne Überlauf без слива-перелива</p>	 <p><b>one side is unglazed</b> con un lado sin esmaltar avec un côté non émaillé eine Seite unglasiert одна сторона не покрыта эмалью</p>	 <p><b>on top installation on framework</b> instalación de apoyo installation à partir du plan Montage auf Platte установка на столешницу</p>	 <p><b>wall-hung installation</b> instalación suspendida installation suspendue wandhängende Montage подвесная установка</p>	 <p><b>with fixing parts</b> fijaciones incluidas inklusive Befestigungen в комплекте с крепежами</p>
---	---	--	---	--	---	--

# Siwa \ Round mirror composition

Composición de espejo redondo \ composition avec miroir rond \ Komposition mit rundem Spiegel \ Композиция с круглым зеркалом

# cielo

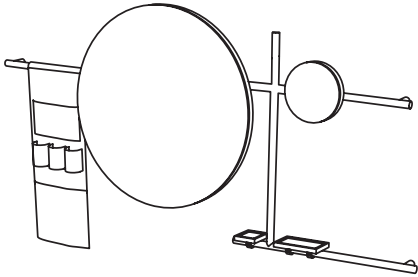
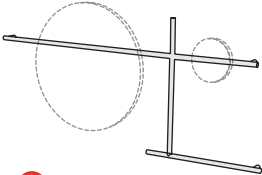
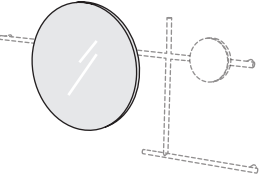
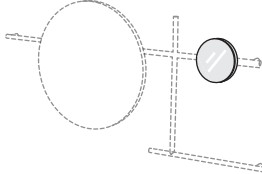
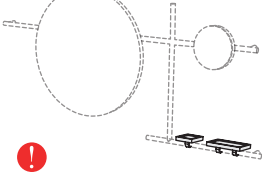
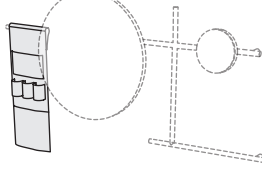
	<b>Size (cm)</b> Medidas Dimensions Maße Размеры	<b>Product code</b> Artículo Article Artikel Артикул	<b>Net weight(kg)</b> Peso neto Poids net Reingewicht вес нетто	<b>Finishes</b> Acabados Finitions Farbe Отделки	<b>Euro</b> Евро
 <p><b>Metal bar for mirror</b>                      Estructura para espejo en metal \ Structure métal pour miroir \ Gestell für Spiegel aus Metall \ Структура для зеркала из металла</p> <p><b>Wooden bar for mirror - SOLID WOOD</b>                      Estructura para espejo en MADERA MACIZA \ structure en bois massif pour miroir \ Gestell für Spiegel aus MASSIVHOLZ \ Структура для зеркала из массива дерева</p>	210 x 10 x 103 h       210 x 6,5 x 94 h	SWSTT(X)*       SWSTTE(X)*	5,00       3,50	● *X = <b>NM - Matt Black</b>  ● *X = <b>CM - Cemento</b>  ● <b>Essenze Rovere*</b>	750,00       1353,00
 <p><b>Round mirror</b>                      Espejo redondo \ Miroir rond \ Runder Spiegel \ Зеркало круглое</p>	0 90 x 2,5	SWSPT(X)*	16,00	● *X = <b>NM - Matt Black</b>  ● *X = <b>CM - Cemento</b>	879,00  879,00
 <p><b>Magnifying mirror</b>                      Espejo de aumento \ miroir agrandissant \ Vergrößerungsspiegel \ Зеркало увеличительное</p>	0 25 x 1,5	SWSPI(X)*	0,50	● *X = <b>NM - Matt Black</b>  ● *X = <b>CM - Cemento</b>	203,00  203,00
 <p><b>Shelves in LivingTec</b>                      Encimera en LivingTec \ étagères en Livingtec \ Konsolen aus LivingTec \ Полочка из материала LivingTec</p>	10 x 9 x 1,5 h   20 x 9 x 1,5 h	SWM10   SWM20	0,15   0,29	○ <b>Matt White</b>  ○ <b>Matt White</b>	76,00  98,00
 <p><b>Leather storage bag</b>                      Saco portaobjetos en cuero \ Sacoche en cuir \ Hängeorganzier aus Leder \ Органайзер из натуральной кожи</p>	32 x 91 h	SWSCT	1,30	○ *X = <b>BI - White</b> ● *X = <b>NA - Leather</b> ● *X = <b>NE - Black</b>	590,00 590,00 590,00

**Mandatory composition: bar for mirror + mirror + shelves**

combinaison obligatoire: structure + espejo + encimera  
 Combinación obligatoria: structure + miroir + étagères  
 obligatorische Kombination: Gestell + Spiegel + Konsolen  
 обязательное сочетание: Структура + Зеркало + Полочка

\* **Essenze Rovere**

- RS - Rovere Sbiancato
- RN - Rovere Naturale
- RG - Rovere Grigio
- RO - Rovere Nero

# Siwa \ Rectangular mirror composition

Composición de espejo rectangular \ composition avec miroir rectangulaire \ Komposition mit Rechteckiger Spiegel \ Композиция с Зеркало  
прямоугольное

# cielo

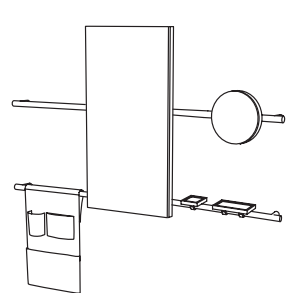
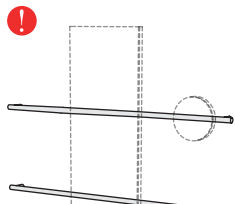
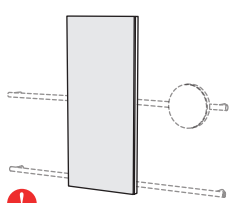
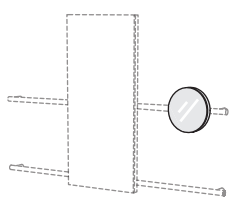
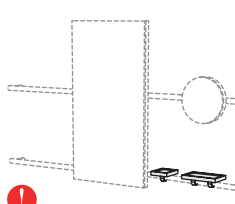
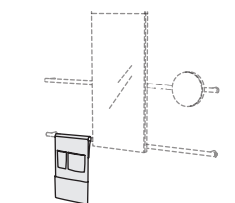
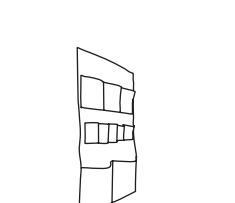
	<b>Size (cm)</b> Medidas Dimensions Maße Размеры	<b>Product code</b> Artículo Article Artikel Артикул	<b>Net weight (Kg)</b> Peso neto Poids net Reingewicht вес нетто	<b>Finishes</b> Acabados Finitions Farbe Отделки	<b>Euro</b> Евро
 <p><b>Metal bar for mirror</b>                      Estructura para espejo en metal \ Structure métal pour miroir \ Gestell für Spiegel aus Metall \ Структура для зеркала из металла</p> <p><b>Wooden bar for mirror - SOLID WOOD</b>                      Estructura para espejo en MADERA MACIZA \ structure en bois massif pour miroir \ Gestell für Spiegel aus MASSIVHOLZ \ Структура для зеркала из массива дерева</p>	154 x 6,5 x 50 h	SWSTR(X)*	3,50	● *X = NM - Matt Black ● *X = CM - Cemento	537,00 537,00
 <p><b>Rectangular mirror</b>                      Espejo rectangular \ Miroir rectangulaire \ Rechteckiger Spiegel \ Зеркало прямоугольное</p>	45 x 2,5 x 110 h	SWSPR(X)*	13,00	● *X = NM - Matt Black ● *X = CM - Cemento	645,00 645,00
 <p><b>Magnifying mirror</b>                      Espejo de aumento \ miroir agrandissant \ Vergrößerungsspiegel \ Зеркало увеличительное</p>	Ø 25 x 1,5	SWSPI(X)*	0,50	● *X = NM - Matt Black ● *X = CM - Cemento	203,00 203,00
 <p><b>Shelves in LivingTec</b>                      Encimera en LivingTec \ étagères en Living tec \ Konsolen aus LivingTec \ Полочка из материала LivingTec</p>	10 x 9 x 1,5 20 x 9 x 1,5	SWM10 SWM20	0,15 0,29	○ Matt White ○ Matt White	76,00 98,00
 <p><b>Leather storage bag</b>                      Saco portaobjetos en cuero \ Sacoche en cuir \ Hängeorganzier aus Leder \ Органайзер из натуральной кожи</p>	32 x 50 h	SWSCR	0,80	○ *X = BI - White ● *X = NA - Leather ● *X = NE - Black	345,00 345,00 345,00
 <p><b>Wall-hung leather storage bag</b>                      Saco portaobjetos a pared \ accessoire de rangement mural \ Hängeorganzier in Wandausführung \ Органайзер настенный</p>	64 x 90 h	SWSCP	2,00	○ *X = BI - White ● *X = NA - Leather ● *X = NE - Black	806,00 806,00 806,00



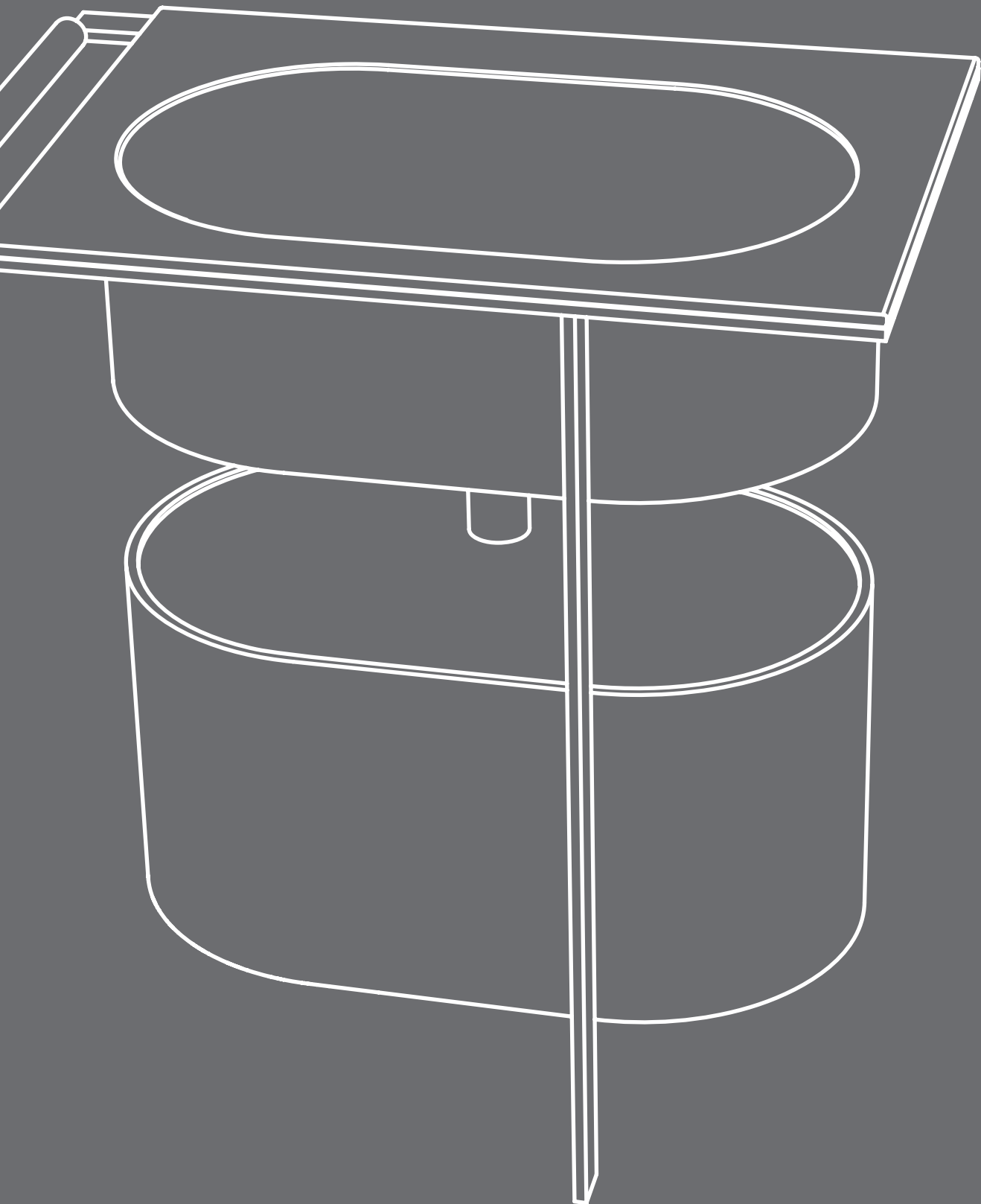

# Kyros

design **Andrea Parisio & Giuseppe Pezzano**

QR code configuratore \ configurator pg. 218

indice collezione \ collection index pg. 219

moduli d'ordine \ order form pg. 221

listino prezzi \ price list pg. 222 - 223





## Configure the product directly online and send the order to Cielo.

Configure el producto directamente online y envíe el pedido a Cielo.  
 Configurez le produit directement en ligne et envoyez la commande à Cielo.  
 Konfigurieren Sie Ihr Produkt online und schicken Sie die Bestellung direkt an Cielo.  
 Сконфигурируйте изделие в онлайн и перешлите заказ на фабрику Cielo.

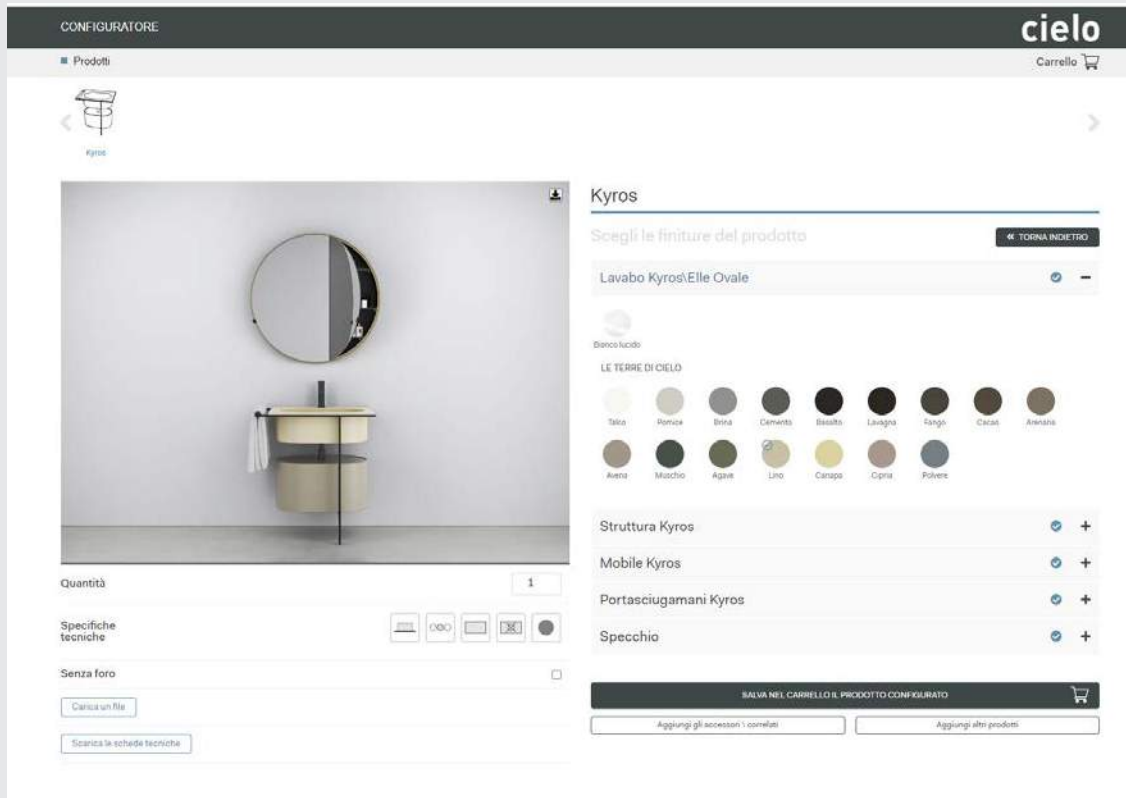

EN

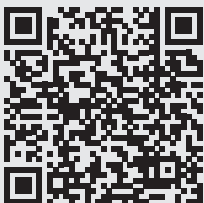

go to  
configurator

SP

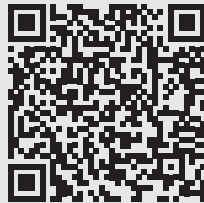

ir al  
configurador

FR

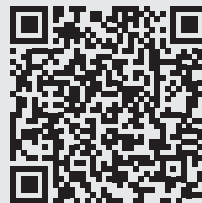

lien vers le  
configurateur

RU

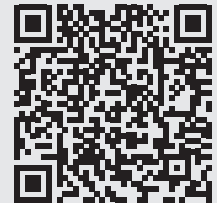

Перейдите в  
конфигуратор

## Lavabo con mobile / washbasin with cabinet

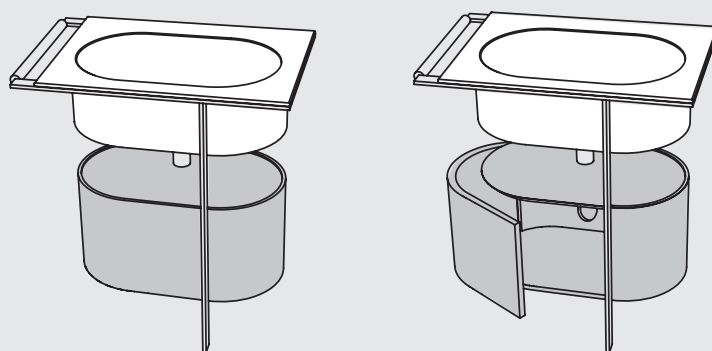

**lavabo + struttura + mobile + portasciugamani**

washbasin + framework + cabinet + towel rail

78,5 x 50 x 85 h

pag. 222



modelli disponibili / available models

**KYROS**

collection

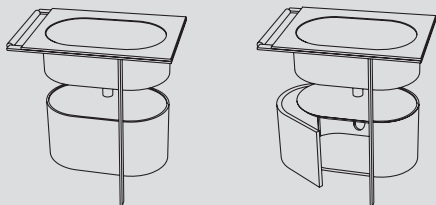

**Kyros con mobile e portasciugamani**  
Kyros with cabinet and towel rail



finiture / finishes

**LAVABO IN CERAMICA / CERAMIC WASHBASIN**

**Le Terre di Cielo**



EKLAO

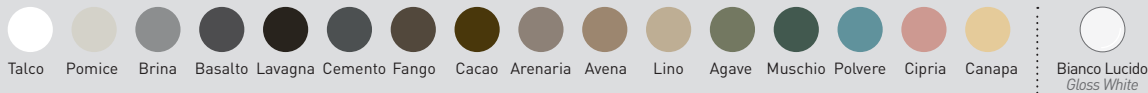

**MOBILE IN LEGNO / WOODEN CABINET**

**laccature / lacquers Le Terre di Cielo**

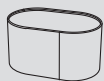

KYCL \ KYCE

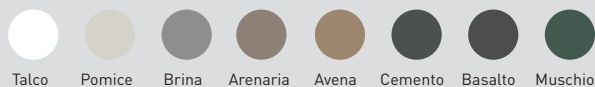

**essenze / wooden finishes**

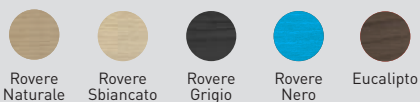

**STRUTTURA IN ACCIAIO / STEEL FRAMEWORK**

**verniciature / coatings**



KYST



KYPL

**PORTASCIUGAMANI IN LEGNO / WOODEN TOWEL RAIL**

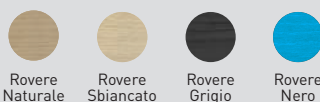

note tecniche lavabo / washbasin technical notes

 **monoforo predisposto 3 fori**  
with 1 hole prepared 3 holes

 **senza foro su richiesta**  
no tap hole on request

 **senza troppopieno**  
without overflow

 **con tutti i lati smaltati**  
all enamelled sides

 **composizione obbligatoria: lavabo + struttura + mobile + portasciugamani**  
Mandatory combination: washbasin + cabinet + framework + towel rail

# Modulo Ordine Kyros

Kyros Order Form

# cielo

CLIENTE/client:  ORD. REF.:

QUANTITA'/quantity:  EMAIL:

INDICARE CON UN SEGNO LE FINITURE SCELTE PER I DIVERSI COMPONENTI

INDICATE WITH A TICK, THE CHOSEN FINISHES FOR ALL THE COMPONENTS

art. KYPL

## FINITURE PORTASCIUGAMANI IN LEGNO MASSELLO

SOLID WOOD TOWEL RAIL FINISHES

essenze legno/wood essences

- RO - Rovere Nero
- RG - Rovere Grigio
- RS - Rovere Sbiancato
- RN - Rovere Naturale

art. KYCL / art. KYCE

## FINITURE MOBILE IN LEGNO

CABINET WOODEN FINISHES

laccature/laquerings

- TL - Talco
- PM - Pomice
- BR - Brina
- AN - Arenaria
- AV - Avena
- CM - Cemento
- BA - Basalto
- MU - Muschio

essenze legno/wood essences

- RO - Rovere Nero
- RG - Rovere Grigio
- RS - Rovere Sbiancato
- RN - Rovere Naturale
- EU - Eucalipto

art. EKLAO \ EKLAOSF

## FINITURE LAVABO

WASHBASIN SHELF FINISHES

- Bianco/white - glossy

Le Terre di Cielo

- TL - Talco
- PM - Pomice
- BR - Brina
- BA - Basalto
- LV - Lavagna
- CM - Cemento
- FN - Fango
- CA - Cacao
- AN - Arenaria
- AV - Avena
- LN - Lino
- AG - Agave
- MU - Muschio
- PL - Polvere
- CP - Cipria
- CN - Canapa

art. KYST

## FINITURE STRUTTURA IN ACCIAIO

STEEL FRAMEWORK FINISHES

verniciature\_coatings

- NM - Nero Matt
- BZ - Bronzo Spazzolato
- CM - Cemento

**N.B. Il lavabo è monoforo predisposto 3 fori, su richiesta può essere prodotto senza foro**

*N.B. The washbasin has 1 hole prepared 3 holes ; may be made without holes upon request*

DATA  
DATE

FIRMA DEL CLIENTE  
SIGNATURE

ATTENZIONE:  
La rappresentazione delle finiture è puramente indicativa. Verificare le finiture con le relative cartelle.

Ogni oggetto possiede la peculiarità di essere elaborato secondo principi puramente tradizionali, in modo da garantirne l'assoluta originalità ed unicità. Le eventuali piccole variazioni di colore, tono o venature fra gli articoli sono da considerarsi pregi e non difetti, in quanto garanzia della fattura manuale del prodotto, che fa di ogni oggetto Cielo un pezzo unico ed esclusivo, lontano dall'omologazione industriale. In fase d'ordine si intendono, pertanto, accettate tali tolleranze che non possono dare adito a contestazioni di alcun genere.









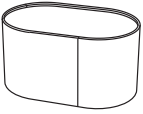

Verificare sempre le disponibilità e i tempi di consegna con il commerciale.

ATTENTION:  
The representation of the finishes is merely indicative. Please choose the finishes using the folders.

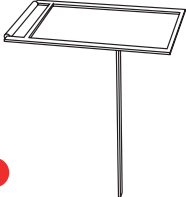
Every item possesses that particular feature of being processed according to purely traditional principles that guarantee its absolute originality and uniqueness. The small variations in colour, hues or streaks on the items are to be considered as qualities and not defects, since they warranty the handcrafted processing which makes each Cielo item a unique and exclusive piece that cannot be compared to industrial standardization. When making the order, the client implicitly accepts those various features that may give rise to claims of any sort.

Always check the availability and delivery time with the commercial department.

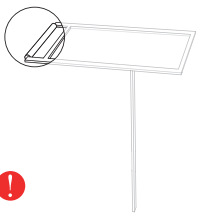

	Size (cm)	Product code	Net weight (Kg)	Finishes	Euro
	Medidas Dimensions Maße Размеры	Artículo Article Artikel Артикул	Peso neto Poids net Reingewicht вес нетто	Acabados Finitions Farbe Отделки	Евро
	78,5 x 50 x h85				
 <p><b>Ceramic washbasin with 1 hole</b> Lavabo de cerámica monoagujero Lavabo en céramique avec un trou Waschbecken aus Keramik mit 1 Hahnloch Керамическая раковина на одно отверстие</p>	70 x 50 x h20	EKLA0(X)*	20,00	 <b>Gloss White</b>	<b>724,00</b>
		EKLAOSF(X)* no tap hole sin agujero - sans orifice - ohne Loch без отверстия		 <b>Le Terre di Cielo</b>	<b>907,00</b>
 <p><b>Lacquered cabinet</b> Mueble lacado \ Meuble laqué \ Möbel lackiert \ Тумба крашенная</p>	60 x 38 x 34 h	KYCL(X)*	15,00	 <b>Le Terre di Cielo *</b>	<b>1300,00</b>
		 <p><b>Cabinet in wooden finish</b> Mueble en madera \ Meuble bois \ Möbel aus Holz \ Тумба в деревянной отделке</p>		KYCE(X)*	15,00
	60 x 38 x 34 h				
 <p><b>Steel framework</b> Estructura en acero Structure en acier Gestell aus Stahl Структура стальная</p>	77 x 50 x 84 h	KYST(X)*	8,50	 <b>*X = NM - Matt Black</b>	<b>688,00</b>
				 <b>*X = BZ - Brushed Bronze</b>	<b>994,00</b>
				 <b>*X = CM - Cemento</b>	<b>688,00</b>
 <p><b>Towel rail in solid wood</b> Toallero en madera maciza Porte-serviette en bois massif Handtuchhalter aus Massivholz Полотенцедержатель из массива дерева</p>	44 x Ø3	KYPL(X)*	0,18	 <b>EsSENze Rovere •</b>	<b>189,00</b>

**Mandatory combination: washbasin + cabinet + framework + towel rail**

combinaison obligatoire: lavabo + meuble + structure + toallero  
Combinación obligatoria: lavabo + meuble + estructura + porte-serviette  
obligatorische Kombination: Waschbecken + Unterbau + Gestell + Handtuchhalter  
обязательное сочетание: раковина + тумба + Структура + Полотенцедержатель.

**N.B.**  
The Eucalipto finish cabinet can only be combined with the Rovere Nero towel rail and the Nero Matt framework \ El mueble de acabado Eucalipto se fábrica solo con el toallero Rovere Nero y con la estructura metálica Nero Matt \ Das Möbel in der Ausführung Eukalyptus kann nur mit dem Handtuchhalter Eiche schwarz und mit dem Metallgestell matt Schwarz kombiniert werden \ Тумба в отделке Eucalipto комбинируется только с полотенцедержателем в отделке Rovere Nero и металлической структурой в отделке Nero Matt





















**Technical symbols legend** / Símbolos técnicos  
clave / Légende symboles techniques / Technische  
Zeichenerklärung / Перечень технических символов

 **with 1 hole prepared 3 holes**  
con 1 agujero predisposición para 3  
avec un trou prédisposition à trois trous  
mit 1-Loch auf 3-Loch durchschlagbar  
одно отверстие с возможностью  
выполнения трех отверстий

 **no tap hole on request**  
sin agujero, solo a petición  
sans orifice sur demande  
auf Anfrage ohne Loch  
без отверстия под смеситель  
по запросу

 **without overflow**  
sin rebosadero  
sans trop-plein  
ohne Überlauf  
без слива-перелива

 **all sides are enamelled**  
con todos los lados esmaltados  
avec tous les côtés émaillés  
alle Seiten glasiert  
все стороны покрыты эмалью

	Product code Artículo Article Artikel Артикул	Net weight <sub>(kg)</sub> Peso neto Poids net Reingewicht вес нетто	Finishes Acabados Finitions Farbe Отделки	Euro Евро
 <p><b>Universal click/clack drain in CHROME with ceramic lid</b> Válvula universal click/clack Cromado con tapa en cerámica Bonde universelle clic/clac Chromé avec clapet en céramique Universal-Abflussgarnitur Click-Clack Chrom mit Keramikstopfen Универсальный дренажный клапан click/clack хром с керамической крышкой</p>	PIL01(X)*	0,40	 <b>Gloss White</b>	<b>95,00</b>
			 <b>Le Terre di Cielo</b>	<b>139,00</b>
 <p><b>Universal click/clack drain in BLACK MATT finish with ceramic lid</b> Válvula universal click/clack Negro Matt con tapa en cerámica Bonde universelle clic/clac Noir Mat avec clapet en céramique Universal-Abflussgarnitur Click-Clack Matt Schwarz mit Keramikstopfen Универсальный дренажный клапан click/clack черный матовый с керамической крышкой</p>	PIL01NM(X)*	0,40	 <b>Gloss White</b>	<b>120,00</b>
			 <b>Le Terre di Cielo</b>	<b>169,00</b>
 <p><b>Universal click/clack drain in CEMENTO finish with ceramic lid</b> Válvula universal click/clack Cemento con tapa en cerámica Bonde universelle clic/clac Cemento avec clapet en céramique Universal-Abflussgarnitur Click-Clack Cement mit Keramikstopfen Универсальный дренажный Cemento click/clack с керамической крышкой</p>	PIL01CM(X)*	0,40	 <b>Gloss White</b>	<b>120,00</b>
			 <b>Le Terre di Cielo</b>	<b>169,00</b>
 <p><b>Universal click/clack drain in BRONZE with ceramic lid</b> Válvula universal click/clack Bronce con tapa en cerámica Bonde universelle clic/clac Bronze avec clapet en céramique Universal-Abflussgarnitur Click-Clack Bronze mit Keramikstopfen Универсальный дренажный клапан click/clack бронза с керамической крышкой</p>	PIL01BR(X)*	0,40	 <b>Gloss White</b>	<b>135,00</b>
			 <b>Le Terre di Cielo</b>	<b>182,00</b>
 <p><b>CHROMED siphon</b> Sifone Cromado \ Siphon Chromé \ Siphon Verchromt \ сифон Chrome</p>	SISP	0,93	 <b>Chrome</b>	<b>133,00</b>
 <p><b>MATT BLACK siphon</b> Sifone Negro Mate \ Siphon Noir Mat \ Siphon Schwarz Matt \ Сифон Черный матовый</p>	SIFN	0,93	 <b>Matt Black</b>	<b>194,00</b>
 <p><b>CEMENTO siphon</b> Sifone Cemento \ Siphon Cemento \ Siphon Cemento \ сифон Cemento</p>	SIFCM	0,93	 <b>Cemento</b>	<b>194,00</b>
 <p><b>BRONZE siphon</b> Sifone Bronce \ Siphon Bronce \ Siphon Bronze \ бронза сифон</p>	SIFBR	0,93	 <b>Bronze</b>	<b>220,00</b>

With the installation of the drawer, we recommend matching it with our SISP - SIFN - SIFCM - SIFBR siphons/traps / Con la instalación del cajón aconsejamos de combinar nuestros sifones SISP - SIFN - SIFCM - SIFBR / Terre di Cielo disponibles pour les lavabos et le plan en céramique / Bei Montage der Schublade empfehlen wir unsere Siphons SISP - SIFN - SIFCM - SIFBR / При установке ящика рекомендуем сочетать наши сифоны SISP - SIFN - SIFCM - SIFBR

Terre di Cielo available for ceramic washbasin / Terre di Cielo disponibles para lavabo de cerámica / Terre di Cielo disponibles pour les lavabos en céramique / Für Waschbecken erhältliche Terre di Cielo / Отделки Terre di Cielo доступны для раковин Тумба



\* Terre di Cielo laquering available for cabinet / lacados Terre di Cielo disponibles para mueble / laquages Terre di Cielo disponibles pour le meuble / Für Möbel erhältliche Lackierungen Terre di Cielo / крашенная отделка Terre di Cielo доступна для ящика и столешницы



• **Essenze Rovere**



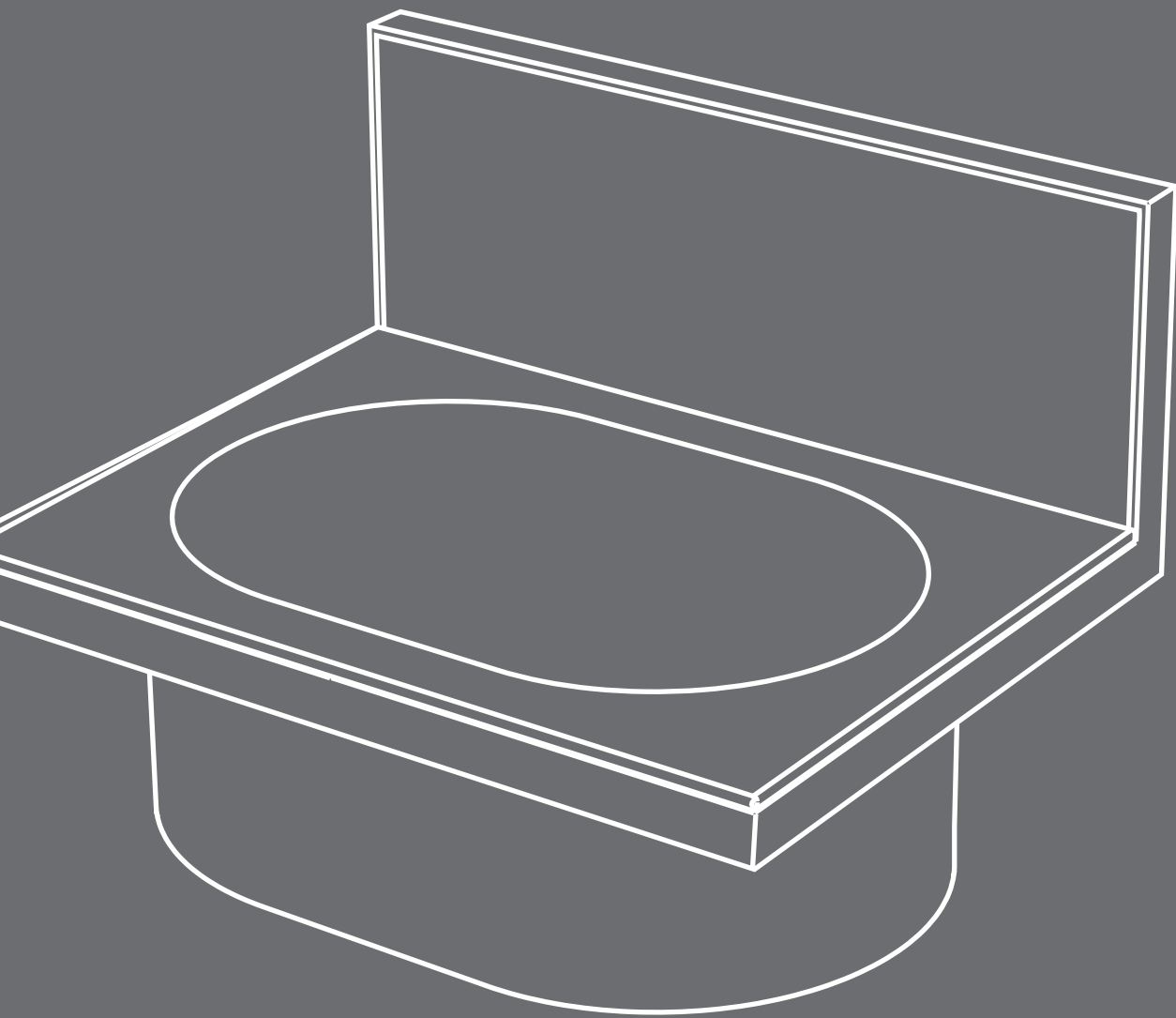

# Elle

design **Andrea Parisio & Giuseppe Pezzano**

## ELLE TONDA

QR code configuratore \ configurator pg. 228

indice collezione \ collection index pg. 229

modulo d'ordine \ order form pg. 231

listino prezzi \ price list pg. 236 - 239

## ELLE OVALE

QR code configuratore \ configurator pg. 232

indice collezione \ collection index pg. 233

modulo d'ordine \ order form pg. 235

listino prezzi \ price list pg. 240 - 243









Configure the product directly online and send the order to Cielo.

Configure el producto directamente online y envíe el pedido a Cielo.  
 Configurez le produit directement en ligne et envoyez la commande à Cielo.  
 Konfigurieren Sie Ihr Produkt online und schicken Sie die Bestellung direkt an Cielo.  
 Сконфигурируйте изделие в онлайн и перешлите заказ на фабрику Cielo.

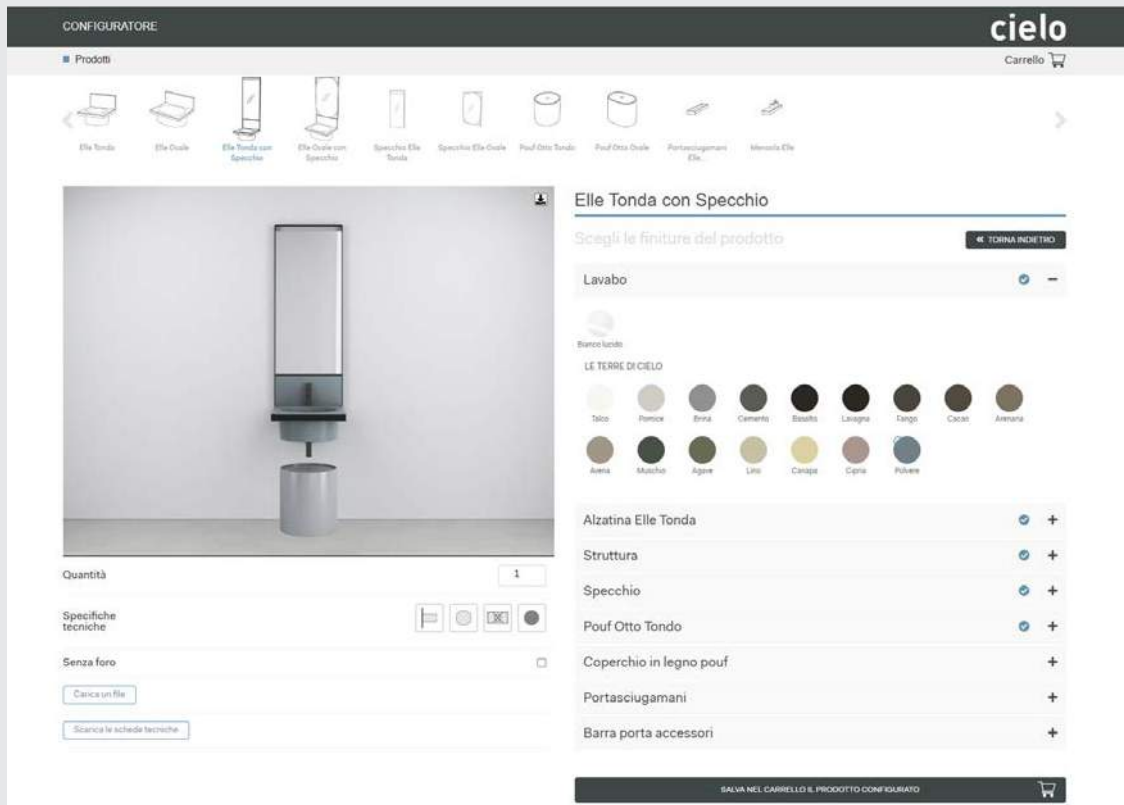

EN

SP

FR

RU



go to configurator



ir al configurador

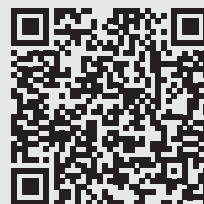

lien vers le configurateur

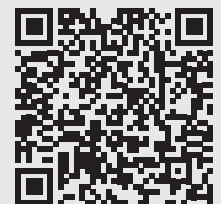

Перейдите в конфигурактор

# Elle Tonda

## Cabinet with washbasin

elementi che compongono Elle Tonda \ Elle Tonda components

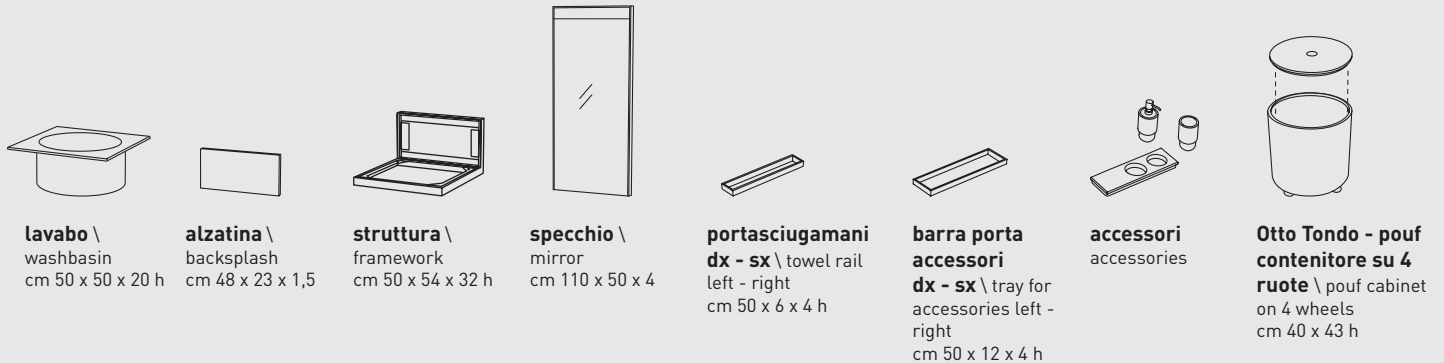

esempi di composizione \ examples of compositions

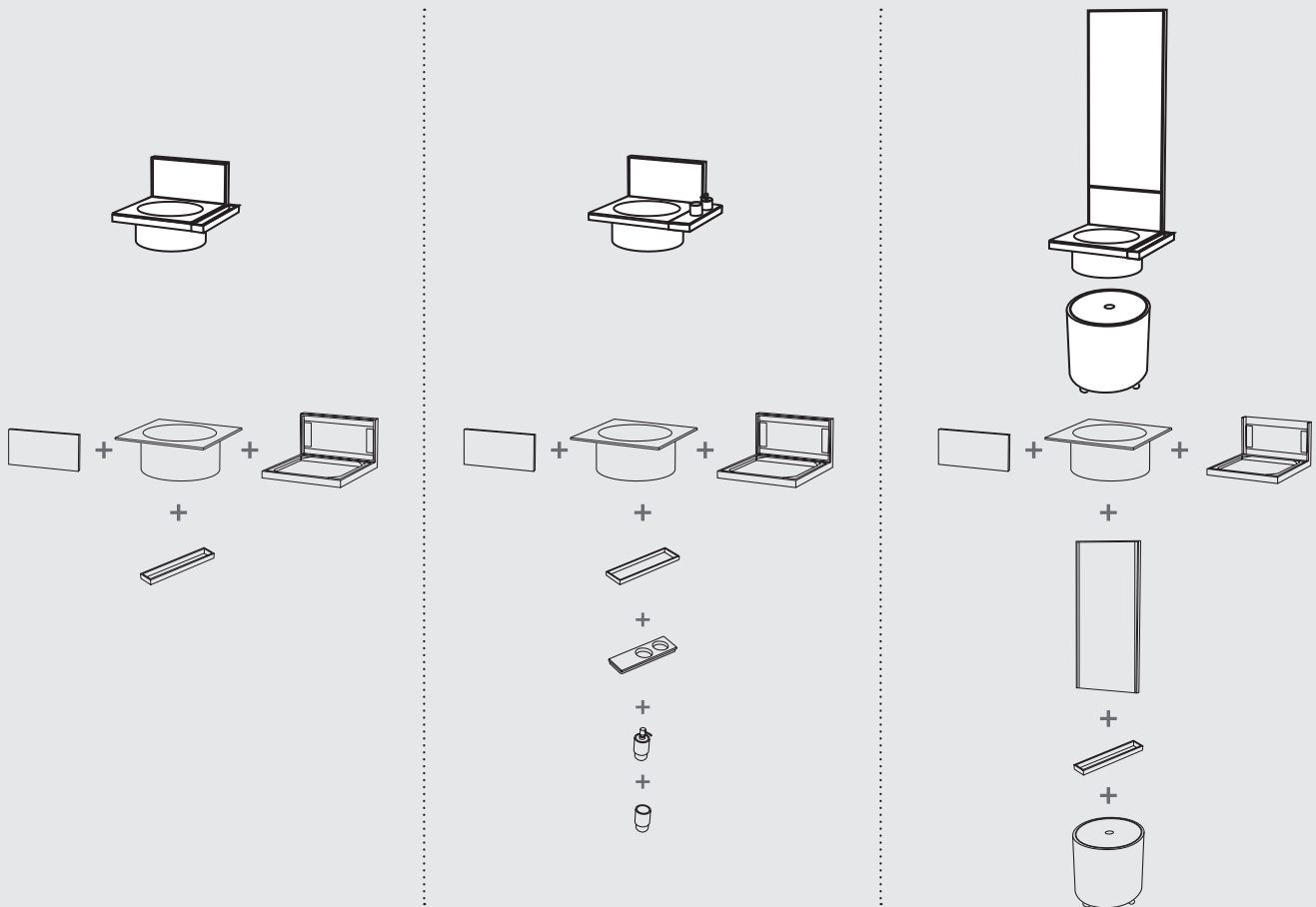

predisposizione fori rubinetteria \ predisposition of tap holes

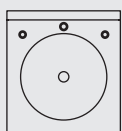

**lavabo \ washbasin:**  
**1 hole: 3 positions**  
1 agujero: 3 posiciones  
un trou: 3 positions  
1-Loch r: 3 Positionen  
одно отверстие: 3 позиции



**alzatina \ backsplash:**  
**The tap holes must be carried out by the installer. It is necessary to use a recessed adapter to compensate for the 4cm space between the wall and the tap.** \ Los agujeros para el grifo serán efectuados por el instalador. Es necesario el uso de un adaptador para el cuerpo empotrado para compensar el espacio de 4cm. Les trous pour le robinet devront être réalisés par l'installateur. Il est nécessaire d'utiliser un adaptateur pour groupe d'encastrement pour compenser l'espace de 4 cm. \ Die Hahnlöcher müssen vom Installateur ausgeführt werden. Es muss ein Adapter für Einbaugruppen verwendet werden, um den Abstand von 4 cm zu kompensieren. \ Отверстия под смеситель выполняются на месте установщиком. Для встроенного смесителя необходимо использовать переходник для компенсации 4 см.



# Elle Tonda



## modelli disponibili / available models

### ELLE TONDA collection

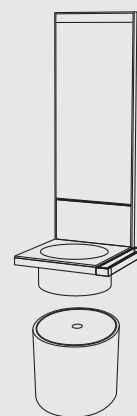

Elle Tonda lavabo con specchio  
Elle Tonda washbasin with mirror

## finiture / finishes

### LAVABO E ALZATINA IN CERAMICA / CERAMIC WASHBASIN AND BACK SPLASH



ELLAT / ELLATSF



ELP50

### FINITURE ACCESSORI IN LIVINGTEC ACCESSORY IN LIVINGTEC FINISHES



Bianco White

ELM50

ACBI

ACDI

### STRUTTURA IN ACCIAIO, PORTASCIUGAMANI, BARRA, CORNICE SPECCHIO IN ACCIAIO / STEEL FRAMEWORK, TOWEL RAIL, TRAY, FRAMEWORK MIRROR

#### verniciature / coatings



Nero Matt Matt Black

Bronzo Spazzolato Brushed Bronze

Cemento

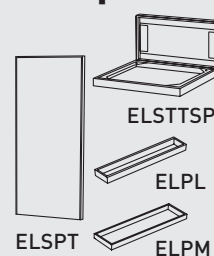

ELSPT

ELSTTSP

ELPL

ELPM

### OTTO - POUF CONTENITORE IN LIVINGTEC CON COPERCHIO IN LEGNO / POUF CABINET IN LIVINGTEC WITH WOODEN LID

#### POUF LivingTec

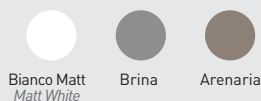

Bianco Matt Matt White

Brina

Arenaria

#### COPERCHIO IN LEGNO / WOODEN LID laccature / lacquers

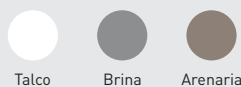

Talco

Brina

Arenaria

#### COPERCHIO IN LEGNO / WOODEN LID essenze / wooden finishes

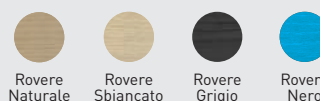

Rovere Naturale

Rovere Sbiancato

Rovere Grigio

Rovere Nero

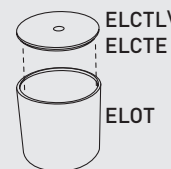

ELCTL\ ELCTE

ELOT

## note tecniche lavabo / washbasin technical notes

○  
monoforo: 3 posizioni  
1 hole: 3 positions

●  
senza foro su richiesta  
no tap hole on request

☒  
senza troppopieno  
without overflow

┌  
installazione su struttura  
sospesa  
installation on wall-hung  
framework

①  
composizione obbligatoria: lavabo +  
alzatina + struttura  
washbasin + backsplash + framework

CLIENTE/client:  ORD. REF.:

QUANTITA'/quantity:  EMAIL:

**INDICARE CON UN SEGNO LE FINITURE SCELTE PER I DIVERSI COMPONENTI**

**INDICATE WITH A TICK, THE CHOSEN FINISHES FOR ALL THE COMPONENTS**

art. **ELLAT - ELLATSF** \ art. **ELP50**

**FINITURE LAVABO E ALZATINA IN CERAMICA**  
CERAMIC WASHBASIN AND BACKSPASH FINISHES

Bianco/white - glossy

Le Terre di Cielo

<input type="radio"/> TL - Talco	<input type="radio"/> AN - Arenaria
<input type="radio"/> PM - Pomice	<input type="radio"/> AV - Avena
<input type="radio"/> BR - Brina	<input type="radio"/> LN - Lino
<input type="radio"/> BA - Basalto	<input type="radio"/> AG - Agave
<input type="radio"/> LV - Lavagna	<input type="radio"/> MU - Muschio
<input type="radio"/> CM - Cemento	<input type="radio"/> PL - Polvere
<input type="radio"/> FN - Fango	<input type="radio"/> CP - Cipria
<input type="radio"/> CA - Cacao	<input type="radio"/> CN - Canapa

art. **ELSPT** YES  NO

**FINITURE CORNICE SPECCHIO IN ACCIAIO**  
STEEL FRAMEWORK MIRROR FINISHES

verniciature\_coatings

NM - Nero Matt

BZ - Bronzo Spazzolato

CM - Cemento

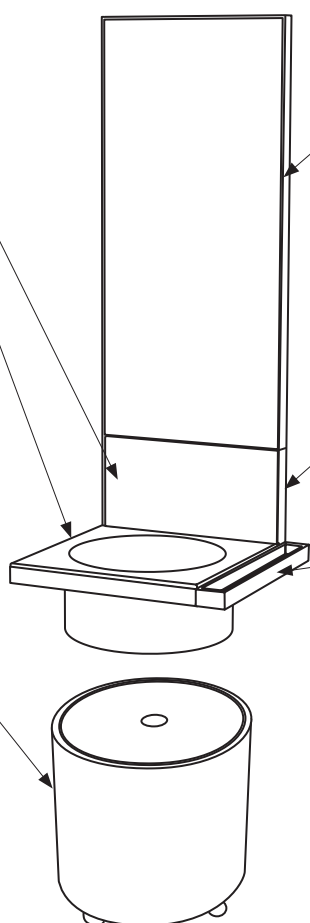

art. **ELSTT** \ art. **ELSTTSP**

**FINITURE STRUTTURA IN ACCIAIO**  
STEEL FRAMEWORK FINISHES

verniciature\_coatings

NM - Nero Matt

BZ - Bronzo Spazzolato

CM - Cemento

art. **ELOT** YES  NO

**FINITURE POUF CONTENITORE IN LIVINGTEC**  
POUF CABINET IN LIVINGTEC FINISHES

Bianco/white - matt

BR - Brina

AN - Arenaria

art. **ELPL** YES  NO

**FINITURE PORTASCIUGAMANI IN ACCIAIO**  
STEEL TOWEL RAIL FINISHES

verniciature\_coatings

NM - Nero Matt

BZ - Bronzo Spazzolato

CM - Cemento

art. **ELCTL** \ art. **ELCTE**

**FINITURE COPERCHIO IN LEGNO**  
WODEEN LID FINISHES

laccature/laquerings

Bianco/white - matt

BR - Brina

AN - Arenaria

essenze legno/wood essences

RO - Rovere Nero

RG - Rovere Grigio

RS - Rovere Sbiancato

RN - Rovere Naturale

art. **ELPM** YES  NO

**FINITURE BARRA PORTA ACCESSORI IN ACCIAIO**  
STEEL TRAY FOR ACCESSORIES FINISHES

verniciature\_coatings

NM - Nero Matt

BZ - Bronzo Spazzolato

CM - Cemento

**N.B. In caso di rubinetto su lavabo indicare posizione foro \**  
In case of tap-faucet on the sink indicate hole position

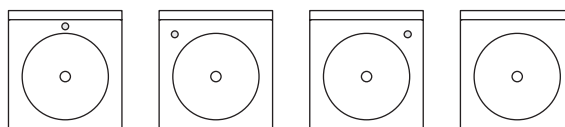

**CNTR**  standard position

**SX**

**DX**

**NO FORO**  NO TAP HOLE

art. **ELM50** YES  NO

**FINITURE MENSOLA IN LIVINGTEC**  
SHELF IN LIVINGTEC FINISHES

Bianco/white - matt

**DATA**  
DATE

**FIRMA DEL CLIENTE**  
SIGNATURE

ATTENZIONE:  
La rappresentazione delle finiture è puramente indicativa. Verificare le finiture con le relative cartelle.

Ogni oggetto possiede la peculiarità di essere elaborato secondo principi puramente tradizionali, in modo da garantirne l'assoluta originalità ed unicità. Le eventuali piccole variazioni di colore, tono o venature fra gli articoli sono da considerarsi pregi e non difetti, in quanto garanzia della fattura manuale del prodotto, che fa di ogni oggetto Cielo un pezzo unico ed esclusivo, lontano dall'omologazione industriale. In fase d'ordine si intendono, pertanto, accettate tali tolleranze che non possono dare adito a contestazioni di alcun genere.

Verificare sempre le disponibilità e i tempi di consegna con il commerciale.

ATTENTION:  
The representation of the finishes is merely indicative. Please choose the finishes using the folders.

Every item possesses that particular feature of being processed according to purely traditional principles that guarantee its absolute originality and uniqueness. The small variations in colour, hues or streaks on the items are to be considered as qualities and not defects, since they warranty the handcrafted processing which makes each Cielo item a unique and exclusive piece that cannot be compared to industrial standardization. When making the order, the client implicitly accepts those various features that may give rise to claims of any sort.

Always check the availability and delivery time with the commercial department.



Configure the product directly online and send the order to Cielo.

Configure el producto directamente online y envíe el pedido a Cielo.  
 Configurez le produit directement en ligne et envoyez la commande à Cielo.  
 Konfigurieren Sie Ihr Produkt online und schicken Sie die Bestellung direkt an Cielo.  
 Сконфигурируйте изделие в онлайн и перешлите заказ на фабрику Cielo.

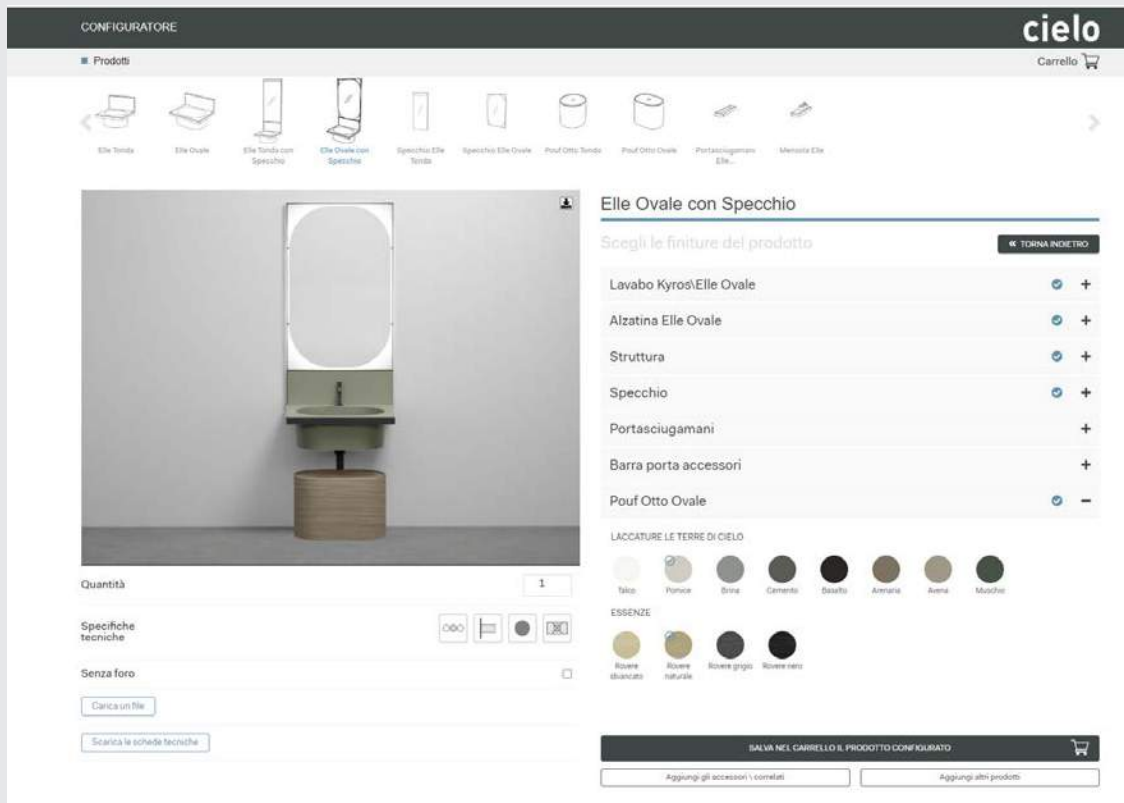

EN

SP

FR

RU

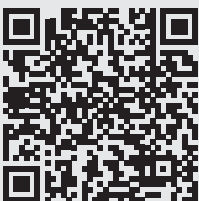

go to  
configurator

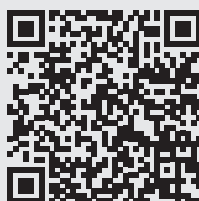

ir al  
configurador



lien vers le  
configurateur



Перейдите в  
конфигуратор

## Cabinet with washbasin

elementi che compongono Elle Ovale \ Elle Ovale components



## esempi di composizione \ examples of compositions

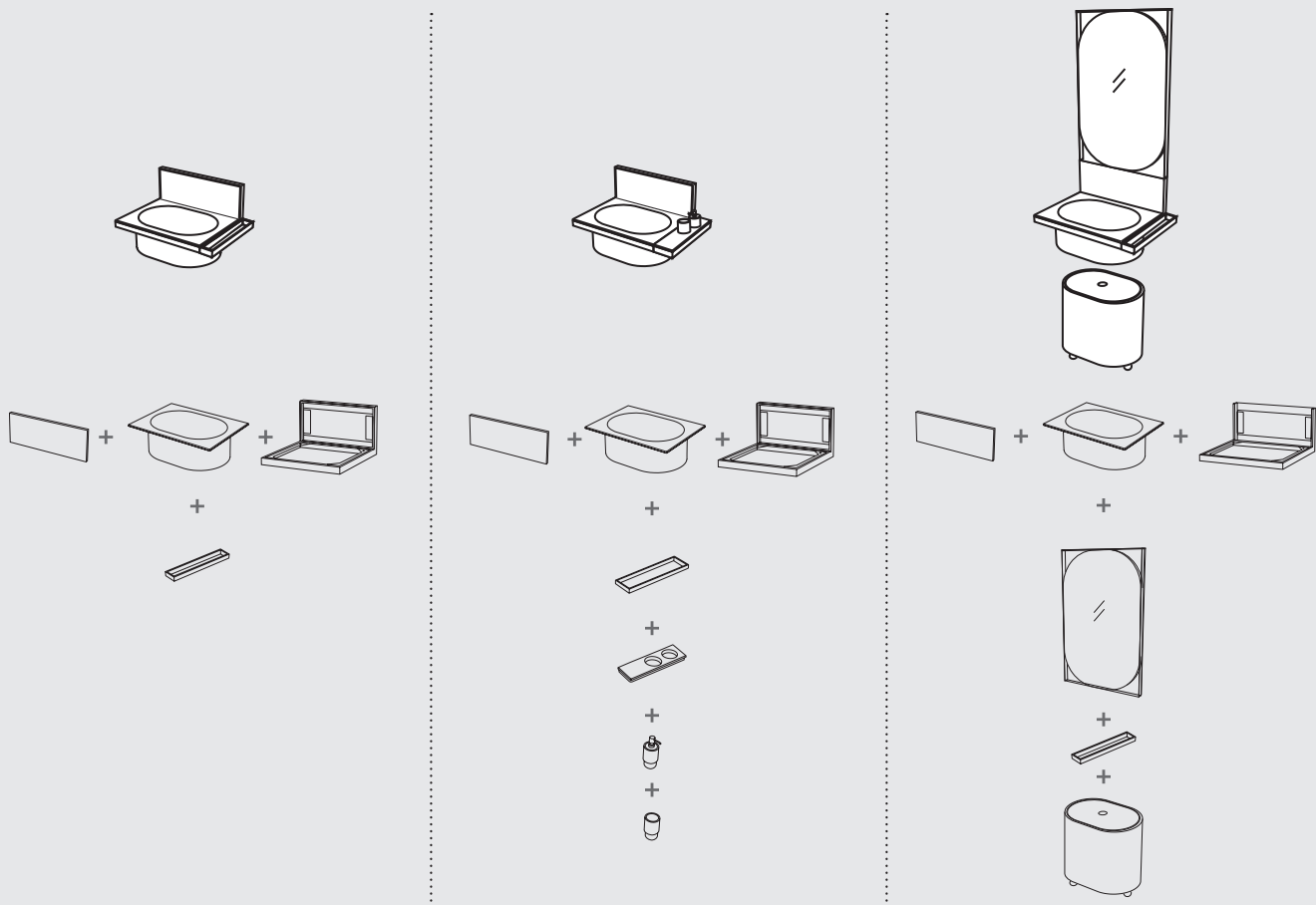

## predisposizione fori rubinetteria \ predisposition of tap holes

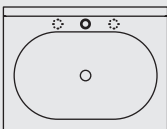

**washbasin with one hole prepared 3 holes, without tap hole on request**  
 con 1 agujero predisposto para 3, sin agujero, solo a petición \ avec un trou prédisposition à trois trous, sans orifice sur demande mit 1-Loch auf 3-Loch durchschlagbar, auf Anfrage ohne Loch \ одно отверстие с возможностью выполнения трех отверстий, без отверстия под смеситель по запросу



**alzatina \ backsplash:**

**The tap holes must be carried out by the installer. It is necessary to use a recessed adapter to compensate for the 4cm space between the wall and the tap.** \ Los agujeros para el grifo serán efectuados por el instalador. Es necesario el uso de un adaptador para el cuerpo empotrado para compensar el espacio de 4cm. Les trous pour le robinet devront être réalisés par l'installateur. Il est nécessaire d'utiliser un adaptateur pour groupe d'encastrement pour compenser l'espace de 4 cm. \ Die Hahnlöcher müssen vom Installateur ausgeführt werden. Es muss ein Adapter für Einbaugruppen verwendet werden, um den Abstand von 4 cm zu kompensieren. \ Отверстия под смеситель выполняются на месте установщиком. Для встраиваемого смесителя необходимо использовать переходник для компенсации 4 см.

# Elle Ovale



## modelli disponibili / available models

### ELLE OVALE collection

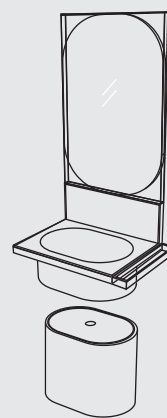

Elle Ovale lavabo con specchio  
Elle Ovale washbasin with mirror

## finiture / finishes

### LAVABO E ALZATINA IN CERAMICA / CERAMIC WASHBASIN AND BACK SPLASH

Bianco Lucido  
Glass White

Talco Pomice Brina Basalto Lavagna Cemento Fango Cacao Arenaria Avena Lino Agave Muschio Polvere Cipria Canapa

#### Le Terre di Cielo



EKLAO \ EKLAOSF

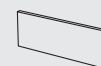

ELP70

+

### FINITURE ACCESSORI IN LIVINGTEC ACCESSORY IN LIVINGTEC FINISHES

Bianco  
White

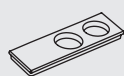

ELM50



ACBI ACDI

### STRUTTURA IN ACCIAIO, PORTASCIUGAMANI, BARRA, CORNICE SPECCHIO IN ACCIAIO / STEEL FRAMEWORK, TOWEL RAIL, TRAY, FRAMEWORK MIRROR

#### verniciature / coatings

Nero Matt  
Matt Black

Bronzo Spazzolato  
Brushed Bronze

Cemento

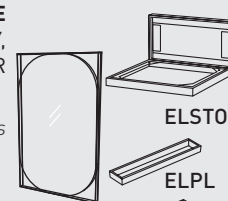

ELSTOSP



ELPL



ELPM

### OTTO OVALE - POUF CONTENITORE IN LEGNO / POUF CABINET IN WOOD

#### POUF + COPERCHIO / POUF + LID

#### essenze / wooden finishes

#### laccature / lacquers

#### Le Terre di Cielo

Talco Pomice Brina Arenaria Avena Cemento Basalto Muschio

Rovere Naturale  
Rovere Sbiancato  
Rovere Grigio  
Rovere Nero



ELOOL \ ELOOE

## note tecniche lavabo / washbasin technical notes

monoforo predisposto 3 fori  
with 1 hole prepared 3 holes

senza foro su richiesta  
no tap hole on request

senza troppopieno  
without overflow

installazione su struttura sospesa  
installation on wall-hung framework

composizione obbligatoria: lavabo +  
alzatina + struttura  
washbasin + backplash + framework

CLIENTE/client:  ORD. REF.:

QUANTITA'/quantity:  EMAIL:

**INDICARE CON UN SEGNO LE FINITURE SCELTE PER I DIVERSI COMPONENTI**

**INDICATE WITH A TICK, THE CHOSEN FINISHES FOR ALL THE COMPONENTS**

art. **EKLAO - EKLAOSF** \ art. **ELP70**

**FINITURE LAVABO E ALZATINA IN CERAMICA**  
CERAMIC WASHBASIN AND BACKSPLASH FINISHES

Bianco/white - glossy

Le Terre di Cielo

- |                                    |                                     |
|------------------------------------|-------------------------------------|
| <input type="radio"/> TL - Talco   | <input type="radio"/> AN - Arenaria |
| <input type="radio"/> PM - Pomice  | <input type="radio"/> AV - Avena    |
| <input type="radio"/> BR - Brina   | <input type="radio"/> LN - Lino     |
| <input type="radio"/> BA - Basalto | <input type="radio"/> AG - Agave    |
| <input type="radio"/> LV - Lavagna | <input type="radio"/> MU - Muschio  |
| <input type="radio"/> CM - Cemento | <input type="radio"/> PL - Polvere  |
| <input type="radio"/> FN - Fango   | <input type="radio"/> CP - Cipria   |
| <input type="radio"/> CA - Cacao   | <input type="radio"/> CN - Canapa   |

art. **ELSPO** YES  NO

**FINITURE CORNICE SPECCHIO IN ACCIAIO**  
STEEL FRAMEWORK MIRROR FINISHES

verniciature\_coatings

- NM - Nero Matt
- BZ - Bronzo Spazzolato
- CM - Cemento

art. **ELSTO** \ art. **ELSTOSP**

**FINITURE STRUTTURA IN ACCIAIO**  
STEEL FRAMEWORK FINISHES

verniciature\_coatings

- NM - Nero Matt
- BZ - Bronzo Spazzolato
- CM - Cemento

art. **ELOOL** / art. **ELOOE** YES  NO

**FINITURE POUF IN LEGNO**

POUF WOODEN FINISHES

laccature/laquerings

- TL - Talco
- PM - Pomice
- BR - Brina
- AN - Arenaria
- AV - Avena
- CM - Cemento
- BA - Basalto
- MU - Muschio

essenze legno/wood essences

- RO - Rovere Nero
- RG - Rovere Grigio
- RS - Rovere Sbiancato
- RN - Rovere Naturale

art. **ELPL** YES  NO

**FINITURE PORTASCIUGAMANI IN ACCIAIO**  
STEEL TOWEL RAIL FINISHES

verniciature\_coatings

- NM - Nero Matt
- BZ - Bronzo Spazzolato
- CM - Cemento

art. **ELPM** YES  NO

**FINITURE BARRA PORTA ACCESSORI IN ACCIAIO**  
STEEL TRAY FOR ACCESSORIES FINISHES

verniciature\_coatings

- NM - Nero Matt
- BZ - Bronzo Spazzolato
- CM - Cemento

art. **ELM50** YES  NO

**FINITURE MENSOLA IN LIVINGTEC**  
SHELF IN LIVINGTEC FINISHES

- Bianco/white - matt

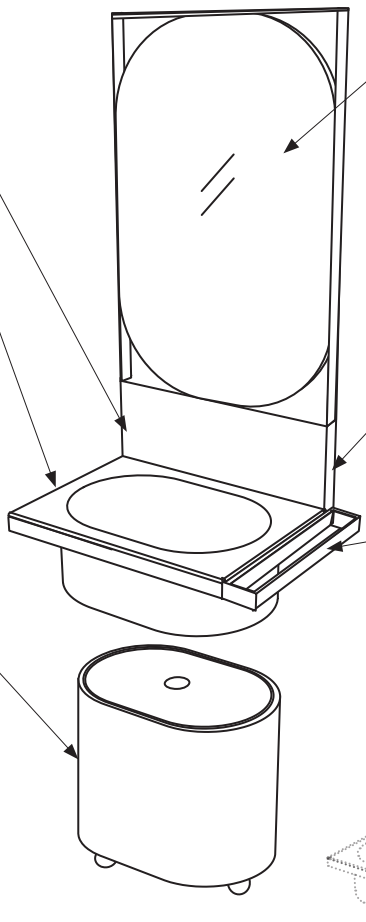

**N.B. Il lavabo è monoforo predisposto 3 fori, su richiesta può essere prodotto senza foro**

**N.B. The washbasin has 1 hole prepared 3 holes ; may be made without holes upon request**

DATA  
DATE

FIRMA DEL CLIENTE  
SIGNATURE

ATTENZIONE:  
La rappresentazione delle finiture è puramente indicativa. Verificare le finiture con le relative cartelle.

ATTENTION:  
The representation of the finishes is merely indicative. Please choose the finishes using the folders.

Ogni oggetto possiede la peculiarità di essere elaborato secondo principi puramente tradizionali, in modo da garantirne l'assoluta originalità ed unicità. Le eventuali piccole variazioni di colore, tono o venature fra gli articoli sono da considerarsi pregi e non difetti, in quanto garanzia della fattura manuale del prodotto, che fa di ogni oggetto Cielo un pezzo unico ed esclusivo, lontano dall'omologazione industriale. In fase d'ordine si intendono, pertanto, accettate tali tolleranze che non possono dare adito a contestazioni di alcun genere.

Every item possesses that particular feature of being processed according to purely traditional principles that guarantee its absolute originality and uniqueness. The small variations in colour, hues or streaks on the items are to be considered as qualities and not defects, since they warranty the handcrafted processing which makes each Cielo item a unique and exclusive piece that cannot be compared to industrial standardization. When making the order, the client implicitly accepts those various features that may give rise to claims of any sort.

Verificare sempre le disponibilità e i tempi di consegna con il commerciale.

Always check the availability and delivery time with the commercial department.

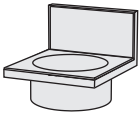















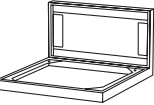



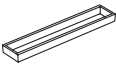







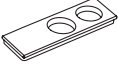







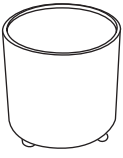

# Elle Tonda

composition without mirror

composición sin espejo | composition sans miroir | Komposition ohne Spiegel | Композиция без зеркала

# cielo

	Size (cm)	Product code	Net weight (Kg)	Finishes	Euro
	Medidas Dimensions Maße Размеры	Artículo Article Artikel Артикул	Peso neto Poids net Reingewicht вес нетто	Acabados Finitions Farbe Отделки	Евро
 <p><b>Ceramic washbasin with 1 hole (3 tap positions)</b> Lavabo en cerámica mono agujero (3 posiciones del grifo) \ lavabo en céramique monotrou (3 emplacement possible pour la robinetterie) \ Waschbecken aus Keramik, 1-Loch-Ausführung (3 Hahn-Positionen) \ Раковина керамическая с 1 отверстием (3-и варианта размещения смесителя)</p>	50 x 50 x h20	ELLAT(X)* ELLATSF(X)* no tap hole sin agujero sans orifice ohne Loch без отверстия	15,00	 <b>Gloss White</b>  <b>Le Terre di Cielo</b>	633,00 815,00
 <p><b>Ceramic backsplash (mandatory)</b> Base en cerámica (obligatorio) \ Credence en cerámica (nécessaire) \ Aufsatz aus Keramik (geböten) \ Пристенная панель из керамики (обязательный)</p>	48 x 1,5 x 23 h	ELP50(X)*	4,50	 <b>Gloss White</b>  <b>Le Terre di Cielo</b>	242,00 242,00
 <p><b>Steel framework (mandatory)</b> Estructura en acero (obligatorio) \ Structure en acier (nécessaire) \ Gestell aus Stahl (geböten) \ Структура стальная (обязательный)</p>	50 x 54 x 32 h	ELSTT(X)*	7,20	 *X = <b>NM - Matt Black</b> 504,00  *X = <b>BZ - Brushed Bronze</b> 737,00  *X = <b>CM - Cemento</b> 504,00	
 <p><b>Towel rail left \ right</b> Toallero lateral dcha. /izda. Porte-serviette latéral dx/sx Handtuchhalter seitlich re./li. Полотенцедержатель боковой справа/слева</p>	50 x 6 x 4 h	ELPL(X)*	1,80	 *X = <b>NM - Matt Black</b> 167,00  *X = <b>BZ - Brushed Bronze</b> 233,00  *X = <b>CM - Cemento</b> 167,00	
 <p><b>Tray for accessories left - right</b> Barra porta accesorios dcha. / izda. Barre porte accessoires Rahmen für Accessoire-Halter re./li. Держатель для аксессуаров справа/слева</p>	50 x 12 x 4 h	ELPM(X)*	2,00	 *X = <b>NM - Matt Black</b> 170,00  *X = <b>BZ - Brushed Bronze</b> 238,00  *X = <b>CM - Cemento</b> 170,00	
 <p><b>Shelf in LivingTec</b> Estante en LivingTec \ Tablette en LivingTec Konsole aus LivingTec \ Полочка in LivingTec</p>	50 x 12 x 2 h	ELM50	0,60	 <b>Matt White</b> 185,00	
 <p><b>Cup in LivingTec</b> Vaso en LivingTec \ Verre en LivingTec Glas aus LivingTec \ Стаканчик LivingTec</p>	Ø7 x h11	ACBI	0,30	 <b>Matt White</b> 73,00	
 <p><b>Dispenser in LivingTec (white glass in LivingTec with metal dispenser)</b> Dosificador en LivingTec (dosificador Blanco con dispensador de metal) \ Distributeur en LivingTec (Verre Blanc avec distributeur de métal) \ Spender aus LivingTec (Glas Weiß mit Metallspender) \ дозатор LivingTec (стаканчик белый, раздатчик металла)</p>	Ø7 x h15	ACDI	0,60	<b>metal part</b>  <b>NM - Matt Black</b> 213,00  <b>BZ - Brushed Bronze</b> 228,00  <b>CR - Chrome</b> 228,00  <b>CM - Cemento</b> 213,00	
 <p><b>Otto Tondo: round pouf cabinet in LivingTec on 4 wheels</b> pouf contenedor in Livingtec con 4 ruedas, con tapa en madera \ pouf conteneur in Livingtec su 4 ruote, con coperchio in legno - tabouret conteneur en living-tec à 4 roue, couvercle en bois \ Puff mit Stauraum aus LivingTec auf 4 Rollen, mit Deckel aus Holz \ Пуф круглый из материала Livingtec на 4-х колесиках, с крышкой деревянной</p>	40 x 40 x 43 h	ELOT(X)*	15,50	 <b>Matt White</b> 764,00  <b>Brina</b> 1146,00  <b>Arenaria</b> 1146,00	
 <p><b>Lacquered wooden lid</b> Tapa en madera lacada \ miroir in bois laqué \ Deckel aus lackiertem Holz \ Крышка крашенная деревянная</p>	Ø 36 x 2 h	ELCTL(X)*	1,40	 <b>Talco</b> 183,00  <b>Brina</b> 183,00  <b>Arenaria</b> 183,00	
 <p><b>Lid in wooden finish</b> Tapa en madera \ couvercle en bois \ Deckel aus Holz \ Крышка шпонирующая</p>	Ø 36 x 2 h	ELCTE(X)*	1,40	 <b>Essenze Rovere *</b> 242,00	

**! mandatory combination: washbasin + backsplash + framework**

combinación obligatoria: cubela + base en cerámica + mueble los agujeros \ combinaison obligatoire: vasque à poser Cielo + plan + estructura en acero \ obligatorische Kombination: Aufsatzbecken + Aufsatz aus Keramik + Gestell aus Stahl \ обязательное сочетание: Накладная + Пристенная панель из керамики + Структура стальная





















**Technical symbols legend / Simbolos técnicos**  
clave / Légende symboles techniques / Technische Zeichenerklärung / Перечень технических символов

 **with 1 hole** con 1 agujero avec un trou mit 1-Loch r одно отверстие

 **no tap hole on request** sin agujero, solo a petición sans orifice sur demande auf Anfrage ohne Loch без отверстия под смеситель по запросу

 **without overflow** sin rebosadero sans trop-plein ohne Überlauf без слива-перелива

 **wall-hung installation (only with framework)** instalación en estructura suspendida installation sur structure suspendue Installation auf einer abgehängten Struktur установка на подвесную конструкцию

	Product code Artículo Article Artikel Артикул	Net weight(kg) Peso neto Poids net Reingewicht вес нетто	Finishes Acabados Finitions Farbe Отделки	Euro Евро
 <p><b>Universal click/clack drain in CHROME with ceramic lid</b> Válvula universal click/clack Cromado con tapa en cerámica Bonde universelle clic/clac Chromé avec clapet en céramique Universal-Abflussgarnitur Click-Clack Chrom mit Keramikstopfen Универсальный донный клапан click/clack хром с керамической крышкой</p>	PIL01(X)*	0,40	 <b>Gloss White</b>	<b>95,00</b>
			 <b>Le Terre di Cielo</b>	<b>139,00</b>
 <p><b>Universal click/clack drain in BLACK MATT finish with ceramic lid</b> Válvula universal click/clack Negro Matt con tapa en cerámica Bonde universelle clic/clac Noir Mat avec clapet en céramique Universal-Abflussgarnitur Click-Clack Matt Schwarz mit Keramikstopfen Универсальный донный клапан click/clack черный матовый с керамической крышкой</p>	PIL01NM(X)*	0,40	 <b>Gloss White</b>	<b>120,00</b>
			 <b>Le Terre di Cielo</b>	<b>169,00</b>
 <p><b>Universal click/clack drain in CEMENTO finish with ceramic lid</b> Válvula universal click/clack Cemento con tapa en cerámica Bonde universelle clic/clac Cemento avec clapet en céramique Universal-Abflussgarnitur Click-Clack Cement mit Keramikstopfen Универсальный донный Cemento click/clack с керамической крышкой</p>	PIL01CM(X)*	0,40	 <b>Gloss White</b>	<b>120,00</b>
			 <b>Le Terre di Cielo</b>	<b>169,00</b>
 <p><b>Universal click/clack drain in BRONZE with ceramic lid</b> Válvula universal click/clack Bronce con tapa en cerámica Bonde universelle clic/clac Bronze avec clapet en céramique Universal-Abflussgarnitur Click-Clack Bronze mit Keramikstopfen Универсальный донный клапан click/clack бронза с керамической крышкой</p>	PIL01BR(X)*	0,40	 <b>Gloss White</b>	<b>135,00</b>
			 <b>Le Terre di Cielo</b>	<b>182,00</b>
 <p><b>CHROMED siphon</b> Sifone Cromado \ Siphon Chromé \ Siphon Verchromt \ сифон Chrome</p>	SISP	0,93	 <b>Chrome</b>	<b>133,00</b>
 <p><b>MATT BLACK siphon</b> Sifone Negro Mate \ Siphon Noir Mat \ Siphon Schwarz Matt \ Сифон Черный матовый</p>	SIFN	0,93	 <b>Matt Black</b>	<b>194,00</b>
 <p><b>CEMENTO siphon</b> Sifone Cemento \ Siphon Cemento \ Siphon Cemento \ сифон Cemento</p>	SIFCM	0,93	 <b>Cemento</b>	<b>194,00</b>
 <p><b>BRONZE siphon</b> Sifone Bronce \ Siphon Bronze \ Siphon Bronze \ бронза сифон</p>	SIFBR	0,93	 <b>Bronze</b>	<b>220,00</b>

## Terre di Cielo available for ceramic

**washbasin** | Terre di Cielo disponibles para lavabo de cerámica | Terre di Cielo disponibles pour les lavabos en céramique | Für Waschbecken erhältliche Terre di Cielo | Отделка Terre di Cielo доступны для раковин и керамических столешниц

-  TL - Talco
-  PM - Pomice
-  BR - Brina
-  BA - Basalto
-  LV - Lavagna
-  CM - Cemento
-  FN - Fango
-  CA - Cacao
-  AN - Arenaria
-  AV - Avena
-  LN - Lino
-  AG - Agave
-  MU - Muschio
-  PL - Polvere
-  CP - Cipria
-  CN - Canapa

## \* Essenze Rovere

-  RS - Rovere Sbiancato
-  RN - Rovere Naturale
-  RG - Rovere Grigio
-  RO - Rovere Nero



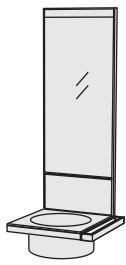

# Elle Tonda

composition with mirror

composición con espejo / composition avec miroir / Gestell aus Stahl für Spiegel / Композиция с зеркалом





















# cielo

	Size (cm) Medidas Dimensions Maße Размеры	Product code Artículo Article Artikel Артикул	Net weight (Kg) Peso neto Poids net Reingewicht вес нетто	Finishes Acabados Finitions Farbe Отделки	Euro Евро
<p><b>Ceramic washbasin with 1 hole (3 tap positions)</b> Lavabo en cerámica mono agujero (3 posiciones del grifo) \ Lavabo en céramique monotrou (3 emplacement possible pour la robinetterie) \ Waschbecken aus Keramik, 1-Loch-Ausführung (3 Hahn-Positionen) \ Раковина керамическая с 1 отверстием (3-и варианта размещения смесителя)</p>	50 x 50 x h20	ELLAT(X)* ELLATSF(X)* no tap hole sin agujero sans orifice ohne Loch без отверстия	15,00	Gloss White Le Terre di Cielo	633,00 815,00
<p><b>Ceramic backplash (mandatory)</b> Base en cerámica (obligatorio) \ Credence en ceramica (nécessaire) \ Aufsatz aus Keramik (geböten) \ Пристенная панель из керамики (обязательный)</p>	48 x 1,5 x 23 h	ELP50(X)*	4,50	Gloss White Le Terre di Cielo	242,00 242,00
<p><b>Steel framework for mirror (mandatory)</b> Estructura en acero para espejo (obligatorio) \ Structure en acier pour miroir (nécessaire) \ Gestell aus Stahl für Spiegel (geböten) \ Структура из стали под зеркало (обязательный)</p>	50 x 54 x 32 h	ELSTTSP(X)*	7,20	*X = NM - Matt Black *X = BZ - Brushed Bronze *X = CM - Cemento	504,00 737,00 504,00
<p><b>Rectangular mirror</b> Espejo rectangular \ Miroir rectangulaire \ Rechteckiger Spiegel \ прямоугольное зеркало</p>	50 x 4 x 110 h	ELSPT(X)*	16,50	*X = NM - Matt Black *X = BZ - Brushed Bronze *X = CM - Cemento	621,00 872,00 621,00
<p><b>Towel rail left \ right</b> Toallero lateral dcha. / izda. \ Porte-serviette latéral dx/sx \ Handtuchhalter seitlich re./li. \ Полотенцедержатель боковой справа/слева</p>	50 x 6 x 4 h	ELPL(X)*	1,80	*X = NM - Matt Black *X = BZ - Brushed Bronze *X = CM - Cemento	167,00 233,00 167,00
<p><b>Tray for accessories left - right</b> Barra porta accesorios dcha. / izda. \ Barre porte accessoires \ Rahmen für Accessoire-Halter re./li. \ Держатель для аксессуаров справа/ слева</p>	50 x 12 x 4 h	ELPM(X)*	2,00	*X = NM - Matt Black *X = BZ - Brushed Bronze *X = CM - Cemento	170,00 238,00 170,00
<p><b>Shelf in LivingTec</b> Estante en LivingTec \ Tablette en LivingTec \ Konsole aus LivingTec \ Полочка in LivingTec</p>	50 x 12 x 2 h	ELM50	0,60	Matt White	185,00
<p><b>Cup in LivingTec</b> Vaso en LivingTec \ Verre en LivingTec \ Glas aus LivingTec \ Стаканчик LivingTec</p>	Ø7 x h11	ACBI	0,30	Matt White	73,00
<p><b>Dispenser in LivingTec (white glass in LivingTec with metal dispenser)</b> Dosificador en LivingTec (dosificador Blanco con dispensador de metal) \ Distributeur en LivingTec (Verre Blanc avec distributeur de métal) \ Spender aus LivingTec (Glas Weiß mit Metallspender) \ дозатор LivingTec (стаканчик белый, раздатчик металла)</p>	Ø7 x h15	ACDI	0,60	metal part NM - Matt Black BZ - Brushed Bronze CR - Chrome CM - Cemento	213,00 228,00 228,00 213,00
<p><b>Otto Tondo: round pouf cabinet in LivingTec on 4 wheels</b> pouf contenedor in LivingTec con 4 ruedas, con tapa en madera \ pouf contenitore in Livingtec su 4 ruote, con coperchio in legno - tabouret conteneur en living-tec à 4 roue, couvercle en bois \ Puff mit Stauraum aus LivingTec auf 4 Rollen, mit Deckel aus Holz \ Пуф круглый из материала Livingtec на 4-х колесиках, с крышкой деревянной</p>	Ø 40 x 43 h	ELOT(X)*	15,50	Matt White Brina Arenaria	764,00 1146,00 1146,00
<p><b>Lacquered wooden lid</b> Tapa en madera lacada \ miroir en bois laqué \ Deckel aus lackiertem Holz \ Крышка крашенная деревянная</p>	Ø 36 x 2 h	ELCTL(X)*	1,40	Talco Brina Arenaria	183,00 183,00 183,00
<p><b>Lid in wooden finish</b> Tapa en madera \ couvercle en bois \ Deckel aus Holz \ Крышка шпонированная</p>	Ø 36 x 2 h	ELCTE(X)*	1,40	Essenze Rovere *	242,00



**mandatory combination: washbasin + backplash + framework**

combinaison obligatoire: cubela + base en cerámica + mueble los agujeros \ combinación obligatoria: vasque à poser Cielo + plan + estructura en acero \ obligatorische Kombination: Aufsatzbecken + Aufsatz aus Keramik + Gestell aus Stahl \ обязательное сочетание: Накладная + Пристенная панель из керамики + Структура стальная

	Product code Artículo Article Artikel Артикул	Net weight(kg) Peso neto Poids net Reingewicht вес нетто	Finishes Acabados Finitions Farbe Отделки	Euro Евро
 <p><b>Universal click/clack drain in CHROME with ceramic lid</b> Válvula universal click/clack Cromado con tapa en cerámica Bonde universelle clic/clac Chromé avec clapet en céramique Universal-Ablaufgarnitur Click-Clack Chrom mit Keramikstopfen Универсальный донный клапан click/clack хром с керамической крышкой</p>	PIL01(X)*	0,40	 <b>Gloss White</b>	<b>95,00</b>
			 <b>Le Terre di Cielo</b>	<b>139,00</b>
 <p><b>Universal click/clack drain in BLACK MATT finish with ceramic lid</b> Válvula universal click/clack Negro Matt con tapa en cerámica Bonde universelle clic/clac Noir Mat avec clapet en céramique Universal-Ablaufgarnitur Click-Clack Matt Schwarz mit Keramikstopfen Универсальный донный клапан click/clack черный матовый с керамической крышкой</p>	PIL01NM(X)*	0,40	 <b>Gloss White</b>	<b>120,00</b>
			 <b>Le Terre di Cielo</b>	<b>169,00</b>
 <p><b>Universal click/clack drain in CEMENTO finish with ceramic lid</b> Válvula universal click/clack Cemento con tapa en cerámica Bonde universelle clic/clac Cemento avec clapet en céramique Universal-Ablaufgarnitur Click-Clack Cement mit Keramikstopfen Универсальный донный Cemento click/clack с керамической крышкой</p>	PIL01CM(X)*	0,40	 <b>Gloss White</b>	<b>120,00</b>
			 <b>Le Terre di Cielo</b>	<b>169,00</b>
 <p><b>Universal click/clack drain in BRONZE with ceramic lid</b> Válvula universal click/clack Bronce con tapa en cerámica Bonde universelle clic/clac Bronce avec clapet en céramique Universal-Ablaufgarnitur Click-Clack Bronze mit Keramikstopfen Универсальный донный клапан click/clack бронза с керамической крышкой</p>	PIL01BR(X)*	0,40	 <b>Gloss White</b>	<b>135,00</b>
			 <b>Le Terre di Cielo</b>	<b>182,00</b>
 <p><b>CHROMED siphon</b> Sifone Cromado \ Siphon Chromé \ Siphon Verchromt \ сифон Chrome</p>	SISP	0,93	 <b>Chrome</b>	<b>133,00</b>
 <p><b>MATT BLACK siphon</b> Sifone Negro Mate \ Siphon Noir Mat \ Siphon Schwarz Matt \ Сифон Черный матовый</p>	SIFN	0,93	 <b>Matt Black</b>	<b>194,00</b>
 <p><b>CEMENTO siphon</b> Sifone Cemento \ Siphon Cemento \ Siphon Cemento \ сифон Cemento</p>	SIFCM	0,93	 <b>Cemento</b>	<b>194,00</b>
 <p><b>BRONZE siphon</b> Sifone Bronce \ Siphon Bronze \ Siphon Bronze \ бронза сифон</p>	SIFBR	0,93	 <b>Bronze</b>	<b>220,00</b>

**Technical symbols legend** / Símbolos técnicos  
clave / Légende symboles techniques / Technische  
Zeichenerklärung / Перечень технических символов

 **with 1 hole**  
con 1 agujero  
avec un trou  
mit 1-Loch  
одно отверстие

 **no tap hole on request**  
sin agujero, solo a petición  
sans orifice sur demande  
auf Anfrage ohne Loch  
без отверстия под смеситель  
по запросу

 **without overflow**  
sin rebosadero  
sans trop-plein  
ohne Überlauf  
без слива-перелива

 **wall-hung installation  
(only with framework)**  
instalación en estructura suspendida  
installation sur structure suspendue  
Installation auf einer abgehängten Struktur  
установка на подвесную конструкцию

**Terre di Cielo available for ceramic**

**washbasin** | Terre di Cielo disponibles para lavabo de cerámica | Terre di Cielo disponibles pour les lavabos en céramique | Für Waschbecken erhältliche Terre di Cielo | Отделка Terre di Cielo доступны для раковин и керамических столешниц

 TL - Talco   
  PM - Pomice   
  BR - Brina   
  BA - Basalto   
  LV - Lavagna   
  CM - Cemento  
 FN - Fango   
  CA - Cacao   
  AN - Arenaria   
  AV - Avena   
  LN - Lino   
  AG - Agave  
 MU - Muschio   
  PL - Polvere   
  CP - Cipria   
  CN - Canapa

**\* Essenze Rovere**

 RS - Rovere Sbiancato   
  RN - Rovere Naturale   
  RG - Rovere Grigio   
  RO - Rovere Nero

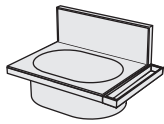









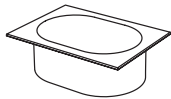













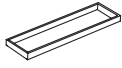



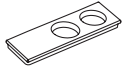



# Elle Ovale

composition without mirror

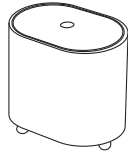
composición sin espejo | composition sans miroir | Komposition ohne Spiegel | Композиция без зеркала





















# cielo

	Size (cm) Medidas Dimensions Maße Размеры	Product code Artículo Article Artikel Артикул	Net weight (Kg) Peso neto Poids net Reingewicht вес нетто	Finishes Acabados Finitions Farbe Отделки	Euro Евро
 <p><b>Ceramic washbasin with 1 hole</b> Lavabo en cerámica mono agujero \ lavabo en céramique monotrou \ Waschbecken aus Keramik, 1-Loch-Ausführung \ Раковина керамическая с 1 отверстием</p> <p>! </p>	70 x 50 x h 20	EKLAO(X)* EKLAOSF(X)* no tap hole sin agujero sans orifice ohne Loch без отверстия	20,00	 Gloss White  Le Terre di Cielo	724,00 907,00
 <p><b>Ceramic backsplash (mandatory)</b> Base en cerámica (obligatorio) \ Credence en cerámica (nécessaire) \ Aufsatz aus Keramik (geböten) \ Пристенная панель из керамики (обязательный)</p>	68 x 1,5 x 23 h	ELP70(X)*	6,00	 Gloss White  Le Terre di Cielo	275,00 275,00
 <p><b>Steel framework (mandatory)</b> Estructura en acero (obligatorio) \ Structure en acier (nécessaire) \ Gestell aus Stahl (geböten) \ Структура стальная (обязательный)</p>	70 x 54 x 32 h	ELSTO(X)*	8,50	 *X = NM - Matt Black  *X = BZ - Brushed Bronze  *X = CM - Cemento	582,00 777,00 582,00
 <p><b>Towel rail left \ right</b> Toallero lateral dcha. /izda. Porte-serviette latéral dx/sx Handtuchhalter seitlich re./li. Полотенцедержатель боковой справа/слева</p>	50 x 6 x 4 h	ELPL(X)*	1,80	 *X = NM - Matt Black  *X = BZ - Brushed Bronze  *X = CM - Cemento	167,00 233,00 167,00
 <p><b>Tray for accessories left - right</b> Barra porta accesorios dcha. / izda. Barre porte accessoires Rahmen für Accessoire-Halter re./li. Держатель для аксессуаров справа/ слева</p>	50 x 12 x 4 h	ELPM(X)*	2,00	 *X = NM - Matt Black  *X = BZ - Brushed Bronze  *X = CM - Cemento	170,00 238,00 170,00
 <p><b>Shelf in LivingTec</b> Estante en LivingTec \ Tablette en LivingTec Konsole aus LivingTec \ Полочка in LivingTec</p>	50 x 12 x 2 h	ELM50	0,60	 Matt White	185,00
 <p><b>Cup in LivingTec</b> Vaso en LivingTec \ Verre en LivingTec Glas aus LivingTec \ Стаканчик LivingTec</p>	Ø7 x h11	ACBI	0,30	 Matt White	73,00
 <p><b>Dispenser in LivingTec (white glass in LivingTec with metal dispenser)</b> Dosificador en LivingTec (dosificador Blanco con dispensador de metal) \ Distributeur en LivingTec (Verre Blanc avec distributeur de métal) \ Spender aus LivingTec (Glas Weiß mit Metallspender) \ дозатор LivingTec (стаканчик белый, раздатчик металла)</p>	Ø7 x h15	ACDI	0,60	metal part  NM - Matt Black  BZ - Brushed Bronze  CR - Chrome  CM - Cemento	213,00 228,00 228,00 213,00
 <p><b>Otto Ovale: Lacquered oval pouf cabinet with wooden lid, on 4 wheels</b> Pouf ovalado, contenedor en madera lacada con tapa en madera, con ruedas \ Tabouret conteneur monté sur roulettes, en bois laqué, couvercle en bois \ Ovale Puff mit Stauraum, aus lackiertem Holz, mit Deckel aus Holz, auf Rollen \ Пуф овальный из материала Livingtec на 4-х колесиках, с крышкой деревянной крашенной</p>	60 x 38 x 43 h	ELOOL(X)*	18,00	 Le Terre di Cielo*	877,00
 <p><b>Otto Ovale: Oval pouf cabinet in wooden finish with wooden lid, on 4 wheels</b> Pouf ovalado, contenedor en madera con tapa en madera, con ruedas \ Tabouret conteneur monté sur roulettes, en bois, couvercle en bois \ Ovale Puff mit Stauraum, aus Holz, mit Deckel aus Holz, auf Rollen \ Пуф овальный из материала Livingtec на 4-х колесиках, с крышкой деревянной шпонированной</p>	60 x 38 x 43 h	ELOOE(X)*	18,00	 Essenze Rovere *	1097,00







**mandatory combination: washbasin + backsplash + framework**

combinaison obligatoire: cubela + base en cerámica + mueble los agujeros \ combinación obligatoria: vasque à poser Cielo + plan + estructura en acero \ obligatorische Kombination: Aufsatzbecken + Aufsatz aus Keramik + Gestell aus Stahl \ обязательное сочетание: Накладная + Пристенная панель из керамики + Структура стальная

	<b>Product code</b> Artículo Article Artikel Артикул	<b>Net weight</b> (Kg) Peso neto Poids net Reingewicht вес нетто	<b>Finishes</b> Acabados Finitions Farbe Отделки	<b>Euro</b> Евро
 <p><b>Universal click/clack drain in CHROME with ceramic lid</b> Válvula universal click/clack Cromado con tapa en cerámica Bonde universelle clic/clac Chromé avec clapet en céramique Universal-Abflussgarnitur Click-Clack Chrom mit Keramikstopfen Универсальный донный клапан click/clack хром с керамической крышкой</p>	PIL01(X)*	0,40	 <b>Gloss White</b>	<b>95,00</b>
			 <b>Le Terre di Cielo</b>	<b>139,00</b>
 <p><b>Universal click/clack drain in BLACK MATT finish with ceramic lid</b> Válvula universal click/clack Negro Matt con tapa en cerámica Bonde universelle clic/clac Noir Mat avec clapet en céramique Universal-Abflussgarnitur Click-Clack Matt Schwarz mit Keramikstopfen Универсальный донный клапан click/clack черный матовый с керамической крышкой</p>	PIL01NM(X)*	0,40	 <b>Gloss White</b>	<b>120,00</b>
			 <b>Le Terre di Cielo</b>	<b>169,00</b>
 <p><b>Universal click/clack drain in CEMENTO finish with ceramic lid</b> Válvula universal click/clack Cemento con tapa en cerámica Bonde universelle clic/clac Cemento avec clapet en céramique Universal-Abflussgarnitur Click-Clack Cement mit Keramikstopfen Универсальный донный Cemento click/clack с керамической крышкой</p>	PIL01CM(X)*	0,40	 <b>Gloss White</b>	<b>120,00</b>
			 <b>Le Terre di Cielo</b>	<b>169,00</b>
 <p><b>Universal click/clack drain in BRONZE with ceramic lid</b> Válvula universal click/clack Bronce con tapa en cerámica Bonde universelle clic/clac Bronze avec clapet en céramique Universal-Abflussgarnitur Click-Clack Bronze mit Keramikstopfen Универсальный донный клапан click/clack бронза с керамической крышкой</p>	PIL01BR(X)*	0,40	 <b>Gloss White</b>	<b>135,00</b>
			 <b>Le Terre di Cielo</b>	<b>182,00</b>
 <p><b>CHROMED siphon</b> Sifone Cromado \ Siphon Chromé \ Siphon Verchromt \ сифон Chrome</p>	SISP	0,93	 <b>Chrome</b>	<b>133,00</b>
 <p><b>MATT BLACK siphon</b> Sifone Negro Mate \ Siphon Noir Mat \ Siphon Schwarz Matt \ Сифон Черный матовый</p>	SIFN	0,93	 <b>Matt Black</b>	<b>194,00</b>
 <p><b>CEMENTO siphon</b> Sifone Cemento \ Siphon Cemento \ Siphon Cemento \ сифон Cemento</p>	SIFCM	0,93	 <b>Cemento</b>	<b>194,00</b>
 <p><b>BRONZE siphon</b> Sifone Bronce \ Siphon Bronze \ Siphon Bronze \ бронза сифон</p>	SIFBR	0,93	 <b>Bronze</b>	<b>220,00</b>

**Technical symbols legend** / *Simbolos técnicos clave* / *Légende symboles techniques* / *Technische Zeichenerklärung* / *Перечень технических символов*

-  **with 1 hole**  
con 1 agujero  
avec un trou  
mit 1-Loch  
одно отверстие
-  **no tap hole on request**  
sin agujero, solo a petición  
sans orifice sur demande  
auf Anfrage ohne Loch  
ohne Überlauf  
без слива-перелива
-  **without overflow**  
sin rebosadero  
sans trop-plein  
ohne Überlauf  
без слива-перелива
-  **wall-hung installation (only with framework)**  
instalación en estructura suspendida  
installation sur structure suspendue  
Installation auf einer abgehängten Struktur  
установка на подвесную конструкцию





**Terre di Cielo available for ceramic washbasin and backsplash**

*| Terre di Cielo disponibles para lavabo y base de cerámica | Terre di Cielo disponibles pour les lavabos et credence en céramique | Für Waschbecken erhältliche Terre di Cielo | Отделка Terre di Cielo доступны для раковин и керамических столешниц*

-  **TL - Talco**
-  **PM - Pomice**
-  **BR - Brina**
-  **BA - Basalto**
-  **LV - Lavagna**
-  **CM - Cemento**
-  **FN - Fango**
-  **CA - Cacao**
-  **AN - Arenaria**
-  **AV - Avena**
-  **LN - Lino**
-  **AG - Agave**
-  **MU - Muschio**
-  **PL - Polvere**
-  **CP - Cipria**
-  **CN - Canapa**

**\* Terre di Cielo laquering available for pouf and lid**

*| lacados Terre di Cielo disponibles para pouf y tapa | laquages Terre di Cielo disponibles pour le pouf et | Für Puff erhältliche Lackierungen Terre di Cielo | крашенная отделка Terre di Cielo доступна для ящика и столешницы*

-  **TL - Talco**
-  **PM - Pomice**
-  **BR - Brina**
-  **AN - Arenaria**
-  **AV - Avena**
-  **CM - Cemento**
-  **BA - Basalto**
-  **MU - Muschio**

**\* Essenze Rovere**

-  **RS - Rovere Sbiancato**
-  **RN - Rovere Naturale**
-  **RG - Rovere Grigio**
-  **RO - Rovere Nero**

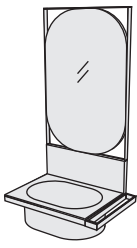









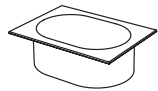













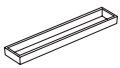







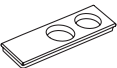



# Elle Ovale

composition with mirror

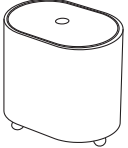
composición con espejo / composition avec miroir / Gestell aus Stahl für Spiegel / Композиция с зеркалом

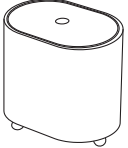



















# cielo

	Size (cm)	Product code	Net weight (Kg)	Finishes	Euro
	Medidas Dimensions Maße Размеры	Artículo Article Artikel Артикул	Peso neto Poids net Reingewicht вес нетто	Acabados Finitions Farbe Отделки	Евро
 <p><b>Ceramic washbasin with 1 hole</b> Lavabo de cerámica monoagujero Lavabo en céramique avec un trou Washbecken aus Keramik mit 1 Hahnloch Керамическая раковина на одно отверстие</p>	70 x 50 x 20 h	EKLAO(X)* EKLAOSF(X)* <small>no tap hole sin agujero sans orifice ohne Loch без отверстия</small>	20,00	 Gloss White  Le Terre di Cielo	724,00 907,00
 <p><b>Ceramic backplash (mandatory)</b> Base en cerámica (obligatorio) \ Credence en cerámica (nécessaire) \ Aufsatz aus Keramik (geböten) \ Пристенная панель из керамики (обязательный)</p>	68 x 1,5 x 23 h	ELP70(X)*	6,00	 Gloss White  Le Terre di Cielo	275,00 275,00
 <p><b>Steel framework for mirror (mandatory)</b> Estructura en acero para espejo (obligatorio) \ Structure en acier pour miroir (nécessaire) \ Gestell aus Stahl für Spiegel (geböten) \ Структура из стали под зеркало (обязательный)</p>	70 x 54 x 32 h	ELSTOSP(X)*	8,50	 *X = NM - Matt Black  *X = BZ - Brushed Bronze  *X = CM - Cemento	582,00 777,00 582,00
 <p><b>Oval mirror with perimeter LED light</b> Espejo ovalado con lu led perimetral \ miroir oval avec lumière LED en périmètre \ Ovaler Spiegel mit umlaufender LED-Beleuchtung \ Зеркало овальное со светодиодной подсветкой по периметру</p>	70 x 4 x 110 h	ELSP0(X)*	20,00	 *X = NM - Matt Black  *X = BZ - Brushed Bronze  *X = CM - Cemento	1338,00 1758,00 1338,00
 <p><b>Towel rail left \ right</b> Toallero lateral dcha. / izda. Porte-serviette latéral dx/sx Handtuchhalter seitlich re./li. Полотенцедержатель боковой справа/слева</p>	50 x 6 x 4 h	ELPL(X)*	1,80	 *X = NM - Matt Black  *X = BZ - Brushed Bronze  *X = CM - Cemento	167,00 233,00 167,00
 <p><b>Tray for accessories left - right</b> Barra porta accesorios dcha. / izda. Barre porte accessoires Rahmen für Accessoire-Halter re./li. Держатель для аксессуаров справа/ слева</p>	50 x 12 x 4 h	ELPM(X)*	2,00	 *X = NM - Matt Black  *X = BZ - Brushed Bronze  *X = CM - Cemento	170,00 238,00 170,00
 <p><b>Shelf in LivingTec</b> Estante en LivingTec \ Tablette en LivingTec Konsole aus LivingTec \ Полочка in LivingTec</p>	50 x 12 x 2 h	ELM50	0,60	 Matt White	185,00
 <p><b>Cup in LivingTec</b> Vaso en LivingTec \ Verre en LivingTec Glas aus LivingTec \ Стаканчик LivingTec</p>	Ø7 x h11	ACBI	0,30	 Matt White	73,00
 <p><b>Dispenser in LivingTec (white glass in LivingTec with metal dispenser)</b> Dosificador en LivingTec (dosificador Blanco con dispensador de metal) \ Distributeur en LivingTec (Verre Blanc avec distributeur de métal) \ Spender aus LivingTec (Glas Weiß mit Metallspender) \ дозатор LivingTec (стаканчик белый, раздатчик металла)</p>	Ø7 x h15	ACDI	0,60	metal part  NM - Matt Black  BZ - Brushed Bronze  CR - Chrome  CM - Cemento	213,00 228,00 228,00 213,00
 <p><b>Otto Ovale: Lacquered oval pouf cabinet with wooden lid, on 4 wheels</b> Pouf ovalado, contenedor en madera lacada con tapa en madera, con ruedas \ Tabouret conteneur monté sur roulettes, en bois laqué, couvercle en bois \ Ovaler Puff mit Stauraum, aus lackiertem Holz, mit Deckel aus Holz, auf Rollen \ Пуф овальный из материала Livingtec на 4-х колесиках, с крышкой деревянной крашенной</p>	60 x 38 x 43 h	ELOOL(X)*	18,00	 Le Terre di Cielo*	877,00
 <p><b>Otto Ovale: Oval pouf cabinet in wooden finish with wooden lid, on 4 wheels</b> Pouf ovalado, contenedor en madera con tapa en madera, con ruedas \ Tabouret conteneur monté sur roulettes, en bois, couvercle en bois \ Ovaler Puff mit Stauraum, aus Holz, mit Deckel aus Holz, auf Rollen \ Пуф овальный из материала Livingtec на 4-х колесиках, с крышкой деревянной шпонирующей</p>	60 x 38 x 43 h	ELOOE(X)*	18,00	 Essenze Rovere *	1097,00



**mandatory combination: washbasin + backplash + framework**

combinación obligatoria: cubela + base en cerámica + mueble los agujeros \ combinaison obligatoire: vasque à poser Cielo + plan + estructura en acero \ obligatorische Kombination: Aufsatzbecken + Aufsatz aus Keramik + Gestell aus Stahl \ обязательное сочетание: Накладная + Пристенная панель из керамики + Структура стальная

	<b>Product code</b> Artículo Article Artikel Артикул	<b>Net weight</b> (Kg) Peso neto Poids net Reingewicht вес нетто	<b>Finishes</b> Acabados Finitions Farbe Отделки	<b>Euro</b> Евро
 <p><b>Universal click/clack drain in CHROME with ceramic lid</b> Válvula universal click/clack Cromado con tapa en cerámica Bonde universelle clic/clac Chromé avec clapet en céramique Universal-Ablaufgarnitur Click-Clack Chrom mit Keramikstopfen Универсальный донный клапан click/clack хром с керамической крышкой</p>	PIL01(X)*	0,40	 <b>Gloss White</b>	95,00
			 <b>Le Terre di Cielo</b>	139,00
 <p><b>Universal click/clack drain in BLACK MATT finish with ceramic lid</b> Válvula universal click/clack Negro Matt con tapa en cerámica Bonde universelle clic/clac Noir Mat avec clapet en céramique Universal-Ablaufgarnitur Click-Clack Matt Schwarz mit Keramikstopfen Универсальный донный клапан click/clack черный матовый с керамической крышкой</p>	PIL01NM(X)*	0,40	 <b>Gloss White</b>	120,00
			 <b>Le Terre di Cielo</b>	169,00
 <p><b>Universal click/clack drain in CEMENTO finish with ceramic lid</b> Válvula universal click/clack Cemento con tapa en cerámica Bonde universelle clic/clac Cemento avec clapet en céramique Universal-Ablaufgarnitur Click-Clack Cement mit Keramikstopfen Универсальный донный Cemento click/clack с керамической крышкой</p>	PIL01CM(X)*	0,40	 <b>Gloss White</b>	120,00
			 <b>Le Terre di Cielo</b>	169,00
 <p><b>Universal click/clack drain in BRONZE with ceramic lid</b> Válvula universal click/clack Bronce con tapa en cerámica Bonde universelle clic/clac Bronce avec clapet en céramique Universal-Ablaufgarnitur Click-Clack Bronze mit Keramikstopfen Универсальный донный клапан click/clack бронза с керамической крышкой</p>	PIL01BR(X)*	0,40	 <b>Gloss White</b>	135,00
			 <b>Le Terre di Cielo</b>	182,00
 <p><b>CHROMED siphon</b> Sifone Cromado \ Siphon Chromé \ Siphon Verchromt \ сифон Chrome</p>	SISP	0,93	 <b>Chrome</b>	133,00
 <p><b>MATT BLACK siphon</b> Sifone Negro Mate \ Siphon Noir Mat \ Siphon Schwarz Matt \ Сифон Черный матовый</p>	SIFN	0,93	 <b>Matt Black</b>	194,00
 <p><b>CEMENTO siphon</b> Sifone Cemento \ Siphon Cemento \ Siphon Cemento \ сифон Cemento</p>	SIFCM	0,93	 <b>Bronze</b>	194,00
 <p><b>BRONZE siphon</b> Sifone Bronce \ Siphon Bronze \ Siphon Bronze \ бронза сифон</p>	SIFBR	0,93	 <b>Bronze</b>	220,00

**Technical symbols legend / Símbolos técnicos**  
clave | Légende symboles techniques | Technische Zeichenerklärung | Перечень технических символов

 **with 1 hole**  
con 1 agujero  
avec un trou  
mit 1-Loch  
одно отверстие

 **no tap hole on request**  
sin agujero, solo a petición  
sans orifice sur demande  
auf Anfrage ohne Loch  
без отверстия под смеситель по запросу

 **without overflow**  
sin rebosadero  
sans trop-plein  
ohne Überlauf  
без слива-перелива

 **wall-hung installation**  
(only with framework)  
instalación en estructura suspendida  
installation sur structure suspendue  
Installation auf einer abgehängten Struktur  
установка на подвесную конструкцию







### Terre di Cielo available for ceramic

**washbasin and backsplash** | Terre di Cielo disponibles para lavabo y base de cerámica | Terre di Cielo disponibles pour les lavabos et credence en céramique | Für Waschbecken erhältliche Terre di Cielo | Отделка Terre di Cielo доступны для раковин и керамических столешниц

-  TL - Talco
-  PM - Pomice
-  BR - Brina
-  BA - Basalto
-  LV - Lavagna
-  CM - Cemento
-  FN - Fango
-  CA - Cacao
-  AN - Arenaria
-  AV - Avena
-  LN - Lino
-  AG - Agave
-  MU - Muschio
-  PL - Polvere
-  CP - Cipria
-  CN - Canapa

### \* Terre di Cielo laquering available for pouf and lid

| lacados Terre di Cielo disponibles para pouf y tapa | laquages Terre di Cielo disponibles pour le pouf et | Für Puff erhältliche Lackierungen Terre di Cielo | крашенная отделка Terre di Cielo доступна для ящика и столешницы

-  TL - Talco
-  PM - Pomice
-  BR - Brina
-  AN - Arenaria
-  AV - Avena
-  CM - Cemento
-  BA - Basalto
-  MU - Muschio

### \* Essenze Rovere

-  RS - Rovere Sbiancato
-  RN - Rovere Naturale
-  RG - Rovere Grigio
-  RO - Rovere Nero



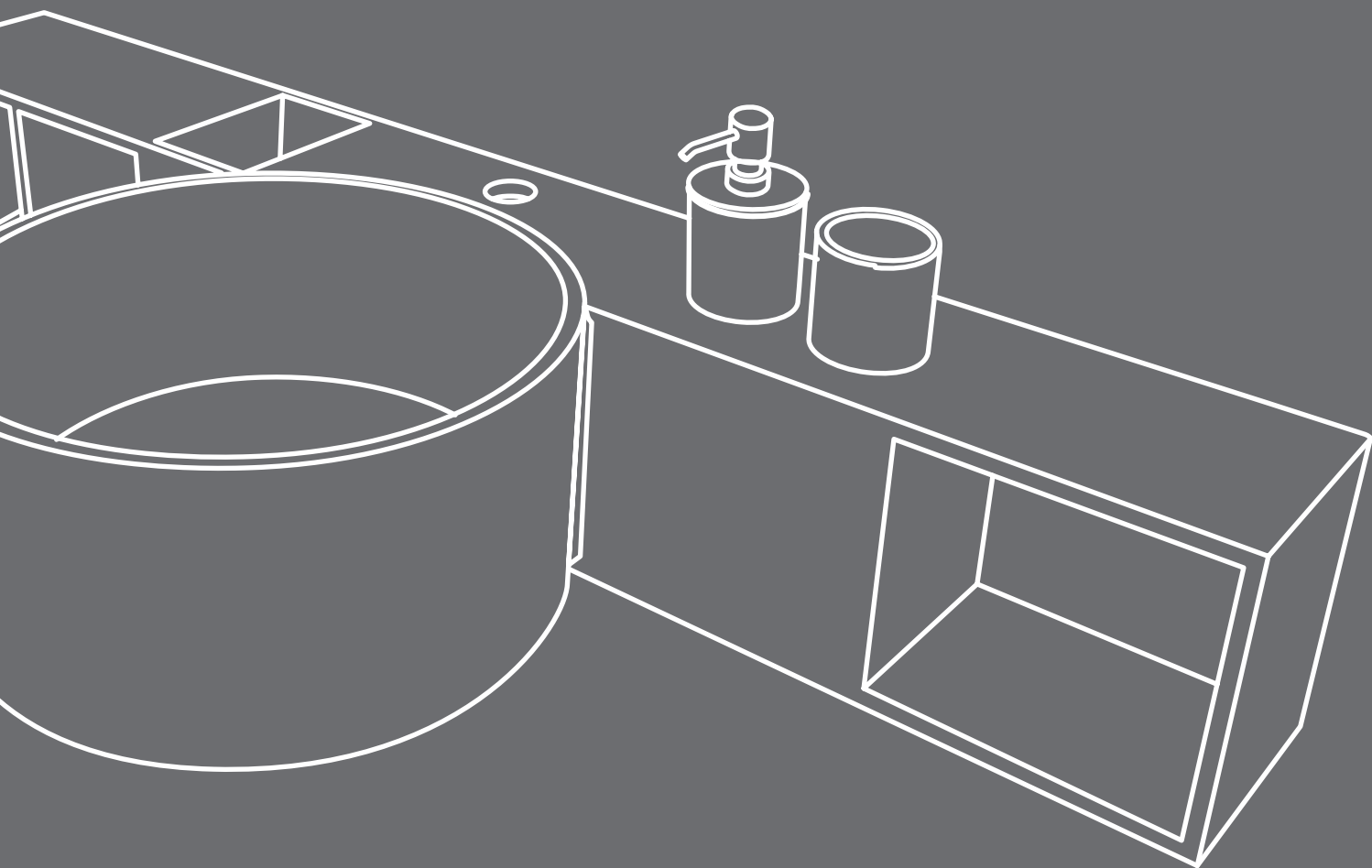

# Sella & Sella T

design **Andrea Parisio & Giuseppe Pezzano**

QR code configuratore \ configurator pg. 248

indice collezione \ collection index pg. 249 - pg. 255

modulo d'ordine \ order form pg. 251

listino prezzi \ price list pg. 252 - pg. 256





Configure the product directly online and send the order to Cielo.

Configure el producto directamente online y envíe el pedido a Cielo.  
 Configurez le produit directement en ligne et envoyez la commande à Cielo.  
 Konfigurieren Sie Ihr Produkt online und schicken Sie die Bestellung direkt an Cielo.  
 Сконфигурируйте изделие в онлайн и перешлите заказ на фабрику Cielo.

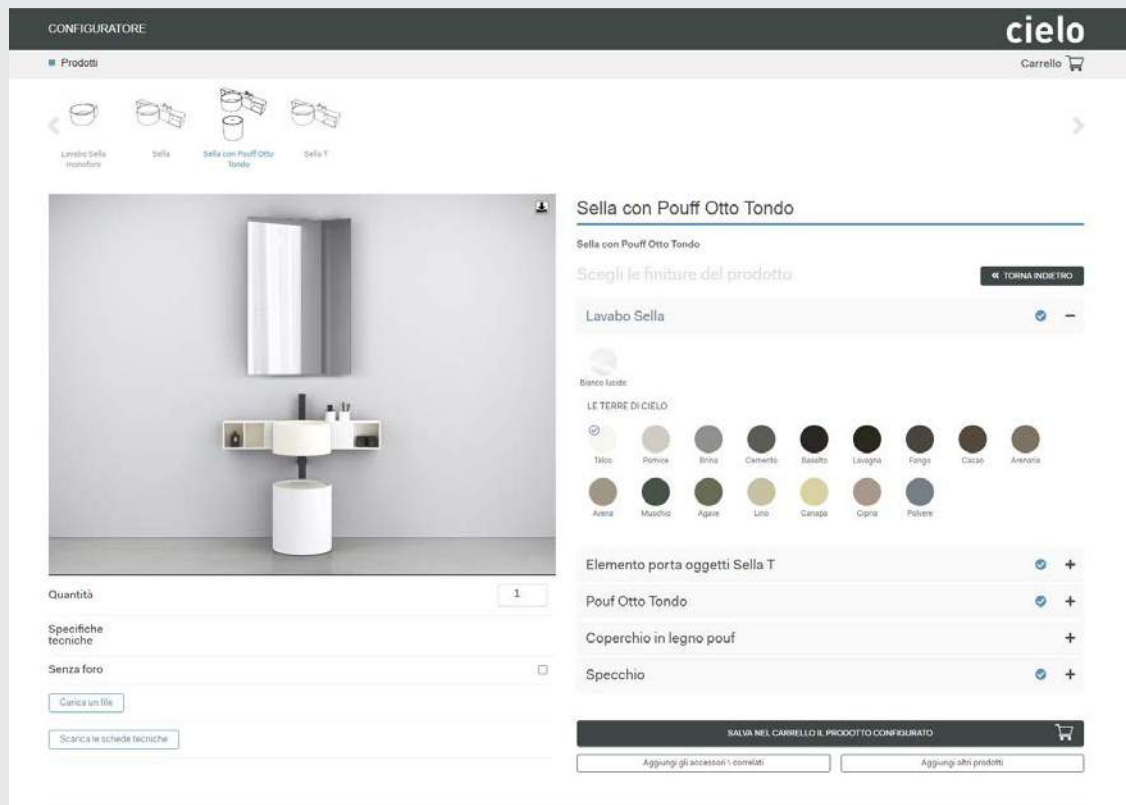

EN



go to configurator

SP



ir al configurador

FR



lien vers le configurateur

RU



Перейдите в конфигурактор

Lavabo con mobile / washbasin with cabinet

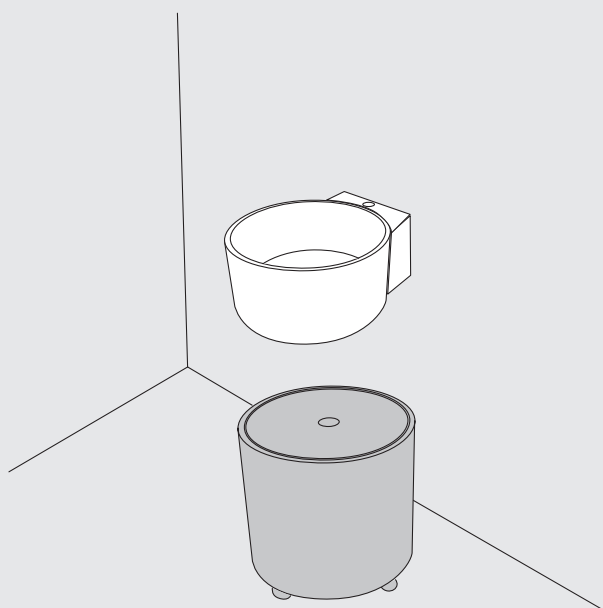
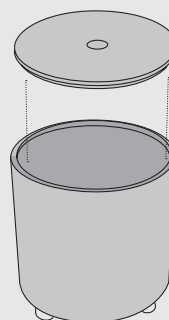
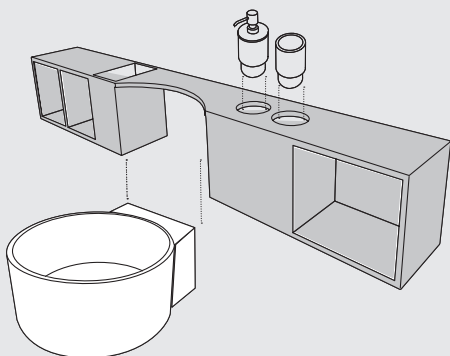

**lavabo + pouf contenitore su ruote**  
washbasin + pouf cabinet on wheels  
40 x 48 x 20 h + 0 40 x 43 h  
pag. 252

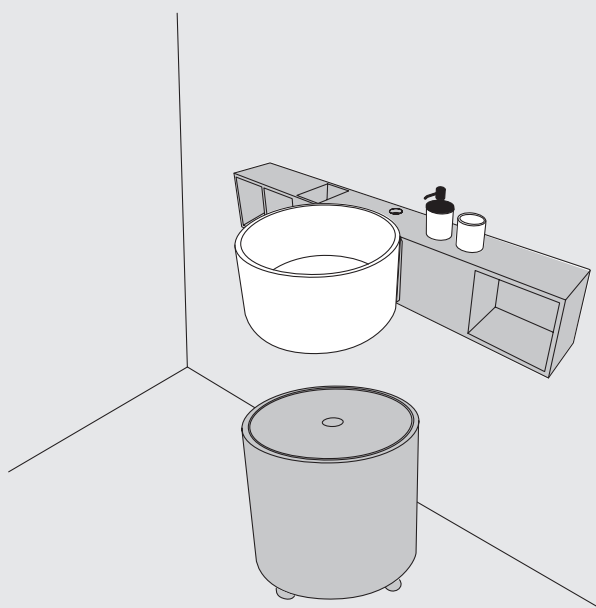

**lavabo + elemento portaoggetti sospeso + accessori + pouf**  
washbasin + wall-hung storage unit + accessories + pouf  
110 x 48 x 20 h + 0 40 x 43 h  
pag. 252



# Sella / Sella T



modelli disponibili / available models

## SELLA collection

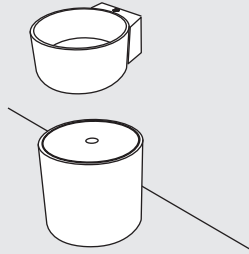

**Sella lavabo con pouf Otto**  
Sella washbasin with pouf Otto

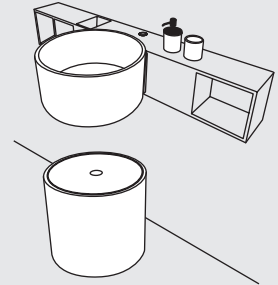

**Sella lavabo con elemento portaoggetti sospeso e pouf Otto**  
Sella washbasin with wall-hung storage unit and pouf Otto

finiture / finishes

### LAVABO IN CERAMICA / CERAMIC WASHBASIN

#### Le Terre di Cielo



#### Le Acque di Cielo

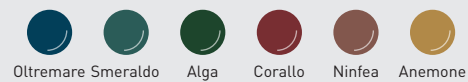

SELS / SELSF

### ELEMENTO PORTAOGGETTI IN FENIX / FENIX STORAGE UNIT

art. SEPOT / SEPOTSF

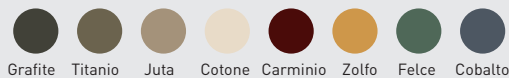

### ELEMENTO PORTAOGGETTI IN LIVINGTEC / LIVINGTEC STORAGE UNIT

art. SEPO / SEPOSF

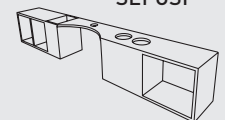
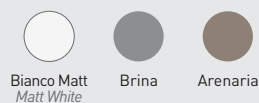

### OTTO - POUF CONTENITORE IN LIVINGTEC CON COPERCHIO IN LEGNO / POUF CABINET IN LIVINGTEC WITH WOODEN LID

#### POUF LivingTec

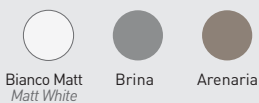

#### COPERCHIO IN LEGNO / WOODEN LID

laccature / lacquers

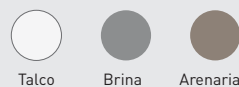

#### COPERCHIO IN LEGNO / WOODEN LID

essenze / wooden finishes

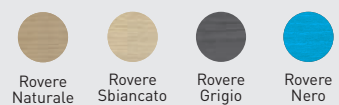

ELCTL / ELCTE

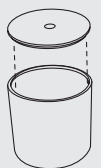

ELOT

note tecniche lavabo / washbasin technical notes

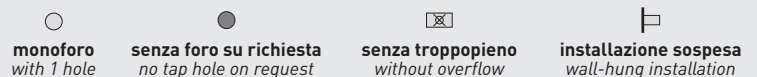

# Modulo Ordine Sella / Sellat T

Sella / Sella T Order Form

# cielo

CLIENTE/client:  ORD. REF.:

QUANTITA'/quantity:  EMAIL:

INDICARE CON UN SEGNO LE FINITURE SCELTE PER I DIVERSI COMPONENTI

INDICATE WITH A TICK, THE CHOSEN FINISHES FOR ALL THE COMPONENTS

art. SELS \ SELSSF

## FINITURE LAVABO

WASHBASIN SHELF FINISHES

Bianco/white - glossy

Le Terre di Cielo

- |                                    |                                     |
|------------------------------------|-------------------------------------|
| <input type="radio"/> TL - Talco   | <input type="radio"/> AN - Arenaria |
| <input type="radio"/> PM - Pomice  | <input type="radio"/> AV - Avena    |
| <input type="radio"/> BR - Brina   | <input type="radio"/> LN - Lino     |
| <input type="radio"/> BA - Basalto | <input type="radio"/> AG - Agave    |
| <input type="radio"/> LV - Lavagna | <input type="radio"/> MU - Muschio  |
| <input type="radio"/> CM - Cemento | <input type="radio"/> PL - Polvere  |
| <input type="radio"/> FN - Fango   | <input type="radio"/> CP - Cipria   |
| <input type="radio"/> CA - Cacao   | <input type="radio"/> CN - Canapa   |

Le Acque di Cielo

- |                                      |                                    |
|--------------------------------------|------------------------------------|
| <input type="radio"/> OL - Oltremare | <input type="radio"/> CO - Corallo |
| <input type="radio"/> SM - Smeraldo  | <input type="radio"/> NI - Ninfea  |
| <input type="radio"/> AL - Alga      | <input type="radio"/> AM - Anemone |

art. SEPO \ SEPOSF LIVINGTEC

## FINITURE ELEMENTO PORTA OGGETTI IN LIVINGTEC

STORAGE UNIT IN LIVINGTEC FINISHES

- Bianco/white - matt
- BR - Brina
- AN - Arenaria

art. SEPOT \ SEPOTSF FENIX

## FINITURE ELEMENTO PORTA OGGETTI IN FENIX

STORAGE UNIT IN FENIX FINISHES

- FGR - Grafite
- FTI - Titanio
- FJU - Juta
- FCO - Cotone
- FCA - Carminio
- FZO - Zolfo
- FFE - Felce
- FCB - Cobalto

art. ELOT YES  NO

## FINITURE POUF CONTENITORE IN LIVINGTEC

POUF CABINET IN LIVINGTEC FINISHES

- Bianco/white - matt
- BR - Brina
- AN - Arenaria

art. ELCTL \ art. ELCTE

## FINITURE COPERCHIO IN LEGNO

WOODEN LID FINISHES

laccature/laquerings

- Bianco/white - matt
- BR - Brina
- AN - Arenaria

essenze legno/wood essences

- RO - Rovere Nero
- RG - Rovere Grigio
- RS - Rovere Sbiancato
- RN - Rovere Naturale

**N.B. Il lavabo è monoforo, su richiesta può essere prodotto senza foro**

*N.B. The washbasin has 1 hole; may be made without holes upon request*

DATA

DATE

FIRMA DEL CLIENTE

SIGNATURE

ATTENZIONE:

La rappresentazione delle finiture è puramente indicativa. Verificare le finiture con le relative cartelle.

Ogni oggetto possiede la peculiarità di essere elaborato secondo principi puramente tradizionali, in modo da garantirne l'assoluta originalità ed unicità. Le eventuali piccole variazioni di colore, tono o venature fra gli articoli sono da considerarsi pregi e non difetti, in quanto garanzia della fattura manuale del prodotto, che fa di ogni oggetto Cielo un pezzo unico ed esclusivo, lontano dall'omologazione industriale. In fase d'ordine si intendono, pertanto, accettate tali tolleranze che non possono dare adito a contestazioni di alcun genere.















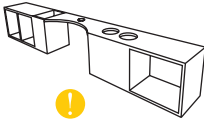



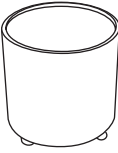





Verificare sempre le disponibilità e i tempi di consegna con il commerciale.

ATTENTION:

The representation of the finishes is merely indicative. Please choose the finishes using the folders.





















Every item possesses that particular feature of being processed according to purely traditional principles that guarantee its absolute originality and uniqueness. The small variations in colour, hues or streaks on the items are to be considered as qualities and not defects, since they warranty the handcrafted processing which makes each Cielo item a unique and exclusive piece that cannot be compared to industrial standardization. When making the order, the client implicitly accepts those various features that may give rise to claims of any sort.

Always check the availability and delivery time with the commercial department.

	<b>Size (cm)</b> Medidas Dimensions Maße Размеры	<b>Product code</b> Artículo Article Artikel Артикул	<b>Net weight(Kg)</b> Peso neto Poids net Reingewicht вес нетто	<b>Finishes</b> Acabados Finitions Farbe Отделки	<b>Euro</b> Евро
 <p><b>Ceramic washbasin with 1 hole</b>                      Lavabo de cerámica monoagujero                      Lavabo en céramique avec un trou                      Waschbecken aus Keramik mit 1 Hahnloch                      Керамическая раковина на одно отверстие</p>	110 x 48 x h20	SELS(X)*  SELSSF(X)* no tap hole sin agujero sans orifice ohne Loch без отверстия	14,00	<ul style="list-style-type: none"> <li> <b>Gloss White</b></li> <li> <b>Le Terre di Cielo</b></li> <li> <b>Le Acque di Cielo</b></li> </ul>	561,00 813,00 813,00
 <p><b>Storage unit in LivingTec</b>                      Elemento portaobjetos en LivingTec \ Accessoire porte objet en living-tec \ Zubehörablage aus LivingTec \ Полочки из материала Living Tec</p>	110 x 15 x 19 h	SEPO(X)*  SEPOSF(X)* no tap hole sin agujero sans orifice ohne Loch без отверстия	10,00	<ul style="list-style-type: none"> <li> <b>Matt White</b></li> <li> <b>Brina</b></li> <li> <b>Arenaria</b></li> </ul>	978,00 1468,00 1468,00
 <p><b>Otto Tondo: round pouf cabinet in LivingTec on 4 wheels</b>                      pouf contenedor in Livingtec con 4 ruedas, con tapa en madera \ tabouret conteneur en living-tec à 4 roue, couvercle en bois \ Puff mit Stauraum aus LivingTec auf 4 Rollen, mit Deckel aus Holz \ Пуф круглый из материала Livingtec на 4-х колесиках, с крышкой деревянной</p>	Ø 40 x 43 h	ELOT(X)*	15,50	<ul style="list-style-type: none"> <li> <b>Matt White</b></li> <li> <b>Brina</b></li> <li> <b>Arenaria</b></li> </ul>	764,00 1146,00 1146,00
 <p><b>Lacquered wooden lid</b>                      Tapa en madera lacada \ miroir en bois laqué \ Deckel aus lackiertem Holz \ Крышка крашенная деревянная</p>	Ø 36 X 2 h	ELCTL(X)*	1,40	<ul style="list-style-type: none"> <li> <b>Talco</b></li> <li> <b>Brina</b></li> <li> <b>Arenaria</b></li> </ul>	183,00 183,00 183,00
 <p><b>Lid in wooden finish</b>                      Tapa en madera \ couvercle en bois \ Deckel aus Holz \ Крышка шпонирующая</p>	Ø 36 X 2 h	ELCTE(X)*	1,40	<ul style="list-style-type: none"> <li> <b>EsSENze Rovere *</b></li> </ul>	242,00
 <p><b>Cup in LivingTec</b>                      Vaso en LivingTec \ Verre en LivingTec                      Glas aus LivingTec \ Стаканчик LivingTec</p>	Ø7 x h11	ACBI	0,30	<ul style="list-style-type: none"> <li> <b>Matt White</b></li> </ul>	73,00
 <p><b>Dispenser in LivingTec (white glass in LivingTec with metal dispenser)</b>                      Dosificador en LivingTec (dosificador Blanco con dispensador de metal) \ Distributeur en LivingTec (Verre Blanc avec distributeur de métal) \ Spender aus LivingTec (Glas Weiß mit Metallspender) \ дозатор LivingTec (стаканчик белый, раздатчик металла)</p>	Ø7 x h15	ACDI	0,60	metal part <ul style="list-style-type: none"> <li> <b>NM - Matt Black</b></li> <li> <b>BZ - Brushed Bronze</b></li> <li> <b>CR - Chrome</b></li> <li> <b>CM - Cemento</b></li> </ul>	213,00 228,00 228,00 213,00

**mandatory with art. SELS\SELSSF**  
 obligatorio con el artículo SELS\SELSSF  
 obligatoire avec l'article SELS\SELSSF  
 obligatorisch mit SELS\SELSSF  
 обязательно с SELS\SELSSF

**mandatory with art. SEPO**  
 obligatorio con el artículo SEPO  
 obligatoire avec l'article SEPO  
 obligatorisch mit SEPO  
 обязательно с SEPO

	Product code Artículo Article Artikel Артикул	Net weight <sup>(kg)</sup> Peso neto Poids net Reingewicht вес нетто	Finishes Acabados Finitions Farbe Отделки	Euro Евро
 <p><b>Universal click/clack drain in CHROME with ceramic lid</b> Válvula universal click/clack Cromado con tapa en cerámica Bonde universelle clic/clac Chromé avec clapet en céramique Universal-Ablaufgarnitur Click-Clack Chrom mit Keramikstopfen Универсальный донный клапан click/clack хром с керамической крышкой</p>	PIL01(X)*	0,40	 <b>Gloss White</b>	<b>95,00</b>
			 <b>Le Terre di Cielo</b>	<b>139,00</b>
 <p><b>Universal click/clack drain in BLACK MATT finish with ceramic lid</b> Válvula universal click/clack Negro Matt con tapa en cerámica Bonde universelle clic/clac Noir Mat avec clapet en céramique Universal-Ablaufgarnitur Click-Clack Matt Schwarz mit Keramikstopfen Универсальный донный клапан click/clack черный матовый с керамической крышкой</p>	PIL01NM(X)*	0,40	 <b>Gloss White</b>	<b>120,00</b>
			 <b>Le Terre di Cielo</b>	<b>169,00</b>
 <p><b>Universal click/clack drain in CEMENTO finish with ceramic lid</b> Válvula universal click/clack Cemento con tapa en cerámica Bonde universelle clic/clac Cemento avec clapet en céramique Universal-Ablaufgarnitur Click-Clack Cement mit Keramikstopfen Универсальный донный Cemento click/clack с керамической крышкой</p>	PIL01CM(X)*	0,40	 <b>Gloss White</b>	<b>120,00</b>
			 <b>Le Terre di Cielo</b>	<b>169,00</b>
 <p><b>Universal click/clack drain in BRONZE with ceramic lid</b> Válvula universal click/clack Bronce con tapa en cerámica Bonde universelle clic/clac Bronze avec clapet en céramique Universal-Ablaufgarnitur Click-Clack Bronze mit Keramikstopfen Универсальный донный клапан click/clack бронза с керамической крышкой</p>	PIL01BR(X)*	0,40	 <b>Gloss White</b>	<b>135,00</b>
			 <b>Le Terre di Cielo</b>	<b>182,00</b>
 <p><b>CHROMED siphon</b> Sifone Cromado \ Siphon Chromé \ Siphon Verchromt \ сифон Chrome</p>	SISP	0,93	 <b>Chrome</b>	<b>133,00</b>
 <p><b>MATT BLACK siphon</b> Sifone Negro Mate \ Siphon Noir Mat \ Siphon Schwarz Matt \ Сифон Черный матовый</p>	SIFN	0,93	 <b>Matt Black</b>	<b>194,00</b>
 <p><b>CEMENTO siphon</b> Sifone Cemento \ Siphon Cemento \ Siphon Cemento \ сифон Cemento</p>	SIFCM	0,93	 <b>Cemento</b>	<b>194,00</b>
 <p><b>BRONZE siphon</b> Sifone Bronce \ Siphon Bronze \ Siphon Bronze \ бронза сифон</p>	SIFBR	0,93	 <b>Bronze</b>	<b>220,00</b>

**Terre di Cielo available for ceramic washbasin /**

Terre di Cielo disponibles para lavabo de cerámica | Terre di Cielo disponibles pour les lavabos en céramique | Für Waschbecken erhältliche Terre di Cielo | Отделки Terre di Cielo доступны для раковин и керамических столешниц

 TL - Talco	 PM - Pomice	 BR - Brina	 BA - Basalto	 LV - Lavagna	 CM - Cemento
 FN - Fango	 CA - Cacao	 AN - Arenaria	 AV - Avena	 LN - Lino	 AG - Agave
 MU - Muschio	 PL - Polvere	 CP - Cipria	 CN - Canapa		

**Acque di Cielo available for ceramic washbasin /**

Acque di Cielo disponibles para lavabo de cerámica | Acque di Cielo disponibles pour les lavabos en céramique | Für Waschbecken erhältliche Acque di Cielo | Отделки Acque di Cielo доступны для раковин и керамических столешниц



 OL - Oltremare	 SM - Smeraldo	 AL - Alga
 CO - Corallo	 NI - Ninfea	 AM - Anemone

**\* Essenze Rovere**

 RS - Rovere Sbiancato	 RN - Rovere Naturale	 RG - Rovere Grigio	 R0 - Rovere Nero
---	--	--	--

**Technical symbols legend /**

Simbolos técnicos clave | Légende symboles techniques | Technische Zeichenerklärung | Перечень технических символов

 <b>with 1 hole</b> con 1 agujero avec un trou mit 1-Loch r одно отверстие	 <b>no tap hole on request</b> sin agujero, solo a petición sans orifice sur demande auf Anfrage ohne Loch без отверстия под смеситель по запросу	 <b>without overflow</b> sin rebosadero sans trop-plein ohne Überlauf без слива-перелива	 <b>wall-hung installation</b> instalación suspendida installation suspendue wandhängende Montage подвесная установка	 <b>with fixing parts</b> fijaciones incluidas fixations incluses inklusive Befestigungen в комплекте с крепежами
---	--	---	--	--





Lavabo con mobile / washbasin with cabinet

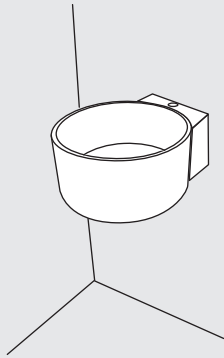

**lavabo**  
washbasin  
40 x 48 x h20  
pag. 256

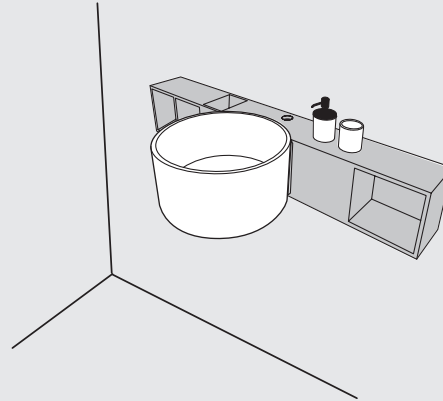

**lavabo + elemento porta oggetti in Fenix**  
washbasin + Fenix storage unit  
110 x 48 x h 20  
pag. 256

**Washbasins finishes**

Acabados de Lavabos \ Finitions des Lavabos \  
Waschbecken Farbe \ Отделки Раковина

○ Gloss White

**Le Terre di Cielo**

- |                |                 |
|----------------|-----------------|
| ○ TL - Talco   | ● AN - Arenaria |
| ○ PM - Pomice  | ● AV - Avena    |
| ● BR - Brina   | ● MU - Muschio  |
| ● CM - Cemento | ● AG - Agave    |
| ● BA - Basalto | ● LN - Lino     |
| ● LV - Lavagna | ● CN - Canapa   |
| ● FN - Fango   | ● CP - Cipria   |
| ● CA - Cacao   | ● PL - Polvere  |

**Le Acque di Cielo**

- OL - Oltremare
- SM - Smeraldo
- AL - Alga
- CO - Corallo
- NI - Ninfea
- AM - Anemone

**Fenix storage unit finishes**

Acabado revestimiento Theo / Finitions  
Revêtement Theo / Ausführung Verkleidung  
Theo / Отделки для Theo

**Fenix**

- FGR - Grafite
- FTI - Titanio
- FJU - Juta
- FCO - Cotone
- FCA - Carminio
- FZO - Zolfo
- FFE - Felce
- FCB - Cobalto

The possible variations of the colour cannot be considered as defect, but as a guarantee of the completely artisan manufacturing of this unique and high quality product.





Las variaciones de colores no se consideran un defecto sino una garantía de una elaboración manual y artesanal en un producto único y de calidad.

Les éventuelles variations de couleur ne peuvent être considérées comme des défauts, elles témoignent en revanche d'une méthode de travail totalement manuelle et artisanale employée pour obtenir un produit fini unique et de qualité.

Eventuelle Farbvariationen sind nicht als Mangel anzusehen, sondern als Garantie für die komplett handwerkliche Anfertigung eines einzigartigen und hochqualitativen Produkts.



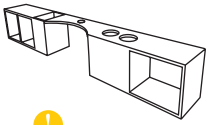
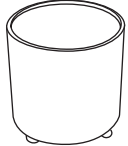
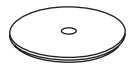
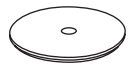

















Возможные вариации цвета не могут считаться дефектом, а являются подтверждением ручной работы, гарантией качества и уникальности изделия.



	<b>Size (cm)</b> Medidas Dimensions Maße Размеры	<b>Product code</b> Artículo Article Artikel Артикул	<b>Net weight (Kg)</b> Peso neto Poids net Reingewicht вес нетто	<b>Finishes</b> Acabados Finitions Farbe Отделка	<b>Euro</b> Евро
 <p><b>Ceramic washbasin with 1 hole</b>                      Lavabo de cerámica monoagujero                      Lavabo en céramique avec un trou                      Waschbecken aus Keramik mit 1 Hahnloch                      Керамическая раковина на одно отверстие</p>	40 x 48 x h 20	SELS(X)* SELSSF(X)* no tap hole sin agujero sans orifice ohne Loch без отверстия	14,00	<ul style="list-style-type: none"> <li><span style="display: inline-block; width: 10px; height: 10px; background-color: white; border: 1px solid black; border-radius: 50%; margin-right: 5px;"></span> Gloss White</li> <li><span style="display: inline-block; width: 10px; height: 10px; background-color: #8B4513; border: 1px solid black; border-radius: 50%; margin-right: 5px;"></span> Le Terre di Cielo</li> <li><span style="display: inline-block; width: 10px; height: 10px; background-color: #008080; border: 1px solid black; border-radius: 50%; margin-right: 5px;"></span> Le Acque di Cielo</li> </ul>	561,00 813,00 813,00
 <p><b>Storage unit in Fenix</b>                      Elemento portaobjetos en Fenix \ Accessoire                      porte objet en Fenix \ Zubehörlage aus Fenix \                      Полочки из материала Fenix</p>	110 x 15 x 19 h	SEPOT(X)* SEPOTSF(X)* no tap hole sin agujero sans orifice ohne Loch без отверстия	7,30	<ul style="list-style-type: none"> <li><span style="display: inline-block; width: 10px; height: 10px; background-color: #333; border: 1px solid black; border-radius: 50%; margin-right: 5px;"></span> *X = FGR - Grafite</li> <li><span style="display: inline-block; width: 10px; height: 10px; background-color: #666; border: 1px solid black; border-radius: 50%; margin-right: 5px;"></span> *X = FTI - Titanio</li> <li><span style="display: inline-block; width: 10px; height: 10px; background-color: #999; border: 1px solid black; border-radius: 50%; margin-right: 5px;"></span> *X = FJU - Juta</li> <li><span style="display: inline-block; width: 10px; height: 10px; background-color: #ccc; border: 1px solid black; border-radius: 50%; margin-right: 5px;"></span> *X = FCO - Cotone</li> <li><span style="display: inline-block; width: 10px; height: 10px; background-color: #990000; border: 1px solid black; border-radius: 50%; margin-right: 5px;"></span> *X = FCA - Carminio</li> <li><span style="display: inline-block; width: 10px; height: 10px; background-color: #FFA500; border: 1px solid black; border-radius: 50%; margin-right: 5px;"></span> *X = FZO - Zolfo</li> <li><span style="display: inline-block; width: 10px; height: 10px; background-color: #3CB371; border: 1px solid black; border-radius: 50%; margin-right: 5px;"></span> *X = FFE - Felce</li> <li><span style="display: inline-block; width: 10px; height: 10px; background-color: #4682B4; border: 1px solid black; border-radius: 50%; margin-right: 5px;"></span> *X = FCB - Cobalto</li> </ul>	2391,00
 <p><b>Otto Tondo: round pouf cabinet in LivingTec on 4 wheels</b>                      pouf contenedor in Livingtec con 4 ruedas, con tapa                      en madera \ tabouret conteneur en living-tec à 4                      roue, couvercle en bois \ Puff mit Stauraum aus                      LivingTec auf 4 Rollen, mit Deckel aus Holz \ Пуф                      круглый из материала Livingtec на 4-х колесиках,                      с крышкой деревянной</p>	Ø 40 x 43 h	ELOT(X)*	15,50	<ul style="list-style-type: none"> <li><span style="display: inline-block; width: 10px; height: 10px; background-color: white; border: 1px solid black; border-radius: 50%; margin-right: 5px;"></span> Matt White</li> <li><span style="display: inline-block; width: 10px; height: 10px; background-color: #808080; border: 1px solid black; border-radius: 50%; margin-right: 5px;"></span> Brina</li> <li><span style="display: inline-block; width: 10px; height: 10px; background-color: #A08060; border: 1px solid black; border-radius: 50%; margin-right: 5px;"></span> Arenaria</li> </ul>	764,00 1146,00 1146,00
 <p><b>Lacquered wooden lid</b>                      Tapa en madera lacada \ miroir en bois laqué \                      Deckel aus lackiertem Holz \ Крышка крашенная                      деревянная</p>	Ø 36 X 2 h	ELCTL(X)*	1,40	<ul style="list-style-type: none"> <li><span style="display: inline-block; width: 10px; height: 10px; background-color: white; border: 1px solid black; border-radius: 50%; margin-right: 5px;"></span> Talco</li> <li><span style="display: inline-block; width: 10px; height: 10px; background-color: #808080; border: 1px solid black; border-radius: 50%; margin-right: 5px;"></span> Brina</li> <li><span style="display: inline-block; width: 10px; height: 10px; background-color: #A08060; border: 1px solid black; border-radius: 50%; margin-right: 5px;"></span> Arenaria</li> </ul>	183,00 183,00 183,00
 <p><b>Lid in wooden finish</b>                      Tapa en madera \ couvercle en bois \ Deckel aus                      Holz \ Крышка шпонирующая</p>	Ø 36 X 2 h	ELCTE(X)*	1,40	<ul style="list-style-type: none"> <li><span style="display: inline-block; width: 10px; height: 10px; background-color: #C08040; border: 1px solid black; border-radius: 50%; margin-right: 5px;"></span> Essenze Rovere *</li> </ul>	242,00
 <p><b>Cup in LivingTec</b>                      Vaso en LivingTec \ Verre en LivingTec                      Glas aus LivingTec \ Стаканчик LivingTec</p>	Ø7 x h11	ACBI	0,30	<ul style="list-style-type: none"> <li><span style="display: inline-block; width: 10px; height: 10px; background-color: white; border: 1px solid black; border-radius: 50%; margin-right: 5px;"></span> Matt White</li> </ul>	73,00
 <p><b>Dispenser in LivingTec (white glass in LivingTec with metal dispenser)</b>                      Dosificador en LivingTec (dosificador Blanco con                      dispensador de metal) \ Distributeur en LivingTec                      (Verre Blanc avec distributeur de métal) \ Spender                      aus LivingTec (Glas Weiß mit Metallspender) \                      дозатор LivingTec (стаканчик белый, раздатчик                      металла)</p>	Ø7 x h15	ACDI	0,60	metal part <ul style="list-style-type: none"> <li><span style="display: inline-block; width: 10px; height: 10px; background-color: black; border: 1px solid black; border-radius: 50%; margin-right: 5px;"></span> NM - Matt Black</li> <li><span style="display: inline-block; width: 10px; height: 10px; background-color: #8B4513; border: 1px solid black; border-radius: 50%; margin-right: 5px;"></span> BZ - Brushed Bronze</li> <li><span style="display: inline-block; width: 10px; height: 10px; background-color: #808080; border: 1px solid black; border-radius: 50%; margin-right: 5px;"></span> CR - Chrome</li> <li><span style="display: inline-block; width: 10px; height: 10px; background-color: #333; border: 1px solid black; border-radius: 50%; margin-right: 5px;"></span> CM - Cemento</li> </ul>	213,00 228,00 228,00 213,00

**mandatory with art. SELS\SELSSF**  
 obligatorio con el artículo SELS\SELSSF  
 obligatoire avec l'article SELS\SELSSF  
 obligatorisch mit SELS\SELSSF  
 обязательно с SELS\SELSSF

**mandatory with art. SEPO**  
 obligatorio con el artículo SEPO  
 obligatoire avec l'article SEPO  
 obligatorisch mit SEPO  
 обязательно с SEPO

	<b>Product code</b> Artículo Article Artikel Артикул	<b>Net weight</b> (Kg) Peso neto Poids net Reingewicht вес нетто	<b>Finishes</b> Acabados Finitions Farbe Отделки	<b>Euro</b> Евро
 <p><b>Universal click/clack drain in CHROME with ceramic lid</b> Válvula universal click/clack Cromado con tapa en cerámica Bonde universelle clic/clac Chromé avec clapet en céramique Universal-Abflussgarnitur Click-Clack Chrom mit Keramikstopfen Универсальный донный клапан click/clack хром с керамической крышкой</p>	PIL01(X)*	0,40	 <b>Gloss White</b>	<b>95,00</b>
			 <b>Le Terre di Cielo</b>	<b>139,00</b>
 <p><b>Universal click/clack drain in BLACK MATT finish with ceramic lid</b> Válvula universal click/clack Negro Matt con tapa en cerámica Bonde universelle clic/clac Noir Mat avec clapet en céramique Universal-Abflussgarnitur Click-Clack Matt Schwarz mit Keramikstopfen Универсальный донный клапан click/clack черный матовый с керамической крышкой</p>	PIL01NM(X)*	0,40	 <b>Gloss White</b>	<b>120,00</b>
			 <b>Le Terre di Cielo</b>	<b>169,00</b>
 <p><b>Universal click/clack drain in CEMENTO finish with ceramic lid</b> Válvula universal click/clack Cemento con tapa en cerámica Bonde universelle clic/clac Cemento avec clapet en céramique Universal-Abflussgarnitur Click-Clack Cement mit Keramikstopfen Универсальный донный Cemento click/clack с керамической крышкой</p>	PIL01CM(X)*	0,40	 <b>Gloss White</b>	<b>120,00</b>
			 <b>Le Terre di Cielo</b>	<b>169,00</b>
 <p><b>Universal click/clack drain in BRONZE with ceramic lid</b> Válvula universal click/clack Bronce con tapa en cerámica Bonde universelle clic/clac Bronze avec clapet en céramique Universal-Abflussgarnitur Click-Clack Bronze mit Keramikstopfen Универсальный донный клапан click/clack бронза с керамической крышкой</p>	PIL01BR(X)*	0,40	 <b>Gloss White</b>	<b>135,00</b>
			 <b>Le Terre di Cielo</b>	<b>182,00</b>
 <p><b>CHROMED siphon</b> Sifone Cromado \ Siphon Chromé \ Siphon Verchromt \ сифон Chrome</p>	SISP	0,93	 <b>Chrome</b>	<b>133,00</b>
 <p><b>MATT BLACK siphon</b> Sifone Negro Mate \ Siphon Noir Mat \ Siphon Schwarz Matt \ Сифон Черный матовый</p>	SIFN	0,93	 <b>Matt Black</b>	<b>194,00</b>
 <p><b>CEMENTO siphon</b> Sifone Cemento \ Siphon Cemento \ Siphon Cemento \ сифон Cemento</p>	SIFCM	0,93	 <b>Cemento</b>	<b>194,00</b>
 <p><b>BRONZE siphon</b> Sifone Bronce \ Siphon Bronze \ Siphon Bronze \ бронза сифон</p>	SIFBR	0,93	 <b>Bronze</b>	<b>220,00</b>

**Terre di Cielo available for ceramic washbasin /**  
Terre di Cielo disponibles para lavabo de cerámica / Terre di Cielo disponibles pour les lavabos en céramique / Für Waschbecken erhältliche Terre di Cielo / Отделка Terre di Cielo доступны для раковин и керамических столешниц



**Acque di Cielo available for ceramic washbasin /**  
Acque di Cielo disponibles para lavabo de cerámica / Acque di Cielo disponibles pour les lavabos en céramique / Für Waschbecken erhältliche Acque di Cielo / Отделка Acque di Cielo доступны для раковин и керамических столешниц



**Technical symbols legend /**  
Símbolos técnicos clave / Légende symboles techniques / Technische Zeichenerklärung / Перечень технических символов

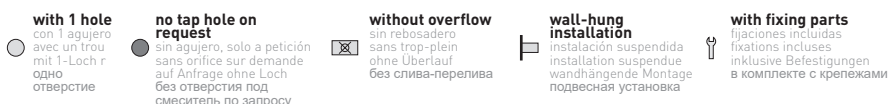

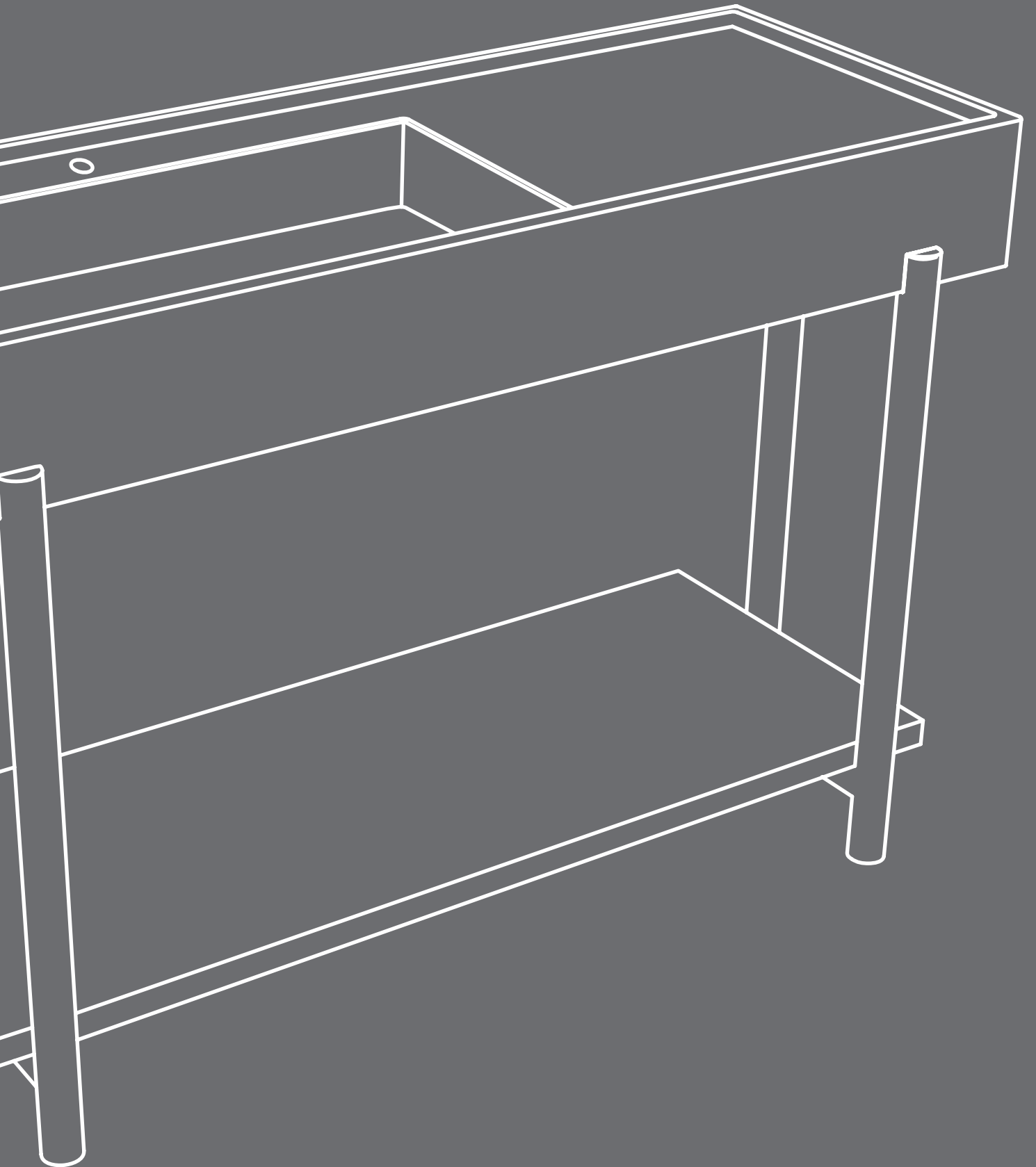

# Plinio

design **Andrea Parisio & Giuseppe Pezzano**

QR code configuratore \ configurator pg. 262

indice collezione \ collection index pg. 263

moduli d'ordine \ order form pg. 265 - 267

listino prezzi \ price list pg. 268 - 269









Configure the product directly online and send the order to Cielo.

Configure el producto directamente online y envíe el pedido a Cielo.  
 Configurez le produit directement en ligne et envoyez la commande à Cielo.  
 Konfigurieren Sie Ihr Produkt online und schicken Sie die Bestellung direkt an Cielo.  
 Сконфигурируйте изделие в онлайн и перешлите заказ на фабрику Cielo.

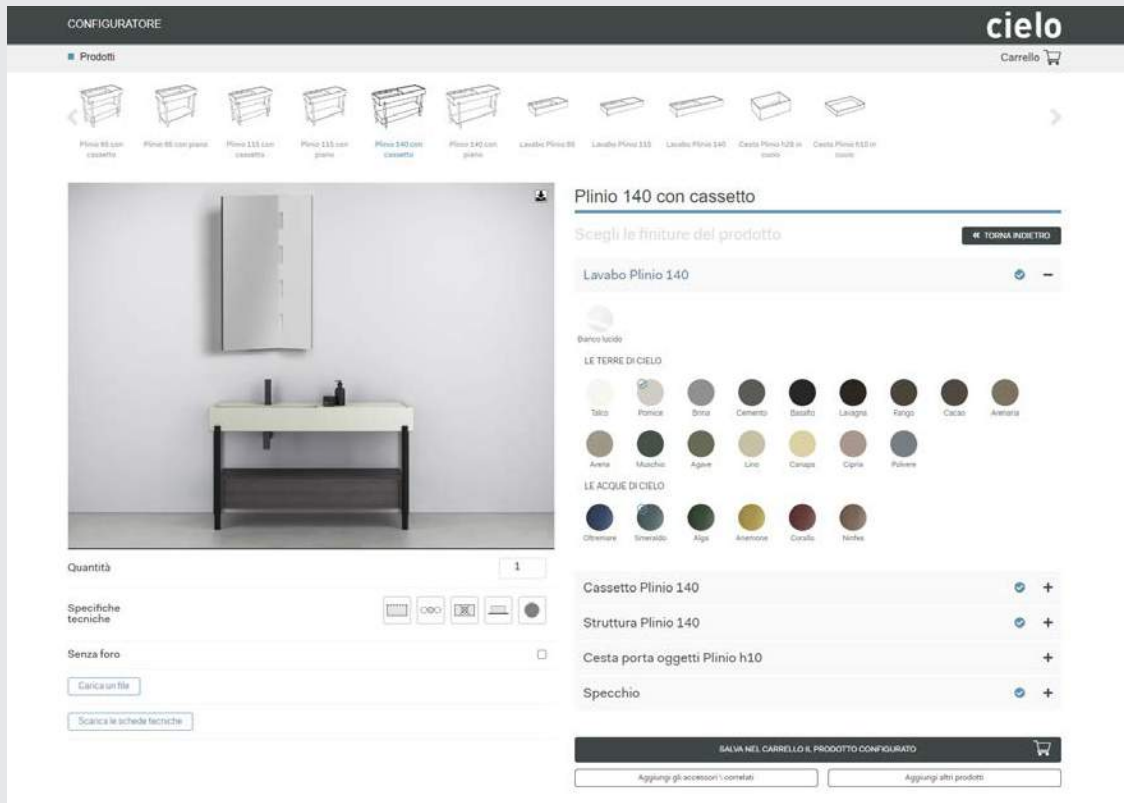

EN

SP

FR

RU



go to  
configurator



ir al  
configurador

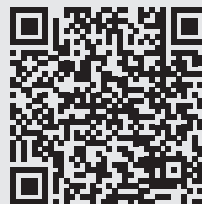

lien vers le  
configurateur



Перейдите в  
конфигуратор

## Lavabo con mobile / washbasin with cabinet

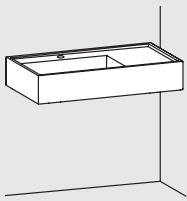

### PLINIO 85

**lavabo 85, installazione sospesa**  
washbasin 85, wall-hung  
installation  
85 x 46 x 16 h  
pag. 268

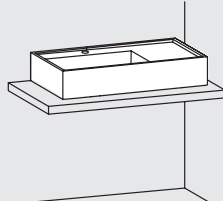

**lavabo 85, installazione da piano**  
washbasin 85, on top installation  
85 x 46 x 16 h  
pag. 268

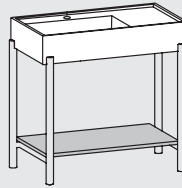

**lavabo 85 + piano + struttura**  
washbasin 85 + shelf + framework  
85 x 46 x 83 h  
pag. 268

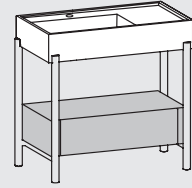

**lavabo 85 + cassetto + struttura**  
washbasin 85 + drawer + framework  
85 x 46 x 83 h  
pag. 268

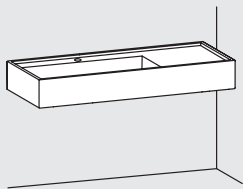

### PLINIO 115

**lavabo 115, installazione sospesa**  
washbasin 115, wall-hung  
installation  
115 x 46 x 16 h  
pag. 268

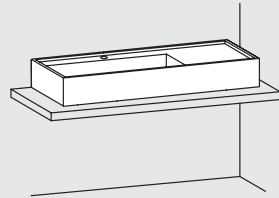

**lavabo 115, installazione da piano**  
washbasin 115, on top installation  
115 x 46 x 16 h  
pag. 268

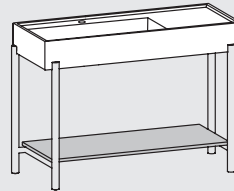

**lavabo 115 + piano + struttura**  
washbasin 115 + shelf + framework  
115 x 46 x 83 h  
pag. 268

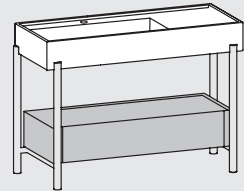

**lavabo 115 + cassetto + struttura**  
washbasin 115 + drawer +  
framework  
115 x 46 x 83 h  
pag. 268

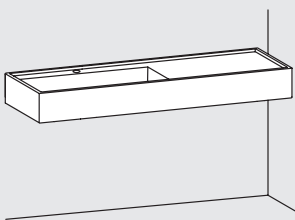

### PLINIO 140

**lavabo 140, installazione sospesa**  
washbasin 140, wall-hung  
installation  
140 x 46 x 16 h  
pag. 268

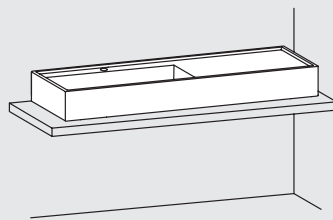

**lavabo 140, installazione da piano**  
washbasin 140, on top installation  
140 x 46 x 16 h  
pag. 268

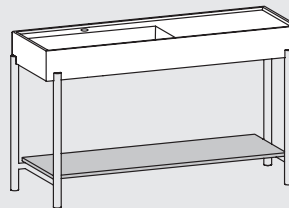

**lavabo 140 + piano + struttura**  
washbasin 140 + shelf + framework  
140 x 46 x 83 h  
pag. 268

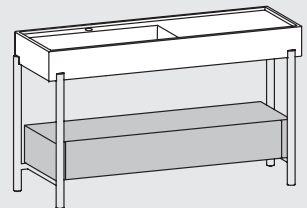

**lavabo 140 + cassetto + struttura**  
washbasin 140 + drawer +  
framework  
140 x 46 x 83 h  
pag. 268

## Accessories \ baskets

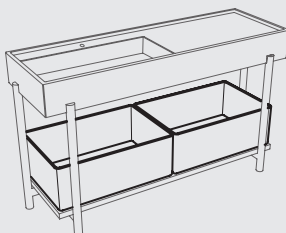

**ceste h 28 cm \ baskets h 28 cm**  
pag. 269

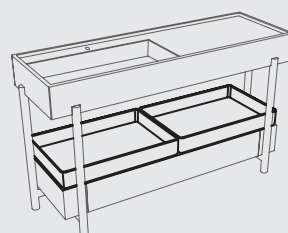

**ceste h10 cm \ baskets h10 cm**  
pag. 269

modelli disponibili / available models

## PLINIO collection

cm 140 x 46 x h83

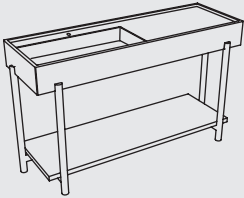

**Plinio mobile  
con piano**  
Plinio cabinet  
with shelf

cm 115 x 46 x h83

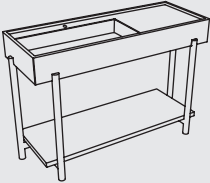

cm 85 x 46 x h83



finiture / finishes

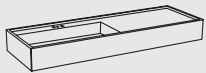

PNLA\  
PNLA115\  
PNLA85

### LAVABO IN CERAMICA / CERAMIC WASHBASIN

#### Le Terre di Cielo

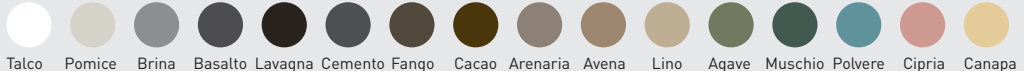

Talco Pomice Brina Basalto Lavagna Cemento Fango Cacao Arenaria Avena Lino Agave Muschio Polvere Cipria Canapa



Bianco Lucido  
Glass White

#### Le Acque di Cielo



Oltremare Smeraldo Alga Corallo Ninfea Anemone

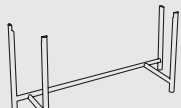

PNST\  
PNST115\  
PNST85

### STRUTTURA IN ACCIAIO / STEEL FRAMEWORK

#### verniciature / coatings

#### Le Acque di Cielo



Nero Matt Cemento Oltremare Smeraldo Alga Corallo Ninfea Anemone

Matt Black

### STRUTTURA IN LEGNO / WOODEN FRAMEWORK

#### essenze / wooden finishes



Rovere Naturale Rovere Sbiancato Rovere Grigio Rovere Nero



PNPIL\  
PNPIE\  
PNP115L\  
PNP115E\  
PNP185L\  
PNP185E

### PIANO IN LEGNO / WOODEN SHELF

#### laccature / lacquers

#### Le Terre di Cielo



Talco Pomice Brina Arenaria Avena Cemento Basalto Muschio

#### essenze / wooden finishes

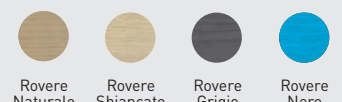

Rovere Naturale Rovere Sbiancato Rovere Grigio Rovere Nero



PNSC

### CESTE IN CUOIO / BASKETS IN LEATHER



Nero Matt Cuoio Bianco Matt

Matt Black

Matt White

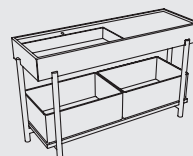

note tecniche lavabo / washbasin technical notes



monoforo predisposto 3 fori  
with 1 hole prepared 3 holes



senza foro su richiesta  
no tap hole on request



senza troppopieno  
without overflow



con un lato non smaltato  
one side is unglazed



installazione da appoggio  
on top installation



installazione sospesa  
wall-hung installation



ATTENZIONE: obbligo struttura + lavabo + cassetto/piano  
PLEASE NOTE: mandatory framework + washbasin + drawer/shelf

# Modulo Ordine Plinio con piano

Plinio with shelf Order Form

# cielo

CLIENTE/client:  ORD. REF.:

QUANTITA'/quantity:  EMAIL:

INDICARE CON UN SEGNO LE FINITURE SCELTE PER I DIVERSI COMPONENTI

INDICATE WITH A TICK, THE CHOSEN FINISHES FOR ALL THE COMPONENTS

cm 85 x 46 x h83     cm 115 x 46 x h83     cm 140 x 46 x h83

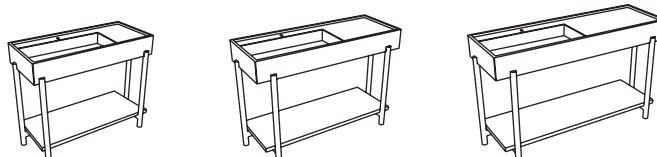

art. **PNST**

## FINITURE STRUTTURA IN ACCIAIO

STEEL FRAMEWORK FINISHES

verniciature\_coatings

- NM - Nero Matt
- CM - Cemento

Le Acque di Cielo

- OL - Oltremare
- SM - Smeraldo
- AL - Alga
- CO - Corallo
- NI - Ninfea
- AM - Anemone

art. **PNSTE**

## FINITURE STRUTTURA IN LEGNO MASSELLO

SOLID WOOD FRAMEWORK FINISHES

essenze legno/wood essences

- RO - Rovere Nero
- RG - Rovere Grigio
- RS - Rovere Sbiancato
- RN - Rovere Naturale

art. **PNPIL / art. PNPIE**

## FINITURE PIANO IN LEGNO

SHELF WOODEN FINISHES

laccature/laquerings

- TL - Talco
- PM - Pomice
- BR - Brina
- AN - Arenaria
- AV - Avena
- CM - Cemento
- BA - Basalto
- MU - Muschio

essenze legno/wood essences

- RO - Rovere Nero
- RG - Rovere Grigio
- RS - Rovere Sbiancato
- RN - Rovere Naturale

## FINITURE LAVABO

WASHBASIN SHELF FINISHES

- Bianco/white - glossy

Le Terre di Cielo

- TL - Talco
- PM - Pomice
- BR - Brina
- BA - Basalto
- LV - Lavagna
- CM - Cemento
- FN - Fango
- CA - Cacao
- AN - Arenaria
- AV - Avena
- LN - Lino
- AG - Agave
- MU - Muschio
- PL - Polvere
- CP - Cipria
- CN - Canapa

Le Acque di Cielo

- OL - Oltremare
- SM - Smeraldo
- AL - Alga
- CO - Corallo
- NI - Ninfea
- AM - Anemone

art. **PNSC**

YES  NO

## FINITURE CESTE IN CUOIO

BASKETS IN LEATHER IN FINISHES

- BI - Bianco \ White
- NA - Cuoio Naturale \ Leather
- NE - Nero \ Black

**N.B. Il lavabo è monoforo predisposto 3 fori, su richiesta può essere prodotto senza foro**

*N.B. The washbasin has 1 hole prepared 3 holes ; may be made without holes upon request*

DATA

DATE

FIRMA DEL CLIENTE

SIGNATURE

ATTENZIONE:

La rappresentazione delle finiture è puramente indicativa. Verificare le finiture con le relative cartelle.

Ogni oggetto possiede la peculiarità di essere elaborato secondo principi puramente tradizionali, in modo da garantirne l'assoluta originalità ed unicità. Le eventuali piccole variazioni di colore, tono o venature fra gli articoli sono da considerarsi pregi e non difetti, in quanto garanzia della fattura manuale del prodotto, che fa di ogni oggetto Cielo un pezzo unico ed esclusivo, lontano dall'omologazione industriale. In fase d'ordine si intendono, pertanto, accettate tali tolleranze che non possono dare adito a contestazioni di alcun genere.

Verificare sempre le disponibilità e i tempi di consegna con il commerciale.

ATTENTION:

The representation of the finishes is merely indicative. Please choose the finishes using the folders.

Every item possesses that particular feature of being processed according to purely traditional principles that guarantee its absolute originality and uniqueness. The small variations in colour, hues or streaks on the items are to be considered as qualities and not defects, since they warranty the handcrafted processing which makes each Cielo item a unique and exclusive piece that cannot be compared to industrial standardization. When making the order, the client implicitly accepts those various features that may give rise to claims of any sort.

Always check the availability and delivery time with the commercial department.



modelli disponibili / available models

**PLINIO**  
collection

cm 140 x 46 x h83

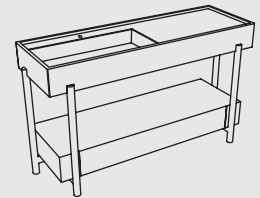

**Plinio mobile con cassetto**  
Plinio cabinet with drawer

cm 115 x 46 x h83

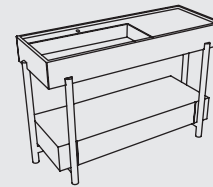

cm 85 x 46 x h83



finiture / finishes

Bianco Lucido  
Gloss White



**LAVABO IN CERAMICA / CERAMIC WASHBASIN**  
**Le Terre di Cielo**

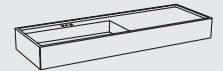

PNLA\  
PNLA115\  
PNLA85

**STRUTTURA IN LEGNO / WOODEN FRAMEWORK**  
**essenze / wooden finishes**



**STRUTTURA IN ACCIAIO / STEEL FRAMEWORK**  
**verniciature / coatings**

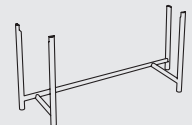
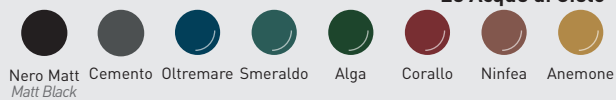

PNST\  
PNST115\  
PNST85

**laccature / lacquers**  
**Le Terre di Cielo**



**CASSETTO E PIANO IN LEGNO / WOODEN DRAWER AND SHELF**  
**essenze / wooden finishes**

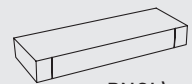
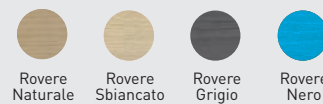

PNCL\  
PNCE\  
PNC115L\  
PNC115E\  
PNC85L\  
PNC85E

**CESTE IN CUOIO / BASKETS IN LEATHER**



PNSC10

**note tecniche lavabo / washbasin technical notes**

monoforo predisposto 3 fori  
with 1 hole prepared 3 holes

senza foro su richiesta  
no tap hole on request

senza troppopieno  
without overflow

con un lato non smaltato  
one side is unglazed

installazione da appoggio  
on top installation

installazione sospesa  
wall-hung installation

**ATTENZIONE: obbligo struttura + lavabo + cassetto/piano**  
PLEASE NOTE: mandatory framework + washbasin + drawer/shelf

# Modulo Ordine Plinio con cassetto

Plinio with drawer Order Form

# cielo

CLIENTE/client:  ORD. REF.:

QUANTITA'/quantity:  EMAIL:

INDICARE CON UN SEGNO LE FINITURE SCELTE PER I DIVERSI COMPONENTI

INDICATE WITH A TICK, THE CHOSEN FINISHES FOR ALL THE COMPONENTS

cm 85 x 46 x h83     cm 115 x 46 x h83     cm 140 x 46 x h83

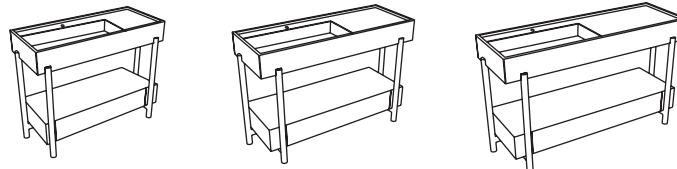

art. **PNST**

## FINITURE STRUTTURA IN ACCIAIO

STEEL FRAMEWORK FINISHES

verniciature\_coatings

- NM - Nero Matt
- CM - Cemento

Le Acque di Cielo

- OL - Oltremare     CO - Corallo
- SM - Smeraldo     NI - Ninfea
- AL - Alga     AM - Anemone

art. **PNSTE**

## FINITURE STRUTTURA IN LEGNO MASSELLO

SOLID WOOD FRAMEWORK FINISHES

essenze legno/wood essences

- RO - Rovere Nero
- RG - Rovere Grigio
- RS - Rovere Sbiancato
- RN - Rovere Naturale

art. **PNCL / art. PNCE**

## FINITURE CASSETTO IN LEGNO

DRAWER WOODEN FINISHES

laccature/laquerings

- TL - Talco     AV - Avena
- PM - Pomice     CM - Cemento
- BR - Brina     BA - Basalto
- AN - Arenaria     MU - Muschio

essenze legno/wood essences

- RO - Rovere Nero
- RG - Rovere Grigio
- RS - Rovere Sbiancato
- RN - Rovere Naturale

## FINITURE LAVABO

WASHBASIN SHELF FINISHES

- Bianco/white - glossy

Le Terre di Cielo

- TL - Talco     AN - Arenaria
- PM - Pomice     AV - Avena
- BR - Brina     LN - Lino
- BA - Basalto     AG - Agave
- LV - Lavagna     MU - Muschio
- CM - Cemento     PL - Polvere
- FN - Fango     CP - Cipria
- CA - Cacao     CN - Canapa

Le Acque di Cielo

- OL - Oltremare     CO - Corallo
- SM - Smeraldo     NI - Ninfea
- AL - Alga     AM - Anemone

art. **PNSC10**    YES  NO

## FINITURE CESTE IN CUOIO

BASKETS IN LEATHER IN FINISHES

- BI - Bianco \ White
- NA - Cuio Naturale \ Leather
- NE - Nero \ Black

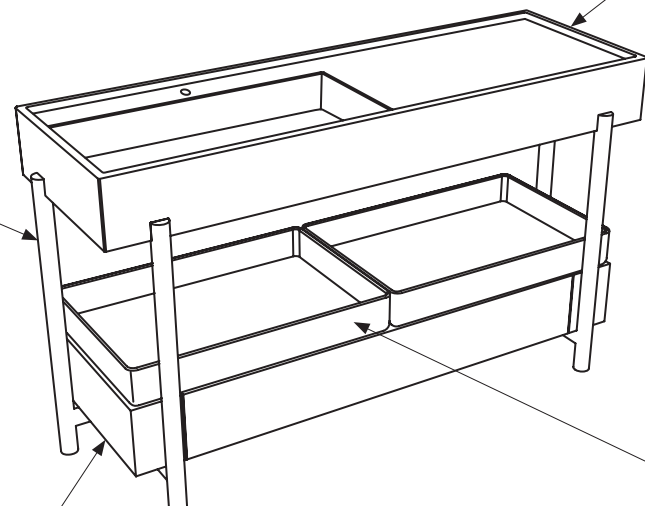

**N.B. Il lavabo è monoforo predisposto 3 fori, su richiesta può essere prodotto senza foro**

*N.B. The washbasin has 1 hole prepared 3 holes ; may be made without holes upon request*

DATA  
DATE

FIRMA DEL CLIENTE  
SIGNATURE

ATTENZIONE:  
La rappresentazione delle finiture è puramente indicativa. Verificare le finiture con le relative cartelle.

ATTENTION:  
The representation of the finishes is merely indicative. Please choose the finishes using the folders.



Ogni oggetto possiede la peculiarità di essere elaborato secondo principi puramente tradizionali, in modo da garantirne l'assoluta originalità ed unicità. Le eventuali piccole variazioni di colore, tono o venature fra gli articoli sono da considerarsi pregi e non difetti, in quanto garanzia della fattura manuale del prodotto, che fa di ogni oggetto Cielo un pezzo unico ed esclusivo, lontano dall'omologazione industriale. In fase d'ordine si intendono, pertanto, accettate tali tolleranze che non possono dare adito a contestazioni di alcun genere.







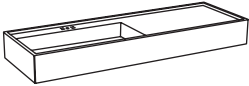
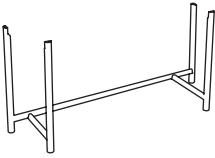



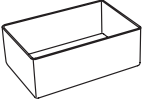



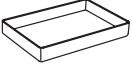

















Every item possesses that particular feature of being processed according to purely traditional principles that guarantee its absolute originality and uniqueness. The small variations in colour, hues or streaks on the items are to be considered as qualities and not defects, since they warranty the handcrafted processing which makes each Cielo item a unique and exclusive piece that cannot be compared to industrial standardization. When making the order, the client implicitly accepts those various features that may give rise to claims of any sort.

Verificare sempre le disponibilità e i tempi di consegna con il commerciale.







Always check the availability and delivery time with the commercial department.



	Size(cm) Medidas Dimensions Maße Размеры	Product code Artículo Article Artikel Артикул	Net weight(Kg) Peso neto Poids net Reingewicht вес нетто	Finishes Acabados Finitions Farbe Отделки	Euro Евро				
 <p><b>Ceramic washbasin with 1 hole</b> Lavabo de cerámica monoagujero Lavabo en céramique avec un trou Waschbecken aus Keramik mit 1 Hahnloch Керамическая раковина на одно отверстие</p>	<b>140</b> x 46 x 16 h	PNLA(X)* PNLASF(X)* no tap hole sin agujero, sans orifice, ohne Loch без отверстия	41,00	● Gloss White ● Le Terre di Cielo ● Le Acque di Cielo	1262,00 1771,00 1771,00				
	<b>115</b> x 46 x 16 h	PNLA115(X)* PNLA115SF(X)* no tap hole sin agujero, sans orifice, ohne Loch без отверстия	34,00	● Gloss White ● Le Terre di Cielo ● Le Acque di Cielo	1083,00 1462,00 1462,00				
	<b>85</b> x 46 x 16 h	PNLA85(X)* PNLA85SF(X)* no tap hole sin agujero, sans orifice, ohne Loch без отверстия	25,00	● Gloss White ● Le Terre di Cielo ● Le Acque di Cielo	931,00 1256,00 1256,00				
<p><b>For on top installation customers are advised to the require the "RETTIFICA" option.</b> Para instalaciones de apoyo se aconseja usar la opción "RETTIFICA" / Pour l'installation à poser on conseille l'option "RETTIFICA" / Bei Aufsatzmontage bitte die Option "RETTIFICA" anfragen / При установке на столешницу рекомендуется запросить опцию "RETTIFICA".</p>					RETTIFICA GRINDING	10,00			
 <p><b>Steel framework</b> Estructura en acero \ Structure en acier \ Gestell aus Stahl \ Структура стальная</p> <p><b>PLEASE NOTE: mandatory framework + washbasin + drawer/shelf</b> obligatorio estructura + lavabo + cajón/encimera obligatoire structure + vasque + tiroir/plan obligatorisch Struktur + Waschbecken + Schublade/Holzregal обязательно конструкция + умывальник + выдвижной ящик / столешница</p>	<b>145</b> x 48 x 71 h	PNST(X)*	15,00	● *X = NM - Matt Black ● *X = CM - Cemento ● Le Acque di Cielo	1239,00 1259,00 1346,00				
	<b>120</b> x 48 x 71 h	PNST115(X)*	12,00	● *X = NM - Matt Black ● *X = CM - Cemento ● Le Acque di Cielo	1179,00 1259,00 1283,00				
	<b>90</b> x 48 x 71 h	PNST85(X)*	11,00	● *X = NM - Matt Black ● *X = CM - Cemento ● Le Acque di Cielo	1028,00 1112,00 1153,00				
<p><b>Wooden framework in solid wood</b> Estructura en MADERA MACIZA \ Structure en bois massif \ Gestell aus MASSIVHOLZ \ Структура из массива дерева</p>	<b>145</b> x 48 x 71 h	PNSTE(X)*	12,00	● Essenze Rovere •	1695,00				
	<b>120</b> x 48 x 71 h	PNST115E(X)*	10,00	● Essenze Rovere •	1652,00				
	<b>90</b> x 48 x 71 h	PNST85E(X)*	8,00	● Essenze Rovere •	1652,00				
 <p><b>Lacquered shelf</b> Encimera lacada \ Plan en bois laqué \ Holzregal lackiert \ Керамическая столешница</p>	<b>135</b> x 42 x 2 h	PNPIL(X)*	7,50	● Le Terre di Cielo *	326,00				
	<b>110</b> x 42 x 2 h	PNPI115L(X)*	6,00	● Le Terre di Cielo *	326,00				
	<b>80</b> x 42 x 2 h	PNPI85L(X)*	4,00	● Le Terre di Cielo *	313,00				
<p><b>Shelf in wooden finish</b> Encimera de madera \ Plan en bois \ Holzregal \ столешница с отделкой натуральным шпоном</p>	<b>135</b> x 42 x 2 h	PNPIE(X)*	7,50	● Essenze Rovere •	447,00				
	<b>110</b> x 42 x 2 h	PNPI115E(X)*	6,00	● Essenze Rovere •	447,00				
	<b>80</b> x 42 x 2 h	PNPI85E(X)*	4,00	● Essenze Rovere •	422,00				
 <p><b>Lacquered drawer</b> Cajón lacado \ Tiroir laqué Schubfach lackiert \ Крашенный ящик</p>	<b>135</b> x 42 x 18,5 h	PNCL(X)*	27,50	● Le Terre di Cielo *	1332,00				
	<b>110</b> x 42 x 18,5 h	PNC115L(X)*	24,00	● Le Terre di Cielo *	1273,00				
	<b>80</b> x 42 x 18,5 h	PNC85L(X)*	19,00	● Le Terre di Cielo *	1235,00				
<p><b>Drawer in wooden finish</b> Cajón de madera \ Tiroir en bois Holzschubfach \ Ящик с отделкой натуральным шпоном</p>	<b>135</b> x 42 x 18,5 h	PNCE(X)*	27,50	● Essenze Rovere •	1701,00				
	<b>110</b> x 42 x 18,5 h	PNC115E(X)*	24,00	● Essenze Rovere •	1609,00				
	<b>80</b> x 42 x 18,5 h	PNC85E(X)*	19,00	● Essenze Rovere •	1557,00				

	Size(cm)	Product code	Net weight(Kg)	Finishes	Euro	
	Medidas Dimensions Maße Размеры	Artículo Article Artikel Артикул	Peso neto Poids net Reingewicht вес нетто	Acabados Finitions Farbe Отделки	Евро	
	<b>Basket in leather h28 for Plinio 140</b> Cesta en cuero h28 para Plinio 140 \ Panier en cuir h28 pour Plinio 140 \ Lederkorb h28 für Plinio 140 \ Корзина из кожи h28 для Plinio 140	63 x 36 x 28 h	PNSC(X)*	3,50	<ul style="list-style-type: none"> <li> *X = BI - White</li> <li> *X = NA - Leather</li> <li> *X = NE - Black</li> </ul>	<ul style="list-style-type: none"> <li>881,00</li> <li>881,00</li> <li>881,00</li> </ul>
	<b>Basket in leather h10 for plinio 140</b> Cesta en cuero h10 para Plinio 140 \ Panier en cuir h10 pour plinio 140 \ Lederkorb h10 für Plinio 140 \ Корзина из кожи h10 для Plinio 140	63 x 36 x 10 h	PNSC10(X)*	2,00	<ul style="list-style-type: none"> <li> *X = BI - White</li> <li> *X = NA - Leather</li> <li> *X = NE - Black</li> </ul>	<ul style="list-style-type: none"> <li>663,00</li> <li>663,00</li> <li>663,00</li> </ul>
	<b>Universal click/clack drain in CHROME with ceramic lid</b> Válvula universal click/clack Cromado con tapa en cerámica \ Bonde universelle clic/clac Chromé avec clapet en céramique \ Universal-Abflussgarnitur Click-Clack Chrom mit Keramikstopfen \ Универсальный донный клапан click/clack хром с керамической крышкой		PIL01(X)*	0,40	<ul style="list-style-type: none"> <li> Gloss White</li> <li> Le Terre di Cielo</li> <li> Le Acque di Cielo</li> </ul>	<ul style="list-style-type: none"> <li>95,00</li> <li>139,00</li> <li>139,00</li> </ul>
	<b>Universal click/clack drain in BLACK MATT finish with ceramic lid</b> Válvula universal click/clack Negro Matt con tapa en cerámica \ Bonde universelle clic/clac Noir Mat avec clapet en céramique \ Universal-Abflussgarnitur Click-Clack Matt Schwarz mit Keramikstopfen \ Универсальный донный клапан click/clack черный матовый с керамической крышкой		PIL01NM(X)*	0,40	<ul style="list-style-type: none"> <li> Gloss White</li> <li> Le Terre di Cielo</li> <li> Le Acque di Cielo</li> </ul>	<ul style="list-style-type: none"> <li>120,00</li> <li>169,00</li> <li>169,00</li> </ul>
	<b>Universal click/clack drain in CEMENTO finish with ceramic lid</b> Válvula universal click/clack Cemento con tapa en cerámica \ Bonde universelle clic/clac Cemento avec clapet en céramique \ Universal-Abflussgarnitur Click-Clack Cement mit Keramikstopfen \ Универсальный донный Cemento click/clack с керамической крышкой		PIL01CM(X)*	0,40	<ul style="list-style-type: none"> <li> Gloss White</li> <li> Le Terre di Cielo</li> <li> Le Acque di Cielo</li> </ul>	<ul style="list-style-type: none"> <li>120,00</li> <li>169,00</li> <li>169,00</li> </ul>
	<b>Universal click/clack drain in BRONZE with ceramic lid</b> Válvula universal click/clack Bronce con tapa en cerámica \ Bonde universelle clic/clac Bronze avec clapet en céramique \ Universal-Abflussgarnitur Click-Clack Bronze mit Keramikstopfen \ Универсальный донный клапан click/clack бронза с керамической крышкой		PIL01BR(X)*	0,40	<ul style="list-style-type: none"> <li> Gloss White</li> <li> Le Terre di Cielo</li> <li> Le Acque di Cielo</li> </ul>	<ul style="list-style-type: none"> <li>135,00</li> <li>182,00</li> <li>182,00</li> </ul>
	<b>CHROMED siphon</b> Sifone Cromado \ Siphon Chromé \ Siphon Verchromt \ сифон Chrome		SISP	0,93	 Chrome	133,00
	<b>MATT BLACK siphon</b> Sifone Negro Mate \ Siphon Noir Mat \ Siphon Schwarz Matt \ Сифон Черный матовый		SIFN	0,93	 Matt Black	194,00
	<b>CEMENTO siphon</b> Sifone Cemento \ Siphon Cemento \ Siphon Cemento \ сифон Cemento		SIFCM	0,93	 Cemento	194,00
	<b>BRONZE siphon</b> Sifone Bronce \ Siphon Bronze \ Siphon Bronze \ бронза сифон		SIFBR	0,93	 Bronze	220,00

Acque di Cielo available for washbasins and steel framework | Acque di Cielo disponibles para el lavabo y Estructura en acero | Acque di Cielo disponibles pour le lavabo et Structure en acier | Für Waschbecken erhältliche Acque di Cielo. Gestell aus Stahl | Отделка Acque di Cielo доступны для раковины, Структура стальная

-  OL - Oltremare
-  SM - Smeraldo
-  AL - Alga
-  CO - Corallo
-  NI - Ninfea
-  AM - Anemone

Terre di Cielo available for ceramic washbasin | Terre di Cielo disponibles para lavabo de cerámica | Terre di Cielo disponibles pour les lavabos en céramique | Für Waschbecken erhältliche Terre di Cielo | Отделка Terre di Cielo доступны для раковин и керамических столешниц

-  TL - Talco
-  PM - Pomice
-  BR - Brina
-  BA - Basalto
-  LV - Lavagna
-  CM - Cemento
-  FN - Fango
-  CA - Cacao
-  AN - Arenaria
-  AV - Avena
-  LN - Lino
-  AG - Agave
-  MU - Muschio
-  PL - Polvere
-  CP - Cipria
-  CN - Canapa







\* Terre di Cielo laquering available for drawer and shelf | lacados Terre di Cielo disponibles para cajones y encimeras | laquages Terre di Cielo disponibles pour le tiroir et le plan | Für Schublade und Platte erhältliche Lackierungen Terre di Cielo | крашенная отделка Terre di Cielo доступна для ящика и столешницы

-  TL - Talco
-  PM - Pomice
-  BR - Brina
-  AN - Arenaria
-  BA - Basalto
-  MU - Muschio
-  AV - Avena
-  CM - Cemento

● **Essenze Rovere**

-  RS - Rovere Sbiancato
-  RN - Rovere Naturale
-  RG - Rovere Grigio
-  R0 - Rovere Nero

Technical symbols legend | Símbolos técnicos clave | Légende symboles techniques | Technische Zeichenerklärung | Перечень технических символов

-  with 1 hole prepared 3 holes | con 1 agujero pre-dispuesto para 3 | avec un trou prédisposé à trois trous | mit 1-Loch auf 3-Loch durchschlagbar \ одно отверстие с возможностью выполнения трех отверстий
-  no tap hole on request | sin agujero, solo a petición | sans orifice sur demande | ohne Überlauf | без отверстия под смеситель по запросу
-  without overflow | sin rebosadero | sans trop-plein | ohne Überlauf | без слива-перелива
-  one side is unglazed | con un lado sin esmaltar | avec un côté non émaillé | eine Seite unglasiert | одна сторона не покрыта эмалью
-  on top installation | instalación de apoyo | installation à partir du plan | Montage auf Platte | установка на столешницу
-  wall-hung installation | instalación suspendida | installation suspendue | wandhängende Montage | подвесная установка
-  with fixing parts | fijaciones incluidas | fixations incluses | inklusive Befestigungen | в комплекте с крепежами

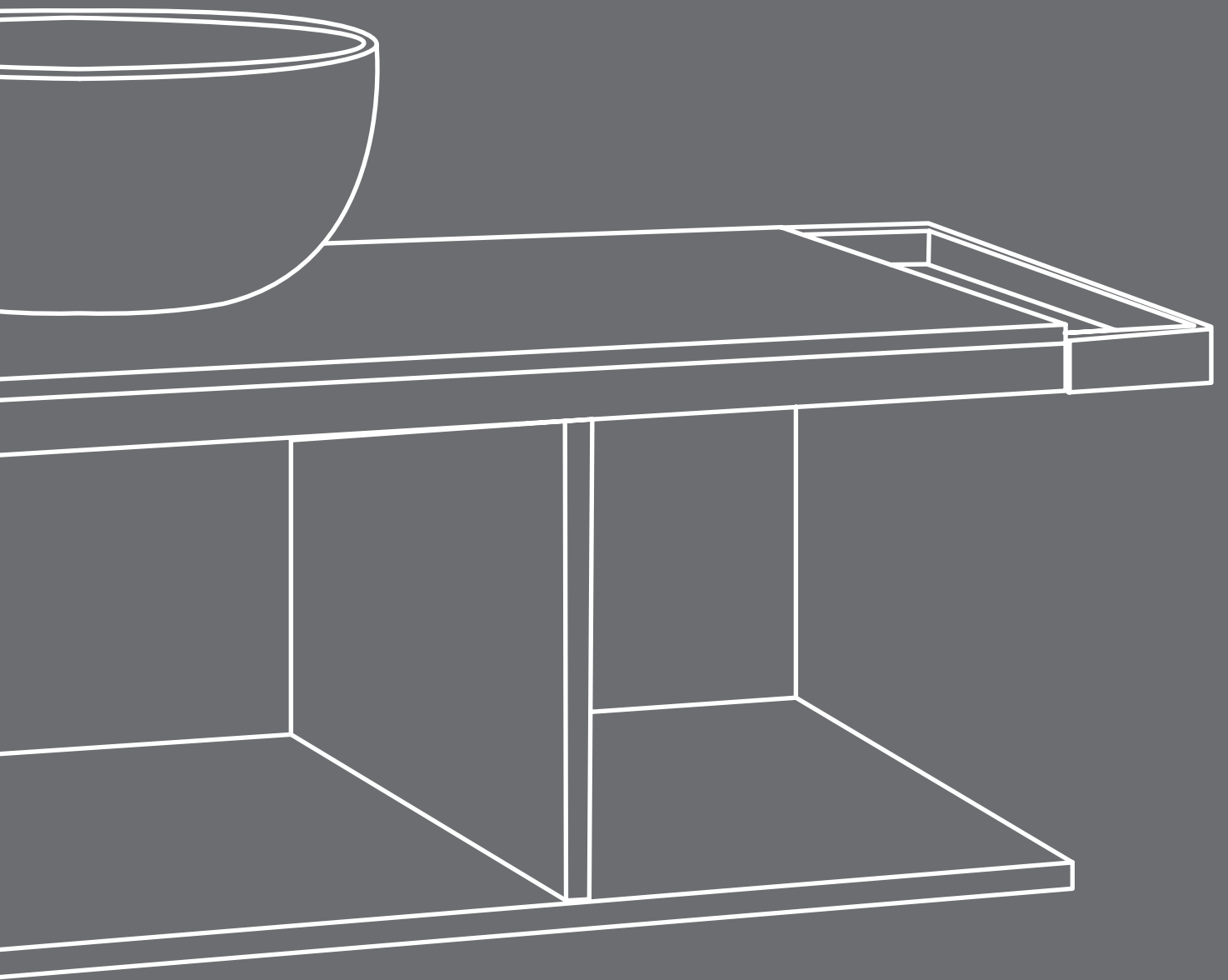

# Multiplo

design **Andrea Parisio & Giuseppe Pezzano**

QR code configuratore \ configurator pg. 276

indice collezione \ collection index pg. 277

listino prezzi \ price list pg. 282 - 287











## It is mandatory to send the Multiplo order form via the configurator.

Es obligatorio enviar el modulo de Pedido Múltiplo a través del configurador.

Il est obligatoire d'envoyer le formulaire de commande de Multiplo via le configurateur.

Das Bestellformular für Multiplo kann ausschließlich über den Konfigurator verschickt werden.

Обязательно необходимо отправить форму заказа Multiplo через конфигуратор.

The screenshot shows the 'CONFIGURATORE' interface for the 'cielo' brand. At the top, there's a navigation bar with 'Prodotti' and a shopping cart icon. Below it, a row of product thumbnails is visible, including 'Multiplo piano 90', 'Multiplo piano 120', 'Multiplo piano 140', and various 'Multiplo mobile a giorno' models. The main content area features a 3D rendering of a 'Multiplo 140 mobile a giorno' vanity unit with a yellow basin. To the right of the rendering, there's a configuration panel titled 'Multiplo 140 mobile a giorno' with the description 'Piano in ceramica + mobile a giorno con struttura in acciaio verniciato Cemento o Nero Matt'. Below this, users can 'Scegli le finiture del prodotto' (Choose the product finishes), with options for 'Lavabo' (Sink) and 'Posizione lavabo e foro rubinetto' (Sink and faucet position). The sink position options include: 'lavabo a sinistra con rubinetto a sinistra', 'lavabo a destra con rubinetto a destra', 'lavabo al centro con rubinetto a sinistra', 'lavabo al centro con rubinetto a destra', 'doppio lavabo con rubinetto estetico', 'lavabo a sinistra senza rubinetto', 'lavabo a destra senza rubinetto', 'lavabo al centro senza rubinetto', and 'doppio lavabo senza rubinetto'. The configuration panel also lists selected components: 'Piano Multiplo 140', 'Mobile a giorno con struttura Nero Matt', 'Mobile a giorno con struttura Cemento', 'Portasciugamani laterale Multiplo', and 'Specchio'. At the bottom, there are buttons for 'SALVA NEL CARRELLO IL PRODOTTO CONFIGURATO', 'Aggiungi gli accessori correlati', and 'Aggiungi altri prodotti'.

EN

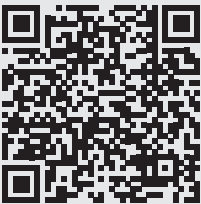

go to the  
configurator

SP



ir al  
configurador

FR



lien vers le  
configurateur

RU

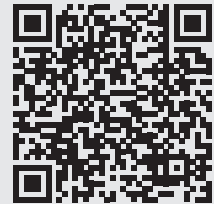

Перейдите в  
конфигуратор

## Lavabo con mobile / washbasin with cabinet

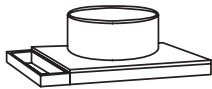

**Minimultiplo:**  
lavabo Minimo + piano cm 40 x 29  
washbasin Minimo + countertop cm 40 x 29  
pag. 282

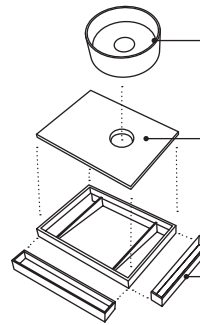
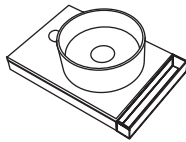
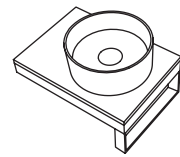

**lavabo in ceramica**  
ceramic washbasin

**piano in ceramica**  
ceramic countertop

**struttura e portasciugamani in acciaio**  
steel framework and towel rail

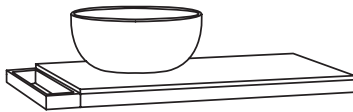

**Multiplo:**  
lavabo + piano  
washbasin + countertop  
pag. 283

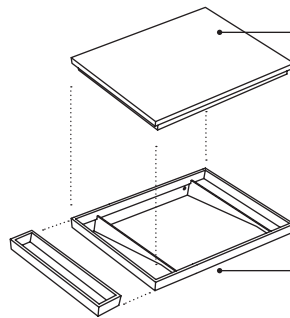

**piano in ceramica**  
ceramic countertop

**struttura e portasciugamani in acciaio**  
steel framework and towel rail

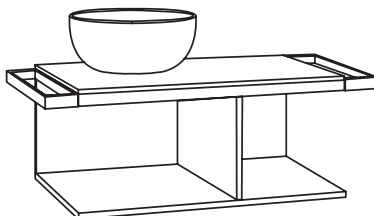

**Multiplo:**  
lavabo + piano con mobile a  
giorno wasbasin + top with open  
day cabinet  
pag. 284

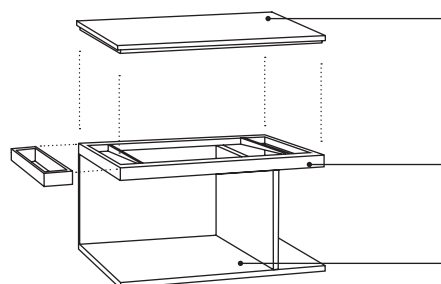

**piano in ceramica**  
ceramic countertop

**struttura e portasciugamani in acciaio**  
steel framework and towel rail

**mobile a giorno**  
open day cabinet

modelli disponibili / available models

## MINIMULTIPLO

collection

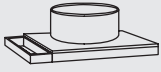

### Minimultiplo

lavabo Minimo + piano cm 40 x 29

washbasin Minimo + countertop cm 40 x 29

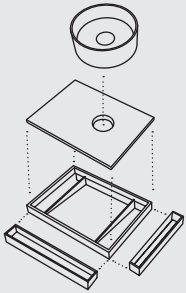

finiture / finishes



MILAT



MILAQ

+



MUPI40

+

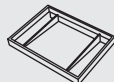

MUST40

+



MUPSL40 \ MUPSF40

LAVABO MINIMO IN CERAMICA, TONDO O QUADRATO / MINIMO CERAMIC WASHBASIN, ROUND OR SQUARE

Le Terre di Cielo



Le Acque di Cielo

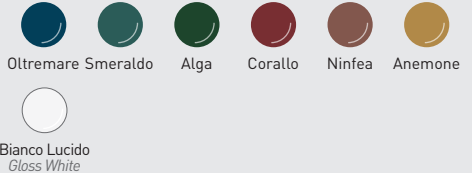

PIANO IN CERAMICA / CERAMIC TOP

Le Terre di Cielo



Le Acque di Cielo

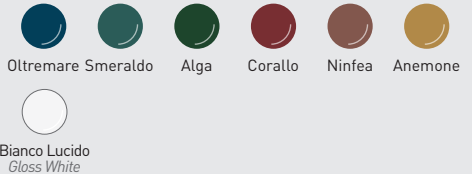

STRUTTURA PER PIANO / FRAMEWORK FOR TOP

verniciature parte metallica / metal parts coatings

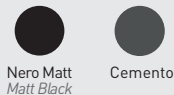

PORTASCIUGAMANI IN ACCIAIO / STEEL TOWEL RAIL

verniciature / coatings

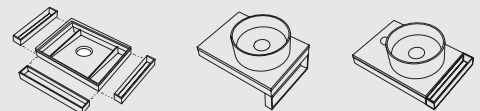
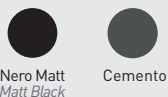

1. composizione obbligatoria: lavabo da appoggio Cielo + top + struttura  
mandatory combination: Cielo on top washbasin + top + framework

2. foro rubinetto su richiesta (posizioni obbligate - vedi scheda tecnica)  
tap/faucet hole on request (mandatory position - see technical data sheet).





modelli disponibili / available models

## MULTIPLIO collection



**Multiplo**  
lavabo + piano  
washbasin + countertop

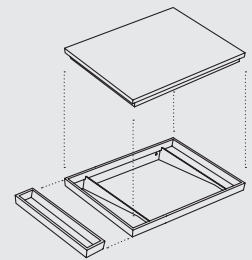

finiture / finishes

### Le Acque di Cielo

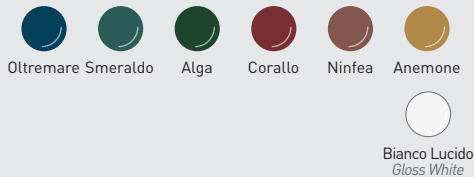

### PIANO IN CERAMICA / CERAMIC TOP

#### Le Terre di Cielo



cm 50 x 48 x 3,5 h  
cm 70 x 48 x 3,5 h  
cm 90 x 48 x 3,5 h  
cm 120 x 48 x 3,5 h  
cm 140 x 48 x 3,5 h

### STRUTTURA PER PIANO / FRAMEWORK FOR TOP

verniciature parte metallica / metal parts coatings

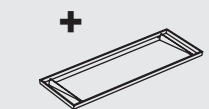
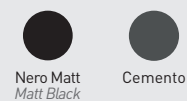

cm 50 x 48 x 10 h  
cm 70 x 48 x 10 h  
cm 90 x 48 x 10 h  
cm 120 x 48 x 10 h  
cm 140 x 48 x 10 h

### PORTASCIUGAMANI IN ACCIAIO / STEEL TOWEL RAIL

verniciature / coatings

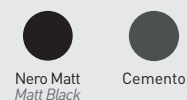

MUPLS

### lavabi installabili / washbasins

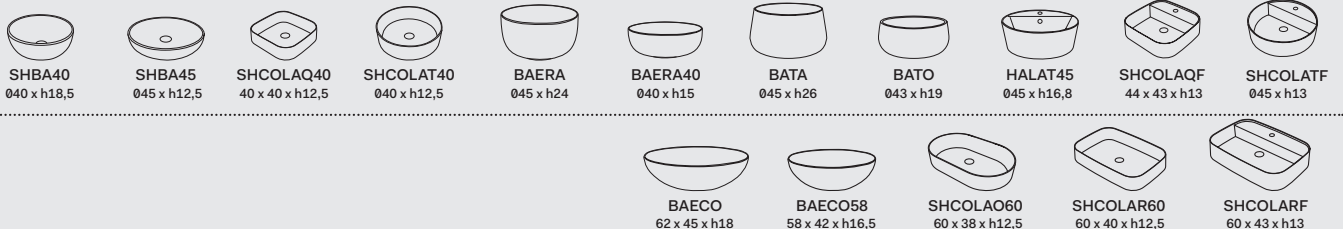

1. composizione obbligatoria: lavabo da appoggio Cielo + top + struttura  
mandatory combination: Cielo on top washbasin + top + framework

2. foro rubinetto su richiesta (posizioni obbligate - vedi scheda tecnica)  
tap/Faucet hole on request (mandatory position - see technical data sheet).



modelli disponibili / available models

## MULTIPLO

collection

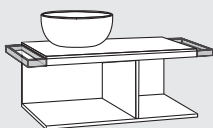

### Multiplo

lavabo + piano con mobile a giorno

wasbasin + top with open day cabinet

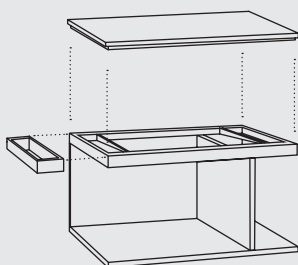

finiture / finishes

### PIANO IN CERAMICA / CERAMIC TOP

#### Le Terre di Cielo



#### Le Acque di Cielo

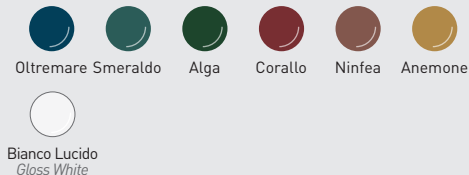

cm 50 x 48 x 3,5 h  
cm 70 x 48 x 3,5 h  
cm 90 x 48 x 3,5 h  
cm 120 x 48 x 3,5 h  
cm 140 x 48 x 3,5 h

### MOBILE A GIORNO / OPEN DAY CABINET

laccature mobile in legno / cabinet wooden lacquering

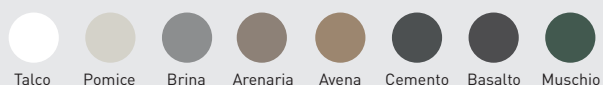

### verniciature parte metallica

metal parts coatings

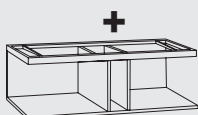
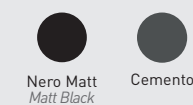

cm 50 x 48 x 38 h  
cm 70 x 48 x 38 h  
cm 90 x 48 x 38 h  
cm 120 x 48 x 38 h  
cm 140 x 48 x 38 h

### PORTASCIUGAMANI IN ACCIAIO / STEEL TOWEL RAIL

verniciature / coatings

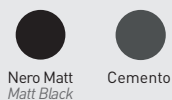

lavabi installabili / washbasins

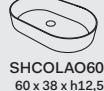

1. composizione obbligatoria: lavabo da appoggio Cielo + top + struttura  
mandatory combination: Cielo on top washbasin + top + framework
2. foro rubinetto su richiesta (posizioni obbligate - vedi scheda tecnica)  
tap/Faucet hole on request (mandatory position - see technical data sheet).



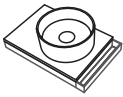









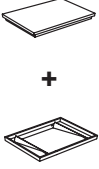













# Minimultiplo

ceramic top + steel framework in Cemento or Nero Matt finish

encimera en cerámica + estructura en acero - acero pintado en Cemento o Nero Matt | plan céramique + structure en acier laqué cemento ou noir mat | Platte aus Keramik + Gestell aus Stahl, Zement oder matt Schwarz lackiert | Столешница керамическая + структура из стали, в отделке Cemento или Nero Matt

# cielo

	Size (cm) Medidas Dimensions Maße Размеры	Product code Artículo Article Artikel Артикул	Net weight (kg) Peso neto Poids net Reingewicht вес нетто	Finishes Acabados Finitions Farbe Отделки	Euro Евро
 	40 x 29 x h 3,5	MUPI40(X)*	4,50	<b>top</b> encimera \ plan \ Holzregal \ столешница <ul style="list-style-type: none"> <li> <b>Gloss White</b></li> <li> <b>Le Terre di Cielo</b></li> <li> <b>Le Acque di Cielo</b></li> </ul>	<b>313,00</b> <b>334,00</b> <b>334,00</b>
	40 x 29 x h 10	MUST40(X)*	4,50	<b>framework</b> estructura \ structure \ gestell \ структура <ul style="list-style-type: none"> <li> <b>*X = NM - Matt Black</b></li> <li> <b>*X = CM - Cemento</b></li> </ul>	<b>286,00</b> <b>286,00</b>
	25 x 25 x 11,5 h	MILAT(X)*	3,15	<ul style="list-style-type: none"> <li> <b>Gloss White</b></li> <li> <b>*X = N - Gloss Black</b></li> <li> <b>Le Terre di Cielo</b></li> <li> <b>Le Acque di Cielo</b></li> </ul>	<b>277,00</b> <b>413,00</b> <b>413,00</b> <b>413,00</b>
	25 x 25 x 11,5 h	MILAQ(X)*	3,15	<ul style="list-style-type: none"> <li> <b>Gloss White</b></li> <li> <b>*X = N - Gloss Black</b></li> <li> <b>Le Terre di Cielo</b></li> <li> <b>Le Acque di Cielo</b></li> </ul>	<b>277,00</b> <b>413,00</b> <b>413,00</b> <b>413,00</b>
	29 x 6 x h 4	MUPSL40(X)*	1,10	<ul style="list-style-type: none"> <li> <b>*X = NM - Matt Black</b></li> <li> <b>*X = CM - Cemento</b></li> </ul>	<b>154,00</b> <b>154,00</b>
	40 x 6 x h 4	MUPSF40(X)*	1,40	<ul style="list-style-type: none"> <li> <b>*X = NM - Matt Black</b></li> <li> <b>*X = CM - Cemento</b></li> </ul>	<b>167,00</b> <b>167,00</b>
<b>Tap/Faucet hole on request</b> <b>(mandatory position – see technical data sheet).</b> \ Orificio grifo a petición [posición obligada-veáse ficha técnica] \ Trou de robinet sur demande [position obligée – voir fiche technique] \ Hinweis: Hahnloch auf Anfrage [Position obligatorisch – siehe technisches Datenblatt] \ Отверстие под смеситель по запросу (возможное место расположения отверстия – проверьте на технической)					<b>25,00</b>

## mandatory combination: Cielo on top washbasin + top + framework

combinaison obligatoire: cubeta de apoyo Cielo + encimera + estructura  
combinación obligatoria: vasque à poser Cielo + plan + structure  
obligatorische Kombination: Aufsatzbecken Cielo + Holzregal + gestell  
обязательное сочетание: Накладная + столешница + структура

### Technical symbols legend / Símbolos técnicos clave / Légende symboles techniques / Technische Zeichenerklärung / Перечень технических символов

 **all sides are enamelled**  
con todos los lados esmaltados  
avec tous les côtés émaillés  
alle Seiten glasiert  
все стороны покрыты эмалью

 **no tap holes**  
sin agujero para grifo  
sans orifice robinet  
ohne Hahnloch  
без отверстия под смеситель

 **without overflow**  
sin rebosadero  
sans trop-plein  
ohne Überlauf  
без слива-перелива

 **on top installation**  
instalación de apoyo  
installation à partir du plan  
Montage auf Platte  
установка на столешницу



# Multiplo

## ceramic top + steel framework in Cemento or Nero Matt finish

encimera en cerámica + estructura en acero acero pintado en Cemento o Nero Matt | plan céramique + structure en acier laqué cemento ou noir mat | Platte aus Keramik + Gestell aus Stahl, Zement oder matt Schwarz lackiert | Столешница керамическая + структура из стали, в отделке Cemento или Nero Matt

# cielo

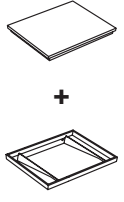
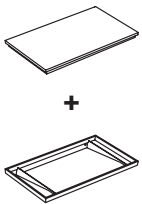
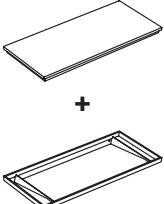
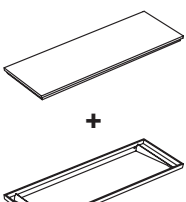
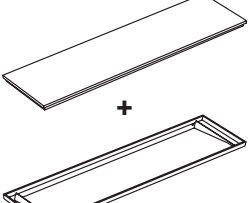
	Size (cm) Medidas Dimensions Maße Размеры	Product code Artículo Article Artikel Артикул	Net weight (Kg) Peso neto Poids net Reingewicht вес нетто	Finishes Acabados Finitions Farbe Отделки	Euro Евро	
50		50 x 48 x h3,5	MUPI50(X)*	10,00	<b>top</b> encimera \ plan \ Holzregal \ столешница <span style="color: #ccc;">●</span> Gloss White 412,00 <span style="color: #8b4513;">●</span> Le Terre di Cielo 427,00 <span style="color: #008080;">●</span> Le Acque di Cielo 427,00	
		50 x 48 x h10	MUST50(X)*	4,00	<b>framework</b> estructura \ structure \ gestell \ структура <span style="color: #000000;">●</span> *X = NM - Matt Black 383,00 <span style="color: #4b4b4b;">●</span> *X = CM - Cemento 383,00	
70		70 x 48 x h3,5	MUPI70(X)*	13,00	<b>top</b> encimera \ plan \ Holzregal \ столешница <span style="color: #ccc;">●</span> Gloss White 548,00 <span style="color: #8b4513;">●</span> Le Terre di Cielo 601,00 <span style="color: #008080;">●</span> Le Acque di Cielo 601,00	
		70 x 48 x h10	MUST70(X)*	6,00	<b>framework</b> estructura \ structure \ gestell \ структура <span style="color: #000000;">●</span> *X = NM - Matt Black 527,00 <span style="color: #4b4b4b;">●</span> *X = CM - Cemento 527,00	
90		90 x 48 x h3,5	MUPI90(X)*	17,00	<b>top</b> encimera \ plan \ Holzregal \ столешница <span style="color: #ccc;">●</span> Gloss White 701,00 <span style="color: #8b4513;">●</span> Le Terre di Cielo 746,00 <span style="color: #008080;">●</span> Le Acque di Cielo 746,00	
		90 x 48 x h10	MUST90(X)*	5,30	<b>framework</b> estructura \ structure \ gestell \ структура <span style="color: #000000;">●</span> *X = NM - Matt Black 624,00 <span style="color: #4b4b4b;">●</span> *X = CM - Cemento 624,00	
120		120 x 48 x h3,5	MUPI120(X)*	20,00	<b>top</b> encimera \ plan \ Holzregal \ столешница <span style="color: #ccc;">●</span> Gloss White 828,00 <span style="color: #8b4513;">●</span> Le Terre di Cielo 885,00 <span style="color: #008080;">●</span> Le Acque di Cielo 885,00	
		120 x 48 x h10	MUST120(X)*	6,50	<b>framework</b> estructura \ structure \ gestell \ структура <span style="color: #000000;">●</span> *X = NM - Matt Black 716,00 <span style="color: #4b4b4b;">●</span> *X = CM - Cemento 716,00	
140		140 x 48 x h3,5	MUPI140(X)*	22,00	<b>top</b> encimera \ plan \ Holzregal \ столешница <span style="color: #ccc;">●</span> Gloss White 929,00 <span style="color: #8b4513;">●</span> Le Terre di Cielo 994,00 <span style="color: #008080;">●</span> Le Acque di Cielo 994,00	
		140 x 48 x h10	MUST140(X)*	7,00	<b>framework</b> estructura \ structure \ gestell \ структура <span style="color: #000000;">●</span> *X = NM - Matt Black 785,00 <span style="color: #4b4b4b;">●</span> *X = CM - Cemento 785,00	
<b>Towel rail (optional)</b> Toallero (opcional) \ porte-serviette (en option) \ Handtuchhalter (fakultativ) \ Полотенцедержатель (опциональный)		48 x 6 x h 4	MUPSL(X)*	1,80	<span style="color: #000000;">●</span> *X = NM - Matt Black 167,00 <span style="color: #4b4b4b;">●</span> *X = CM - Cemento 167,00	
<b>Tap/Faucet hole on request</b> (mandatory position - see technical data sheet). \ Orificio grifo a petición (posición obligada-veáse ficha técnica) \ Trou de robinet sur demande (position obligée - voir fiche technique) \ Hinweis: Hahnloch auf Anfrage (Position obligatorisch - siehe technisches Datenblatt) \ Отверстие под смеситель по запросу (возможное место расположения отверстия - проверьте на технической)					25,00	

**Terre di Cielo available for ceramic top** | Terre di Cielo disponibles para la encimera de cerámica | Terre di Cielo disponibles pour le plan en céramique | Für Keramikplatte erhältliche Terre di Cielo | Отделку Terre di Cielo доступны для керамических столешниц

- TL - Talco
- PM - Pomice
- BR - Brina
- BA - Basalto
- LN - Lino
- FN - Fango
- CA - Cacao
- AN - Arenaria
- AV - Avena
- CM - Cemento
- MU - Muschio
- AG - Agave
- PL - Polvere
- CP - Cipria
- CN - Canapa
- LV - Lavagna

**Acque di Cielo available for ceramic top** | Acque di Cielo disponibles para la encimera de cerámica | Acque di Cielo disponibles pour le plan en céramique | Für Keramikplatte erhältliche Acque di Cielo | Отделку Acque di Cielo доступны для керамических столешниц

- OL - Oltremare
- SM - Smeraldo
- AL - Alga
- CO - Corallo
- NI - Ninfea
- AM - Anemone



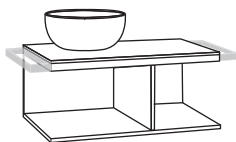













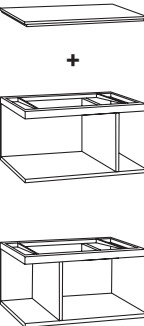



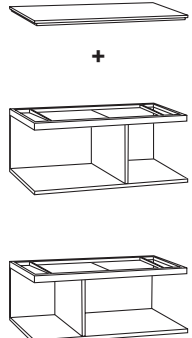



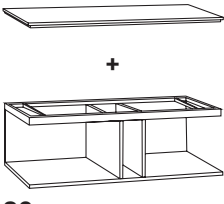

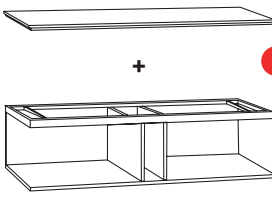

# Multiplo

# cielo

## Ceramic top + open day cabinet with steel framework in Cemento or Matt Black finish

Encimera en ceramica + mueble con estructura en acero pintado Cemento o Nero Matt | Plan céramique + meuble console en acier émaillé Cemento ou noir mat | Platte aus Keramik + offenes Möbel mit Gestell aus Stahl, Zement oder matt Schwarz lackiert | Столешница керамическая + мебель с открытыми полками и структурой из стали, в отделке Cemento или Nero Matt

	Size (cm) Medidas Dimensions Maße Размеры	Product code Artículo Article Artikel Артикул	Net weight (Kg) Peso neto Poids net Reingewicht вес нетто	Finishes Acabados Finitions Farbe Отделка	Euro Евро	
 50	 +	50 x 48 x h3,5	MUPI50(X)*	10,00	<b>top</b> encimera \ plan \ Holzregal столешница <ul style="list-style-type: none"> <li> Gloss White</li> <li> Le Terre di Cielo</li> <li> Le Acque di Cielo</li> </ul>	412,00 427,00 427,00
		50 x 48 x h38	MUMBG50NM(X)*	12,00	<b>lacquered cabinet with framework in Matt Black finish*</b> mueble lacado con estructura en Nero Matt* \ meuble laqué noir mat \ Möbel lackiert, mit Gestell matt Schwarz* \ Тумбы крашенные со структурой в отделке *	1098,00
	MUMBG50CM(X)*		12,00	<b>lacquered cabinet with framework in Cemento finish*</b> mueble lacado con estructura en Cemento* \ meuble laqué Cemento \ Möbel lackiert, mit Gestell Cemento* \ Тумбы крашенные со структурой в отделке Cemento *	1098,00	
	 70	 +	70 x 48 x h3,5	MUPI70(X)*	13,00	<b>top</b> encimera \ plan \ Holzregal столешница <ul style="list-style-type: none"> <li> Gloss White</li> <li> Le Terre di Cielo</li> <li> Le Acque di Cielo</li> </ul>
70 x 48 x h38			MUMBG70NM(X)*	16,5	<b>lacquered cabinet with framework in Matt Black finish*</b> mueble lacado con estructura en Nero Matt* \ meuble laqué noir mat \ Möbel lackiert, mit Gestell matt Schwarz* \ Тумбы крашенные со структурой в отделке *	1124,00
		MUMBG70CM(X)*	16,5	<b>lacquered cabinet with framework in Cemento finish*</b> mueble lacado con estructura en Cemento* \ meuble laqué Cemento \ Möbel lackiert, mit Gestell Cemento* \ Тумбы крашенные со структурой в отделке Cemento *	1124,00	
70 x 48 x h38		MUMBG70DXNM(X)*	16,5	<b>lacquered cabinet with framework in Matt Black finish*</b> mueble lacado con estructura en Nero Matt* \ meuble laqué noir mat \ Möbel lackiert, mit Gestell matt Schwarz* \ Тумбы крашенные со структурой в отделке *	1124,00	
		MUMBG70DXCM(X)*	16,5	<b>lacquered cabinet with framework in Cemento finish*</b> mueble lacado con estructura en Cemento* \ meuble laqué Cemento \ Möbel lackiert, mit Gestell Cemento* \ Тумбы крашенные со структурой в отделке Cemento *	1124,00	
 90		 +	90 x 48 x h3,5	MUPI90(X)*	17,00	<b>top</b> encimera \ plan \ Holzregal столешница <ul style="list-style-type: none"> <li> Gloss White</li> <li> Le Terre di Cielo</li> <li> Le Acque di Cielo</li> </ul>
	90 x 48 x h38		MUMBG90NM(X)*	21,50	<b>lacquered cabinet with framework in Matt Black finish*</b> mueble lacado con estructura en Nero Matt* \ meuble laqué noir mat \ Möbel lackiert, mit Gestell matt Schwarz* \ Тумбы крашенные со структурой в отделке *	1375,00
		MUMBG90CM(X)*	21,50	<b>lacquered cabinet with framework in Cemento finish*</b> mueble lacado con estructura en Cemento* \ meuble laqué Cemento \ Möbel lackiert, mit Gestell Cemento* \ Тумбы крашенные со структурой в отделке Cemento *	1375,00	
	90 x 48 x h38	MUMBG90DXNM(X)*	21,50	<b>lacquered cabinet with framework in Matt Black finish*</b> mueble lacado con estructura en Nero Matt* \ meuble laqué noir mat \ Möbel lackiert, mit Gestell matt Schwarz* \ Тумбы крашенные со структурой в отделке *	1375,00	
		MUMBG90DXCM(X)*	21,50	<b>lacquered cabinet with framework in Cemento finish*</b> mueble lacado con estructura en Cemento* \ meuble laqué Cemento \ Möbel lackiert, mit Gestell Cemento* \ Тумбы крашенные со структурой в отделке Cemento *	1375,00	
	 120	 +	120 x 48 x h3,5	MUPI120(X)*	20,00	<b>top</b> encimera \ plan \ Holzregal \ столешница <ul style="list-style-type: none"> <li> Gloss White</li> <li> Le Terre di Cielo</li> <li> Le Acque di Cielo</li> </ul>
120 x 48 x h38			MUMBG120NM(X)*	25,00	<b>lacquered cabinet with framework in Matt Black finish*</b> mueble lacado con estructura en Nero Matt* \ meuble laqué noir mat \ Möbel lackiert, mit Gestell matt Schwarz* \ Тумбы крашенные со структурой в отделке *	1642,00
		MUMBG120CM(X)*	25,00	<b>lacquered cabinet with framework in Cemento finish*</b> mueble lacado con estructura en Cemento* \ meuble laqué Cemento \ Möbel lackiert, mit Gestell Cemento* \ Тумбы крашенные со структурой в отделке Cemento *	1642,00	
 140		 +	140 x 48 x h3,5	MUPI140(X)*	22,00	<b>top</b> encimera \ plan \ Holzregal \ столешница <ul style="list-style-type: none"> <li> Gloss White</li> <li> Le Terre di Cielo</li> <li> Le Acque di Cielo</li> </ul>
	140 x 48 x h38		MUMBG140NM(X)*	29,00	<b>lacquered cabinet with framework in Matt Black finish*</b> mueble lacado con estructura en Nero Matt* \ meuble laqué noir mat \ Möbel lackiert, mit Gestell matt Schwarz* \ Тумбы крашенные со структурой в отделке *	1757,00
		MUMBG140CM(X)*	29,00	<b>lacquered cabinet with framework in Cemento finish*</b> mueble lacado con estructura en Cemento* \ meuble laqué Cemento \ Möbel lackiert, mit Gestell Cemento* \ Тумбы крашенные со структурой в отделке Cemento *	1757,00	

	Size (cm) Medidas Dimensions Maße Размеры	Product code Artículo Article Artikel Артикул	Net weight (Kg) Peso neto Poids net Reingewicht вес нетто	Finishes Acabados Finitions Farbe Отделки	Euro Евро
 <p><b>Towel rail (optional)</b> Toallero (opcional) \ porte-serviette (en option) \ Handtuchhalter (fakultativ) \ Полотенцедержатель (опциональный)</p>	48 x 6 x h4	MUPSL(X)*	1,80	 *X = NM - Matt Black	167,00
				 *X = CM - Cemento	167,00
<p><b>Tap/Faucet hole on request</b> (mandatory position – see technical data sheet). \ Orificio grifo a petición (posición obligada-veáse ficha técnica) \ Trou de robinet sur demande (position obligée – voir fiche technique) \ Hinweis: Hahnloch auf Anfrage (Position obligatorisch – siehe technisches Datenblatt) \ Отверстие под смеситель по запросу (возможное место расположения отверстия – проверьте на технической)</p>					25,00

**! mandatory combination: Cielo on top washbasin + top + framework**

combinaison obligatoire: cubela de apoio Cielo + encimera + estructura  
 combinación obligatoria: vasque à poser Cielo + plan + structure  
 obligatorische Kombination: Aufsatzbecken Cielo + Holzregal + gestell  
 обязательное сочетание: Накладная Cielo + столешница + структура

**Terre di Cielo available for ceramic top** / Terre di Cielo disponibles para la encimera de cerámica / Terre di Cielo disponibles pour le plan en céramique / Für Keramikplatte erhältliche Terre di Cielo / Отделку Terre di Cielo доступны для керамических столешниц

-  TL - Talco
-  PM - Pomice
-  BR - Brina
-  BA - Basalto
-  LN - Lino
-  FN - Fango
-  CA - Cacao
-  AN - Arenaria
-  AV - Avena
-  CM - Cemento
-  MU - Muschio
-  AG - Agave
-  PL - Polvere
-  CP - Cipria
-  CN - Canapa
-  LV - Lavagna

**Acque di Cielo available for ceramic top** / Acque di Cielo disponibles para la encimera de cerámica / Acque di Cielo disponibles pour le plan en céramique / Für Keramikplatte erhältliche Acque di Cielo / Отделку Acque di Cielo доступны для керамических столешниц

-  OL - Oltremare
-  SM - Smeraldo
-  AL - Alga
-  CO - Corallo
-  NI - Ninfea
-  AM - Anemone















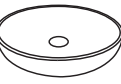





















**\* Terre di Cielo laquering available for cabinet** / lacados Terre di Cielo disponibles para mueble / laquages Terre di Cielo disponibles pour le meuble / Für Möbel erhältliche Lackierungen Terre di Cielo / крашенная отделка Terre di Cielo доступна для ящика и столешницы

-  TL - Talco
-  PM - Pomice
-  BR - Brina
-  AN - Arenaria
-  BA - Basalto
-  MU - Muschio
-  AV - Avena
-  CM - Cemento

**\* coating metal part of cabinet** / pieza metálica pintada / peinture de la partie métallique du meuble / Lackierungen Metallteile des Möbels / Покраска металлических деталей мебели

-  Matt Black
-  Cemento











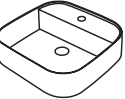



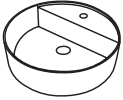























	Size (cm) Medidas Dimensions Maße Размеры	Product code Artículo Article Artikel Артикул	Net weight (Kg) Peso neto Poids net Reingewicht вес нетто	Finishes Acabados \ Finitions Farbe \ Отделки	Euro	Pz. шт. pallet Italia	Pz. шт. pallet Cont.
 <p><b>Shui on top bowl ø40</b> Cubela de apoio ø40 \ Vasque à poser ø40 \ Aufsatzbecken ø40 \ Накладная ø40</p>	ø40 x 18,5 h	SHBA40(X)*	8,55	<ul style="list-style-type: none"> <li> Gloss White</li> <li> Le Terre di Cielo</li> <li> Le Acque di Cielo</li> </ul>	<p>427,00</p> <p>708,00</p> <p>708,00</p>	26	52
 <p><b>Shui on top bowl ø45</b> Cubela de apoio ø45 \ Vasque à poser ø45 \ Aufsatzbecken ø45 \ Накладная ø45</p>	ø45 x 12,5 h	SHBA45(X)*	9,05	<ul style="list-style-type: none"> <li> Gloss White</li> <li> Le Terre di Cielo</li> <li> Le Acque di Cielo</li> </ul>	<p>433,00</p> <p>744,00</p> <p>744,00</p>	32	64
 <p><b>Shui Comfort square washbasin</b> \ Lavabo Shui Comfort cuadrato \ Lavabo Shui Comfort carré \ Aufsatzbecken quadratisch Shui Comfort \ Раковина квадрат Shui Comfort</p>	40 x 40 x 12,5 h	SHCOLAQ40(X)*	7,95	<ul style="list-style-type: none"> <li> Gloss White</li> <li> Le Terre di Cielo</li> <li> Le Acque di Cielo</li> </ul>	<p>472,00</p> <p>757,00</p> <p>757,00</p>	26	52
 <p><b>Shui Comfort round washbasin</b> \ Lavabo Shui Comfort ronda \ Lavabo Shui Comfort tour \ Aufsatzbecken Runde Shui Comfort \ Раковина круглый Shui Comfort</p>	ø40 x 12,5 h	SHCOLAT40(X)*	6,85	<ul style="list-style-type: none"> <li> Gloss White</li> <li> Le Terre di Cielo</li> <li> Le Acque di Cielo</li> </ul>	<p>434,00</p> <p>710,00</p> <p>710,00</p>	26	52
 <p><b>Era on top bowl</b> Cubela de apoio Era \ Vasque à poser Era \ Aufsatzbecken Runde Era \ Раковина круглый Era</p>	ø45 x 24 h	BAERA(X)*	13,00	<ul style="list-style-type: none"> <li> Gloss White</li> <li> Le Terre di Cielo</li> <li> Le Acque di Cielo</li> </ul>	<p>667,00</p> <p>934,00</p> <p>934,00</p>	16	32
 <p><b>Era Small on top bowl</b> Cubela de apoio Era Small \ Vasque à poser Era Small \ Aufsatzbecken Runde Era Small \ Раковина круглый Era Small</p>	ø40 x 15 h	BAERA40(X)*	8,00	<ul style="list-style-type: none"> <li> Gloss White</li> <li> Le Terre di Cielo</li> <li> Le Acque di Cielo</li> </ul>	<p>424,00</p> <p>690,00</p> <p>690,00</p>	26	52
 <p><b>Tina on top bowl</b> Cubela de apoio Tina \ Vasque à poser Tina \ Aufsatzbecken Runde Tina \ Раковина круглый Tina</p>	ø45 x 26 h	BATA(X)*	11,90	<ul style="list-style-type: none"> <li> Gloss White</li> <li> Le Terre di Cielo</li> <li> Le Acque di Cielo</li> </ul>	<p>638,00</p> <p>832,00</p> <p>832,00</p>	16	32
 <p><b>Tino on top bowl</b> Cubela de apoio Tino \ Vasque à poser Tino \ Aufsatzbecken Runde Tino \ Раковина круглый Tino</p>	ø43 x 19 h	BATO(X)*	10,30	<ul style="list-style-type: none"> <li> Gloss White</li> <li> Le Terre di Cielo</li> <li> Le Acque di Cielo</li> </ul>	<p>427,00</p> <p>697,00</p> <p>697,00</p>	26	52
 <p><b>Handy round on top bowl with one hole</b> \ Lavabo Handy ronda con 1 agujero \ Lavabo Handy tour monotrou \ Aufsatzbecken Runde Handy 1-Loch \ Раковина круглый Handy одно отверстие под смеситель</p>	45 x 17 h	HALAT45(X)*	10,50	<ul style="list-style-type: none"> <li> Gloss White</li> <li> Le Terre di Cielo</li> <li> Le Acque di Cielo</li> </ul>	<p>456,00</p> <p>714,00</p> <p>714,00</p>	20	34

### Technical symbols legend

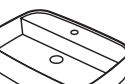
Simbolos técnicos clave | Légende symboles techniques | Technische Zeichenerklärung | Перечень технических символов

 <p><b>all sides are enamelled</b> con todos los lados esmaltados avec tous les côtés émaillés alle Seiten glasiert все стороны покрыты эмалью</p>	 <p><b>no tap holes</b> sin agujero para grifo sans orifice robinet ohne Hahnloch без отверстия под смеситель</p>	 <p><b>without overflow</b> sin rebosadero sans trop-plein ohne Überlauf без слива-перелива</p>	 <p><b>on top installation</b> instalación de apoyo installation à partir du plan Montage auf Platte установка на столешницу</p>	 <p><b>with 1 hole prepared 3 holes</b> avec un trou prédisposition à trois trous mit 1-Loch auf 3-Loch durchschlagbar одно отверстие с возможностью выполнения трех отверстий выполнения пять отверстий, выполнения семь отверстий</p>	 <p><b>one tap hole</b> con 1 agujero monotrou 1-Loch одно отверстие под смеситель</p>
 <p><b>no tap hole on request</b> sin agujero, solo a petición sans orifice sur demande auf Anfrage ohne Loch без отверстия под смеситель по запросу</p>	 <p><b>one side is unglazed</b> con un lado sin esmaltar avec un côté non émaillé eine Seite unglasiert одна сторона не покрыта эмалью</p>	 <p><b>with overflow</b> con rebosadero avec trop-plein mit Überlauf с переливом</p>	 <p><b>wall-hung installation</b> instalación suspendida installation suspendue wandhängende Montage подвесная установка</p>		

	<b>Size (cm)</b> Medidas Dimensions Maße Размеры	<b>Product code</b> Artículo Article Artikel Артикул	<b>Net weight(Kg)</b> Peso neto Poids net Reingewicht вес нетто	<b>Finishes</b> Acabados \ Finitions Farbe \ Отделка	<b>Euro</b> Евро	<b>Pz.</b> шт. pallet Italia	<b>Pz.</b> шт. pallet Cont.
 <p><b>Shui Comfort square washbasin with one hole</b>                      Lavabo Shui Comfort cuadrato con 1 agujero \ Lavabo Shui Comfort carrè monotrou \ Aufsatzbecken quadratisch Shui Comfort 1-Loch \ Раковина квадрат Shui Comfort одно отверстие под смеситель</p>	44 x 43 x 13 h	SHCOLAQF(X)*	9,50	<ul style="list-style-type: none"> <li> <b>Gloss White</b></li> <li> <b>Le Terre di Cielo</b></li> <li> <b>Le Acque di Cielo</b></li> </ul>	503,00 748,00 748,00	20	34
 <p><b>Shui Comfort round washbasin with one hole</b>                      Lavabo Shui Comfort ronda con 1 agujero \ Lavabo Shui Comfort tour monotrou \ Aufsatzbecken Runde Shui Comfort 1-Loch \ Раковина круглый Shui Comfort одно отверстие под смеситель</p>	ø45 x 13 h	SHCOLATF(X)*	8,50	<ul style="list-style-type: none"> <li> <b>Gloss White</b></li> <li> <b>Le Terre di Cielo</b></li> <li> <b>Le Acque di Cielo</b></li> </ul>	485,00 727,00 727,00	20	34
 <p><b>Minimo round washbasin</b>                      Lavabo Minimo round ronda \ Lavabo Minimo tour \ Aufsatzbecken Runde Minimo \ Раковина круглый Minimo</p>	ø25 x 11,5 h	MILAT(X)*	3,15	<ul style="list-style-type: none"> <li> <b>Gloss White</b></li> <li> <b>Le Terre di Cielo</b></li> <li> <b>Le Acque di Cielo</b></li> </ul>	277,00 413,00 413,00	152	304
 <p><b>Minimo square washbasin</b>                      Lavabo Minimo cuadrato ronda \ Lavabo Minimo carrè \ Aufsatzbecken quadratisch Minimo \ Раковина квадрат Minimo</p>	25 x 25 x 11,5 h	MILAQ(X)*	3,15	<ul style="list-style-type: none"> <li> <b>Gloss White</b></li> <li> <b>Le Terre di Cielo</b></li> <li> <b>Le Acque di Cielo</b></li> </ul>	277,00 413,00 413,00	152	304
 <p><b>Eco on top bowl</b>                      Cubela de apoio Eco \ Vasque à poser Eco \ Aufsatzbecken Runde Eco \ Раковина круглый Eco</p>	62 x 45 x 18 h	BAECO(X)*	10,50	<ul style="list-style-type: none"> <li> <b>Gloss White</b></li> <li> <b>Le Terre di Cielo</b></li> <li> <b>Le Acque di Cielo</b></li> </ul>	601,00 840,00 840,00	14	28
 <p><b>Eco Small on top bowl</b>                      Cubela de apoio Eco Small \ Vasque à poser Eco Small \ Aufsatzbecken Runde Eco Small \ Раковина круглый Eco Small</p>	58 x 42 x 16,5 h	BAECO58(X)*	10,00	<ul style="list-style-type: none"> <li> <b>Gloss White</b></li> <li> <b>Le Terre di Cielo</b></li> <li> <b>Le Acque di Cielo</b></li> </ul>	534,00 788,00 788,00	16	32
 <p><b>Shui Comfort oval washbasin</b>                      Lavabo Shui Comfort oval \ Lavabo Shui Comfort ovale \ Aufsatzbecken Oval Shui Comfort \ Раковина овальный Shui Comfort</p>	60 x 38 x 12,5 h	SHCOLAO60(X)*	9,60	<ul style="list-style-type: none"> <li> <b>Gloss White</b></li> <li> <b>Le Terre di Cielo</b></li> <li> <b>Le Acque di Cielo</b></li> </ul>	542,00 852,00 852,00	20	40
 <p><b>Shui Comfort rectangular washbasin</b>                      Lavabo Shui Comfort rectangular \ Lavabo Shui Comfort rectangulaire \ Aufsatzbecken rechteckig Shui Comfort \ Раковина прямоугольная Shui Comfort</p>	60 x 40 x 12,5 h	SHCOLAR60(X)*	10,35	<ul style="list-style-type: none"> <li> <b>Gloss White</b></li> <li> <b>Le Terre di Cielo</b></li> <li> <b>Le Acque di Cielo</b></li> </ul>	566,00 864,00 864,00	20	40
 <p><b>Shui Comfort rectangular washbasin with one hole</b>                      Lavabo Shui Comfort rectangular con 1 agujero \ Lavabo Shui Comfort rectangulaire monotrou \ Aufsatzbecken rechteckig Shui Comfort 1-Loch \ Раковина прямоугольная Shui Comfort одно отверстие под смеситель</p>	60 x 43 x 13 h	SHCOLARF(X)*	14,00	<ul style="list-style-type: none"> <li> <b>Gloss White</b></li> <li> <b>Le Terre di Cielo</b></li> <li> <b>Le Acque di Cielo</b></li> </ul>	605,00 868,00 868,00	20	40

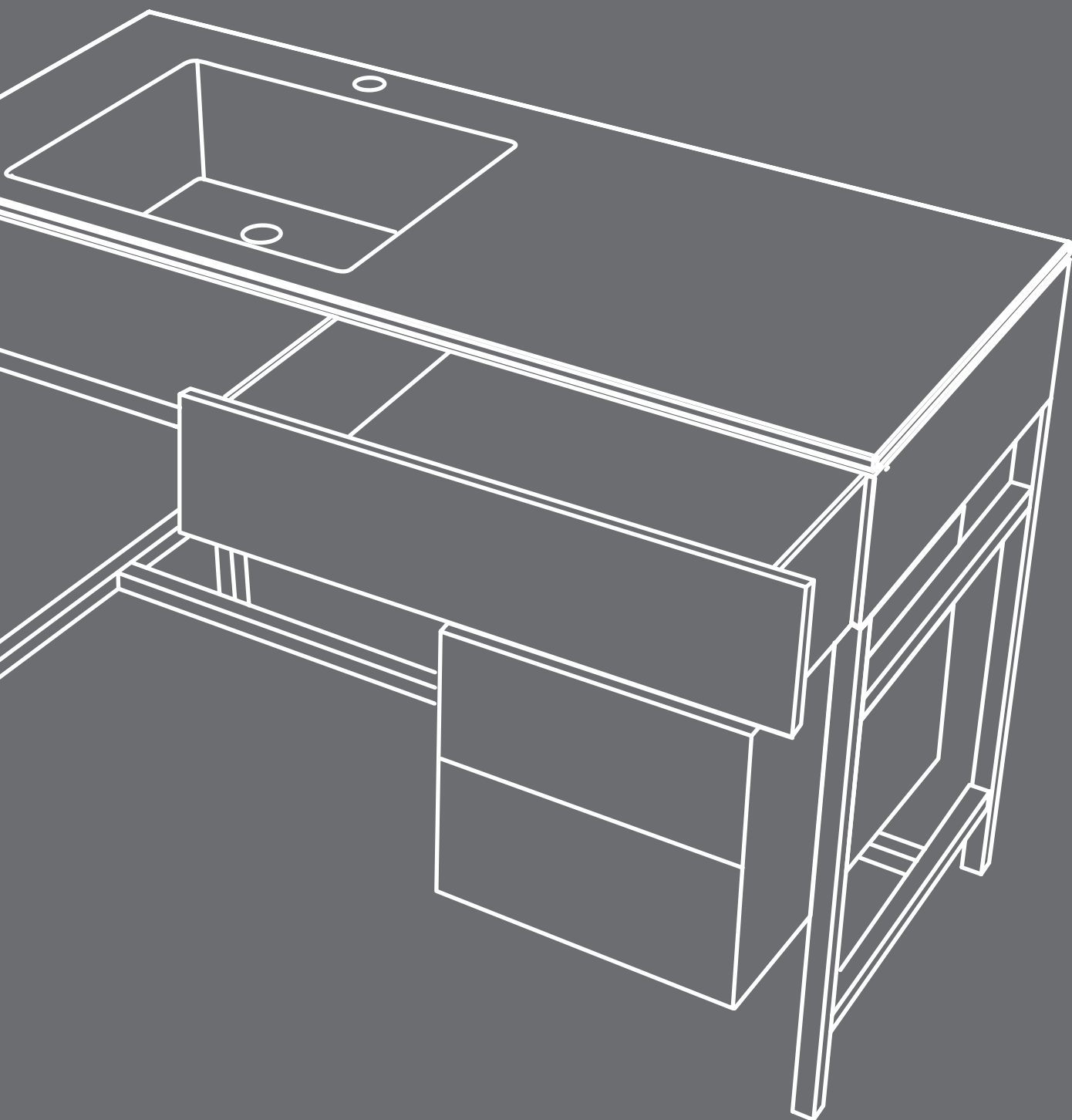

# Milano

design **Andrea Parisio & Giuseppe Pezzano**

QR code configuratore \ configurator pg. 292

indice collezione \ collection index pg. 293

modulo d'ordine \ order form pg. 295

listino prezzi \ price list pg. 296 - 297









## Configure the product directly online and send the order to Cielo.

Configure el producto directamente online y envíe el pedido a Cielo.

Configurez le produit directement en ligne et envoyez la commande à Cielo.

Konfigurieren Sie Ihr Produkt online und schicken Sie die Bestellung direkt an Cielo.

Сконфигурируйте изделие в онлайн и перешлите заказ на фабрику Cielo.

The screenshot displays the 'CONFIGURATORE' interface for the 'Milano' vanity. It features a main product image, a list of color swatches under the heading 'LE TERRE DI CIELO', and a list of components with expandable options. The quantity is set to 1. There are buttons for 'Carica un file', 'Scarica le schede tecniche', and 'SALVA NEL CARRELLO IL PRODOTTO CONFIGURATO'.

EN



go to the  
configurator

SP

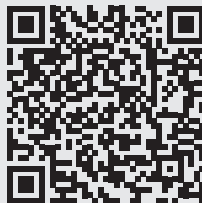

ir al  
configurador

FR

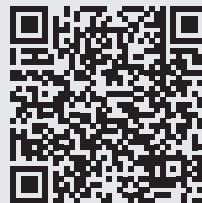

lien vers le  
configurateur

RU



Перейдите в  
конфигуратор

## Lavabo con mobile / washbasin with cabinet

### Milano

120 x 50 x 85 h

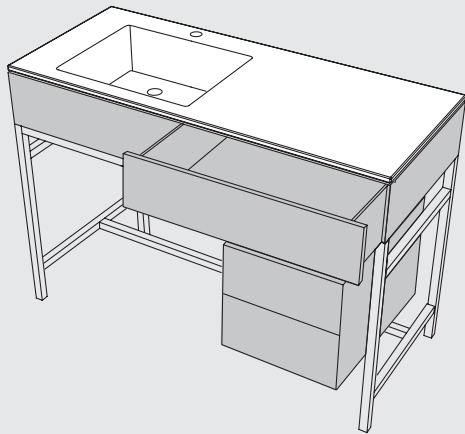

**lavabo + base con cassetto +  
struttura + cassettiera**  
washbasin + drawer + framework +  
drawer unit  
pag. 296

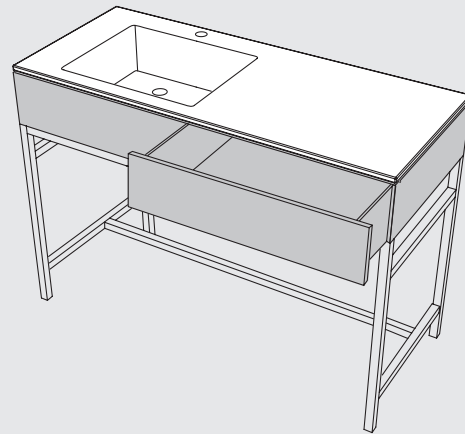

**lavabo + base con cassetto +  
struttura**  
washbasin + drawer + framework  
pag. 296

modelli disponibili / available models

**MILANO**  
collection

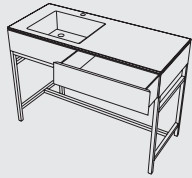

**Milano**  
120 x 50 x 85 h

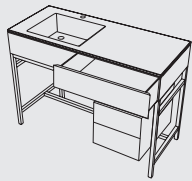

**Milano con cassetiera**  
with drawer unit  
120 x 50 x 85 h



finiture / finishes

LAVABO IN CERAMICA / CERAMIC WASHBASIN

Le Terre di Cielo

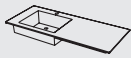

MILA

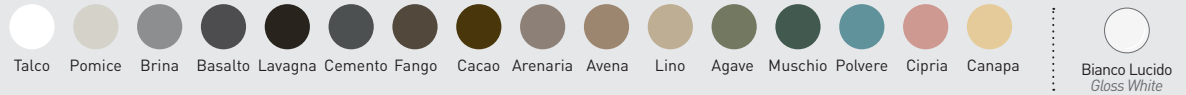

BASE CON CASSETTO IN LEGNO / WOODEN BASE WITH DRAWER

laccature / lacquers

Le Terre di Cielo

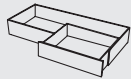

MIBCL  
MIBCE



essenze / wooden finishes

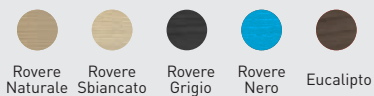

STRUTTURA IN ACCIAIO / STEEL FRAMEWORK

verniciature / coatings

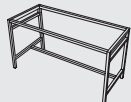

MIST



CASSETTIERA IN LEGNO / WOODEN DRAWER UNIT

laccature / lacquers

Le Terre di Cielo



MICL  
MICE



essenze / wooden finishes

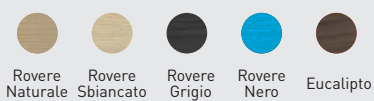

note tecniche lavabo / washbasin technical notes



monoforo predisposto 3 fori  
with 1 hole prepared 3 holes



senza foro su richiesta  
no tap hole on request



senza troppopieno  
without overflow



composizione obbligatoria: lavabo + base + struttura  
mandatory combination: washbasin + drawer + framework

CLIENTE/client:  ORD. REF.:

QUANTITA'/quantity:  EMAIL:

INDICARE CON UN SEGNO LE FINITURE SCELTE PER I DIVERSI COMPONENTI

INDICATE WITH A TICK, THE CHOSEN FINISHES FOR ALL THE COMPONENTS

art. **MILA \ MILASF**

**FINITURE LAVABO**  
WASHBASIN SHELF FINISHES

Bianco/white - glossy

Le Terre di Cielo

<input type="radio"/> TL - Talco	<input type="radio"/> AN - Arenaria
<input type="radio"/> PM - Pomice	<input type="radio"/> AV - Avena
<input type="radio"/> BR - Brina	<input type="radio"/> LN - Lino
<input type="radio"/> BA - Basalto	<input type="radio"/> AG - Agave
<input type="radio"/> LV - Lavagna	<input type="radio"/> MU - Muschio
<input type="radio"/> CM - Cemento	<input type="radio"/> PL - Polvere
<input type="radio"/> FN - Fango	<input type="radio"/> CP - Cipria
<input type="radio"/> CA - Cacao	<input type="radio"/> CN - Canapa

art. **MIBCL / art. MIBCE**

**FINITURE BASE CON CASSETTO**  
WOODEN DRAWER FINISHES

laccature/laquerings (art. MIBCL)

<input type="radio"/> TL - Talco	<input type="radio"/> AV - Avena
<input type="radio"/> PM - Pomice	<input type="radio"/> CM - Cemento
<input type="radio"/> BR - Brina	<input type="radio"/> BA - Basalto
<input type="radio"/> AN - Arenaria	<input type="radio"/> MU - Muschio

essenze legno/wood essences (art. MIBCE)

<input type="radio"/> RG - Rovere Grigio	<input type="radio"/> RO - Rovere Nero
<input type="radio"/> RS - Rovere Sbiancato	<input type="radio"/> EU - Eucalipto
<input type="radio"/> RN - Rovere Naturale	

art. **MICL / art. MICE** YES  NO

**FINITURE CASSETTIERA**  
DRAWER FINISHES

laccature/laquerings (art. MICL)

<input type="radio"/> TL - Talco	<input type="radio"/> AV - Avena
<input type="radio"/> PM - Pomice	<input type="radio"/> CM - Cemento
<input type="radio"/> BR - Brina	<input type="radio"/> BA - Basalto
<input type="radio"/> AN - Arenaria	<input type="radio"/> MU - Muschio

essenze legno/wood essences (art. MICE)

<input type="radio"/> RG - Rovere Grigio	<input type="radio"/> RO - Rovere Nero
<input type="radio"/> RS - Rovere Sbiancato	<input type="radio"/> EU - Eucalipto
<input type="radio"/> RN - Rovere Naturale	

art. **MIST**

**FINITURE STRUTTURA**  
FRAMEWORK FINISHES

verniciature\_coatings

<input type="radio"/> NM - Nero Matt
<input type="radio"/> BZ - Bronzo Spazzolato
<input type="radio"/> CM - Cemento

**N.B. Il lavabo è monoforo predisposto 3 fori, su richiesta può essere prodotto senza foro**

*N.B. The washbasin has 1 hole prepared 3 holes ; may be made without holes upon request*

DATA  
DATE

FIRMA DEL CLIENTE  
SIGNATURE

ATTENZIONE:  
La rappresentazione delle finiture è puramente indicativa. Verificare le finiture con le relative cartelle.











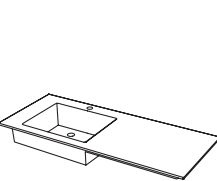

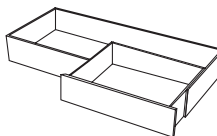







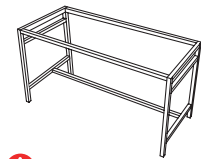

Ogni oggetto possiede la peculiarità di essere elaborato secondo principi puramente tradizionali, in modo da garantirne l'assoluta originalità ed unicità. Le eventuali piccole variazioni di colore, tono o venature fra gli articoli sono da considerarsi pregi e non difetti, in quanto garanzia della fattura manuale del prodotto, che fa di ogni oggetto Cielo un pezzo unico ed esclusivo, lontano dall'omologazione industriale. In fase d'ordine si intendono, pertanto, accettate tali tolleranze che non possono dare adito a contestazioni di alcun genere.

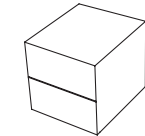
Verificare sempre le disponibilità e i tempi di consegna con il commerciale.

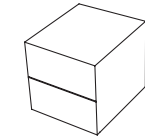



















ATTENTION:  
The representation of the finishes is merely indicative. Please choose the finishes using the folders.

Every item possesses that particular feature of being processed according to purely traditional principles that guarantee its absolute originality and uniqueness. The small variations in colour, hues or streaks on the items are to be considered as qualities and not defects, since they warranty the handcrafted processing which makes each Cielo item a unique and exclusive piece that cannot be compared to industrial standardization. When making the order, the client implicitly accepts those various features that may give rise to claims of any sort.

Always check the availability and delivery time with the commercial department.

	<b>Size (cm)</b> Medidas Dimensions Maße Размеры	<b>Product code</b> Artículo Article Artikel Артикул	<b>Net weight (Kg)</b> Peso neto Poids net Reingewicht вес нетто	<b>Finishes</b> Acabados Finitions Farbe Отделки	<b>Euro</b> Евро	<b>Pz.</b> шт. pallet Italia	<b>Pz.</b> шт. pallet Cont.
	120 x 50						
 <p><b>Ceramic washbasin with 1 hole</b>                      Lavabo de cerámica monoagujero                      Lavabo en céramique avec un trou                      Waschbecken aus Keramik mit 1 Hahnloch                      Керамическая раковина на одно отверстие</p>	120 x 50 x 20 h	MILA(x)*  MILASF(x)* <b>no tap hole</b> sin agujero sans orifice ohne Loch без отверстия	34,00	 <b>Gloss White</b>   <b>Le Terre di Cielo</b>	1038,00  1389,00		
<p>+</p>  <p><b>Lacquered drawer</b>                      Base con cajón lacado                      Tiroir laqué                      Schubfach lackiert                      Консоль с крашенным ящиком</p>	120 x 50 x 18 h	MIBCL(x)*	17,00	 <b>Le Terre di Cielo*</b>	1041,00		
<p>!</p>  <p><b>Drawer in wooden finish</b>                      Base con cajón en madera                      Tiroir en bois                      Holzschubfach                      Консоль с ящиком с отделкой натуральным шпоном</p>	120 x 50 x 18 h	MIBCE(x)*	17,00	<b>EsSENze</b>  *X = RN - Rovere Naturale  *X = RS - Rovere Sbiancato  *X = RO - Rovere Nero  *X = RG - Rovere Grigio   *X = EU - Eucalipto	1238,00  1425,00		
<p>!</p>  <p><b>Steel framework</b>                      Estructura de acero                      Structure en acier                      Stahlgestell                      Стальной каркас</p>	120 x 50 x 65,5 h	MIST(x)*	13,00	 *X = NM <b>Matt Black</b>   *X = BZ <b>Brushed Bronze</b>   *X = CM <b>Cemento</b>	984,00  1504,00  984,00		
 <p><b>Lacquered drawer unit</b>                      Cajonera lacada                      Commode laqué                      Schubladenelement lackiert                      Крашеная тумба</p>	48 x 45 x 42 h	MICL(x)*	22,00	 <b>Le Terre di Cielo*</b>	1103,00		
 <p><b>Drawer unit in wooden finish</b>                      Cajonera en madera                      Commode en bois                      Schubladenelement                      Тумба с отделкой натуральным шпоном</p>	48 x 45 x 42 h	MICE(x)*	22,00	<b>EsSENze</b>  *X = RN - Rovere Naturale  *X = RS - Rovere Sbiancato  *X = RO - Rovere Nero  *X = RG - Rovere Grigio   *X = EU - Eucalipto	1281,00  1540,00		

! **Mandatory combination: washbasin + drawer + framework**  
 combinaison obligatoire: lavabo + base + structure  
 Combinación obligatoria: lavabo + base + estructura  
 obligatorische Kombination: Waschbecken + Unterbau + Gestell  
 обязательное сочетание: раковина + тумба + каркас

	Product code Artículo Article Artikel Артикул	Net weight <sub>(kg)</sub> Peso neto Poids net Reingewicht вес нетто	Finishes Acabados Finitions Farbe Отделки	Euro Евро
 <p><b>Universal click/clack drain in CHROME with ceramic lid</b> Válvula universal click/clack Cromado con tapa en cerámica Bonde universelle clic/clac Chromé avec clapet en céramique Universal-Ablaufgarnitur Click-Clack Chrom mit Keramikstopfen Универсальный донный клапан click/clack хром с керамической крышкой</p>	PIL01(X)*	0,40	 <b>Gloss White</b>	<b>95,00</b>
			 <b>Le Terre di Cielo</b>	<b>139,00</b>
 <p><b>Universal click/clack drain in BLACK MATT finish with ceramic lid</b> Válvula universal click/clack Negro Matt con tapa en cerámica Bonde universelle clic/clac Noir Mat avec clapet en céramique Universal-Ablaufgarnitur Click-Clack Matt Schwarz mit Keramikstopfen Универсальный донный клапан click/clack черный матовый с керамической крышкой</p>	PIL01NM(X)*	0,40	 <b>Gloss White</b>	<b>120,00</b>
			 <b>Le Terre di Cielo</b>	<b>169,00</b>
 <p><b>Universal click/clack drain in CEMENTO finish with ceramic lid</b> Válvula universal click/clack Cemento con tapa en cerámica Bonde universelle clic/clac Cemento avec clapet en céramique Universal-Ablaufgarnitur Click-Clack Cement mit Keramikstopfen Универсальный донный Cemento click/clack с керамической крышкой</p>	PIL01CM(X)*	0,40	 <b>Gloss White</b>	<b>120,00</b>
			 <b>Le Terre di Cielo</b>	<b>169,00</b>
 <p><b>Universal click/clack drain in BRONZE with ceramic lid</b> Válvula universal click/clack Bronce con tapa en cerámica Bonde universelle clic/clac Bronce avec clapet en céramique Universal-Ablaufgarnitur Click-Clack Bronze mit Keramikstopfen Универсальный донный клапан click/clack бронза с керамической крышкой</p>	PIL01BR(X)*	0,40	 <b>Gloss White</b>	<b>135,00</b>
			 <b>Le Terre di Cielo</b>	<b>182,00</b>
 <p><b>CHROMED siphon</b> Sifone Cromado \ Siphon Chromé \ Siphon Verchromt \ сифон Chrome</p>	SISP	0,93	 <b>Chrome</b>	<b>133,00</b>
 <p><b>MATT BLACK siphon</b> Sifone Negro Mate \ Siphon Noir Mat \ Siphon Schwarz Matt \ Сифон Черный матовый</p>	SIFN	0,93	 <b>Matt Black</b>	<b>194,00</b>
 <p><b>CEMENTO siphon</b> Sifone Cemento \ Siphon Cemento \ Siphon Cemento \ сифон Cemento</p>	SIFCM	0,93	 <b>Cemento</b>	<b>194,00</b>
 <p><b>BRONZE siphon</b> Sifone Bronce \ Siphon Bronze \ Siphon Bronze \ бронза сифон</p>	SIFBR	0,93	 <b>Bronze</b>	<b>220,00</b>

With the installation of the drawer, we recommend matching it with our SISP - SIFN - SIFCM - SIFBR siphons/traps / Con la instalación del cajón aconsejamos de combinar nuestros sifones SISP- SIFN-SIFCM-SIFBR / Terre di Cielo disponibles pour les lavabos et le plan en céramique / Bei Montage der Schublade empfehlen wir unsere Siphons SISP - SIFN - SIFCM - SIFBR / При установке ящика рекомендуем сочетать наши сифоны SISP - SIFN - SIFCM - SIFBR

Terre di Cielo available for ceramic washbasin / Terre di Cielo disponibles para lavabo de cerámica / Terre di Cielo disponibles pour les lavabos en céramique / Für Waschbecken erhältliche Terre di Cielo / Отделки Terre di Cielo доступны для раковин и керамических столешниц

-  TL - Talco
-  PM - Pomice
-  BR - Brina
-  BA - Basalto
-  LN - Lino
-  FN - Fango
-  CA - Cacao
-  AN - Arenaria
-  AV - Avena
-  CM - Cemento
-  MU - Muschio
-  AG - Agave
-  PL - Polvere
-  CP - Cipria
-  CN - Canapa
-  LV - Lavagna

\* Terre di Cielo laquering available for drawer / lacados Terre di Cielo disponibles para cajones / laquages Terre di Cielo disponibles pour le tiroir / Für die Schublade erhältliche Lackierungen Terre di Cielo / крашенная отделка Terre di Cielo доступна для ящика

-  TL - Talco
-  PM - Pomice
-  BR - Brina
-  AN - Arenaria
-  BA - Basalto
-  MU - Muschio
-  AV - Avena
-  CM - Cemento

Technical symbols legend / Símbolos técnicos clave / Légende symboles techniques / Technische Zeichenerklärung / Перечень технических символов

- 

**with 1 hole prepared 3 holes**  
con 1 agujero pre-dispuesto para 3  
avec un trou prédisposition à trois trous  
mit 1-Loch auf 3-Loch durchschlagbar  
одно отверстие с возможностью  
выполнения трех отверстий
- 

**no tap hole on request**  
sin agujero; solo a petición  
sans orifice sur demande  
auf Anfrage ohne Loch  
без отверстия под смеситель  
по запросу
- 

**without overflow**  
sin rebosadero  
sans trop-plein  
ohne Überlauf  
без слива-перелива



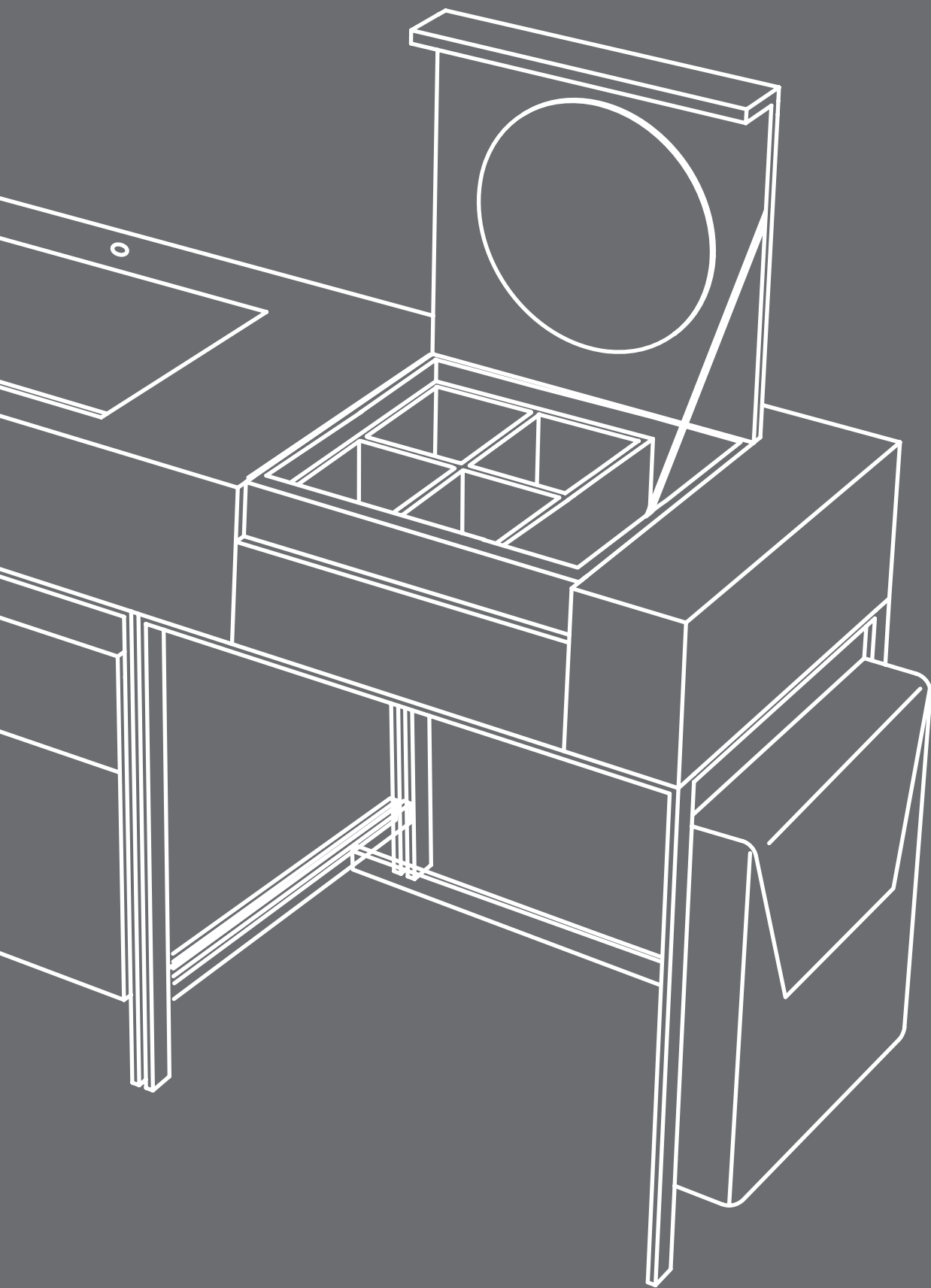

# I Narcisi

design **Andrea Parisio & Giuseppe Pezzano**

## **NARCISO VANITY**

- QR code configuratore \ configurator pg. 302
- indice collezione \ collection index pg. 303
- modulo d'ordine \ order form pg. 305
- listino prezzi \ price list pg. 316 - 317

## **NARCISO MINI**

- QR code configuratore \ configurator pg. 306
- indice collezione \ collection index pg. 307
- modulo d'ordine \ order form pg. 311
- listino prezzi \ price list pg. 318 - 319

## **NARCISO DOPPIO**

- QR code configuratore \ configurator pg. 312
- indice collezione \ collection index pg. 313
- modulo d'ordine \ order form pg. 315
- listino prezzi \ price list pg. 320 - 321





## Configure the product directly online and send the order to Cielo.

Configure el producto directamente online y envíe el pedido a Cielo.  
 Configurez le produit directement en ligne et envoyez la commande à Cielo.  
 Konfigurieren Sie Ihr Produkt online und schicken Sie die Bestellung direkt an Cielo.  
 Сконфигурируйте изделие в онлайн и перешлите заказ на фабрику Cielo.

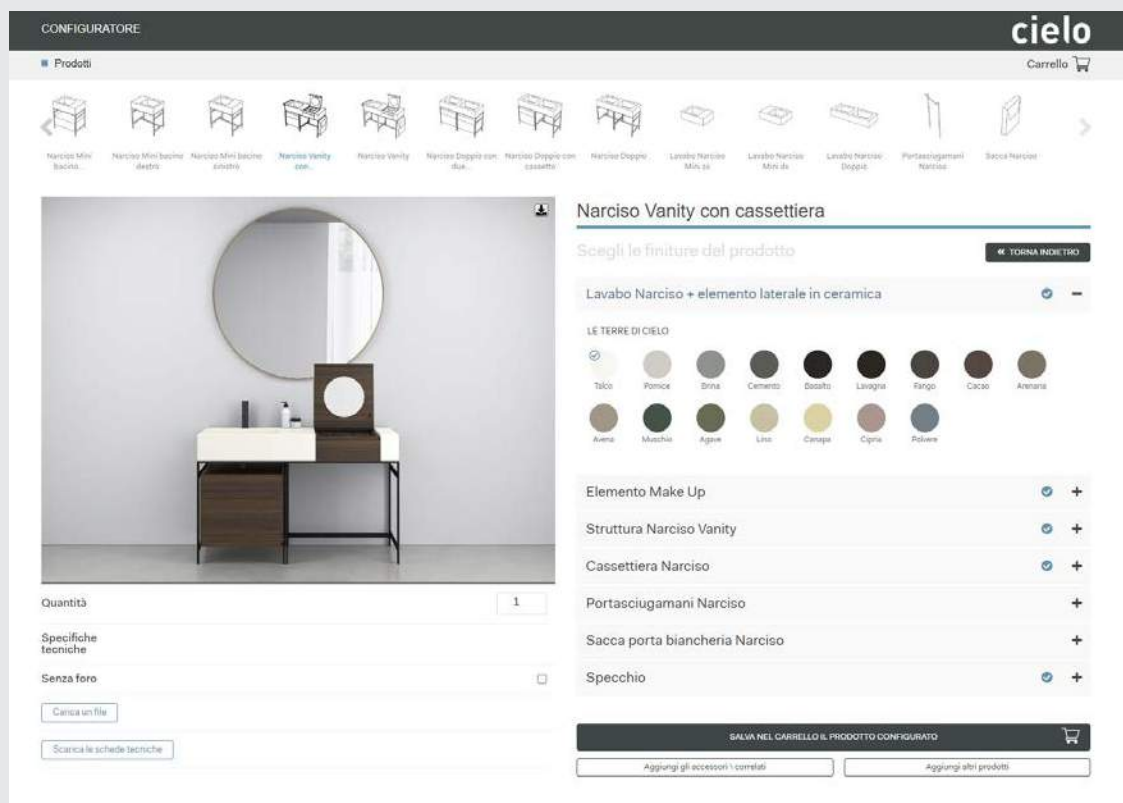

EN

SP

FR

RU

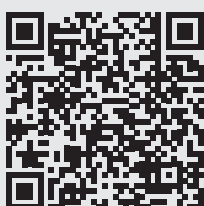

go to the  
configurator



ir al  
configurador

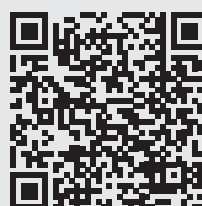

lien vers le  
configurateur



Перейдите в  
конфигуратор



## Lavabo con mobile / washbasin with cabinet

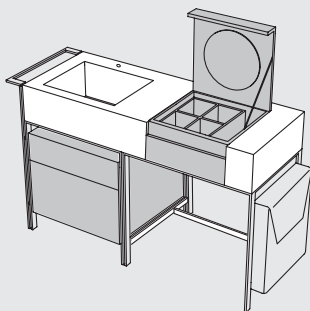

### NARCISO VANITY

**lavabo + struttura + make up + cassettera + portasciugamani + sacca**

washbasin + framework + make up + drawer unit + towel rail + laundry bag  
130 x 50 x 83 h  
pag. 316

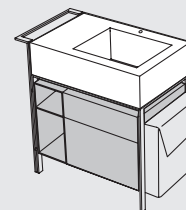
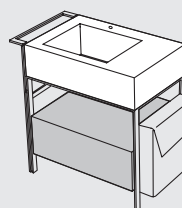
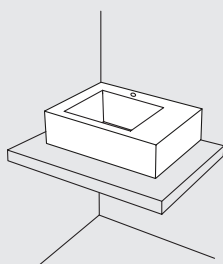
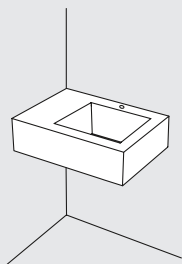

### NARCISO MINI

**lavabo, installazione sospesa**  
washbasin, wall-hung installation  
76 x 50 x 16,5 h  
pag. 318

**lavabo, installazione da piano**  
washbasin, on top installation  
76 x 50 x 16,5 h  
pag. 318

**lavabo + cassetto + struttura + sacca + portasciugamani**  
washbasin + drawer + framework + laundry bag + towel rail  
76 x 50 x 83 h  
pag. 318

**lavabo + cassettera + box + struttura + sacca + portasciugamani**  
washbasin + drawer unit + box + framework + laundry bag + towel rail  
76 x 50 x 83 h  
pag. 318

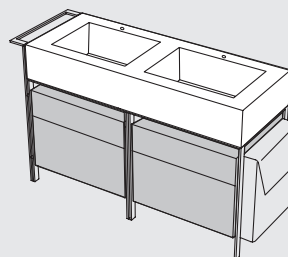
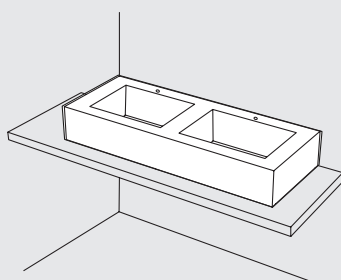
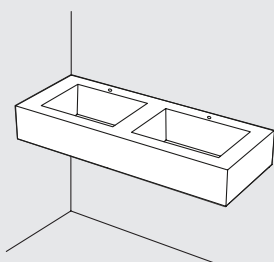

### NARCISO DOPPIO

**lavabo, installazione sospesa**  
washbasin, wall-hung installation  
113 x 50 x 16,5 h  
pag. 320

**lavabo, installazione da piano**  
washbasin, on top installation  
113 x 50 x 16,5 h  
pag. 320

**lavabo + cassettera + struttura + sacca + portasciugamani**  
washbasin + drawer + framework + towel rail  
113 x 50 x 83 h  
pag. 320





modelli disponibili / available models

## NARCISO VANITY collection

**Narciso**  
130 x 50 x 83 h



**Narciso con cassettera**  
with drawer unit

130 x 50 x 83 h



finiture / finishes

### LAVABO IN CERAMICA / CERAMIC WASHBASIN

Le Terre di Cielo

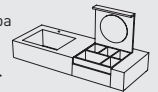

### ELEMENTO "MAKE UP" IN LEGNO / WOODEN "MAKE UP" ELEMENT

essenze / wooden finishes

laccature / lacquers

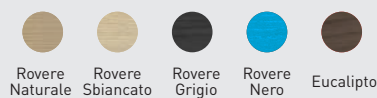

Le Terre di Cielo



NALA + NAMUL

### SACCA PORTABIANCHERIA IN CUOIO / LEATHER LAUNDRY BAG



NASC

### PORTASCIUGAMANI IN ACCIAIO / STEEL TOWEL RAIL

verniciature / coatings

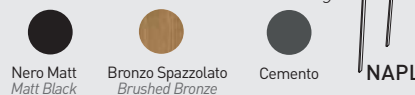

NAPL

### STRUTTURA IN ACCIAIO / STEEL FRAMEWORK

verniciature / coatings

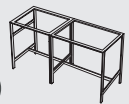

NAST

### CASSETTIERA IN LEGNO / WOODEN DRAWER UNIT

essenze / wooden finishes

laccature / lacquers

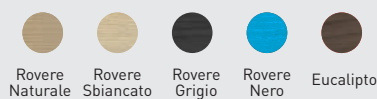

Le Terre di Cielo



NACL / NACE

### note tecniche lavabo / washbasin technical notes



monoforo predisposto 3 fori  
with 1 hole prepared 3 holes



senza foro su richiesta  
no tap hole on request



senza troppopieno  
without overflow



composizione obbligatoria: lavabo + elemento "Make Up" + struttura  
mandatory combination: washbasin + "Make Up" element + framework

# Modulo Ordine Narciso Vanity

Narciso Order Form

**cielo**  
handmade in Italy

CLIENTE/client:  ORD. REF.:

QUANTITA'/quantity:  EMAIL:

INDICARE CON UN SEGNO LE FINITURE SCELTE PER I DIVERSI COMPONENTI

INDICATE WITH A TICK, THE CHOSEN FINISHES FOR ALL THE COMPONENTS

art. **NALA \ NALASF**

### FINITURE LAVABO

WASHBASIN SHELF FINISHES

Le Terre di Cielo

- |                                    |                                     |
|------------------------------------|-------------------------------------|
| <input type="radio"/> TL - Talco   | <input type="radio"/> AN - Arenaria |
| <input type="radio"/> PM - Pomice  | <input type="radio"/> AV - Avena    |
| <input type="radio"/> BR - Brina   | <input type="radio"/> LN - Lino     |
| <input type="radio"/> BA - Basalto | <input type="radio"/> AG - Agave    |
| <input type="radio"/> LV - Lavagna | <input type="radio"/> MU - Muschio  |
| <input type="radio"/> CM - Cemento | <input type="radio"/> PL - Polvere  |
| <input type="radio"/> FN - Fango   | <input type="radio"/> CP - Cipria   |
| <input type="radio"/> CA - Cacao   | <input type="radio"/> CN - Canapa   |

art. **NAMUL / art. NAMUE**

### FINITURE ELEMENTO MAKE-UP

WOODEN MAKE-UP FINISHES

laccature/laquerings (art. NAMUL)

- |                                     |                                    |
|-------------------------------------|------------------------------------|
| <input type="radio"/> TL - Talco    | <input type="radio"/> AV - Avena   |
| <input type="radio"/> PM - Pomice   | <input type="radio"/> CM - Cemento |
| <input type="radio"/> BR - Brina    | <input type="radio"/> BA - Basalto |
| <input type="radio"/> AN - Arenaria | <input type="radio"/> MU - Muschio |

essenze legno/wood essences (art. NAMUE)

- |   |  |
|---|--|
| <input type="radio"/> RG - Rovere Grigio    | <input type="radio"/> RO - Rovere Nero |
| <input type="radio"/> RS - Rovere Sbiancato | <input type="radio"/> EU - Eucalipto   |
| <input type="radio"/> RN - Rovere Naturale  |  |

art. **NAPL**

YES  NO

### FINITURA METALLICA

METAL FINISHES

- |  |
|--|
| <input type="radio"/> NM - Nero Matt         |
| <input type="radio"/> BZ - Bronzo Spazzolato |
| <input type="radio"/> CM - Cemento           |

art. **NACL / art. NACE**

### FINITURE BASE CON CASSETTO

WOODEN DRAWER FINISHES

laccature/laquerings (art. NACL)

- |                                     |                                    |
|-------------------------------------|------------------------------------|
| <input type="radio"/> TL - Talco    | <input type="radio"/> AV - Avena   |
| <input type="radio"/> PM - Pomice   | <input type="radio"/> CM - Cemento |
| <input type="radio"/> BR - Brina    | <input type="radio"/> BA - Basalto |
| <input type="radio"/> AN - Arenaria | <input type="radio"/> MU - Muschio |

essenze legno/wood essences (art. NACE)

- |   |  |
|---|--|
| <input type="radio"/> RG - Rovere Grigio    | <input type="radio"/> RO - Rovere Nero |
| <input type="radio"/> RS - Rovere Sbiancato | <input type="radio"/> EU - Eucalipto   |
| <input type="radio"/> RN - Rovere Naturale  |  |

art. **NASC**

YES  NO

### SACCA IN CUOIO

LEATHER LAUNDRY BAG

- |  |
|--|
| <input type="radio"/> NA - Cuio Naturale |
| <input type="radio"/> NE - Nero          |

art. **NAST**

### FINITURE STRUTTURA

FRAMEWORK FINISHES

verniciature\_coatings

- |  |
|--|
| <input type="radio"/> NM - Nero Matt         |
| <input type="radio"/> BZ - Bronzo Spazzolato |
| <input type="radio"/> CM - Cemento           |

**N.B. Il lavabo è monoforo predisposto 3 fori, su richiesta può essere prodotto senza foro**

*N.B. The washbasin has 1 hole prepared 3 holes ; may be made without holes upon request*

DATA

DATE

FIRMA DEL CLIENTE

SIGNATURE

ATTENZIONE:

La rappresentazione delle finiture è puramente indicativa. Verificare le finiture con le relative cartelle.

Ogni oggetto possiede la peculiarità di essere elaborato secondo principi puramente tradizionali, in modo da garantirne l'assoluta originalità ed unicità. Le eventuali piccole variazioni di colore, tono o venature fra gli articoli sono da considerarsi pregi e non difetti, in quanto garanzia della fattura manuale del prodotto, che fa di ogni oggetto Cielo un pezzo unico ed esclusivo, lontano dall'omologazione industriale. In fase d'ordine si intendono, pertanto, accettate tali tolleranze che non possono dare adito a contestazioni di alcun genere.

Verificare sempre le disponibilità e i tempi di consegna con il commerciale.

ATTENTION:

The representation of the finishes is merely indicative. Please choose the finishes using the folders.

Every item possesses that particular feature of being processed according to purely traditional principles that guarantee its absolute originality and uniqueness. The small variations in colour, hues or streaks on the items are to be considered as qualities and not defects, since they warranty the handcrafted processing which makes each Cielo item a unique and exclusive piece that cannot be compared to industrial standardization. When making the order, the client implicitly accepts those various features that may give rise to claims of any sort.

Always check the availability and delivery time with the commercial department.

## Configure the product directly online and send the order to Cielo.

Configure el producto directamente online y envíe el pedido a Cielo.

Configurez le produit directement en ligne et envoyez la commande à Cielo.

Konfigurieren Sie Ihr Produkt online und schicken Sie die Bestellung direkt an Cielo.

Сконфигурируйте изделие в онлайн и перешлите заказ на фабрику Cielo.

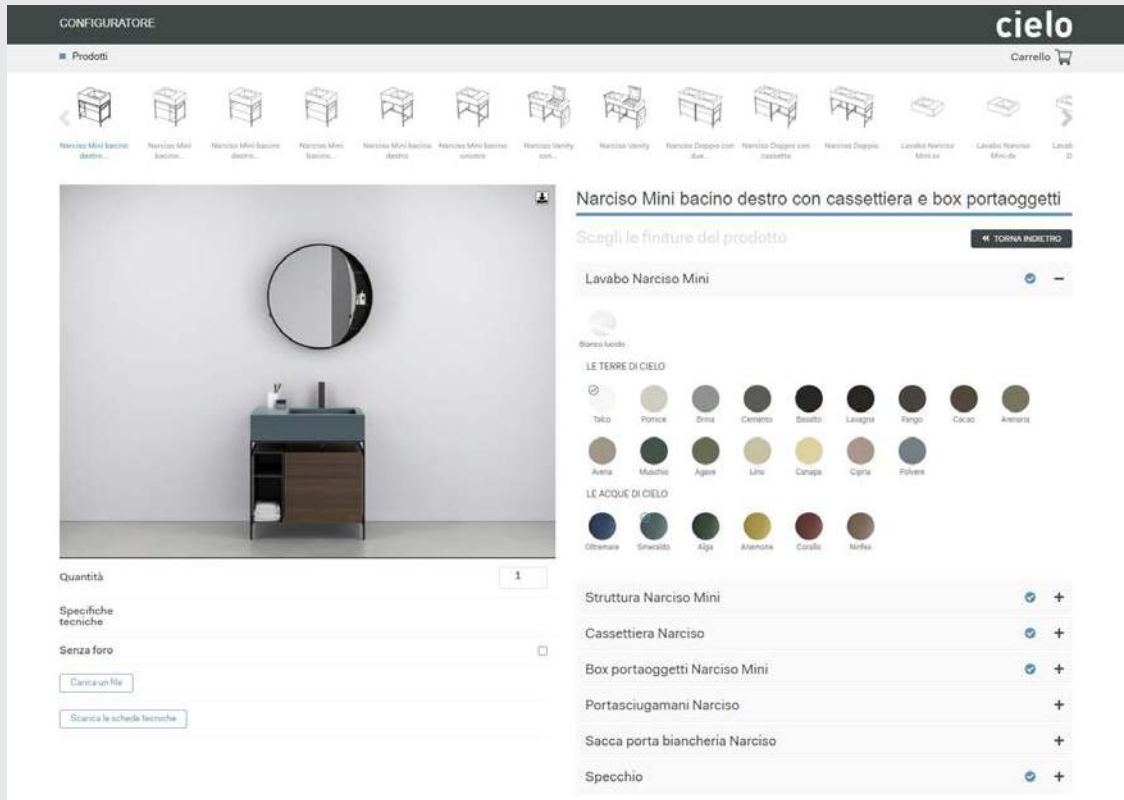

EN

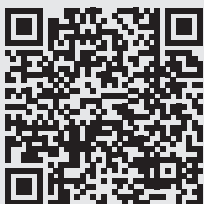

go to the  
configurator

SP

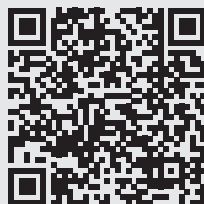

ir al  
configurador

FR



lien vers le  
configurateur

RU



Перейдите в  
конфигуратор

## Narciso Mini

76 x 50

### ceramic left washbasin, on top or wall-hung installation

lavabo de cerámica con seno izquierda, instalación suspendida o de apoyo / lavabo en céramique, vasque à gauche, installation suspendu ou à poser / Waschbecken aus Keramik mit 1 Hahnloch, Becken links, hängender oder Aufputz Installation / Керамическая раковина с 1-им отверстием, чаша слева, приостановленная или поддерживаемая установка

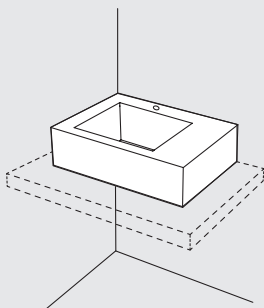

### ceramic right washbasin, on top or wall-hung installation

lavabo de cerámica con seno derecha, instalación suspendida o de apoyo / lavabo en céramique, vasque à droite, installation suspendu ou à poser / Waschbecken aus Keramik mit 1 Hahnloch, Becken rechts, hängender oder Aufputz Installation / Керамическая раковина с 1-им отверстием, чаша справа, приостановленная или поддерживаемая установка

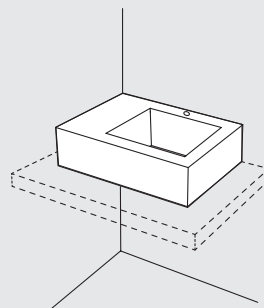

### left washbasin with framework and towel rail (right - left)

lavabo de cerámica con seno izquierda, con estructura y barra para toallasa / lavabo en céramique, vasque à gauche, avec structure, porte-serviettes / Waschbecken aus Keramik mit 1 Hahnloch, Becken links, mit Stahlgestell, Handtuchhalter / Керамическая раковина с 1-им отверстием, чаша слева и Стальной каркас, полотенцесушитель

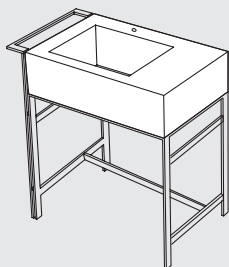

### right washbasin with framework and towel rail (right - left)

lavabo de cerámica con seno derecha, con estructura y barra para toallasa / lavabo en céramique, vasque à droite, avec structure, porte-serviettes / Waschbecken aus Keramik mit 1 Hahnloch, Becken rechts, mit Stahlgestell, Handtuchhalter / Керамическая раковина с 1-им отверстием, чаша справа и Стальной каркас, полотенцесушитель

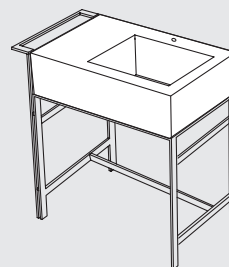

### left washbasin with framework, drawer, towel rail and laundry bag (right - left)

lavabo de cerámica con seno izquierda, con estructura, cajón, barra para toallasa y bolsa / lavabo en céramique, vasque à gauche, avec structure, tiroir en bois, porte-serviettes et sac à linge en cuir véritable / Waschbecken aus Keramik mit 1 Hahnloch, Becken links, mit Stahlgestell, Holzschubfach, Handtuchhalter und Wäschetasche aus Leder / Керамическая раковина с 1-им отверстием, чаша слева и Стальной каркас, полотенцесушитель, Ящик с отделкой натуральным шпоном, Мешок для белья из кожи

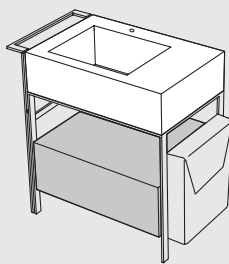

### right washbasin with framework, drawer, towel rail and laundry bag (right - left)

lavabo de cerámica con seno derecha, con estructura, cajón, barra para toallasa y bolsa / lavabo en céramique, vasque à droite, avec structure, tiroir en bois, porte-serviettes et sac à linge en cuir véritable / Waschbecken aus Keramik mit 1 Hahnloch, Becken rechts, mit Stahlgestell, Holzschubfach, Handtuchhalter und Wäschetasche aus Leder / Керамическая раковина с 1-им отверстием, чаша справа и Стальной каркас, полотенцесушитель, Ящик с отделкой натуральным шпоном, Мешок для белья из кожи

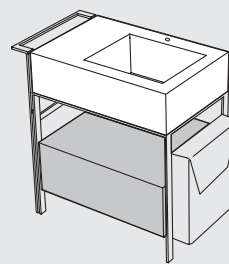

### left washbasin with framework, drawer unit, storage box and laundry bag and towel rail (left - right)

lavabo de cerámica con seno izquierda, con estructura, cajonera, box porta objetos, barra para toallasa y bolsa / lavabo en céramique, vasque à gauche, avec structure, commode, compartiment de rangement, sac à linge en cuir véritable et porte-serviettes / Waschbecken aus Keramik mit 1 Hahnloch, Becken links, mit Stahlgestell, Schubladenelement, Ablagebox, Wäschetasche aus Leder und Handtuchhalter / Керамическая раковина с 1-им отверстием, чаша слева и Стальной каркас, полотенцесушитель, Тумба с отделкой натуральным шпоном, Металлическая база с открытыми отделениями, Мешок для белья из кожи

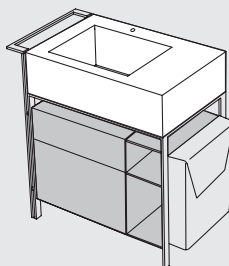

### right washbasin with framework, drawer unit, storage box, laundry bag and towel rail (left-right)

lavabo de cerámica con seno derecha, con estructura, cajonera, box porta objetos, barra para toallasa y bolsa / lavabo en céramique, vasque à droite, avec structure, commode, compartiment de rangement, sac à linge en cuir véritable et porte-serviettes / Waschbecken aus Keramik mit 1 Hahnloch, Becken rechts, mit Stahlgestell, mit Stahlgestell, Schubladenelement, Ablagebox, Wäschetasche aus Leder und Handtuchhalter / Керамическая раковина с 1-им отверстием, чаша справа и Стальной каркас, полотенцесушитель, Тумба с отделкой натуральным шпоном, Металлическая база с открытыми отделениями, Мешок для белья из кожи

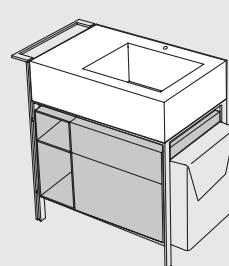







modelli disponibili / available models

## NARCISO MINI collection

**Narciso Mini con  
cassettiera e box porta  
oggetti**  
Narciso Mini with drawer  
unit and storage box  
**76 x 50 x 83 h**



finiture / finishes

**LAVABO IN CERAMICA / CERAMIC WASHBASIN**  
**Le Terre di Cielo**

Talco Pomice Brina Basalto Lavagna Cemento Fango Cacao Arenaria Avena Lino Agave Muschio Polvere Cipria Canapa

Bianco Lucido  
Gloss White

**NALAMSX**

**Le Acque di Cielo**

Oltremare Smeraldo Alga Corallo Ninfea Anemone

**NALAMDX**

**PORTASCIUGAMANI IN ACCIAIO / STEEL TOWEL RAIL**  
verniciature / coatings

Nero Matt  
Matt Black

Bronzo Spazzolato  
Brushed Bronze

Cemento

**NAPL**

**STRUTTURA IN ACCIAIO / STEEL FRAMEWORK**  
verniciature / coatings

Nero Matt  
Matt Black

Bronzo Spazzolato  
Brushed Bronze

Cemento

**NASTM**

**SACCA PORTABIANCHERIA IN CUOIO / LEATHER LAUNDRY BAG**

Nero

Cuoio  
Naturale

**NASC**

**BOX PORTAOGGETTI IN ACCIAIO / STEEL STORAGE BOX**

verniciature / coatings

Nero Matt  
Matt Black

Bronzo Spazzolato  
Brushed Bronze

Cemento

**NABOX**

essenze / wooden finishes

Rovere Naturale

Rovere Sbiancato

Rovere Grigio

Rovere Nero

Eucalipto

**CASSETTIERA IN LEGNO / WOODEN DRAWERS**  
laccature / lacquers

**Le Terre di Cielo**

Talco Pomice Brina Arenaria Avena Cemento Basalto Muschio

**NACL / NACE**

note tecniche lavabo / washbasin technical notes

**monoforo predisposto 3 fori**  
with 1 hole prepared 3 holes

**senza foro su richiesta**  
no tap hole on requeste

**senza troppopieno**  
without overflow

**con un lato non smaltato**  
one side is unglazed

**installazione da piano**  
on top installation

**installazione sospesa**  
wall-hung installation



modelli disponibili / available models

## NARCISO MINI

collection



**Narciso Mini con cassetto basso**  
Narciso Mini with drawer  
76 x 50 x 83 h



### finiture / finishes

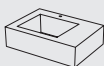

#### LAVABO IN CERAMICA / CERAMIC WASHBASIN

##### Le Terre di Cielo



NALAMXS

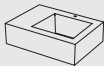

##### Le Acque di Cielo



NALAMDX



#### STRUTTURA IN ACCIAIO / STEEL FRAMEWORK

##### verniciature / coatings



NASTM



#### CASSETTIERA IN LEGNO / WOODEN DRAWERS

##### laccature / lacquers

##### Le Terre di Cielo



NACML / NACME

##### essenze / wooden finishes

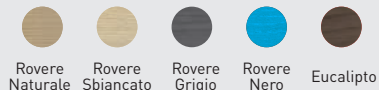

#### PORTASCIUGAMANI IN ACCIAIO / STEEL TOWEL RAIL

##### verniciature / coatings



NAPL



#### SACCA PORTABIANCHERIA IN CUOIO / LEATHER LAUNDRY BAG

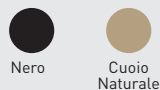

NASC

### note tecniche lavabo / washbasin technical notes



monofoforo predisposto 3 fori  
with 1 hole prepared 3 holes



senza foro su richiesta  
no tap hole on request



senza troppopieno  
without overflow



con un lato non smaltato  
one side is unglazed



installazione da piano  
on top installation



installazione sospesa  
wall-hung installation

# Modulo Ordine Narciso Mini

Narciso Mini Order Form

# cielo

CLIENTE/client:  ORD. REF.:

QUANTITA'/quantity:  EMAIL:

art. **NAPL** YES  NO

**FINITURA METALLICA**  
METAL FINISHES

- NM - Nero Matt
- BZ - Bronzo Spazzolato
- CM - Cemento

art. **NALAMXS** art. **NALAMD**

**FINITURE LAVABO**  
WASHBASIN SHELF FINISHES

Bianco/white - glossy

Le Terre di Cielo

<input type="radio"/> TL - Talco	<input type="radio"/> AN - Arenaria
<input type="radio"/> PM - Pomice	<input type="radio"/> AV - Avena
<input type="radio"/> BR - Brina	<input type="radio"/> LN - Lino
<input type="radio"/> BA - Basalto	<input type="radio"/> AG - Agave
<input type="radio"/> LV - Lavagna	<input type="radio"/> MU - Muschio
<input type="radio"/> CM - Cemento	<input type="radio"/> PL - Polvere
<input type="radio"/> FN - Fango	<input type="radio"/> CP - Cipria
<input type="radio"/> CA - Cacao	<input type="radio"/> CN - Canapa

Le Acque di Cielo

<input type="radio"/> OL - Oltremare	<input type="radio"/> CO - Corallo
<input type="radio"/> SM - Smeraldo	<input type="radio"/> NI - Ninfea
<input type="radio"/> AL - Alga	<input type="radio"/> AM - Anemone

art. **NABOX**

**FINITURE BOX PORTAOGGETTI**  
BOX PORTAOGGETTI FINISHES

verniciature\_coatings

- NM - Nero Matt
- BZ - Bronzo Spazzolato
- CM - Cemento

art. **NACL** / art. **NACE** (cassettiera - drawer unit)  
art. **NACML** / art. **NACME** (cassetto - drawer)

**FINITURE CASSETTO e CASSETTIERA**  
WOODEN DRAWER AND DRAWER UNIT FINISHES

laccature/laquerings [art. NACL - NACML]

<input type="radio"/> TL - Talco	<input type="radio"/> AV - Avena
<input type="radio"/> PM - Pomice	<input type="radio"/> CM - Cemento
<input type="radio"/> BR - Brina	<input type="radio"/> BA - Basalto
<input type="radio"/> AN - Arenaria	<input type="radio"/> MU - Muschio

essenze legno/wood essences [art. NACE - NACME]

<input type="radio"/> RG - Rovere Grigio	<input type="radio"/> RO - Rovere Nero
<input type="radio"/> RS - Rovere Sbiancato	<input type="radio"/> EU - Eucalipto
<input type="radio"/> RN - Rovere Naturale	

art. **NASC** YES  NO

**SACCA IN CUOIO**  
LEATHER LAUNDRY BAG

- NA - Cuio Naturale
- NE - Nero

art. **NASTM**

**FINITURE STRUTTURA**  
FRAMEWORK FINISHES

verniciature\_coatings

- NM - Nero Matt
- BZ - Bronzo Spazzolato
- CM - Cemento

**N.B. Il lavabo ha 1 foro predisposto 3 fori, su richiesta può essere prodotto senza foro**

*N.B. The washbasin has 1 hole prepared 3 holes ; may be made without holes upon request*

DATA  
DATE

FIRMA DEL CLIENTE  
SIGNATURE

ATTENZIONE:  
La rappresentazione delle finiture è puramente indicativa. Verificare le finiture con le relative cartelle.

Ogni oggetto possiede la peculiarità di essere elaborato secondo principi puramente tradizionali, in modo da garantirne l'assoluta originalità ed unicità. Le eventuali piccole variazioni di colore, tono o venature fra gli articoli sono da considerarsi pregi e non difetti, in quanto garanzia della fattura manuale del prodotto, che fa di ogni oggetto Cielo un pezzo unico ed esclusivo, lontano dall'omologazione industriale. In fase d'ordine si intendono, pertanto, accettate tali tolleranze che non possono dare adito a contestazioni di alcun genere.

Verificare sempre le disponibilità e i tempi di consegna con il commerciale.

ATTENTION:  
The representation of the finishes is merely indicative. Please choose the finishes using the folders.

Every item possesses that particular feature of being processed according to purely traditional principles that guarantee its absolute originality and uniqueness. The small variations in colour, hues or streaks on the items are to be considered as qualities and not defects, since they warranty the handcrafted processing which makes each Cielo item a unique and exclusive piece that cannot be compared to industrial standardization. When making the order, the client implicitly accepts those various features that may give rise to claims of any sort.

Always check the availability and delivery time with the commercial department.

## Configure the product directly online and send the order to Cielo.

Configure el producto directamente online y envíe el pedido a Cielo.  
 Configurez le produit directement en ligne et envoyez la commande à Cielo.  
 Konfigurieren Sie Ihr Produkt online und schicken Sie die Bestellung direkt an Cielo.  
 Сконфигурируйте изделие в онлайн и перешлите заказ на фабрику Cielo.

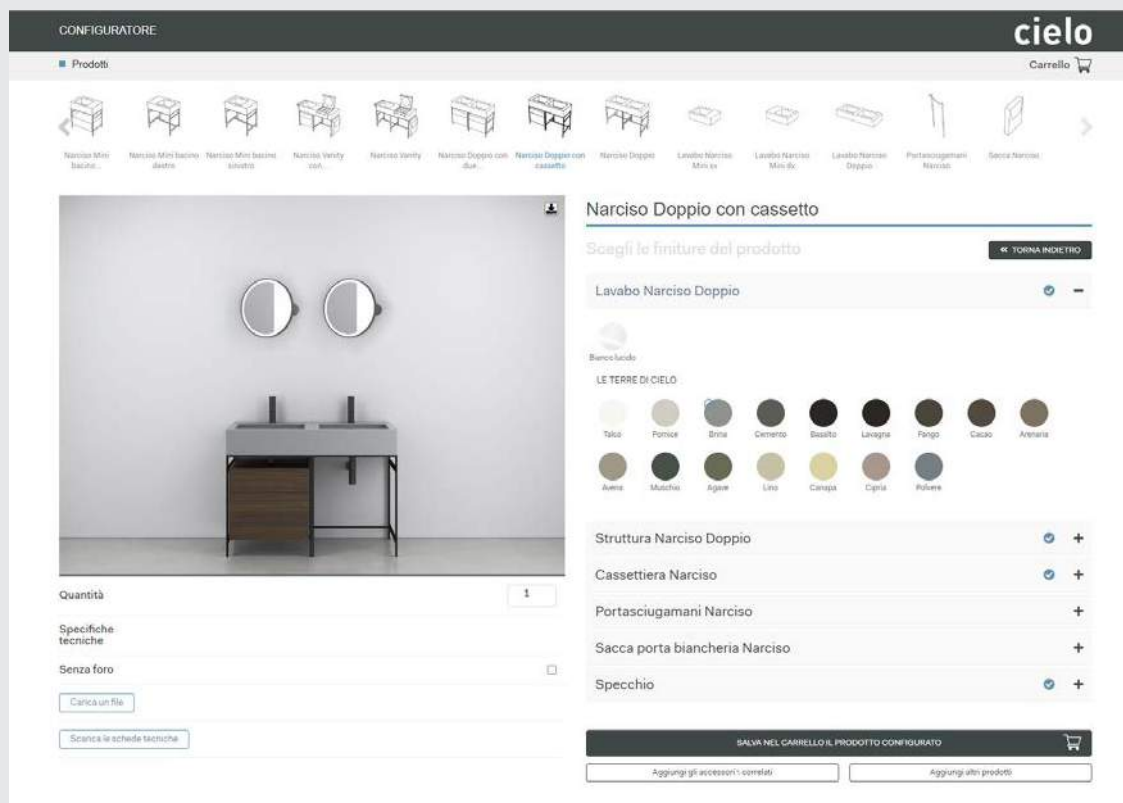

EN



go to the  
configurator

SP



ir al  
configurador

FR

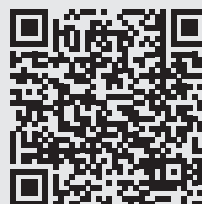

lien vers le  
configurateur

RU

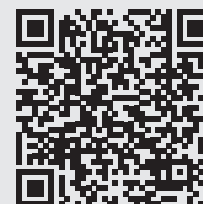

Перейдите в  
конфигуратор

## Narciso Doppio

113 x 50

### ceramic washbasin, wall-hung installation

lavabo de cerámica, instalación suspendida / lavabo en céramique installation suspendu / Waschbecken aus Keramik, hängender Installation / Керамическая раковина, приставленная установка

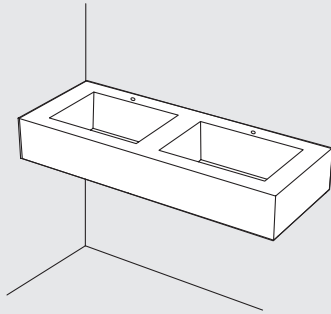

### ceramic washbasin, on top installation

lavabo de cerámica, instalación de apoyo / lavabo en céramique installation à poser / Waschbecken aus Keramik, Aufputz Installation / Керамическая раковина, поддерживаемая установка

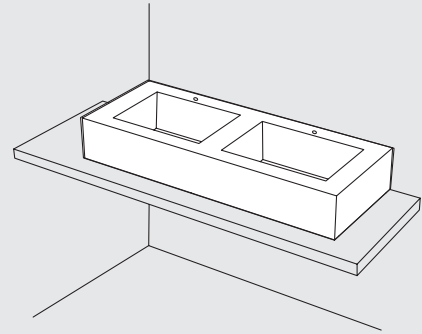

### ceramic washbasin with framework, two drawers, laundry bag and towel rails (right - left)

lavabo de cerámica con estructura, 2 cajones, bolsa y barra para toallasa / lavabo en céramique avec structure, 2 commode, sac à linge en cuir véritable et porte-serviettes / Waschbecken aus Keramik mit Stahlgestell, Handtuchhalter, 2 Holzschubfach, Wäschetasche aus Leder / Керамическая раковина с Стальной каркас, полотенцесушителей, два коробки с отделкой натуральным шпоном, Мешок для белья из кожи

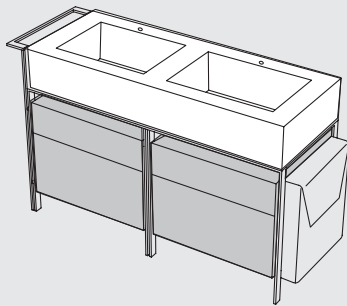

### ceramic washbasin with framework and towel rails (right - left)

lavabo de cerámica con estructura y barra para toallasa / lavabo en céramique avec structure et porte-serviettes / Waschbecken aus Keramik mit Stahlgestell, Handtuchhalter / Керамическая раковина с Стальной каркас, полотенцесушителей

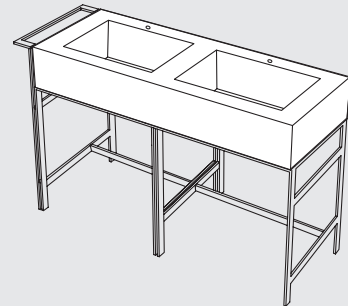

### ceramic washbasin with framework, left drawer unit, laundry bag and towel rails (right - left)

lavabo de cerámica con estructura, cajonera izquierda, bolsa y barra para toallasa / lavabo en céramique avec structure, commode gauche, sac à linge en cuir véritable, porte-serviettes / Waschbecken aus Keramik mit Stahlgestell, Handtuchhalter, Holzschubfach links, Wäschetasche aus Leder / Керамическая раковина с Стальной каркас, полотенцесушителей, левый комод, Мешок для белья из кожи

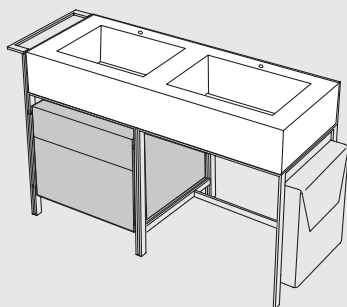

### ceramic washbasin with framework, right drawer unit, laundry bag and towel rails (right - left)

lavabo de cerámica con estructura, cajonera derecha, bolsa y barra para toallasa / lavabo en céramique avec structure, commode droit, sac à linge en cuir véritable, porte-serviettes / Waschbecken aus Keramik mit Stahlgestell, Handtuchhalter, Holzschubfach rechts, Wäschetasche aus Leder / Керамическая раковина с Стальной каркас, полотенцесушителей, право комод, Мешок для белья из кожи

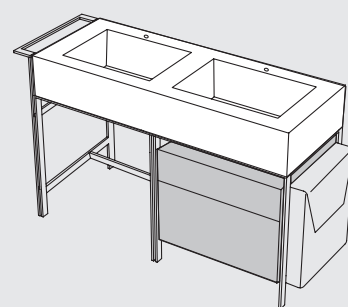

modelli disponibili / available models

## NARCISO DOPPIO

collection

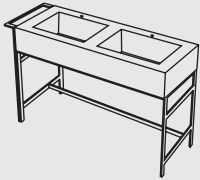

**Narciso Doppio senza cassettiere**  
Narciso Doppio without drawer units  
113 x 50 x 83 h

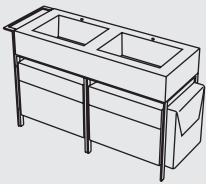

**Narciso Doppio con cassettiere**  
Narciso Doppio with drawer units  
113 x 50 x 83 h



finiture / finishes

### LAVABO IN CERAMICA / CERAMIC WASHBASIN

Le Terre di Cielo

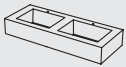

NALAD

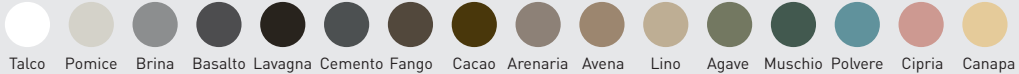

### STRUTTURA IN ACCIAIO / STEEL FRAMEWORK

verniciature / coatings



NASTD



### CASSETTIERA IN LEGNO / WOODEN DRAWERS

laccature / lacquers

Le Terre di Cielo

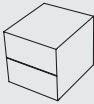

NACL \ NACE



essenze / wooden finishes

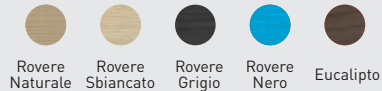

NAPL

### PORTASCIUGAMANI IN ACCIAIO / STEEL TOWEL RAIL

verniciature / coatings



NASC

### SACCA PORTABIANCHERIA IN CUOIO / LEATHER LAUNDRY BAG



note tecniche lavabo / washbasin technical notes

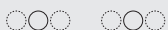

2 fori predisposto 6 fori  
with 2 holes prepared 6 holes



senza foro su richiesta  
no tap hole on request



senza troppopieno  
without overflow



con un lato non smaltato  
one side is unglazed



installazione da piano  
on top installation



installazione sospesa  
wall-hung installation

# Modulo Ordine Narciso Doppio

Narciso Doppio Order Form

# cielo

handmade in Italy

CLIENTE/client:  ORD. REF.:

QUANTITA'/quantity:  EMAIL:

art. **NAPL** YES  NO

- FINITURA METALLICA**  
METAL FINISHES
- NM - Nero Matt
  - BZ - Bronzo Spazzolato
  - CM - Cemento

art. **NALAD \ NALADSF**

**FINITURE LAVABO**

WASHBASIN SHELF FINISHES

- Bianco
- Le Terre di Cielo
- TL - Talco
- PM - Pomice
- BR - Brina
- BA - Basalto
- LV - Lavagna
- CM - Cemento
- FN - Fango
- CA - Cacao
- AN - Arenaria
- AV - Avena
- LN - Lino
- AG - Agave
- MU - Muschio
- PL - Polvere
- CP - Cipria
- CN - Canapa

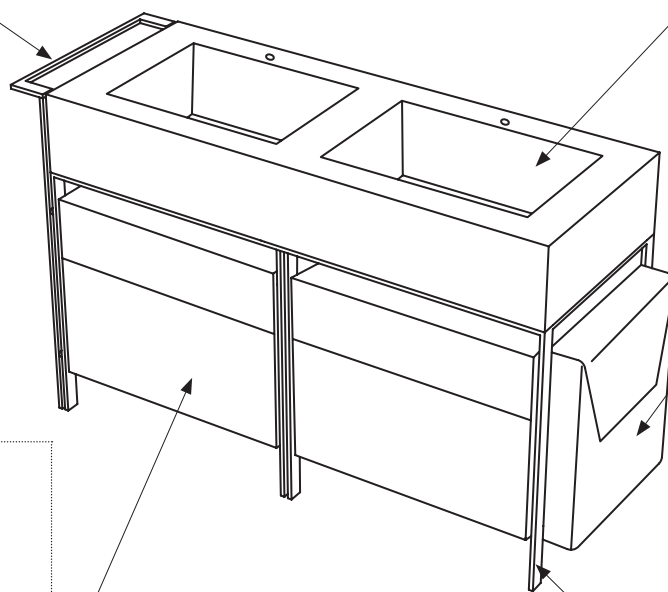

art. **NACL / art. NACE**

**FINITURE CASSETTIERA**

WOODEN DRAWER FINISHES

laccature/laquerings (art. NACL)

- TL - Talco
- PM - Pomice
- BR - Brina
- AN - Arenaria
- AV - Avena
- CM - Cemento
- BA - Basalto
- MU - Muschio

essenze legno/wood essences (art. NACE)

- RG - Rovere Grigio
- RS - Rovere Sbiancato
- RN - Rovere Naturale
- RO - Rovere Nero
- EU - Eucalipto

art. **NASC** YES  NO

**SACCA IN CUOIO**

LEATHER LAUNDRY BAG

- NA - Cuio Naturale
- NE - Nero

art. **NASTD**

**FINITURE STRUTTURA**

FRAMEWORK FINISHES

verniciature\_coatings

- NM - Nero Matt
- BZ - Bronzo Spazzolato
- CM - Cemento

**N.B. Il lavabo ha 2 fori predisposto 6 fori, su richiesta può essere prodotto senza foro**

*N.B. The washbasin has 2 holes prepared 6 holes ; may be made without holes upon request*

**DATA**

DATE

**FIRMA DEL CLIENTE**

SIGNATURE

**ATTENZIONE:**

La rappresentazione delle finiture è puramente indicativa. Verificare le finiture con le relative cartelle.

Ogni oggetto possiede la peculiarità di essere elaborato secondo principi puramente tradizionali, in modo da garantirne l'assoluta originalità ed unicità. Le eventuali piccole variazioni di colore, tono o venature fra gli articoli sono da considerarsi pregi e non difetti, in quanto garanzia della fattura manuale del prodotto, che fa di ogni oggetto Cielo un pezzo unico ed esclusivo, lontano dall'omologazione industriale. In fase d'ordine si intendono, pertanto, accettate tali tolleranze che non possono dare adito a contestazioni di alcun genere.

Verificare sempre le disponibilità e i tempi di consegna con il commerciale.











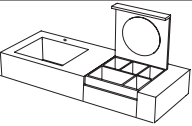
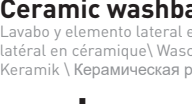

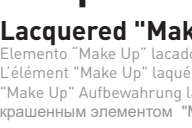





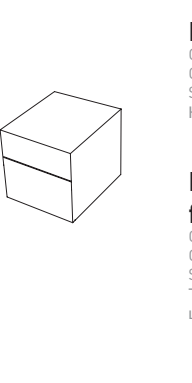

**ATTENTION:**

The representation of the finishes is merely indicative. Please choose the finishes using the folders.

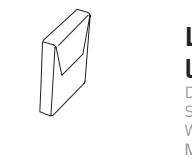
Every item possesses that particular feature of being processed according to purely traditional principles that guarantee its absolute originality and uniqueness. The small variations in colour, hues or streaks on the items are to be considered as qualities and not defects, since they warranty the handcrafted processing which makes each Cielo item a unique and exclusive piece that cannot be compared to industrial standardization. When making the order, the client implicitly accepts those various features that may give rise to claims of any sort.

Always check the availability and delivery time with the commercial department.























	<b>Size (cm)</b> Medidas Dimensions Maße Размеры	<b>Product code</b> Artículo Article Artikel Артикул	<b>Net weight (Kg)</b> Peso neto Poids net Reingewicht вес нетто	<b>Finishes</b> Acabados Finitions Farbe Отделка	<b>Euro</b> Евро	<b>Pz.</b> шт. pallet Italia	<b>Pz.</b> шт. pallet Cont.
 <p><b>Ceramic washbasin and side element</b>                      Lavabo y elemento lateral en cerámica \ Lavabo et élément latéral en céramique \ Waschbecken und Seitenelement aus Keramik \ Керамическая раковина и боковой элемент</p>	130 x 50						
 <p><b>Lacquered "Make Up" element</b>                      Elemento "Make Up" lacado                      L'élément "Make Up" laqué                      "Make Up" Aufbewahrung lackierte                      крашенным элементом "Make Up"</p>	76 x 50 x 16,5 h	NALA(X)*  NALASF(X)* no tap hole sin agujero sans orifice ohne Loch без отверстия	33,50	 <b>Le Terre di Cielo</b>	1592,00		
 <p><b>"Make Up" element in wooden finish</b>                      "Make Up" en madera                      élément "Make Up" en bois                      "Make Up" Aufbewahrung aus Holz                      "Make Up" с отделкой натуральным шпоном</p>	41,5 x 50 x 16,5 h	NAMUL(X)*	10,50	 <b>Le Terre di Cielo*</b>	2217,00		
 <p><b>Steel framework</b>                      Estructura de acero                      Structure en acier                      Stahlgestell                      Стальной каркас</p>	41,5 x 50 x 16,5 h	NAMUE(X)*	10,50	<b>EsSENze</b>  <ul style="list-style-type: none"> <li>*X = RN - Rovere Naturale</li> <li>*X = RS - Rovere Sbiancato</li> <li>*X = RO - Rovere Nero</li> <li>*X = RG - Rovere Grigio</li> </ul>	2565,00		
 <p><b>Lacquered drawer unit</b>                      Cajonera lacada                      Commode laqué                      Schubladenelement lackiert                      Крашенная тумба</p>	130 x 50 x 66,5 h	NAST(X)*	12,00	 *X = NM <b>Matt Black</b>  *X = BZ <b>Brushed Bronze</b>  *X = CM <b>Cemento</b>	1726,00 2334,00 1726,00		
 <p><b>Drawer unit in wooden finish</b>                      Cajonera en madera                      Commode en bois                      Schubladenelement                      Тумба с отделкой натуральным шпоном</p>	52 x 50 x 46,5 h	NACL(X)*	29,50	 <b>Le Terre di Cielo*</b>	1263,00		
 <p><b>Towel rail</b>                      Barra para toallasa                      Porte-serviettes                      Handtuchhalter                      полотенцесушителей</p>	52 x 50 x 46,5 h	NACE(X)*	29,50	<b>EsSENze</b>  <ul style="list-style-type: none"> <li>*X = RN - Rovere Naturale</li> <li>*X = RS - Rovere Sbiancato</li> <li>*X = RO - Rovere Nero</li> <li>*X = RG - Rovere Grigio</li> </ul>  *X = EU - Eucalipto	1430,00 1646,00		
 <p><b>Laundry bag in real leather</b>                      De cuero bolsa de lino                      Sac a linge en cuir véritable                      Wäschetasche aus Leder                      Мешок для белья из кожи</p>	10 x 50 x 83 h	NAPL(X)*	2,00	 *X = NM <b>Matt Black</b>  *X = BZ <b>Brushed Bronze</b>  *X = CM <b>Cemento</b>	229,00 332,00 229,00		
<p><b>Laundry bag in real leather</b>                      De cuero bolsa de lino                      Sac a linge en cuir véritable                      Wäschetasche aus Leder                      Мешок для белья из кожи</p>	45 x 14 x 50 h	NASC(X)*	3,20	 *X = NA <b>Leather</b>  *X = NE <b>Black</b>	1300,00 1300,00		

# Narciso Vanity

drains and siphons / desagües y sifones / les drains et les siphons / Ablaufgarnituren und Siphons / Донные клапаны и сифоны

# cielo

	Product code Artículo Article Artikel Артикул	Net weight <sub>(kg)</sub> Peso neto Poids net Reingewicht вес нетто	Finishes Acabados Finitions Farbe Отделки	Euro Евро
 <p><b>Universal click/clack drain in CHROME with ceramic lid</b> Válvula universal click/clack Cromado con tapa en cerámica Bonde universelle clic/clac Chromé avec clapet en céramique Universal-Ablaufgarnitur Click-Clack Chrom mit Keramikstopfen Универсальный донный клапан click/clack хром с керамической крышкой</p>	PIL01(X)*	0,40	 <b>Gloss White</b>	<b>95,00</b>
			 <b>Le Terre di Cielo</b>	<b>139,00</b>
 <p><b>Universal click/clack drain in BLACK MATT finish with ceramic lid</b> Válvula universal click/clack Negro Matt con tapa en cerámica Bonde universelle clic/clac Noir Mat avec clapet en céramique Universal-Ablaufgarnitur Click-Clack Matt Schwarz mit Keramikstopfen Универсальный донный клапан click/clack черный матовый с керамической крышкой</p>	PIL01NM(X)*	0,40	 <b>Gloss White</b>	<b>120,00</b>
			 <b>Le Terre di Cielo</b>	<b>169,00</b>
 <p><b>Universal click/clack drain in CEMENTO finish with ceramic lid</b> Válvula universal click/clack Cemento con tapa en cerámica Bonde universelle clic/clac Cemento avec clapet en céramique Universal-Ablaufgarnitur Click-Clack Cement mit Keramikstopfen Универсальный донный Cemento click/clack с керамической крышкой</p>	PIL01CM(X)*	0,40	 <b>Gloss White</b>	<b>120,00</b>
			 <b>Le Terre di Cielo</b>	<b>169,00</b>
 <p><b>Universal click/clack drain in BRONZE with ceramic lid</b> Válvula universal click/clack Bronce con tapa en cerámica Bonde universelle clic/clac Bronce avec clapet en céramique Universal-Ablaufgarnitur Click-Clack Bronze mit Keramikstopfen Универсальный донный клапан click/clack бронза с керамической крышкой</p>	PIL01BR(X)*	0,40	 <b>Gloss White</b>	<b>135,00</b>
			 <b>Le Terre di Cielo</b>	<b>182,00</b>
 <p><b>CHROMED siphon</b> Sifone Cromado \ Siphon Chromé \ Siphon Verchromt \ сифон Chrome</p>	SISP	0,93	 <b>Chrome</b>	<b>133,00</b>
 <p><b>MATT BLACK siphon</b> Sifone Negro Mate \ Siphon Noir Mat \ Siphon Schwarz Matt \ Сифон Черный матовый</p>	SIFN	0,93	 <b>Matt Black</b>	<b>194,00</b>
 <p><b>CEMENTO siphon</b> Sifone Cemento \ Siphon Cemento \ Siphon Cemento \ сифон Cemento</p>	SIFCM	0,93	 <b>Cemento</b>	<b>194,00</b>
 <p><b>BRONZE siphon</b> Sifone Bronce \ Siphon Bronze \ Siphon Bronze \ бронза сифон</p>	SIFBR	0,93	 <b>Bronze</b>	<b>220,00</b>

With the installation of the drawer, we recommend matching it with our SISP - SIFN - SIFCM - SIFBR siphons/traps / Con la instalación del cajón aconsejamos de combinar nuestros sifones SISP-SIFN-SIFCM-SIFBR / Terre di Cielo disponibles pour les lavabos et le plan en céramique / Bei Montage der Schublade empfehlen wir unsere Siphons SISP - SIFN - SIFCM - SIFBR / При установке ящика рекомендуем сочетать наши сифоны SISP - SIFN - SIFCM - SIFBR

Terre di Cielo available for ceramic washbasin / Terre di Cielo disponibles para lavabo de cerámica / Terre di Cielo disponibles pour les lavabos en céramique / Für Waschbecken erhältliche Terre di Cielo / Отделка Terre di Cielo доступны для раковин и керамических столешниц

 TL - Talco	 PM - Pomice	 BR - Brina	 BA - Basalto	 LN - Lino	 FN - Fango
 CA - Cacao	 AN - Arenaria	 AV - Avena	 CM - Cemento	 MU - Muschio	 AG - Agave
 PL - Polvere	 CP - Cipria	 CN - Canapa	 LV - Lavagna		

\* Terre di Cielo laquering available for "Make up" and drawer unit / lacado Terre di Cielo disponible para elemento "Make Up" y cajonera / laquages Terre di Cielo disponibles pour l'élément « Make Up » et meuble tiroir / Für Make Up-Element und Schubladenelement erhältliche Lackierungen Terre di Cielo / крашенная отделка Terre di Cielo доступна для ящика и элемент "Make Up"

 TL - Talco	 PM - Pomice	 BR - Brina	 AN - Arenaria
 BA - Basalto	 MU - Muschio	 AV - Avena	 CM - Cemento

## ! Mandatory combination: washbasin + "Make Up" element + framework











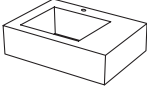



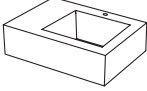







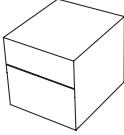

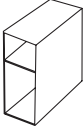

combinaison obligatoire: lavabo + élément "Make Up" + structure  
Combinación obligatoria: lavabo + elemento "Make Up" + estructura  
obligatorische Kombination: Waschbecken + "Make Up" + Stahlgestell  
обязательное сочетание: умывальник + элементом "Make Up" + Стальной каркас

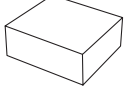























Technical symbols legend / Símbolos técnicos clave / Légende symboles techniques / Technische Zeichenerklärung / Перечень технических символов

 with 1 hole prepared 3 holes  
avec un trou prédisposition à trois trous  
mit 1-Loch auf 3-Loch durchschlagbar  
одно отверстие с возможностью выполнения трех отверстий

 no tap hole on requeste  
sin agujero, solo a petición  
sans orifice sur demande  
auf Anfrage ohne Loch  
без отверстия под смеситель по запросу

 without overflow  
sin rebosadero  
sans trop-plein  
ohne Überlauf  
без слива-перелива

	Size (cm) Medidas Dimensions Maße Размеры	Product code Artículo Article Artikel Артикул	Net weight (Kg) Peso neto Poids net Reingewicht вес нетто	Finishes Acabados Finitions Farbe Отделка	Euro Евро
 <p><b>Ceramic left washbasin with 1 hole /</b> Lavabo de cerámica con un agujero, seno izquierda / Lavabo en céramique avec un trou, vasque à gauche / Waschbecken aus Keramik mit 1 Hahnloch, Becken links / Керамическая раковина с 1-им отверстием, чаша слева</p>	76 x 50 x 16,5 h	NALAMSX(X)*  NALAMXSXF(X)* no tap hole sin agujero - sans orifice - ohne Loch без отверстия	28,50	 <b>Gloss White</b>	<b>847,00</b>
				 <b>Le Terre di Cielo</b>	<b>1187,00</b>
				 <b>Le Acque di Cielo</b>	<b>1187,00</b>
 <p><b>Ceramic right washbasin with 1 hole /</b> lavabo de cerámica con un agujero, seno derecha / Lavabo en céramique avec un trou, vasque à droite / Waschbecken aus Keramik mit 1 Hahnloch, Becken rechts / Керамическая раковина с 1-им отверстием, чаша справа</p>	76 x 50 x 16,5 h	NALAMDX(X)*  NALAMDXSF(X)* no tap hole sin agujero - sans orifice - ohne Loch без отверстия	28,50	 <b>Gloss White</b>	<b>847,00</b>
				 <b>Le Terre di Cielo</b>	<b>1187,00</b>
				 <b>Le Acque di Cielo</b>	<b>1187,00</b>
 <p><b>Steel framework</b> Estructura de acero / Structure en acier / Stahlgestell / Стальной каркас</p>	76 x 50 x 66 h	NASTM(X)*	6,50	 *X = <b>NM - Matt Black</b>	<b>1027,00</b>
				 *X = <b>BZ - Brushed Bronze</b>	<b>1487,00</b>
				 *X = <b>CM - Cemento</b>	<b>1027,00</b>
 <p><b>Lacquered drawer unit</b> Cajonera lacada / Commode laqué / Schubladenelement lackiert / Крашенная тумба</p>	52 x 50 x 46,5 h	NACL(X)*	29,50	 <b>Le Terre di Cielo *</b>	<b>1263,00</b>
				<p><b>Drawer unit in wooden finish</b> Cajonera en madera / Commode en bois / Schubladenelement / Тумба с отделкой натуральным шпоном</p>	52 x 50 x 46,5 h
 <p><b>Metal storage box</b> Box porta objetos metálico / Compartiment de rangement en métal / Ablagebox / Металлическая база с открытыми отделениями</p>	19 x 50 x 46,5 h	NABOX(X)*	10,40	 *X = <b>NM - Matt Black</b>	
				 *X = <b>BZ - Brushed Bronze</b>	<b>462,00</b>
				 *X = <b>CM - Cemento</b>	<b>462,00</b>
 <p><b>Lacquered drawer</b> Cajón lacado / Tiroir laqué / Schubfach lackiert / Крашенный ящик</p>	72 x 50 x 20 h	NACML(X)*	23,00	 <b>Le Terre di Cielo *</b>	<b>1155,00</b>
				<p><b>Drawer in wooden finish</b> Cajón de madera / Tiroir en bois / Holzschubfach / Ящик с отделкой натуральным шпоном</p>	72 x 50 x 20 h
 <p><b>Towel rail</b> Barra para toallasa / Porte-serviettes / Handtuchhalter / полотенцесушителей</p>	10 x 50 x 83 h	NAPL(X)*	2,00	 *X = <b>NM - Matt Black</b>	
				 *X = <b>BZ - Brushed Bronze</b>	<b>332,00</b>
				 *X = <b>CM - Cemento</b>	<b>229,00</b>
 <p><b>Laundry bag in real leather</b> De cuero bolsa de lino / ac a linge en cuir véritable / Wäschetasche aus Leder / Мешок для белья из кожи</p>	45 x 14 x 50 h	NASCL(X)*	3,20	 *X = <b>NA - Leather</b>	<b>1300,00</b>
				 *X = <b>NE - Black</b>	<b>1300,00</b>

	Product code Artículo Article Artikel Артикул	Net weight <sub>(Kg)</sub> Peso neto Poids net Reingewicht вес нетто	Finishes Acabados Finitions Farbe Отделка	Euro Евро
	<b>Universal click/clack drain in CHROME with ceramic lid</b> Válvula universal click/clack Cromado con tapa en cerámica Bonde universelle clic/clac Chromé avec clapet en céramique Universal-Abflussgarnitur Click-Clack Chrom mit Keramikstopfen Универсальный дренажный клапан click/clack хром с керамической крышкой	PIL01(X)* 0,40	 <b>Gloss White</b>  <b>Le Terre di Cielo</b>  <b>Le Acque di Cielo</b>	<b>95,00</b> <b>139,00</b> <b>139,00</b>
	<b>Universal click/clack drain in BLACK MATT finish with ceramic lid</b> Válvula universal click/clack Negro Matt con tapa en cerámica Bonde universelle clic/clac Noir Mat avec clapet en céramique Universal-Abflussgarnitur Click-Clack Matt Schwarz mit Keramikstopfen Универсальный дренажный клапан click/clack черный матовый с керамической крышкой	PIL01NM(X)* 0,40	 <b>Gloss White</b>  <b>Le Terre di Cielo</b>  <b>Le Acque di Cielo</b>	<b>120,00</b> <b>169,00</b> <b>169,00</b>
	<b>Universal click/clack drain in CEMENTO finish with ceramic lid</b> Válvula universal click/clack Cemento con tapa en cerámica Bonde universelle clic/clac Cemento avec clapet en céramique Universal-Abflussgarnitur Click-Clack Cement mit Keramikstopfen Универсальный дренажный клапан Cemento click/clack с керамической крышкой	PIL01CM(X)* 0,40	 <b>Gloss White</b>  <b>Le Terre di Cielo</b>  <b>Le Acque di Cielo</b>	<b>120,00</b> <b>169,00</b> <b>169,00</b>
	<b>Universal click/clack drain in BRONZE with ceramic lid</b> Válvula universal click/clack Bronce con tapa en cerámica Bonde universelle clic/clac Bronze avec clapet en céramique Universal-Abflussgarnitur Click-Clack Bronze mit Keramikstopfen Универсальный дренажный клапан click/clack бронза с керамической крышкой	PIL01BR(X)* 0,40	 <b>Gloss White</b>  <b>Le Terre di Cielo</b>  <b>Le Acque di Cielo</b>	<b>135,00</b> <b>182,00</b> <b>182,00</b>
	<b>CHROMED siphon</b> Sifone Cromado \ Siphon Chromé \ Siphon Verchromt \ сифон Chrome	SISP 0,93	 <b>Chrome</b>	<b>133,00</b>
	<b>MATT BLACK siphon</b> Sifone Negro Mate \ Siphon Noir Mat \ Siphon Schwarz Matt \ Сифон Черный матовый	SIFN 0,93	 <b>Matt Black</b>	<b>194,00</b>
	<b>CEMENTO siphon</b> Sifone Cemento \ Siphon Cemento \ Siphon Cemento \ сифон Cemento	SIFCM 0,93	 <b>Cemento</b>	<b>194,00</b>
	<b>BRONZE siphon</b> Sifone Bronce \ Siphon Bronce \ Siphon Bronze \ бронза сифон	SIFBR 0,93	 <b>Bronze</b>	<b>220,00</b>

With the installation of the drawer unit and drawer, we recommend matching it with our SISP - SIFN - SIFCM - SIFBR siphons/traps / Con la instalación del cajón y de cajonera aconsejamos de combinar nuestros sifones SISP-SIFN-SIFCM-SIFBR / Bei Montage der Schublade empfehlen wir unsere Siphons SISP - SIFN - SIFCM - SIFBR / При установке ящика рекомендуем сочетать наши сифоны SISP - SIFN - SIFCM - SIFBR

Terre di Cielo available for ceramic washbasin / Terre di Cielo disponibles para lavabo de cerámica / Terre di Cielo disponibles pour les lavabos en céramique / Für Waschbecken erhältliche Terre di Cielo / Отделка Terre di Cielo доступны для раковин и керамических столешниц

-  TL - Talco
-  PM - Pomice
-  BR - Brina
-  BA - Basalto
-  LN - Lino
-  FN - Fango
-  CA - Cacao
-  AN - Arenaria
-  AV - Avena
-  CM - Cemento
-  MU - Muschio
-  AG - Agave
-  PL - Polvere
-  CP - Cipria
-  CN - Canapa
-  LV - Lavagna

\* Terre di Cielo laquering available for drawer and drawer unit / Lacado Terre di Cielo disponible para cajonera y cajón / laquages Terre di Cielo disponibles pour le tiroir et commode / Für die Schublade erhältliche Lackierungen Terre di Cielo / крашеная отделка Terre di Cielo доступна для ящика

-  TL - Talco
-  PM - Pomice
-  BR - Brina
-  AN - Arenaria
-  BA - Basalto
-  MU - Muschio
-  AV - Avena
-  CM - Cemento

Acque di Cielo available for ceramic washbasin / Acque di Cielo disponibles para lavabo de cerámica / Acque di Cielo disponibles pour les lavabos en céramique / Für Waschbecken erhältliche Acque di Cielo / Отделка Acque di Cielo доступны для раковин и керамических столешниц

-  OL - Oltremare
-  SM - Smeraldo
-  AL - Alga
-  CO - Corallo
-  NI - Ninfea
-  AM - Anemone

Technical symbols legend / Símbolos técnicos clave / Légende symboles techniques / Technische Zeichenerklärung / Перечень технических символов

 **with 1 hole prepared 3 holes**  
1 agujero predispuesto 3 agujeros  
avec un trou prédisposition à trois trous  
mit 1-Loch auf 3-Loch durchschlagbar  
одно отверстие с возможностью  
выполнения трех отверстий

 **no tap hole on request**  
sin agujero, solo a petición  
sans orifice sur demande  
auf Anfrage ohne Loch  
без отверстия под смеситель  
по запросу

 **without overflow**  
sin rebosadero  
sans trop-plein  
ohne Überlauf  
без слива-перелива

 **one side is unglazed**  
con un lado sin esmaltar  
avec un côté non émaillé  
eine Seite unglasiert  
одна сторона не покрыта  
эмалью

 **on top installation**  
instalación de apoyo  
installation à partir du plan  
Montage auf Platte  
установка на столешницу

 **wall-hung installation**  
instalación suspendida  
installation suspendue  
wandhängende Montage  
подвесная установка





















 **with fixing parts**  
fijaciones incluidas  
fixations incluses  
inklusive Befestigungen  
в комплекте с крепежами

	Size (cm)	Product code	Net weight (Kg)	Finishes	Euro
	Medidas Dimensions Maße Размеры	Artículo Article Artikel Артикул	Peso neto Poids net Reingewicht вес нетто	Acabados Finitions Farbe Отделки	Евро
	113 x 50				
	113 x 50 x 16,5 h	NALAD(X)* NALADSF(X)* no tap hole sin agujero - sans orifice - ohne Loch без отверстия	37,50	<b>Gloss White</b>	1316,00
				<b>Le Terre di Cielo</b>	1911,00
	113 x 50 x 66,5 h	NASTD(X)*	11,00	*X = <b>NM - Matt Black</b>	1510,00
				*X = <b>BZ - Brushed Bronze</b>	2153,00
				*X = <b>CM - Cemento</b>	1510,00
	52 x 50 x 46,5 h	NACL(X)*	29,50	<b>Le Terre di Cielo*</b>	1263,00
	52 x 50 x 46,5 h	NACE(X)*	29,50	<b>Essenze</b> *X = <b>RN - Rovere Naturale</b> *X = <b>RS - Rovere Sbiancato</b> *X = <b>RO - Rovere Nero</b> *X = <b>RG - Rovere Grigio</b>	1430,00
				*X = <b>EU - Eucalipto</b>	1646,00
	10 x 50 x 83 h	NAPL(X)*	2,00	*X = <b>NM - Matt Black</b>	229,00
				*X = <b>BZ - Brushed Bronze</b>	332,00
				*X = <b>CM - Cemento</b>	229,00
	45 x 14 x 50 h	NASC(X)*	3,20	*X = <b>NA - Leather</b>	1300,00
				*X = <b>NE - Black</b>	1300,00

# Narciso Doppio

# cielo

drains and siphons / desagües y sifones / les drains et les siphons / Ablaufgarnituren und Siphons / Донные клапаны и сифоны

	Product code Artículo Article Artikel Артикул	Net weight <sub>(Kg)</sub> Peso neto Poids net Reingewicht вес нетто	Finishes Acabados Finitions Farbe Отделка	Euro Евро
 <p><b>Universal click/clack drain in CHROME with ceramic lid</b> Válvula universal click/clack Cromado con tapa en cerámica Bonde universelle clic/clac Chromé avec clapet en céramique Universal-Ablaufgarnitur Click-Clack Chrom mit Keramikstopfen Универсальный донный клапан click/clack хром с керамической крышкой</p>	PIL01(X)*	0,40	 <b>Gloss White</b>	<b>95,00</b>
			 <b>Le Terre di Cielo</b>	<b>139,00</b>
 <p><b>Universal click/clack drain in BLACK MATT finish with ceramic lid</b> Válvula universal click/clack Negro Matt con tapa en cerámica Bonde universelle clic/clac Noir Mat avec clapet en céramique Universal-Ablaufgarnitur Click-Clack Matt Schwarz mit Keramikstopfen Универсальный донный клапан click/clack черный матовый с керамической крышкой</p>	PIL01NM(X)*	0,40	 <b>Gloss White</b>	<b>120,00</b>
			 <b>Le Terre di Cielo</b>	<b>169,00</b>
 <p><b>Universal click/clack drain in CEMENTO finish with ceramic lid</b> Válvula universal click/clack Cemento con tapa en cerámica Bonde universelle clic/clac Cemento avec clapet en céramique Universal-Ablaufgarnitur Click-Clack Cement mit Keramikstopfen Универсальный донный Cemento click/clack с керамической крышкой</p>	PIL01CM(X)*	0,40	 <b>Gloss White</b>	<b>120,00</b>
			 <b>Le Terre di Cielo</b>	<b>169,00</b>
 <p><b>Universal click/clack drain in BRONZE with ceramic lid</b> Válvula universal click/clack Bronce con tapa en cerámica Bonde universelle clic/clac Bronze avec clapet en céramique Universal-Ablaufgarnitur Click-Clack Bronze mit Keramikstopfen Универсальный донный клапан click/clack бронза с керамической крышкой</p>	PIL01BR(X)*	0,40	 <b>Gloss White</b>	<b>135,00</b>
			 <b>Le Terre di Cielo</b>	<b>182,00</b>
 <p><b>CHROMED siphon</b> Sifone Cromado \ Siphon Chromé \ Siphon Verchromt \ сифон Chrome</p>	SISP	0,93	 <b>Chrome</b>	<b>133,00</b>
 <p><b>MATT BLACK siphon</b> Sifone Negro Mate \ Siphon Noir Mat \ Siphon Schwarz Matt \ Сифон Черный матовый</p>	SIFN	0,93	 <b>Matt Black</b>	<b>194,00</b>
 <p><b>CEMENTO siphon</b> Sifone Cemento \ Siphon Cemento \ Siphon Cemento \ сифон Cemento</p>	SIFCM	0,93	 <b>Cemento</b>	<b>194,00</b>
 <p><b>BRONZE siphon</b> Sifone Bronce \ Siphon Bronze \ Siphon Bronze \ бронза сифон</p>	SIFBR	0,93	 <b>Bronze</b>	<b>220,00</b>

With the installation of the drawer unit and drawer, we recommend matching it with our SISP - SIFN - SIFCM - SIFBR siphons/traps / Con la instalación del cajón y de cajonera aconsejamos de combinar nuestros sifones SISP-SIFN-SIFCM-SIFBR | Bei Montage der Schublade empfehlen wir unsere Siphons SISP - SIFN - SIFCM - SIFBR / При установке ящика рекомендуем сочетать наши сифоны SISP - SIFN - SIFCM - SIFBR

Terre di Cielo available for ceramic washbasin / Terre di Cielo disponibles para lavabo de cerámica / Terre di Cielo disponibles pour les lavabos en céramique / Für die Schublade erhältliche Lackierungen Terre di Cielo / Отделка Terre di Cielo доступны для раковин и керамических столешниц

-  TL - Talco
-  PM - Pomice
-  BR - Brina
-  BA - Basalto
-  LN - Lino
-  FN - Fango
-  CA - Cacao
-  AN - Arenaria
-  AV - Avena
-  CM - Cemento
-  MU - Muschio
-  AG - Agave
-  PL - Polvere
-  CP - Cipria
-  CN - Canapa
-  LV - Lavagna

\* Terre di Cielo laquering available for drawer / lacados Terre di Cielo disponibles para cajones / laquages Terre di Cielo disponibles pour le tiroir / Für die Schublade erhältliche Lackierungen Terre di Cielo / крашенная отделка Terre di Cielo доступна для ящика

-  TL - Talco
-  PM - Pomice
-  BR - Brina
-  AN - Arenaria
-  BA - Basalto
-  MU - Muschio
-  AV - Avena
-  CM - Cemento

Technical symbols legend / Símbolos técnicos clave / Légende symboles techniques / Technische Zeichenerklärung / Перечень технических символов

 with 2 hole prepared 6 holes  
avec deux trou prédisposition à six trous  
mit 2-Loch auf 6-Loch durchschlagbar  
одно отверстие с возможностью выполнения трех отверстий

 no tap hole on request  
sin agujero, solo a petición  
sans orifice sur demande  
auf Anfrage ohne Loch  
без отверстия под смеситель по запросу

 without overflow  
sin rebosadero  
sans trop-plein  
ohne Überlauf  
без слива-перелива

 one side is unglazed  
con un lado sin esmaltar  
avec un côté non émaillé  
eine Seite unglasiert  
одна сторона не покрыта эмалью

 on top installation  
instalación de apoyo  
installation à partir du plan  
Montage auf Platte  
установка на столешницу

 wall-hung installation  
instalación suspendida  
installation suspendue  
wandhängende Montage  
подвесная установка

 with fixing parts  
fijaciones incluidas  
fixations incluses  
inklusive Befestigungen  
в комплекте с крепежами





# Arcadia

design Andrea Parisio, Giuseppe Pezzano

## TIBERINO

- QR code configuratore \ configurator pg. 324
- finiture \ finishes pg. 326
- indice collezione \ collection pg. 327
- modulo d'ordine \ order form pg. 333
- listino prezzi \ price list pg. 334 - 335

## VASCHE \ BATH TUBS

- finiture \ finishes pg. 326
- indice collezione \ collection pg. 327
- listino prezzi \ price list pg. 338 - 339

## SPECCHI \ MIRRORS

- finiture \ finishes pg. 330 - 331
- indice collezione \ collection pg. 329
- listino prezzi \ price list pg. 342 - 349

Configure the product directly online and send the order to Cielo.

Configure el producto directamente online y envíe el pedido a Cielo.

Configurez le produit directement en ligne et envoyez la commande à Cielo.

Konfigurieren Sie Ihr Produkt online und schicken Sie die Bestellung direkt an Cielo.

Сконфигурируйте изделие в онлайн и перешлите заказ на фабрику Cielo.

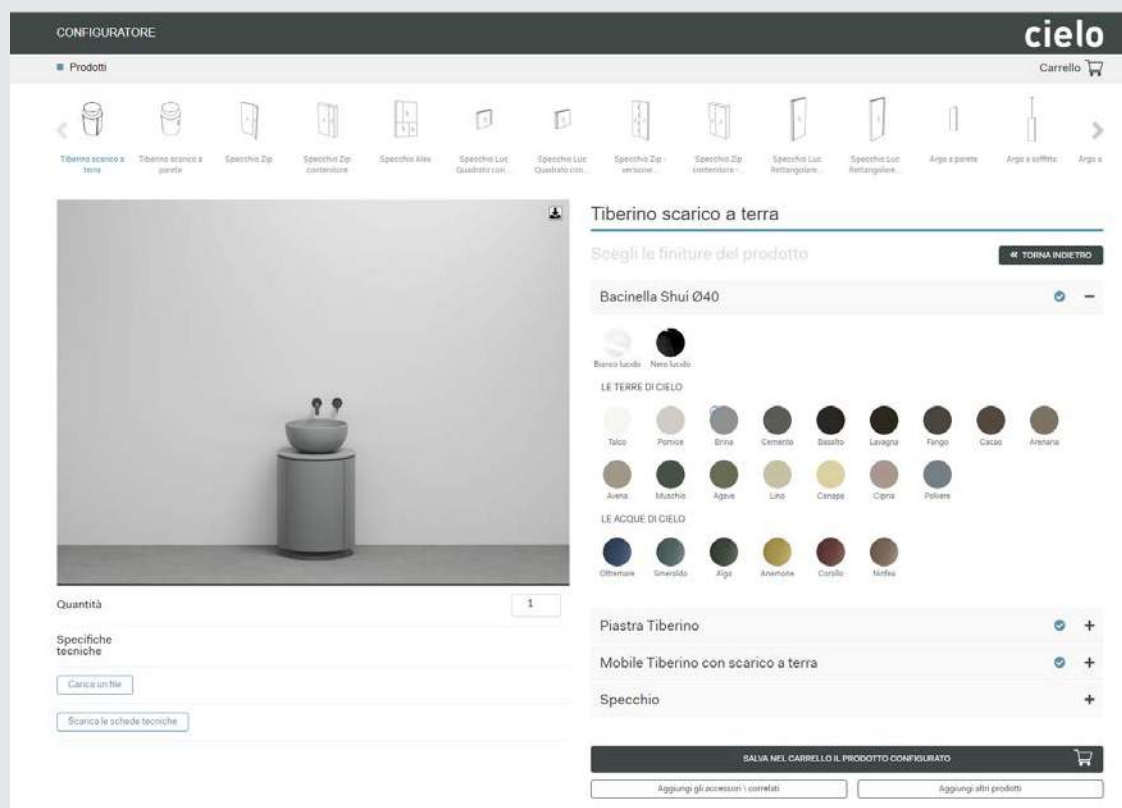

EN



go to the  
configurator

SP



ir al  
configurador

FR



lien vers le  
configurateur

RU

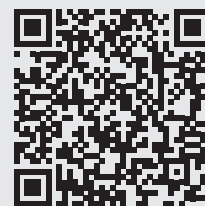

Перейдите в  
конфигуратор



## Finishes Tiberino cabinet

Acabado revestimiento Tiberino / Finitions Revêtement Tiberino / Ausführung Verkleidung Tiberino / Отделка для Tiberino

**lacquering** / *lacados* / *laquages* /  
*Lackierungen* / *Крашенная отделка*

**wood essences**

### Le Terre di Cielo

- |  |   |
|--|---|
|  TL - Talco    |  RS - Rovere Sbiancato |
|  PM - Pomice   |  RN - Rovere Naturale  |
|  BR - Brina    |  RG - Rovere Grigio    |
|  AN - Arenaria |  RO - Rovere Nero      |
|  AV - Avena    |   |
|  CM - Cemento  |   |
|  BA - Basalto  |   |
|  MU - Muschio  |   |

### Le Acque di Cielo

-  OL - Oltremare
-  SM - Smeraldo
-  AL - Alga
-  CO - Corallo
-  NI - Ninfea
-  AM - Anemone

## Plywood cladding finishes Cibeles bathtub

Acabado revestimiento bañera Cibeles / Finitions Revêtement vasque Cibeles / Ausführung Verkleidung Wanne Cibeles / Отделка для облицовки ванн Cibeles

**lacquering** / *lacados* / *laquages* /  
*Lackierungen* / *Крашенная отделка*

**wood essences**

### Le Terre di Cielo

- |  |   |
|--|---|
|  TL - Talco    |  RS - Rovere Sbiancato |
|  PM - Pomice   |  RN - Rovere Naturale  |
|  BR - Brina    |  RG - Rovere Grigio    |
|  AN - Arenaria |  RO - Rovere Nero      |
|  AV - Avena    |   |
|  CM - Cemento  |   |
|  BA - Basalto  |   |
|  MU - Muschio  |   |

## Available finish for Tiberino washbasin and top

Acabado lavabo y encimera Tiberino / Finitions lavabo et plaquette Tiberino / Ausführung Waschbecken und Platte Tiberino / Отделка раковины и пластин Tiberino

-  Glossy White

### Le Terre di Cielo

- |  |   |
|--|---|
|  TL - Talco   |  AN - Arenaria |
|  PM - Pomice  |  AV - Avena    |
|  BR - Brina   |  MU - Muschio  |
|  CM - Cemento |  AG - Agave    |
|  BA - Basalto |  LN - Lino     |
|  LV - Lavagna |  CN - Canapa   |
|  FN - Fango   |  CP - Cipria   |
|  CA - Cacao   |  PL - Polvere  |



### Le Acque di Cielo

-  OL - Oltremare
-  SM - Smeraldo
-  AL - Alga
-  CO - Corallo
-  NI - Ninfea
-  AM - Anemone

## LivingTec finishes Cibeles, Cibeles L, Dafne, Febe bath tubs

Acabado LivingTec bañera Cibeles, Cibeles L, Dafne, Febe / Finitions LivingTec vasque Cibeles, Cibeles L, Dafne, Febe / Ausführung Wanne Cibeles, Cibeles L, Dafne, Febe - LivingTec / Отделка ванн Cibeles, Cibeles L, Dafne, Febe - Livingtec

-  Matt White

-  Brina
-  Arenaria

The possible variations of the colour cannot be considered as defect, but as a guarantee of the completely artisan manufacturing of this unique and high quality product.

*Las variaciones de colores no se consideran un defecto sino una garantía de una elaboración manual y artesanal en un producto único y de calidad.*

*Les éventuelles variations de couleur ne peuvent être considérées comme des défauts, elles témoignent en revanche d'une méthode de travail totalement manuelle et artisanale employée pour obtenir un produit fini unique et de qualité.*

*Eventuelle Farbvariationen sind nicht als Mangel anzusehen, sondern als Garantie für die komplett handwerkliche Anfertigung eines einzigartigen und hochqualitativen Produkts.*

*Возможные вариации цвета не могут считаться дефектом, а являются подтверждением ручной работы, гарантией качества и уникальности изделия.*

## Cabinet | muebles | meubles | Möbel | мебель

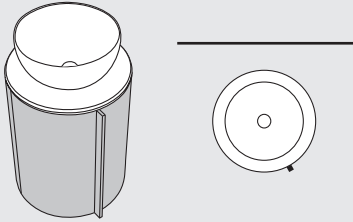

### Tiberino

**cabinet with floor trap** / meuble Tiberino avec sortie au sol / Tiberino moebel Abgang senkrecht mit Plan / Tiberino - отдельная тумба с топом и раковиной из terre di Cielo, со сливом в пол

#### TIM0BC

50 x 50 x h67  
pag. 334

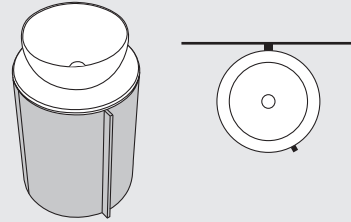

### Tiberino

**cabinet with wall trap** / meuble avec sortie au mur / Moebel Abgang waagrecht / Tiberino - отдельная тумба с топом и раковиной из terre di Cielo, со сливом в стену

#### TIM0BP

50 x 50 x h67  
pag. 334

## Bath tubs | cuve | Wanne | ванна

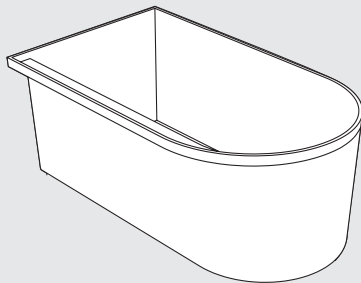

### Febe

140 x 80 x 57h  
pag. 339

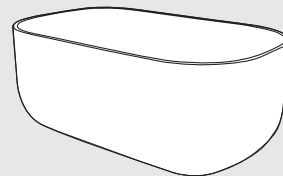

### Dafne

130 x 80 x 55h  
pag. 339

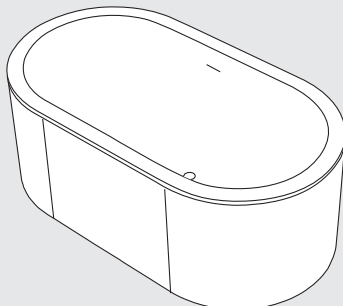

### Cibeles

160 x 86,5 x 61 h  
pag. 338

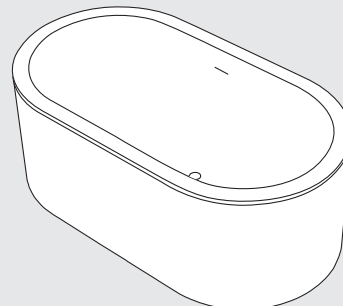

### Cibeles L

160 x 86,5 x 61 h  
pag. 339





## Mirrors | espejos | miroirs | Spiegel | зеркала

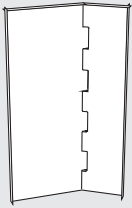

**Zip**

**SPZIPGDX/SPZIPGSX**  
66 x 4,5 x 110 h  
pag. 342

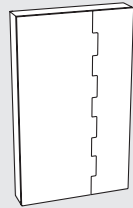

**Zip contenitore**

**SPZIPGDXC/SPZIPGSXC**  
66 x 14 x 110 h  
pag. 342



**Alex**

**SPALX**  
68 x 16,5 x 105 h  
pag. 342



**Luc rettangolare**

**SPLURLDX/SPLURLSX**  
40 x 6 x 110h  
pag. 343



**Luc quadrato**

**SPLUQLDX/SPLUQLSX**  
40 x 6 x 40h  
pag. 343

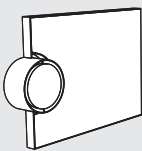

**Polifemo**

**POSPL**  
90 x 60  
pag. 349



**Pluto**

**PLSP/PLSPL**  
Ø40  
pag. 349



**Argo**

**ARSPSA/ARSPSAL**  
95 x 40  
pag. 348



**Argo**

**ARSP/ARSPL**  
95 x 40  
pag. 348



**Eos**

**SPEOL/SPEOBL**  
107 x 67 x 4  
pag. 345

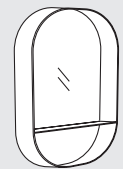

**Eos - c**

**SPEOML**  
107 x 67 x 4  
pag. 345

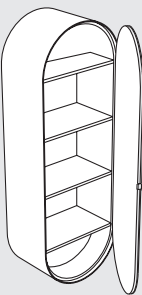

**Elio**

**SPELCL**  
145 x 50 x 31  
pag. 344

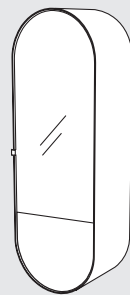

**Elio**

**SPELCLDX \ SPELCLSX**  
145 x 50 x 31  
pag. 344

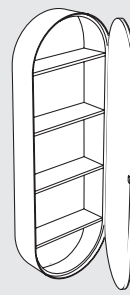

**Elio Slim**

**SPELSCL**  
145 x 50 x 15  
pag. 344

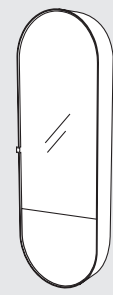

**Elio Slim**

**SPELSCLDX \ SPELSCLSX**  
145 x 50 x 15  
pag. 344

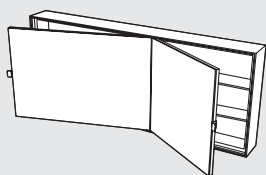
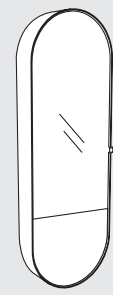

**Simple Box**

**SPSB**  
90 x 45 x 12  
pag. 345

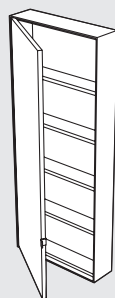

**Simple Tall Box**

**SPSTB**  
110 x 45 x 12  
pag. 345

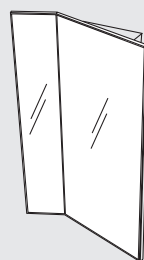

**Pan**

**SPPAN/SPPANL**  
73 x 17,5 x 110 h  
pag. 346

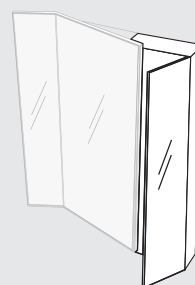

**Pan**

**SPPANCL**  
33 x 12,7 x 110 h  
pag. 347

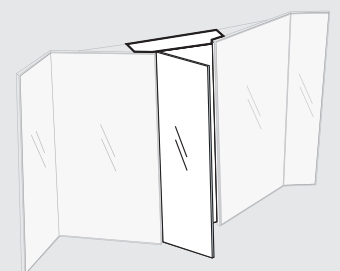

**Pan**

**SPPANCC**  
33 x 12,7 x 110 h  
pag. 347

## Available finishes for Zip mirrors

Acabado estructura espejo Zip / Finitions structure miroir Zip / Ausführung Spiegelrahmen Zip / Отделка каркаса зеркал Zip

**lacquering** / *lacados* / *laquages* / *Lackierungen* / *Крашенная отделка*

 **NM - Matt Black**

 **CM - Cemento**

 **BZ - Brushed Bronze**

### Le Acque di Cielo

**lacquering** / *lacados* / *laquages* / *Lackierungen* / *Крашенная отделка*

 **OL - Oltremare**

 **SM - Smeraldo**

 **AL - Alga**

 **CO - Corallo**

 **NI - Ninfea**

 **AM - Anemone**

## Available finishes for Alex mirrors

Acabado estructura espejo Alex / Finitions structure miroir Alex / Ausführung Spiegelrahmen Alex / Отделка каркаса зеркал Alex

**lacquering** / *lacados* / *laquages* / *Lackierungen* / *Крашенная отделка*

 **NM - Matt Black**

 **CM - Cemento**

**The possible variations of the colour cannot be considered as defect, but as a guarantee of the completely artisan manufacturing of this unique and high quality product.**

*Las variaciones de colores no se consideran un defecto sino una garantía de una elaboración manual y artesanal en un producto único y de calidad.*

*Les éventuelles variations de couleur ne peuvent être considérées comme des défauts, elles témoignent en revanche d'une méthode de travail totalement manuelle et artisanale employée pour obtenir un produit fini unique et de qualité.*

*Eventuelle Farbvariationen sind nicht als Mangel anzusehen, sondern als Garantie für die komplett handwerkliche Anfertigung eines einzigartigen und hochqualitativen Produkts.*

*Возможные вариации цвета не могут считаться дефектом, а являются подтверждением ручной работы, гарантией качества и уникальности изделия.*

## Available finishes for Argo, Pluto and Polifemo frame



Acabado estructura espejo Argo, Pluto, Polifemo / Finitions structure miroirs Argo, Pluto, Polifemo /  
Ausführung Spiegelrahmen Argo, Pluto, Polifemo / Отделка каркаса зеркал Argo, Pluto, Polifemo



**lacquering** / *lacados* / *laquages* / *Lackierungen* / *Крашенная отделка*

### Le Terre di Cielo

**\*metals** / *metales* / *métaux* /  
*Metalle* / *металлы*

**\*Matt Black, Brushed Bronze and Cemento are painted finishes** / Les finitions en Noir Mat, Bronze Brossé et Cemento doivent être considérées comme peinture / Die Oberflächen Schwarz Matt, gebürstet Bronze und Cemento sind aus Lack gefertigt / Matt Black, Brushed Bronze и Cemento являются покрытыми краской



-  TL - Talco
-  CM - Cemento

-  FE - Matt Black
-  BZ - Brushed Bronze

## Available finishes for Elio, Elio Slim, Eos-c frame

Acabado estructura espejo Elio, Elio Slim, Eos-c, /  
Finitions structure miroirs Elio, Elio Slim, Eos-c /  
Ausführung Spiegelrahmen Elio, Elio Slim, Eos-c /  
Отделка каркаса зеркал Elio, Elio Slim, Eos-c

**lacquering** / *lacados* / *laquages* / *Lackierungen* / *Крашенная отделка*



-  NM - Matt Black
-  CM - Cemento

## Available finishes for Tall Box, Simple Tall Box frame

Acabado estructura espejo Tall Box, Simple Tall Box /  
Finitions structure miroirs Tall Box, Simple Tall Box /  
Ausführung Spiegelrahmen Tall Box, Simple Tall Box /  
Отделка каркаса зеркал Tall Box, Simple Tall Box

**lacquering** / *lacados* / *laquages* /  
*Lackierungen* / *Крашенная отделка*

**Le Acque di Cielo**  
**lacquering** / *lacados* / *laquages* / *Lackierungen* / *Крашенная отделка*

-  NM - Matt Black
-  CM - Cemento
-  BZ - Brushed Bronze

-  OL - Oltremare
-  SM - Smeraldo
-  AL - Alga
-  CO - Corallo
-  NI - Ninfea
-  AM - Anemone

## Available finishes for Pan frame

Acabado estructura espejo Pan /  
Finitions structure miroirs Pan /  
Ausführung Spiegelrahmen Pan /  
Отделка каркаса зеркал Pan

**lacquering** / *lacados* / *laquages* / *Lackierungen* / *Крашенная отделка*

-  NM - Matt Black
-  IL - Gloss steel

The possible variations of the colour cannot be considered as defect, but as a guarantee of the completely artisan manufacturing of this unique and high quality product.

Las variaciones de colores no se consideran un defecto sino una garantía de una elaboración manual y artesanal en un producto único y de calidad.

Les éventuelles variations de couleur ne peuvent être considérées comme des défauts, elles témoignent en revanche d'une méthode de travail totalement manuelle et artisanale employée pour obtenir un produit fini unique et de qualité.

Eventuelle Farbvariationen sind nicht als Mangel anzusehen, sondern als Garantie für die komplett handwerkliche Anfertigung eines einzigartigen und hochqualitativen Produkts.

Возможные вариации цвета не могут считаться дефектом, а являются подтверждением ручной работы, гарантией качества и уникальности изделия.

# Tiberino



modelli disponibili / available models

## ARCADIA collection

### Tiberino

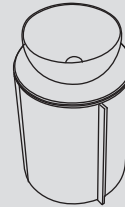

**mobile Tiberino  
freestanding con scarico  
a terra**  
Tiberino freestanding  
cabinet with floor trap

**50 x 50 x 85 h**  
TIMOBC



**mobile Tiberino  
freestanding con scarico a  
parete**  
Tiberino freestanding  
cabinet with wall trap

**50 x 50 x 85 h**  
TIMOBP

finiture / finishes

#### LAVABO E PIASTRA IN CERAMICA / CERAMIC WASHBASIN AND TOP

##### Le Terre di Cielo



SHBA40

##### Le Acque di Cielo



TIPI

#### MOBILE IN LEGNO / WOODEN CABINET

##### Le Terre di Cielo laccature / lacquers



##### essenze / wooden finishes

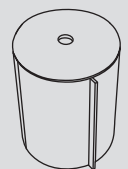
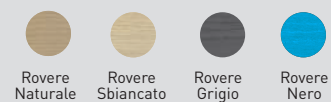

TIMOPC \ TIMOCC  
TIMOPE \ TIMOCE

##### Le Acque di Cielo laccature / lacquers



note tecniche lavabo / washbasin technical notes



**composizione obbligatoria: lavabo + top + mobile**  
mandatory combination: washbasin + top + cabinet



**con i lati tutti smaltati**  
all sides are enamelled



**senza foro**  
without hole



**senza troppopieno**  
without overflow

CLIENTE/client:  ORD. REF.:

QUANTITA'/quantity:  EMAIL:

art. **SHBA40**

**FINITURE LAVABO**

WASHBASIN FINISHES

Bianco/white - glossy

Le Terre di Cielo

- |                                    |                                     |
|------------------------------------|-------------------------------------|
| <input type="radio"/> TL - Talco   | <input type="radio"/> AN - Arenaria |
| <input type="radio"/> PM - Pomice  | <input type="radio"/> AV - Avena    |
| <input type="radio"/> BR - Brina   | <input type="radio"/> LN - Lino     |
| <input type="radio"/> BA - Basalto | <input type="radio"/> AG - Agave    |
| <input type="radio"/> LV - Lavagna | <input type="radio"/> MU - Muschio  |
| <input type="radio"/> CM - Cemento | <input type="radio"/> PL - Polvere  |
| <input type="radio"/> FN - Fango   | <input type="radio"/> CP - Cipria   |
| <input type="radio"/> CA - Cacao   | <input type="radio"/> CN - Canapa   |

Le Acque di Cielo

- |                                      |                                    |
|--------------------------------------|------------------------------------|
| <input type="radio"/> OL - Oltremare | <input type="radio"/> CO - Corallo |
| <input type="radio"/> SM - Smeraldo  | <input type="radio"/> NI - Ninfea  |
| <input type="radio"/> AL - Alga      | <input type="radio"/> AM - Anemone |

art. **TIPI**

**FINITURE PIANO IN CERAMICA**

CERAMIC SHELF FINISHES

Bianco/white - glossy

Le Terre di Cielo

- |                                    |                                     |
|------------------------------------|-------------------------------------|
| <input type="radio"/> TL - Talco   | <input type="radio"/> AN - Arenaria |
| <input type="radio"/> PM - Pomice  | <input type="radio"/> AV - Avena    |
| <input type="radio"/> BR - Brina   | <input type="radio"/> LN - Lino     |
| <input type="radio"/> BA - Basalto | <input type="radio"/> AG - Agave    |
| <input type="radio"/> LV - Lavagna | <input type="radio"/> MU - Muschio  |
| <input type="radio"/> CM - Cemento | <input type="radio"/> PL - Polvere  |
| <input type="radio"/> FN - Fango   | <input type="radio"/> CP - Cipria   |
| <input type="radio"/> CA - Cacao   | <input type="radio"/> CN - Canapa   |

Le Acque di Cielo

- |                                      |                                    |
|--------------------------------------|------------------------------------|
| <input type="radio"/> OL - Oltremare | <input type="radio"/> CO - Corallo |
| <input type="radio"/> SM - Smeraldo  | <input type="radio"/> NI - Ninfea  |
| <input type="radio"/> AL - Alga      | <input type="radio"/> AM - Anemone |

 **Tiberino con scarico a parete**  
Tiberino with wall trap

art. **TIMOPC/TIMOPE**

**FINITURE MOBILE**

CABINET FINISHES

laccature/laquerings

Le Terre di Cielo

- |                                  |                                    |                                    |                                     |
|----------------------------------|------------------------------------|------------------------------------|-------------------------------------|
| <input type="radio"/> TL - Talco | <input type="radio"/> PM - Pomice  | <input type="radio"/> BR - Brina   | <input type="radio"/> AN - Arenaria |
| <input type="radio"/> AV - Avena | <input type="radio"/> CM - Cemento | <input type="radio"/> BA - Basalto | <input type="radio"/> MU - Muschio  |

Le Acque di Cielo

- |                                      |                                     |                                    |
|--------------------------------------|-------------------------------------|------------------------------------|
| <input type="radio"/> OL - Oltremare | <input type="radio"/> SM - Smeraldo | <input type="radio"/> AL - Alga    |
| <input type="radio"/> CO - Corallo   | <input type="radio"/> NI - Ninfea   | <input type="radio"/> AM - Anemone |

essenze legno/wood essences

- |  |   |
|--|---|
| <input type="radio"/> RO - Rovere Nero   | <input type="radio"/> RS - Rovere Sbiancato |
| <input type="radio"/> RG - Rovere Grigio | <input type="radio"/> RN - Rovere Naturale  |

 **Tiberino con scarico a terra**  
Tiberino with floor trap

art. **TIMOCC/TIMOCE**

**FINITURE MOBILE**

CABINET FINISHES

laccature/laquerings

Le Terre di Cielo

- |                                  |                                    |                                    |                                     |
|----------------------------------|------------------------------------|------------------------------------|-------------------------------------|
| <input type="radio"/> TL - Talco | <input type="radio"/> PM - Pomice  | <input type="radio"/> BR - Brina   | <input type="radio"/> AN - Arenaria |
| <input type="radio"/> AV - Avena | <input type="radio"/> CM - Cemento | <input type="radio"/> BA - Basalto | <input type="radio"/> MU - Muschio  |

Le Acque di Cielo

- |                                      |                                     |                                    |
|--------------------------------------|-------------------------------------|------------------------------------|
| <input type="radio"/> OL - Oltremare | <input type="radio"/> SM - Smeraldo | <input type="radio"/> AL - Alga    |
| <input type="radio"/> CO - Corallo   | <input type="radio"/> NI - Ninfea   | <input type="radio"/> AM - Anemone |

essenze legno/wood essences

- |  |   |
|--|---|
| <input type="radio"/> RO - Rovere Nero   | <input type="radio"/> RS - Rovere Sbiancato |
| <input type="radio"/> RG - Rovere Grigio | <input type="radio"/> RN - Rovere Naturale  |

**DATA**

DATE

**FIRMA DEL CLIENTE**

SIGNATURE

ATTENZIONE:  
La rappresentazione delle finiture è puramente indicativa. Verificare le finiture con le relative cartelle.

Ogni oggetto possiede la peculiarità di essere elaborato secondo principi puramente tradizionali, in modo da garantirne l'assoluta originalità ed unicità. Le eventuali piccole variazioni di colore, tono o venature fra gli articoli sono da considerarsi pregi e non difetti, in quanto garanzia della fattura manuale del prodotto, che fa di ogni oggetto Cielo un pezzo unico ed esclusivo, lontano dall'omologazione industriale. In fase d'ordine si intendono, pertanto, accettate tali tolleranze che non possono dare adito a contestazioni di alcun genere.

Verificare sempre le disponibilità e i tempi di consegna con il commerciale.

ATTENTION:  
The representation of the finishes is merely indicative. Please choose the finishes using the folders.

Every item possesses that particular feature of being processed according to purely traditional principles that guarantee its absolute originality and uniqueness. The small variations in colour, hues or streaks on the items are to be considered as qualities and not defects, since they warranty the handcrafted processing which makes each Cielo item a unique and exclusive piece that cannot be compared to industrial standardization. When making the order, the client implicitly accepts those various features that may give rise to claims of any sort.

Always check the availability and delivery time with the commercial department.























	<b>Size (cm)</b> Medidas Dimensions Maße Размеры	<b>Product code</b> Artículo Article Artikel Артикул	<b>Net weight (kg)</b> Peso neto Poids net Reingewicht вес нетто	<b>Finishes</b> Acabados Finitions Farbe Отделки	<b>Euro</b> Евро	<b>Pz.</b> шт. pallet Italia	<b>Pz.</b> шт. pallet Cont.
	Ø50 x 67 h						
 <p><b>Shui on top bowl without overflow Ø40</b>                      Lavabo de apoyo Shui de cerámica Lavabo de apoyo Shui sin demasiado lleno Ø40                      Vasque à poser Shui sans trop plein Ø40                      Aufsatzbecken ohne Überlauf Ø40 Shui                      Накладная чаша без переливом Ø40 Shui</p>	Ø40 x 18,5 h	SHBA40(X)*	8,55	<ul style="list-style-type: none"> <li> <b>Gloss White</b></li> <li> <b>Le Terre di Cielo</b></li> <li> <b>Le Acque di Cielo</b></li> </ul>	427,00		
 <p><b>Ceramic top for Tiberino cabinet (mandatory)</b>                      Encimera ceramica para mueble Tiberino (obligatoria)                      Plaque en céramique pour meuble Tiberino (nécessaire)                      Plan aus Keramik fuer Tiberino Moebel (geböten)                      Плита керамическая для тумбы под раковину Tiberino (обязательный)</p>	Ø50 x 1,8 h	TIPI(X)*	6,80	<ul style="list-style-type: none"> <li> <b>Gloss White</b></li> <li> <b>Le Terre di Cielo</b></li> <li> <b>Le Acque di Cielo</b></li> </ul>	239,00		
 <p><b>Cabinet with floor trap</b>                      Mueble con salida a suelo                      Meuble Tiberino avec sortie au sol                      Tiberino moebel Abgang senkrecht mit Plan                      Тумба со сливом в пол</p>	Ø50 x 65 h	TIMOCC(X)*	21,00	<ul style="list-style-type: none"> <li> <b>Le Terre di Cielo*</b></li> <li> <b>Le Acque di Cielo°</b></li> </ul>	1918,00		
	Ø50 x 65 h	TIMOCE(X)*	21,00	<p><b>EsSENze</b></p> <ul style="list-style-type: none"> <li> *X = RN - Rovere Naturale</li> <li> *X = RS - Rovere Sbiancato</li> <li> *X = RO - Rovere Nero</li> <li> *X = RG - Rovere Grigio</li> </ul>	2183,00		
 <p><b>Cabinet with wall trap</b>                      Mueble con salida a pared                      Meuble avec sortie au mur                      Moebel Abgang waagerecht                      Тумба со сливом в стену</p> <p><b>mandatory combination: washbasin + top + cabinet</b>                      combinaison obligatoire: cubela + encimera + mueble \ combinación obligatoria: vasque + plan + meuble \ obligatorische Kombination: Aufsatzbecken + Holzregal + Möbel \ обязательное сочетание: Накладная + столешница + Тумба</p>	Ø50 x 65 h	TIMOPC(X)*	20,90	<ul style="list-style-type: none"> <li> <b>Le Terre di Cielo*</b></li> <li> <b>Le Acque di Cielo°</b></li> </ul>	1918,00		
	Ø50 x 65 h	TIMOPE(X)*	20,90	<p><b>EsSENze</b></p> <ul style="list-style-type: none"> <li> *X = RN - Rovere Naturale</li> <li> *X = RS - Rovere Sbiancato</li> <li> *X = RO - Rovere Nero</li> <li> *X = RG - Rovere Grigio</li> </ul>	2183,00		

# Tiberino

# cielo

drains and siphons | desagües y sifones | les drains et les siphons | Ablaufgarnituren und Siphons | Донные клапаны и сифоны

	Product code Artículo Article Artikel Артикул	Net weight (Kg) Peso neto Poids net Reingewicht вес нетто	Finishes Acabados Finitions Farbe Отделки	Euro Евро
 <p><b>Universal click/clack drain in CHROME with ceramic lid</b> Válvula universal click/clack Cromado con tapa en cerámica Bonde universelle clic/clac Chromé avec clapet en céramique Universal-Abflussgarnitur Click-Clack Chrom mit Keramikstopfen Универсальный дренажный клапан click/clack хром с керамической крышкой</p>	PIL01(X)*	0,40	 <b>Gloss White</b>	<b>95,00</b>
			 <b>Le Terre di Cielo</b>	<b>139,00</b>
			 <b>Le Acque di Cielo</b>	<b>139,00</b>
 <p><b>Universal click/clack drain in BLACK MATT finish with ceramic lid</b> Válvula universal click/clack Negro Matt con tapa en cerámica Bonde universelle clic/clac Noir Mat avec clapet en céramique Universal-Abflussgarnitur Click-Clack Matt Schwarz mit Keramikstopfen Универсальный дренажный клапан click/clack черный матовый с керамической крышкой</p>	PIL01NM(X)*	0,40	 <b>Gloss White</b>	<b>120,00</b>
			 <b>Le Terre di Cielo</b>	<b>169,00</b>
			 <b>Le Acque di Cielo</b>	<b>169,00</b>
 <p><b>Universal click/clack drain in CEMENTO finish with ceramic lid</b> Válvula universal click/clack Cemento con tapa en cerámica Bonde universelle clic/clac Cimento avec clapet en céramique Universal-Abflussgarnitur Click-Clack Cement mit Keramikstopfen Универсальный дренажный Cimento click/clack с керамической крышкой</p>	PIL01CM(X)*	0,40	 <b>Gloss White</b>	<b>120,00</b>
			 <b>Le Terre di Cielo</b>	<b>169,00</b>
			 <b>Le Acque di Cielo</b>	<b>169,00</b>
 <p><b>Universal click/clack drain in BRONZE with ceramic lid</b> Válvula universal click/clack Bronce con tapa en cerámica Bonde universelle clic/clac Bronze avec clapet en céramique Universal-Abflussgarnitur Click-Clack Bronze mit Keramikstopfen Универсальный дренажный клапан click/clack бронза с керамической крышкой</p>	PIL01BR(X)*	0,40	 <b>Gloss White</b>	<b>135,00</b>
			 <b>Le Terre di Cielo</b>	<b>182,00</b>
			 <b>Le Acque di Cielo</b>	<b>182,00</b>
 <p><b>Connector and joint for Tiberino cabinet (mandatory)</b> Extensión y anillo para el mueble Tiberino (obligatorio) Rallonge et opercule pour meuble Tiberino (nécessaire) Ring und Drain-Erweiterung für Tiberino (geböten) Удлинитель и кольцо для тумбы под раковину Tiberino (обязательный)</p>	PROTIB	0,25		<b>62,00</b>
 <p><b>Siphon for floor drain for Tiberino cabinet (mandatory)</b> Sifón con salida a suelo para mueble Tiberino (obligatorio) Siphon avec sortie au sol pour meuble Tiberino (nécessaire) Siphon Abgang senkrecht für Tiberino Möbel (geböten) Сифон для слива в пол (обязательный)</p>	SIFTIBC	1,38	 <b>Chrome</b>	<b>185,00</b>
 <p><b>Siphon for wall drain for Tiberino cabinet (recommended)</b> Sifón con salida a pared para mueble Tiberino (aconsejado) Siphon sortie au mur pour meuble Tiberino (informé) Siphon Abgang waagrecht für Tiberino Möbel (empfohlen) Сифон для слива в стену (рекомендуется)</p>	SIFTIB	0,93	 <b>Chrome</b>	<b>143,00</b>

Terre\Acque di Cielo available for washbasin and top | Terre\Acque di Cielo disponibles para lavabo de cerámica y encimera cerámica | Terre\Acque di Cielo disponibles pour le lavabo et le plaque en céramique | Für Waschbecken und Keramikplatte erhältliche Terre\Acque di Cielo | Отделка Terre\Acque di Cielo доступны для раковины и керамических столешниц





- Le Terre di Cielo  TL - Talco  PM - Pomice  BR - Brina  BA - Basalto  LV - Lavagna  CM - Cemento  FN - Fango  CA - Cacao
-  AN - Arenaria  AV - Avena  LN - Lino  AG - Agave  MU - Muschio  PL - Polvere  CP - Cipria  CN - Canapa
- Le Acque di Cielo  OL - Oltremare  SM - Smeraldo  AL - Alga  CO - Corallo  NI - Ninfea  AM - Anemone

Terre\Acque di Cielo laquering available for cabinet | lacado Terre\Acque di Cielo disponible para muebles | laquages Terre\Acque di Cielo disponibles pour le meuble | Für das Möbel erhältliche Lackierungen Terre\Acque di Cielo | крашенная отделка Terre\Acque di Cielo доступна для мебели

- Le Terre di Cielo\*  TL - Talco  PM - Pomice  BR - Brina  AN - Arenaria  AV - Avena  CM - Cemento  BA - Basalto  MU - Muschio
- Le Acque di Cielo°  OL - Oltremare  SM - Smeraldo  AL - Alga  CO - Corallo  NI - Ninfea  AM - Anemone

## Technical symbols legend

Simbolos técnicos clave | Légende symboles techniques | Technische Zeichenerklärung | Перечень технических символов

-  all sides are enamelled  
con todos los lados esmaltados  
avec tous les côtés émaillés  
alle Seiten glasiert  
все стороны покрыты эмалью
-  no tap holes  
sin agujero para grifo  
sans orifice robinet  
ohne Hahnloch  
без отверстия под смеситель
-  without overflow  
sin rebosadero  
sans trop-plein  
ohne Überlauf  
без слива-перелива
-  on top installation  
instalación de apoyo  
installation de appui  
Montage auf Platte  
установка на столешницу







### LivingTec bathtub

Bañera de LivingTec  
Baignoire in LivingTec  
Badewanne aus livingtec  
ванна LivingTec

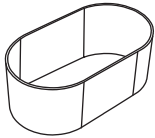

### Okume marine plywood cladding - lacquered

Revestido en contrachapado marino Okume lacado  
Revêtement en multicouche marin Okumè laqué  
Verkleidung wasserfeste Mehrschichtplatte Okumè lackiert  
блицовка из крашенной морской фанеры Окуме

### Okume marine plywood cladding - wood essence

Revestido en contrachapado marino Okume en madera  
Revêtement en multicouche marin Okumè en essence de bois  
Verkleidung wasserfeste Mehrschichtplatte Okumè Holz  
Облицовка из морской фанеры Окуме с отделкой натуральным шпоном



### Bathtub waste (mandatory)

Sistema de descarga para bañera (obligatorio)  
Système de chasse pour baignoire (nécessaire)  
Ablaufgarnitur für Badewanne (geböten)  
Выхлопная система для ванна (обязательный)

Size (cm)	Product code	Net weight(Kg)	Finishes	Euro	Pz.	Pz.
Medidas Dimensions Maße Размеры	Artículo Article Artikel Артикул	Peso neto Poids net Reingewicht вес нетто	Acabados Finitions Farbe Отделки	Евро	шт. pallet Italia	шт. pallet Cont.
160 x 86 x 61 h		118,50				
	CIBELE(x)*	75,00	<ul style="list-style-type: none"> <li><span style="display: inline-block; width: 10px; height: 10px; background-color: #f0f0f0; border-radius: 50%; margin-right: 5px;"></span> Matt White</li> <li><span style="display: inline-block; width: 10px; height: 10px; background-color: #444; border-radius: 50%; margin-right: 5px;"></span> Brina</li> <li><span style="display: inline-block; width: 10px; height: 10px; background-color: #663; border-radius: 50%; margin-right: 5px;"></span> Arenaria</li> </ul>	5116,00 7346,00 7346,00		
	CIBATC(x)*	43,50	<ul style="list-style-type: none"> <li><span style="display: inline-block; width: 10px; height: 10px; background-color: #663; border-radius: 50%; margin-right: 5px;"></span> Le Terre di Cielo *</li> </ul> <hr style="border-top: 1px dashed black;"/> <p><b>Essenze</b></p> <ul style="list-style-type: none"> <li><span style="display: inline-block; width: 10px; height: 10px; background-color: #663; border-radius: 50%; margin-right: 5px;"></span> *X = RN - Rovere Naturale</li> <li><span style="display: inline-block; width: 10px; height: 10px; background-color: #996; border-radius: 50%; margin-right: 5px;"></span> *X = RS - Rovere Sbiancato</li> <li><span style="display: inline-block; width: 10px; height: 10px; background-color: #000; border-radius: 50%; margin-right: 5px;"></span> *X = RO - Rovere Nero</li> <li><span style="display: inline-block; width: 10px; height: 10px; background-color: #333; border-radius: 50%; margin-right: 5px;"></span> *X = RG - Rovere Grigio</li> </ul>	3018,00   3412,00		
	SHCOMEC	0,40		131,00		

### ! Mandatory combination: bathtub + plywood cladding

combinaison obligatoire: bañera + contrachapado  
Combinación obligatoria: baignoire + revêtement  
obligatorische Kombination: Badewanne + Verkleidung  
обязательное сочетание: ванна + Облицовка

\* Terre di Cielo laquering available for covering /  
lacados Terre di Cielo disponibles para revestimiento /  
laquages Terre di Cielo disponibles pour le revêtement /  
Für die Verkleidung erhältliche Lackierungen Terre di Cielo /  
крашенная отделка Terre di Cielo доступна для облицовки



TL - Talco
  PM - Pomice
  BR - Brina
  AN - Arenaria
  AV - Avena
  CM - Cemento
  BA - Basalto
  MU - Muschio



# Cibele L, Febe, Dafne

# cielo

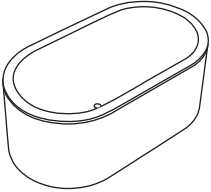
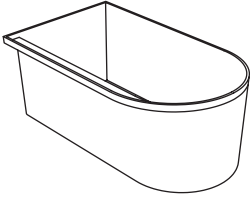
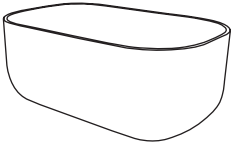
bath tubs | baignoire | Badewanne | Ванна

	Size (cm)	Product code	Net weight (Kg)	Finishes	Euro	Pz.	Pz.
	Medidas Dimensions Maße Размеры	Artículo Article Artikel Артикул	Peso neto Poids net Reingewicht вес нетто	Acabados Finitions Farbe Отделки	Евро	шт. pallet Italia	шт. pallet Cont.
 <p><b>Cibele L bathtub in LivingTec, monocoque</b>                      Bañera Cibele L in LivingTec, pieza única                      Baignoire Cibele L en LivingTec, monobloc                      Wanne Cibele L aus LivingTec, Monocoque                      Ванна Cibele L из материала LivingTec, с моноблочной облицовкой</p>	160 x 86 x 61 h	CIBELEL(X)*	130,00	<ul style="list-style-type: none"> <li><span style="display: inline-block; width: 10px; height: 10px; background-color: #e0e0e0; border-radius: 50%; margin-right: 5px;"></span> Matt White</li> <li><span style="display: inline-block; width: 10px; height: 10px; background-color: #666666; border-radius: 50%; margin-right: 5px;"></span> Brina</li> <li><span style="display: inline-block; width: 10px; height: 10px; background-color: #808080; border-radius: 50%; margin-right: 5px;"></span> Arenaria</li> </ul>	5464,00 8220,00 8220,00		
 <p><b>Febe bathtub in LivingTec</b>                      Bañera Febe in LivingTec                      Baignoire Febe en LivingTec                      Wanne Febe aus LivingTec                      Ванна Febe из материала LivingTec</p>	140 x 80 x 57 h	FEBAT(X)*	118,00	<ul style="list-style-type: none"> <li><span style="display: inline-block; width: 10px; height: 10px; background-color: #e0e0e0; border-radius: 50%; margin-right: 5px;"></span> Matt White</li> <li><span style="display: inline-block; width: 10px; height: 10px; background-color: #666666; border-radius: 50%; margin-right: 5px;"></span> Brina</li> <li><span style="display: inline-block; width: 10px; height: 10px; background-color: #808080; border-radius: 50%; margin-right: 5px;"></span> Arenaria</li> </ul>	4699,00 6814,00 6814,00		
 <p><b>Dafne bathtub in LivingTec</b>                      Bañera Dafne in LivingTec                      Baignoire Dafne en LivingTec                      Wanne Dafne aus LivingTec                      Ванна Dafne из материала LivingTec</p>	130 x 80 x 55 h	DABAT(X)*	108,00	<ul style="list-style-type: none"> <li><span style="display: inline-block; width: 10px; height: 10px; background-color: #e0e0e0; border-radius: 50%; margin-right: 5px;"></span> Matt White</li> <li><span style="display: inline-block; width: 10px; height: 10px; background-color: #666666; border-radius: 50%; margin-right: 5px;"></span> Brina</li> <li><span style="display: inline-block; width: 10px; height: 10px; background-color: #808080; border-radius: 50%; margin-right: 5px;"></span> Arenaria</li> </ul>	4190,00 6076,00 6076,00		
 <p><b>Bathtub waste (mandatory)</b>                      Sistema de descarga para bañera (obligatorio)                      Système de chasse pour baignoire (nécessaire)                      Ablaufgarnitur für Badewanne (geböten)                      Выхлопная система для ванна (обязательный)</p>		SHCOME C	0,40		131,00		









# Arcadia - Zip & Alex

mirrors / miroirs / Spiegel / зеркала

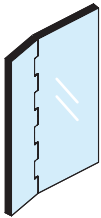
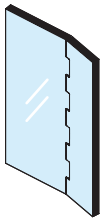
# cielo

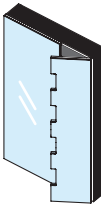
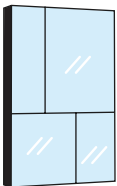
	Size (cm) Medidas Dimensions Maße Размеры	Product code Artículo Article Artikel Артикул	Net weight (Kg) Peso neto Poids net Reingewicht вес нетто	Finishes Acabados Finitions Farbe Отделки	Euro Espo
 <p><b>Zip mirror right</b> Espejo Zip bien / Miroir Zip droit / Spiegel Zip Rechts / зеркало Zip верно</p>	66 x 4,4 x 110 h	SPZIPGDY	25,50	<ul style="list-style-type: none"> <li><span style="display: inline-block; width: 10px; height: 10px; background-color: black; border-radius: 50%; margin-right: 5px;"></span> *X = NM - Matt Black</li> <li><span style="display: inline-block; width: 10px; height: 10px; background-color: gray; border-radius: 50%; margin-right: 5px;"></span> *X = CM - Cemento</li> <li><span style="display: inline-block; width: 10px; height: 10px; background-color: #8B4513; border-radius: 50%; margin-right: 5px;"></span> *X = BZ - Brushed Bronze</li> <li><span style="display: inline-block; width: 10px; height: 10px; background-color: #008080; border-radius: 50%; margin-right: 5px;"></span> *X = Le Acque di Cielo</li> </ul>	<p>1889,00</p> <p>2040,00</p> <p>2160,00</p> <p>2409,00</p>
 <p><b>Zip mirror left</b> Espejo Zip izquierda / Miroir Zip gauche / Spiegel Zip links / зеркало Zip левый</p>	66 x 4,4 x 110 h	SPZIPGSX	25,50	<ul style="list-style-type: none"> <li><span style="display: inline-block; width: 10px; height: 10px; background-color: black; border-radius: 50%; margin-right: 5px;"></span> *X = NM - Matt Black</li> <li><span style="display: inline-block; width: 10px; height: 10px; background-color: gray; border-radius: 50%; margin-right: 5px;"></span> *X = CM - Cemento</li> <li><span style="display: inline-block; width: 10px; height: 10px; background-color: #8B4513; border-radius: 50%; margin-right: 5px;"></span> *X = BZ - Brushed Bronze</li> <li><span style="display: inline-block; width: 10px; height: 10px; background-color: #008080; border-radius: 50%; margin-right: 5px;"></span> *X = Le Acque di Cielo</li> </ul>	<p>1889,00</p> <p>2040,00</p> <p>2160,00</p> <p>2409,00</p>
 <p><b>Mirror Zip right container</b> Espejo Zip bien contenedor / Miroir avec rangement droit Zip / Spiegelschrank Zip Rechts / Зеркальный верно шкафчик Zip</p>	66 x 14 x 110 h	SPZIPGDYC	33,00	<ul style="list-style-type: none"> <li><span style="display: inline-block; width: 10px; height: 10px; background-color: black; border-radius: 50%; margin-right: 5px;"></span> *X = NM - Matt Black</li> <li><span style="display: inline-block; width: 10px; height: 10px; background-color: gray; border-radius: 50%; margin-right: 5px;"></span> *X = CM - Cemento</li> <li><span style="display: inline-block; width: 10px; height: 10px; background-color: #8B4513; border-radius: 50%; margin-right: 5px;"></span> *X = BZ - Brushed Bronze</li> <li><span style="display: inline-block; width: 10px; height: 10px; background-color: #008080; border-radius: 50%; margin-right: 5px;"></span> *X = Le Acque di Cielo</li> </ul>	<p>2518,00</p> <p>2661,00</p> <p>2809,00</p> <p>3108,00</p>
 <p><b>Mirror Zip left container</b> Espejo Zip izquierda contenedor / Miroir gauche avec rangement Zip / Spiegelschrank Zip links / Зеркальный левый шкафчик Zip</p>	66 x 14 x 110 h	SPZIPGSXC	33,00	<ul style="list-style-type: none"> <li><span style="display: inline-block; width: 10px; height: 10px; background-color: black; border-radius: 50%; margin-right: 5px;"></span> *X = NM - Matt Black</li> <li><span style="display: inline-block; width: 10px; height: 10px; background-color: gray; border-radius: 50%; margin-right: 5px;"></span> *X = CM - Cemento</li> <li><span style="display: inline-block; width: 10px; height: 10px; background-color: #8B4513; border-radius: 50%; margin-right: 5px;"></span> *X = BZ - Brushed Bronze</li> <li><span style="display: inline-block; width: 10px; height: 10px; background-color: #008080; border-radius: 50%; margin-right: 5px;"></span> *X = Le Acque di Cielo</li> </ul>	<p>2518,00</p> <p>2661,00</p> <p>2809,00</p> <p>3108,00</p>
 <p><b>Alex mirror</b> Espejo Alex / Miroir Alex / Spiegel Alex / зеркало Alex</p>	68 x 16,5 x 105 h	SPALX	29,00	<ul style="list-style-type: none"> <li><span style="display: inline-block; width: 10px; height: 10px; background-color: black; border-radius: 50%; margin-right: 5px;"></span> *X = NM - Matt Black</li> <li><span style="display: inline-block; width: 10px; height: 10px; background-color: gray; border-radius: 50%; margin-right: 5px;"></span> *X = CM - Cemento</li> </ul>	<p>1772,00</p> <p>1772,00</p>

Le Acque di Cielo



OL - Oltremare



SM - Smeraldo



AL - Alga



CO - Corallo



NI - Ninfea



AM - Anemone

# Arcadia - Luc

mirrors / miroirs / Spiegel / зеркала



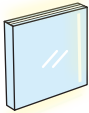
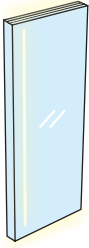
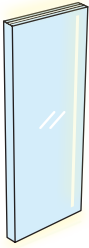

# cielo

	Size (cm) Medidas Dimensions Maße Размеры	Product code Artículo Article Artikel Артикул	Net weight (Kg) Peso neto Poids net Reingewicht вес нетто	Finishes Acabados Finitions Farbe Отделки	Euro Евро
 <p><b>Mirror Luc square with left-side light</b> Espejo Luc Cuadrado con luz izquierda / Miroir Luc carré avec lumière à gauche / Quadratischer Spiegel Luc mit Beleuchtung links / Зеркало Luc квадратное с подсветкой слева</p>	40 x 6 x 40 h	SPLUQLSX	7,50		1001,00
 <p><b>Mirror Luc square with right-side light</b> Espejo Luc Cuadrado ccon luz derecha / Miroir Luc carré avec lumière à droite / Quadratischer Spiegel Luc mit Beleuchtung links / Зеркало Luc квадратное с подсветкой справа</p>	40 x 6 x 40 h	SPLUQLDX	7,50		1001,00
 <p><b>Mirror Luc rectangular with left-side light</b> Espejo Luc Rectangular con luz izquierda / Miroir Luc rectangulaire avec lumière à gauche / Quadratischer Spiegel Luc mit Beleuchtung links / Зеркало Luc прямоугольное с подсветкой слева</p>	40 x 6 x 110 h	SPLURLSX	18,00		1229,00
 <p><b>Mirror Luc rectangular with right-side light</b> Espejo Luc Rectangular con luz derecha / Miroir Luc rectangulaire avec lumière à droite / Rechteckiger Spiegel Luc mit Beleuchtung rechts / Зеркало Luc прямоугольное с подсветкой справа</p>	40 x 6 x 40 h	SPLURLDX	18,00		1229,00

# Arcadia - Elio & Elio Slim

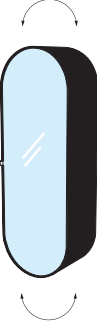
mirrors / miroirs / Spiegel / зеркала

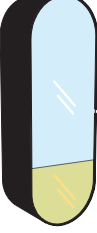

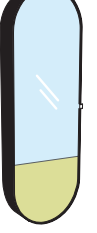

# cielo

	Size (cm) Medidas Dimensions Maße Размеры	Product code Artículo Article Artikel Артикул	Net weight (kg) Peso neto Poids net Reingewicht вес нетто	Finishes Acabados Finitions Farbe Отделки	Euro
 <p><b>Elio</b> <b>Reversible Cabinet mirror, can be hung on either the left or right side, with lacquered shell</b> Espejo contenedor reversible dcha/izda., con capa lacada / Miroir armoire de toilette reversible dx/sx structure laquée / Spiegelschrank reversibel re./li., Korpus lackiert / Зеркальный шкафчик реверсивный dx/sx с крашенным корпусом</p>	50 x 31 x 145 h	SPELCL	61,00	<ul style="list-style-type: none"> <li>● *X = NM - Matt Black</li> <li>● *X = CM - Cemento</li> </ul>	<p>2299,00</p> <p>2488,00</p>
 <p><b>Elio</b> <b>Cabinet Mirror with lacquered shell and bicolour glass (bottom mirror gold) right side opening</b> Espejo contenedor con capa lacada y cristal bicolor (porción baja oro), apertura derecha / Miroir armoire de toilette structure laquée et verre bicolore (partie basse or) ouverture droite / Spiegelschrank mit lackiertem Korpus und zweifarbigem Glas (unterer Teil Gold), Öffnung rechts / Зеркальный шкафчик с крашенным корпусом и двухцветным зеркалом (нижняя часть – oro), открывание справа</p>	50 x 31 x 145 h	SPELCLDX	61,00	<ul style="list-style-type: none"> <li>● *X = NO - Black\Gold</li> <li>● *X = OC - Cemento\Gold</li> </ul>	<p>2368,00</p> <p>2611,00</p>
 <p><b>Elio</b> <b>Cabinet mirror with lacquered shell and bicolour glass (bottom mirror gold) left side opening</b> Espejo contenedor con capa lacada y cristal bicolor (porción baja oro), apertura izquierda / Miroir armoire de toilette structure laquée et verre bicolore (partie basse or) ouverture gauche / Spiegelschrank mit lackiertem Korpus und zweifarbigem Glas (unterer Teil Gold), Öffnung links / Зеркальный шкафчик с крашенным корпусом и двухцветным зеркалом (нижняя часть – oro), открывание слева</p>	50 x 31 x 145 h	SPELCLSX	61,00	<ul style="list-style-type: none"> <li>● *X = NO - Black\Gold</li> <li>● *X = OC - Cemento\Gold</li> </ul>	<p>2368,00</p> <p>2611,00</p>
 <p><b>Elio Slim</b> <b>Reversible cabinet mirror, can be hung on either the left or right side, with lacquered shell</b> Espejo contenedor reversible dcha./izda.. con capa lacada / Miroir armoire de toilette reversible dx/sx structure laquée / Spiegelschrank reversibel re./li., Korpus lackiert / Зеркальный шкафчик реверсивный dx/sx с крашенным корпусом</p>	50 x 15 x 145 h	SPELSCL	40,00	<ul style="list-style-type: none"> <li>● *X = NM - Matt Black</li> <li>● *X = CM - Cemento</li> </ul>	<p>2016,00</p> <p>2195,00</p>
 <p><b>Elio Slim</b> <b>Cabinet mirror with lacquered shell and bicolour glass (bottom mirror gold) right side opening</b> Espejo contenedor con capa lacada y cristal bicolor (parte baja oro), apertura derecha / Miroir armoire de toilette structure laquée et verre bicolore (partie basse or) ouverture droite / Spiegelschrank mit lackiertem Korpus und zweifarbigem Glas (unterer Teil Gold), Öffnung rechts / Зеркальный шкафчик с крашенным корпусом и двухцветным зеркалом (нижняя часть – oro), открывание справа</p>	50 x 15 x 145 h	SPELSCLDX	40,00	<ul style="list-style-type: none"> <li>● *X = NO - Black \ Gold</li> <li>● *X = OC - Cemento\Gold</li> </ul>	<p>2132,00</p> <p>2305,00</p>
 <p><b>Elio Slim</b> <b>Cabinet mirror with lacquered shell and bicolour glass (bottom mirror gold) left side opening</b> Espejo contenedor con capa lacada y cristal bicolor (parte baja oro), apertura izquierda / Miroir armoire de toilette structure laquée et verre bicolore (partie basse or) ouverture gauche / Spiegelschrank mit lackiertem Korpus und zweifarbigem Glas (unterer Teil Gold), Öffnung links / Зеркальный шкафчик с крашенным корпусом и двухцветным зеркалом (нижняя часть – oro), открывание слева</p>	50 x 15 x 145 h	SPELSCLSX	40,00	<ul style="list-style-type: none"> <li>● *X = NO - Black \ Gold</li> <li>● *X = OC - Cemento\Gold</li> </ul>	<p>2132,00</p> <p>2305,00</p>

# Arcadia - Simple Box, Simple Tall Box, Eos & Eos C

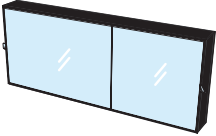
mirrors / miroirs / Spiegel / зеркала

# cielo

	Size (cm)	Product code	Net weight (Kg)	Finishes	Euro
	Medidas Dimensions Maße Размеры	Artículo Article Artikel Артикул	Peso neto Poids net Reingewicht вес нетто	Acabados Finitions Farbe Отделки	
 <p><b>Simple Box</b> Horizontal mirror cabinet with lacquered shell Espejo horizontal contenedor con capa lacada / Miroir horizontal, armoire de toilette structure laquée / Horizontaler Spiegelschrank mit lackiertem Korpus / Зеркальный шкафчик горизонтальный с крашенным корпусом</p>	90 x 12 x 45 h	SPSB(x)*	18,50	<ul style="list-style-type: none"> <li><span style="display: inline-block; width: 10px; height: 10px; background-color: black; border-radius: 50%; margin-right: 5px;"></span> *X = NM - Matt Black</li> <li><span style="display: inline-block; width: 10px; height: 10px; background-color: gray; border-radius: 50%; margin-right: 5px;"></span> *X = CM - Cemento</li> <li><span style="display: inline-block; width: 10px; height: 10px; background-color: #8B4513; border-radius: 50%; margin-right: 5px;"></span> *X = BZ - Brushed Bronze</li> <li><span style="display: inline-block; width: 10px; height: 10px; background-color: #008080; border-radius: 50%; margin-right: 5px;"></span> *X = Le Acque di Cielo</li> </ul>	<p>1088,00</p> <p>1252,00</p> <p>1416,00</p> <p>1898,00</p>
 <p><b>Simple Tall Box</b> Vertical mirror cabinet with lacquered shell, reversible Espejo vertical contenedor con capa lacada, reversible / Miroir vertical, armoire de toilette structure laquée, reversible / Vertikaler Spiegelschrank mit lackiertem Korpus - reversibel / Зеркальный шкафчик вертикальный с крашенным корпусом - реверсивный</p>	45 x 12 x 110 h	SPSTB(x)*	22,00	<ul style="list-style-type: none"> <li><span style="display: inline-block; width: 10px; height: 10px; background-color: black; border-radius: 50%; margin-right: 5px;"></span> *X = NM - Matt Black</li> <li><span style="display: inline-block; width: 10px; height: 10px; background-color: gray; border-radius: 50%; margin-right: 5px;"></span> *X = CM - Cemento</li> <li><span style="display: inline-block; width: 10px; height: 10px; background-color: #8B4513; border-radius: 50%; margin-right: 5px;"></span> *X = BZ - Brushed Bronze</li> <li><span style="display: inline-block; width: 10px; height: 10px; background-color: #008080; border-radius: 50%; margin-right: 5px;"></span> *X = Le Acque di Cielo</li> </ul>	<p>976,00</p> <p>1122,00</p> <p>1266,00</p> <p>1771,00</p>
 <p><b>Eos</b> Oval mirror with LED light (without switch) Espejo ovalado con luz led (sin interruptor) / Miroir oval éclairage à led (sans interrupteur) / Ovaler Spiegel mit LED-Beleuchtung (ohne Schalter) / Зеркало овальное со светодиодной подсветкой (без Выключатель)</p>	67 x 4 x 107 h	SPEOL	17,50		1081,00
 <p><b>Eos</b> Two coloured oval mirror (with bottom mirror in Oro or Muschio) with LED light (without switch) Espejo ovalado bicolor (con porción baja color Muschio o Oro) con luz led (sin interruptor) / Miroir oval bicolore (partie basse couleur Muschio ou OR) avec éclairage à led (sans interrupteur) / Ovaler zweifarbiges Spiegel (unterer Teil Farbe Moos oder Gold), mit LED-Beleuchtung (ohne Schalter) / Зеркало овальное двухцветное (нижняя часть Muschio или Oro) со светодиодной подсветкой (без Выключатель)</p>	67 x 4 x 107 h	SPEOBL	17,50	<p>bottom mirror</p> <ul style="list-style-type: none"> <li><span style="display: inline-block; width: 10px; height: 10px; background-color: #008080; border-radius: 50%; margin-right: 5px;"></span> *X = MU - Muschio</li> <li><span style="display: inline-block; width: 10px; height: 10px; background-color: #FFD700; border-radius: 50%; margin-right: 5px;"></span> *X = OR - Gold</li> </ul>	<p>1054,00</p> <p>1098,00</p>
 <p><b>Eos-c</b> Mirror with glass shelf, with LED light on shelf (without switch) Espejo con estante en cristal, con luz led integrada (sin interruptor) / Miroir avec étagère en verre, éclairage intégré à LED (sans interrupteur) / Spiegel mit Glaskonsole, mit eingebauter LED-Beleuchtung (ohne Schalter) / Зеркало со стеклянной полочкой и встроенной светодиодной подсветкой (без Выключатель)</p>	67 x 12 x 107 h	SPEOML	23,00	<ul style="list-style-type: none"> <li><span style="display: inline-block; width: 10px; height: 10px; background-color: black; border-radius: 50%; margin-right: 5px;"></span> *X = NM - Matt Black</li> <li><span style="display: inline-block; width: 10px; height: 10px; background-color: gray; border-radius: 50%; margin-right: 5px;"></span> *X = CM - Cemento</li> </ul>	<p>1483,00</p> <p>1483,00</p>

Le Acque di Cielo ● OL - Oltremare ● SM - Smeraldo ● AL - Alga ● CO - Corallo ● NI - Ninfea ● AM - Anemone



# Arcadia - Pan

mirrors | miroirs | Spiegel | зеркала

# cielo

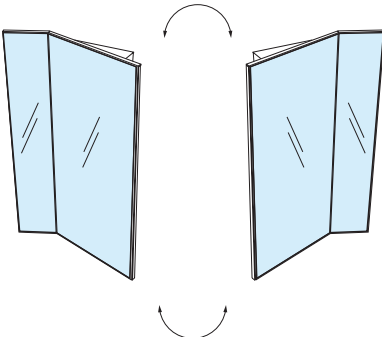
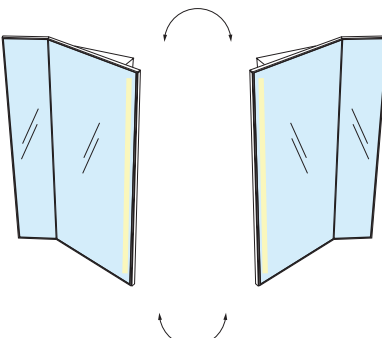
	Size (cm) Medidas Dimensions Maße Размеры	Product code Artículo Article Artikel Артикул	Net weight (Kg) Peso neto Poids net Reingewicht вес нетто	Finishes Acabados Finitions Farbe Отделки	Euro
 <p><b>Pan</b> <b>Reversible mirror, without LED light</b> Espejo reversible, sin luz led - Miroir réversible, sans éclairage led Spiegel reversibel, ohne LED-Beleuchtung Зеркало без светодиодной подсветки, установка как левосторонняя, так и правосторонняя</p>	71,5 x 17,5 x 110 h	SPPAN	15,00	<ul style="list-style-type: none"> <li>● *X = NM - Matt Black</li> <li>● *X = IL - Gloss steel</li> </ul>	<p>1211,00</p> <p>1893,00</p>
 <p><b>Pan</b> <b>Reversible mirror, with LED light</b> Espejo reversible, con luz led - Miroir réversible, avec éclairage led Spiegel reversibel, mit LED-Beleuchtung Зеркало со светодиодной подсветки, установка как левосторонняя, так и правосторонняя</p>	71,5 x 17,5 x 110 h	SPPANL	15,00	<ul style="list-style-type: none"> <li>● *X = NM - Matt Black</li> <li>● *X = IL - Gloss steel</li> </ul>	<p>1811,00</p> <p>2402,00</p>

# Arcadia - Pan

mirrors / miroirs / Spiegel / зеркала

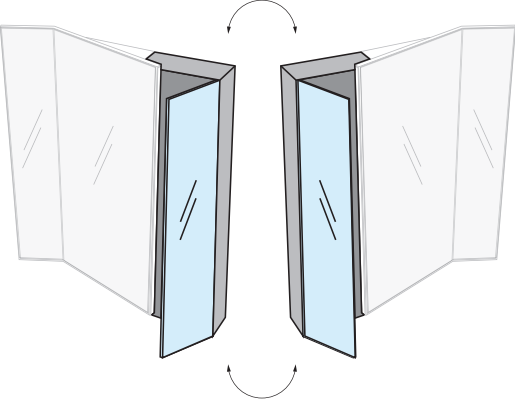
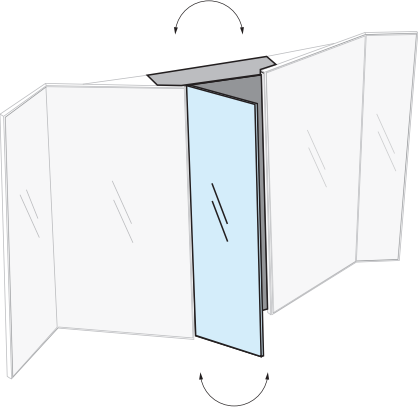

# cielo

	Size (cm) Medidas Dimensions Maße Размеры	Product code Artículo Article Artikel Артикул	Net weight (Kg) Peso neto Poids net Reingewicht вес нетто	Finishes Acabados Finitions Farbe Отделки	Euro
 <p><b>Pan</b> <b>Reversible side container element</b> Contenedor lateral reversible Élément de rangement latéral, réversible Seitliches Schrankelement, reversibel Боковой элемент – пенал, установка как левосторонняя, так и правосторонняя</p>	37 x 18 x 110 h	SPPANCL	19,00	<ul style="list-style-type: none"> <li>● *X = NM - Matt Black</li> <li>● *X = IL - Gloss steel</li> </ul>	<p>1459,00</p> <p>1701,00</p>
 <p><b>Pan</b> <b>Reversible centre container element</b> Contenedor central reversible Élément de rangement central, réversible Zentrales Schrankelement, reversibel Центральный элемент – пенал, установка как левосторонняя, так и правосторонняя</p>	30 x 18 x 110 h	SPPANCC	23,00	<ul style="list-style-type: none"> <li>● *X = NM - Matt Black</li> <li>● *X = IL - Gloss steel</li> </ul>	<p>1714,00</p> <p>1968,00</p>

# Arcadia - Argo

mirrors | miroirs | Spiegel | зеркала

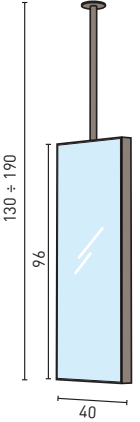
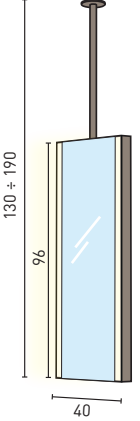
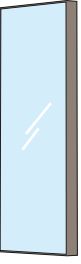
# cielo

	Size (cm)	Product code	Net weight(Kg)	Finishes	Euro	Pz.	Pz.
	Medidas Dimensions Maße Размеры	Artículo Article Artikel Артикул	Peso neto Poids net Reingewicht вес нетто	Acabados Finitions Farbe Отделки	Евро	шт. pallet Italia	шт. pallet Cont.
 <p><b>Extendable Argo mirror without led lighting (adjustable pole 5 in 5 cm)</b>                      Espejo Argo telescópico sin luz led (varilla regulable de 5 en 5 cm).                      Miroir Argo télescopique sans éclairage (bras réglable de 5 en 5 cm).                      Teleskopspiegel Argo ohne LED-Beleuchtung (Stange um jeweils 5 cm verstellbar).                      Телескопическое зеркало Argo без подсветки (регулируемая штанга 5 x 5 см).</p>	min 40 x 130 max 40 x 190	ARSP(X)*	11,00	<ul style="list-style-type: none"> <li><span style="display: inline-block; width: 10px; height: 10px; background-color: black; border-radius: 50%; margin-right: 5px;"></span> *X = FE - Matt Black</li> <li><span style="display: inline-block; width: 10px; height: 10px; background-color: #c07040; border-radius: 50%; margin-right: 5px;"></span> *X = BZ - Brushed Bronze</li> <li><span style="display: inline-block; width: 10px; height: 10px; background-color: #444; border-radius: 50%; margin-right: 5px;"></span> *X = CM - Cemento</li> <li><span style="display: inline-block; width: 10px; height: 10px; background-color: #ccc; border-radius: 50%; margin-right: 5px;"></span> *X = TL - Talco</li> </ul>	723,00 806,00 833,00 806,00		
 <p><b>Extendable Argo Mirror with led lighting (adjustable pole 5 in 5 cm), with switch</b>                      Espejo Argo telescópico con luz led (varilla regulable de 5 en 5 cm), con interruptor                      Miroir Argo télescopique avec éclairage à led (bras réglable de 5 en 5 cm), muni d'interrupteur                      Teleskopspiegel Argo mit LED-Beleuchtung (Stange um jeweils 5 cm verstellbar), mit schalter.                      Телескопическое зеркало Argo с подсветкой (регулируемая штанга 5 x 5 см) с выключателем</p>	min 40 x 130 max 40 x 190	ARSPL(X)*	11,10	<ul style="list-style-type: none"> <li><span style="display: inline-block; width: 10px; height: 10px; background-color: black; border-radius: 50%; margin-right: 5px;"></span> *X = FE - Matt Black</li> <li><span style="display: inline-block; width: 10px; height: 10px; background-color: #c07040; border-radius: 50%; margin-right: 5px;"></span> *X = BZ - Brushed Bronze</li> <li><span style="display: inline-block; width: 10px; height: 10px; background-color: #444; border-radius: 50%; margin-right: 5px;"></span> *X = CM - Cemento</li> <li><span style="display: inline-block; width: 10px; height: 10px; background-color: #ccc; border-radius: 50%; margin-right: 5px;"></span> *X = TL - Talco</li> </ul>	1032,00 1073,00 1169,00 1073,00		
 <p><b>Argo mirror without shaft, without led light</b>                      Espejo Argo senza sin barra, sin luz led                      Miroir Argo sans hampe, sans lampe LED                      Spiegel Argo ohne Stange, ohne LED-Licht                      Зеркало Argo без проведения аукциона, без подсветки ЛЕД</p>	40 x 5 x 95 h	ARSPSA(X)*	9,50	<ul style="list-style-type: none"> <li><span style="display: inline-block; width: 10px; height: 10px; background-color: black; border-radius: 50%; margin-right: 5px;"></span> *X = FE - Matt Black</li> <li><span style="display: inline-block; width: 10px; height: 10px; background-color: #c07040; border-radius: 50%; margin-right: 5px;"></span> *X = BZ - Brushed Bronze</li> <li><span style="display: inline-block; width: 10px; height: 10px; background-color: #444; border-radius: 50%; margin-right: 5px;"></span> *X = CM - Cemento</li> <li><span style="display: inline-block; width: 10px; height: 10px; background-color: #ccc; border-radius: 50%; margin-right: 5px;"></span> *X = TL - Talco</li> </ul>	605,00 707,00 740,00 707,00		
 <p><b>Argo mirror without shaft, with led light, with switch</b>                      Espejo Argo sin barra, con luz led, con interruptor                      Miroir Argo sans hampe, avec lampe LED, avec interrupteur                      Spiegel Argo ohne Stange, mit LED-Licht, mit Schalter                      Зеркало Argo без проведения аукциона, с подсветки ЛЕД, с выключатель</p>	40 x 5 x 95 h	ARSPSAL(X)*	9,60	<ul style="list-style-type: none"> <li><span style="display: inline-block; width: 10px; height: 10px; background-color: black; border-radius: 50%; margin-right: 5px;"></span> *X = FE - Matt Black</li> <li><span style="display: inline-block; width: 10px; height: 10px; background-color: #c07040; border-radius: 50%; margin-right: 5px;"></span> *X = BZ - Brushed Bronze</li> <li><span style="display: inline-block; width: 10px; height: 10px; background-color: #444; border-radius: 50%; margin-right: 5px;"></span> *X = CM - Cemento</li> <li><span style="display: inline-block; width: 10px; height: 10px; background-color: #ccc; border-radius: 50%; margin-right: 5px;"></span> *X = TL - Talco</li> </ul>	856,00 972,00 1032,00 972,00		

## Technical symbols legend

Símbolos técnicos clave | Légende symboles techniques | Technische Zeichenerklärung | Перечень технических символов

 wall-hung installation  
 instalación en la pared  
 installation murale  
 Wandmontage  
 настенная установка

 ceiling installation  
 instalación en el techo  
 installation au plafond  
 Deckenmontage  
 потолочная установка

# Arcadia - Polifemo & Pluto

mirrors | miroirs | Spiegel | зеркала

# cielo

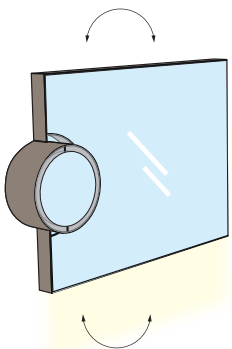
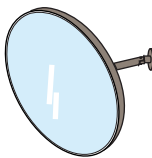
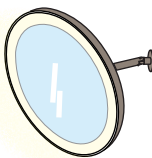
	Size (cm)	Product code	Net weight (Kg)	Finishes	Euro	Pz.	Pz.
	Medidas Dimensions Maße Размеры	Artículo Article Artikel Артикул	Peso neto Poids net Reingewicht вес нетто	Acabados Finitions Farbe Отделки	Евро	шт. pallet Italia	шт. pallet Cont.
 <p><b>Polifemo mirror with led light with switch</b> Espejo Polifemo con luz led, con interruptor Miroir Polifemo avec lampe LED, avec interrupteur Spiegel Polifemo mit LED-Licht, mit Schalter Зеркало Polifemo с подсветкой ЛЕД, С Выключатель</p>	90 x 7 x 60 h	POSPL(x)*	12,00	<ul style="list-style-type: none"> <li><span style="display: inline-block; width: 10px; height: 10px; background-color: black; border-radius: 50%; margin-right: 5px;"></span> *X = FE - Matt Black</li> <li><span style="display: inline-block; width: 10px; height: 10px; background-color: #8B4513; border-radius: 50%; margin-right: 5px;"></span> *X = BZ - Brushed Bronze</li> <li><span style="display: inline-block; width: 10px; height: 10px; background-color: #444; border-radius: 50%; margin-right: 5px;"></span> *X = CM - Cemento</li> <li><span style="display: inline-block; width: 10px; height: 10px; background-color: #CCC; border-radius: 50%; margin-right: 5px;"></span> *X = TL - Talco</li> </ul>	969,00 1041,00 1218,00 1041,00		
 <p><b>Pluto mirror without led light</b> Espejo Pluto sin luz led Miroir Pluto sans lampe LED Spiegel Pluto ohne LED-Licht Зеркало Pluto без подсветки ЛЕД</p>	Ø40	PLSP(x)*	3,50	<ul style="list-style-type: none"> <li><span style="display: inline-block; width: 10px; height: 10px; background-color: black; border-radius: 50%; margin-right: 5px;"></span> *X = FE - Matt Black</li> <li><span style="display: inline-block; width: 10px; height: 10px; background-color: #8B4513; border-radius: 50%; margin-right: 5px;"></span> *X = BZ - Brushed Bronze</li> <li><span style="display: inline-block; width: 10px; height: 10px; background-color: #444; border-radius: 50%; margin-right: 5px;"></span> *X = CM - Cemento</li> <li><span style="display: inline-block; width: 10px; height: 10px; background-color: #CCC; border-radius: 50%; margin-right: 5px;"></span> *X = TL - Talco</li> </ul>	578,00 586,00 586,00 586,00		
 <p><b>Pluto mirror with led light, with switch</b> Espejo Pluto con luz led, con interruptor Miroir Pluto avec lampe LED, avec interrupteur Spiegel Pluto mit LED-Licht, mit Schalter Зеркало Pluto с подсветкой ЛЕД, С Выключатель</p>	Ø40	PLSPL(x)*	3,60	<ul style="list-style-type: none"> <li><span style="display: inline-block; width: 10px; height: 10px; background-color: black; border-radius: 50%; margin-right: 5px;"></span> *X = FE - Matt Black</li> <li><span style="display: inline-block; width: 10px; height: 10px; background-color: #8B4513; border-radius: 50%; margin-right: 5px;"></span> *X = BZ - Brushed Bronze</li> <li><span style="display: inline-block; width: 10px; height: 10px; background-color: #444; border-radius: 50%; margin-right: 5px;"></span> *X = CM - Cemento</li> <li><span style="display: inline-block; width: 10px; height: 10px; background-color: #CCC; border-radius: 50%; margin-right: 5px;"></span> *X = TL - Talco</li> </ul>	693,00 785,00 785,00 785,00		

## Technical symbols legend

Símbolos técnicos clave | Légende symboles techniques | Technische Zeichenerklärung | Перечень технических символов

 wall-hung installation  
instalación en la pared  
installation murale  
Wandmontage  
настенная установка

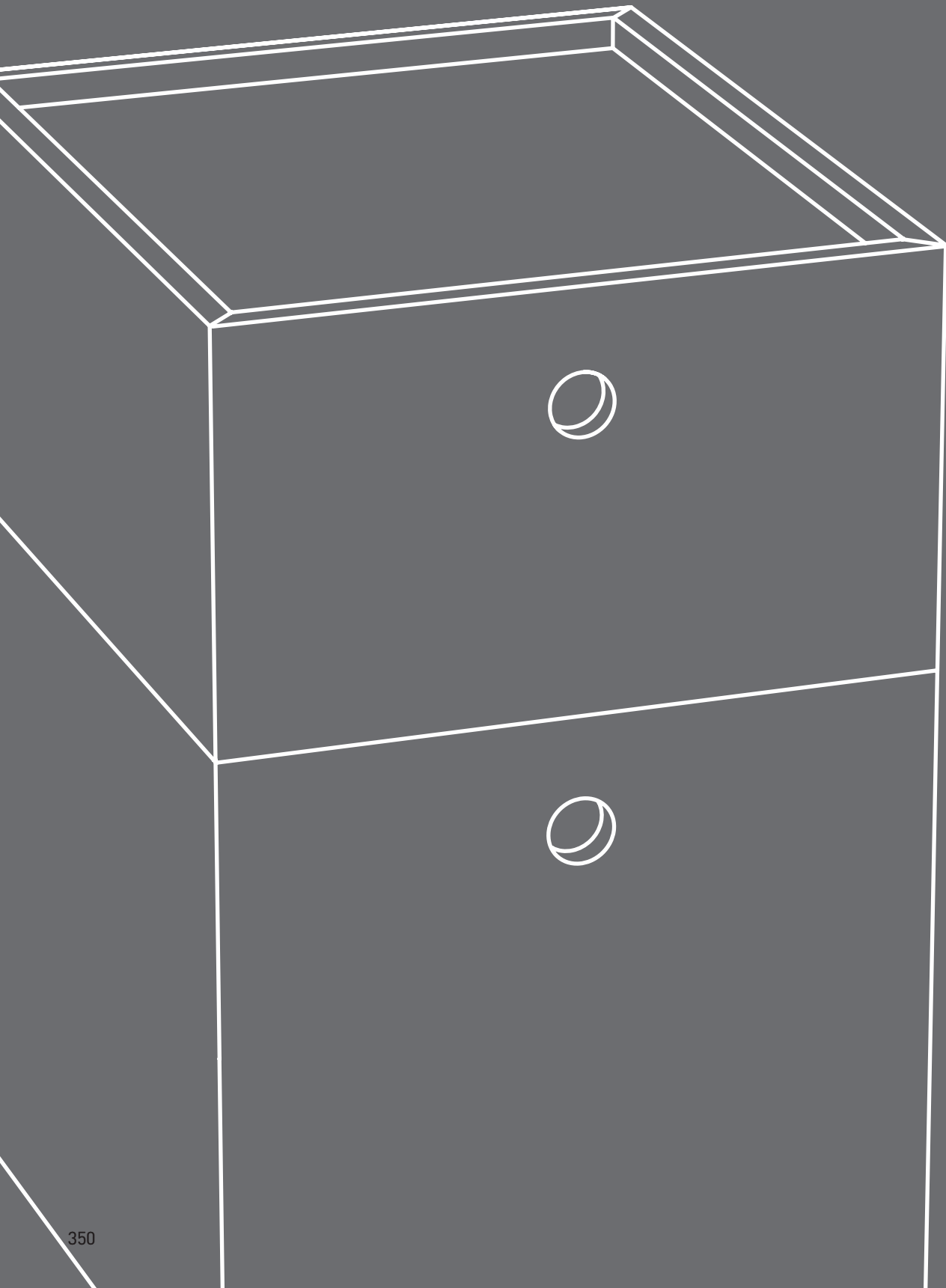

# Luisa

design Andrea Parisio & Giuseppe Pezzano

QR code configuratore \ configurator pg. 354

abaco collezione \ collection pg. 355

listino prezzi \ price list pg. 356







**Configure the product directly online and send the order to Cielo.**

Configure el producto directamente online y envíe el pedido a Cielo.  
 Configurez le produit directement en ligne et envoyez la commande à Cielo.  
 Konfigurieren Sie Ihr Produkt online und schicken Sie die Bestellung direkt an Cielo.  
 Сконфигурируйте изделие в онлайн и перешлите заказ на фабрику Cielo.

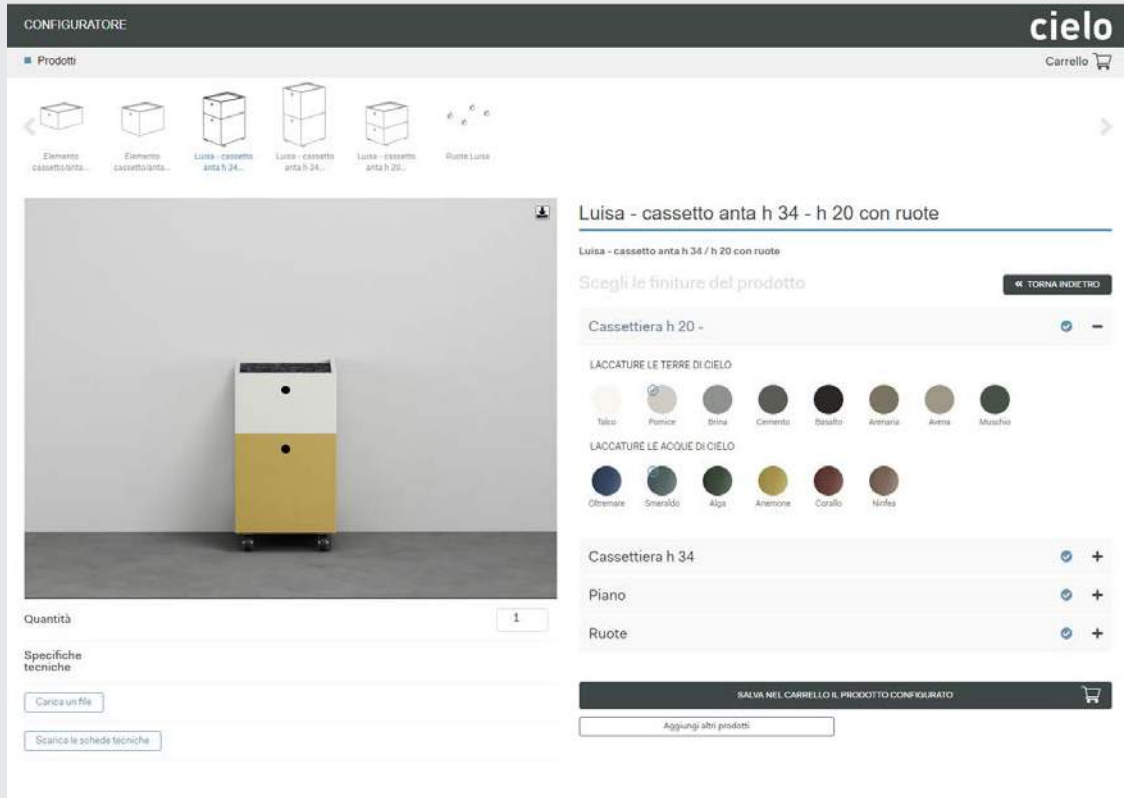

EN

SP

FR

RU



go to the configurator

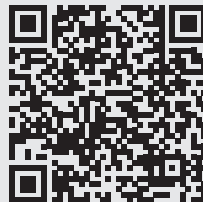

ir al configurador



lien vers le configurateur



Перейдите в configurator



## Cabinets \_Mueble\_ Meubles\_Möbel\_Консоли

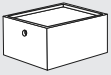

**LUCL20**  
34 x 40 x h20  
pag. 356

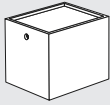

**LUCL35**  
34 x 40 x h34  
pag. 356

### Example of compositions

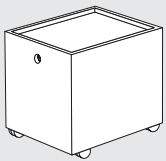

+

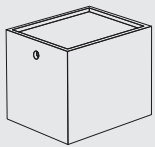

+

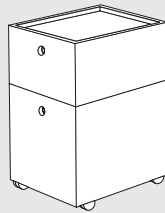

+

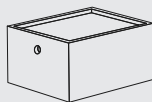

+

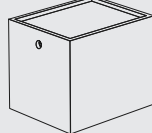

+

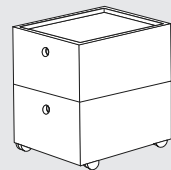
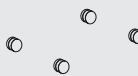

+

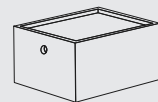

+

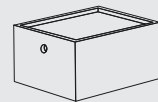

+



### Finishes cabinet

Acabado revestimiento / Finitions Revêtement / Ausführung Verkleidung / Отделка для

#### Le Terre di Cielo

- TL - Talco
- PM - Pomice
- BR - Brina
- CM - Cemento
- BA - Basalto
- AN - Arenaria
- AV - Avena
- MU - Muschio

#### Le Acque di Cielo

- OL - Oltremare
- SM - Smeraldo
- AL - Alga
- CO - Corallo
- NI - Ninfea
- AM - Anemone

### Available finish for top

Acabado encimera / Finitions plaquette / Ausführung Platte / Отделка пластин

- AZ - Azul Noche

#### Le Acque di Cielo

- OL - Oltremare
- SM - Smeraldo
- AL - Alga
- CO - Corallo
- NI - Ninfea
- AM - Anemone
- CM - Cemento



**Marble / back-painted glass countertop**

Encimera top en marmol / vidrio lacado trasero  
Plan en marbre / verre rétro-peint  
Platte aus Marmor / rückseitig lackiertem Glas  
Столешница из мрамора / стекла, крашенного с внутренней стороны

+

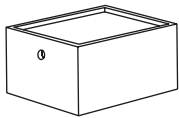

**Drawer h20**

Cajón h20  
Tiroir h20  
Schubfach h20  
Элемент ящик h20

+

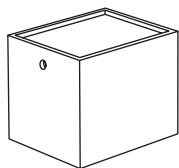

**Drawer h34**

Cajón h34  
Tiroir h34  
Schubfach h34  
Элемент ящик h34

+



**Drawer wheels**

ruedas de cajón \ roues de tiroir \ Schubladenräder \  
выдвижные колеса

Size (cm) Medidas Dimensions Maße Размеры	Product code Artículo Article Artikel Артикул	Net weight (Kg) Peso neto Poids net Reingewicht вес нетто	Finishes Acabados Finitions Farbe Отделка	Euro Евро
30 x 36 x 1 h	LUPIM(X)*	2,50	<b>STONE TOP</b> ENCIMERA EN PIEDRA / PLATEAU EN PIERRE / PLATTE AUS STEIN / Полочка из гранита  ● <b>AZ - Azul Noche</b>	<b>264,00</b>
	LUPIV(X)*	3,00	<b>BACK-PAINTED GLASS</b> VIDRIO LACADO / VERRE RETRO / rückseitig lackiertem Glas / стекла, крашенного с внутренней стороны  ● <b>Le Acque di Cielo</b>  ● *X = CM - Cemento	<b>356,00</b>  <b>293,00</b>
34 x 40 x 20 h	LUCL20(X)*	10,00	● <b>Le Terre di Cielo*</b>	<b>877,00</b>
			● <b>Le Acque di Cielo</b>	<b>1385,00</b>
34 x 40 x 34 h	LUCL35(X)*	13,50	● <b>Le Terre di Cielo*</b>	<b>1004,00</b>
			● <b>Le Acque di Cielo</b>	<b>1545,00</b>
	LUCR	2,00		<b>104,00</b>

\* Terre di Cielo laquering available for drawer / lacados Terre di Cielo disponibles para cajones | laquages Terre di Cielo disponibles pour le tiroir | Für die Schublade erhältliche Lackierungen Terre di Cielo | крашенная отделка Terre di Cielo доступна для ящика

- TL - Talco
- PM - Pomice
- BR - Brina
- AN - Arenaria
- BA - Basalto
- MU - Muschio
- AV - Avena
- CM - Cemento

\* Acque di Cielo laquering available for drawer / lacados Acque di Cielo disponibles para cajones | laquages Acque di Cielo disponibles pour le tiroir | Für die Schublade erhältliche Lackierungen Acque di Cielo | крашенная отделка Acque di Cielo доступна для ящика

- OL - Oltremare
- SM - Smeraldo
- AL - Alga
- CO - Corallo
- NI - Ninfea
- AM - Anemone





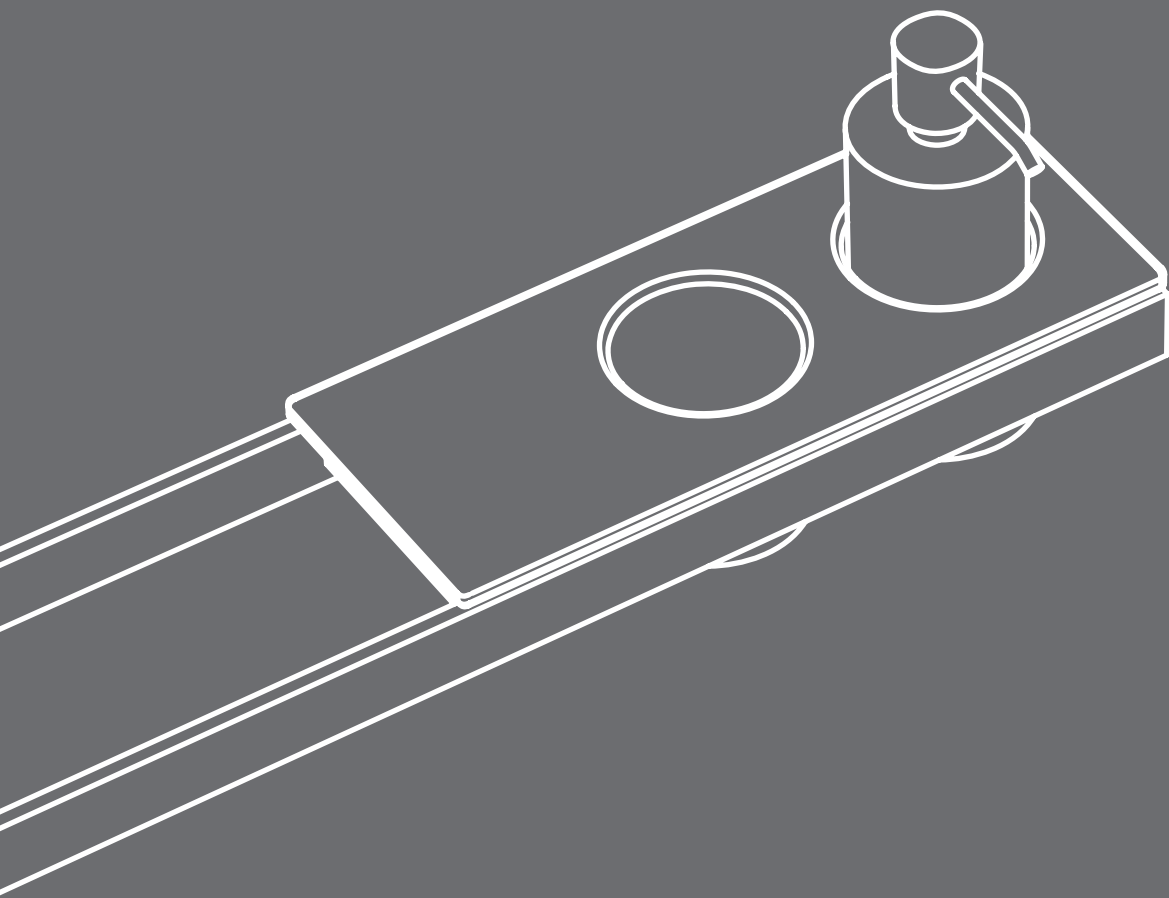

# Accessori

design Andrea Parisio & Giuseppe Pezzano

indice collezione \ collection pg. 360 - 361

listino prezzi \ price list pg. 362 - 370

**Ring towel holder**

Toallero de anillo \ Anneau porte-serviette \ Handtuchring \ Держатель для полотенец кольцо



**ACPA**  
Ø 32

**Towel rails, rectangular version**

Toallero versión rectangular / Porte-serviette version rectangulaire Handtuchhalter in rechteckiger Ausführung / Полотенцедержатель, прямоугольная версия

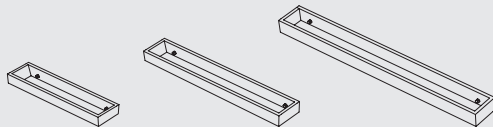

**ACPR30**  
30 x 6 x h3

**ACPR45**  
45 x 6 x h3

**ACPR60**  
60 x 6 x h3

**Towel rails, oval version**

Toallero versión oval / Porte-serviette version ovale Handtuchhalter in abgerundeter Ausführung / Полотенцедержатель, овальный версия

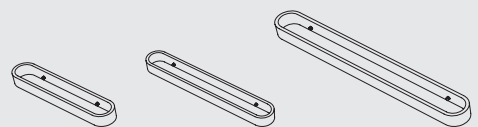

**ACPT30**  
30 x 6 x h3

**ACPT45**  
45 x 6 x h3

**ACPT60**  
60 x 6 x h3

**Tray for accessories**

Barra porta accesorios  
Barre porte-accessoires  
Rahmen für Accessoire-Halter  
Полочка-держатель для аксессуаров

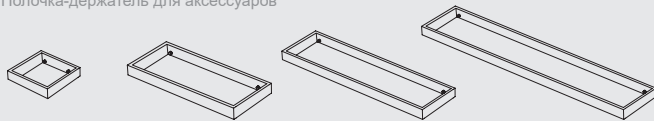

**ACB12**  
12 x 12 x h3

**ACB30**  
30 x 12 x h3

**ACB50**  
50 x 12 x h3

**ACB72**  
72 x 12 x h3

**Shelf in LivingTec**

Estante en LivingTec  
Tablette en LivingTec  
Konsole aus LivingTec  
Полочка in LivingTec

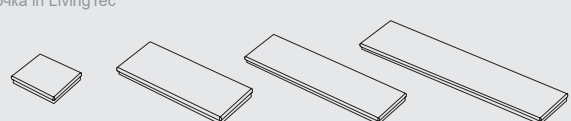

**ACM12**  
12 x 12 x h2

**ACM30**  
30 x 12 x h2

**ACM50**  
50 x 12 x h2

**ACM72**  
72 x 12 x h2

**Soap holder in LivingTec**

Jabonera en LivingTec  
Porte-savon en LivingTec  
Seifenablage aus LivingTec  
Мыльница LivingTec



**ACMP1**  
12 x 12 x h2

**ACMP2**  
30 x 12 x h2

**Soap dish with holes for a glass or dispenser in LivingTec**

Jabonera con agujero para vaso o dosificador in LivingTec  
Porte-savon avec orifice pour verre ou distributeur en LivingTec  
Seifenablage mit Öffnung für Glas oder Spender aus LivingTec  
Мыльница с отверстием для стаканчика или дозатора LivingTec



**ACMP3**  
30 x 12 x h2

**Glass or dispenser holders in LivingTec**

Porta vaso o dosificador in livingTec  
Porte-verre ou distributeur en LivingTec  
Glashalter oder Spender aus LivingTec  
Подставка под стаканчик или дозатор LivingTec

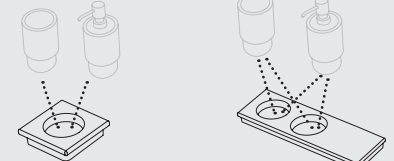

**ACMP4**  
12 x 12 x h2

**ACMP5**  
30 x 12 x h2

**Round and oval shelf**

Estante recondo-ovalado / étagère ronde-ovale / konsolerund-konsoleoval / Полочка круглая-овальная



**ACMTV**  
**ACMTM-ACST**  
Ø 12 x 3 h

**ACMOV**  
**ACMOM-ACSO**  
25 x 12 x 3 h

**Glass and dispenser in LivingTec**

Vaso y dosificador en LivingTec  
Verre et distributeur en LivingTec  
Glas und Spender aus LivingTec  
Стаканчик и дозатор LivingTec

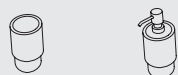

**ACBI**  
Ø7 x h11

**ACDI**  
Ø7 x h15

**Metal cup and dispenser**

Vaso-Dispensador de metal \ Verre -Distributeur en métal \ Glas-Spender aus Metall \ Стаканчик-Диспенсер из металла



**ACBIM**  
Ø7 x h11

**ACDIM**  
Ø7 x h15

**Hook**

gancho  
Crochet  
Aufhänger  
Крючок



**ACGA**  
3 x 4,5 x h3

**Hook type 1-2**

gancho tipo 1-2 \ Crochet type 1-2 \ Aufhänger Typ 1-2 \ Крючок тип 1-2

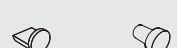

**ACGA1**  
Ø3 x 4

**ACGA2**  
Ø3 x 4

**Toilet brush holder in LivingTec**

Escobillero en LivingTec  
Porte-brosse en LivingTec  
Toiletten-Bürstengarnitur aus LivingTec  
Держатель для ершика LivingTec

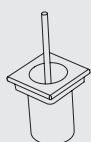

**ACPS**  
12 x 12 x h35

**Toilet brush, floor-standing and wall-hung installation**

PORTAESCOBILLERO A SUELO-SUSPENDIDO \ À POSER-PORTE-BROSSE MURAL \ TOILETTEN-BÜRSTENGARNITUR BODENSTEHEND-WANDHÄNGEND \ Ершик для унитаза напольный-настенный

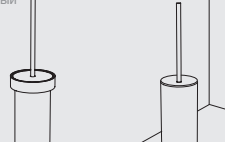

**ACPSS**  
Ø12 x h42

**ACPST**  
Ø12 x h42

**Roll holder**

Portarollos  
Porte-rouleau  
Rollenhalter  
Держатель для туалетной бумаги



**ACBR**  
14 x 12 x h3

**Roll holder**

Portarollos  
Porte-rouleau  
Rollenhalter  
Держатель для туалетной бумаги



**ACBRA**  
14 x 12 x h3

### Example of composition

Ejemplos de composiciones

Exemples de composition

Kombinationsbeispiele

Примеры композиций

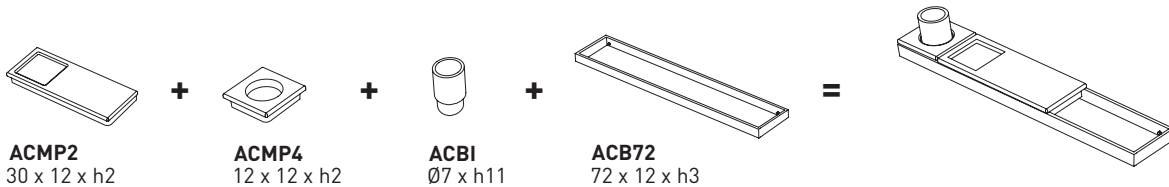
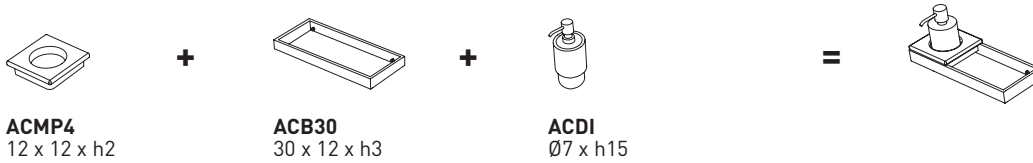

### Tray, towel rack, toilet paper holder, toilet brush holder and hook finishes

Acabado barra, toallero, portarrollos, escobillero, colgador / Finitions barres, porte-serviettes, porte-rouleau, porte-brosse, crochet Ausführung Stangen, Handtuchhalter, Rollenhalter, Toiletten-Bürstengarnitur, Aufhänger / Отделка полочек-держателей, полотенцедержателей, держателей туалетной бумаги, держателя для ершика, крючков

coatings | barnizados | vernissages | Lackierungen | Отделка металлических каркасов

- NM - Matt Black**
- CR - Chrome**
- BZ - Brushed Bronze**
- CM - Cemento**

- Matt White**

### Finishes oval towel holder, roll holder, toilet brush holder, hooks 1-2, cup and dispenser - metal

Acabados toallero ovalado, portarrollos, portaescobillas, ganchos 1-2, vaso y dispensador - metal / Finitions porte-serviettes ovale, porte-rouleau, porte-balai WC, crochets 1-2, gobelet et distributeur - métal / Beendet ovalen Handtuchhalter, Rollenhalter, Toilettenbürstenhalter, Haken 1-2, Becher und Spender - Metall / Отделка овальный держатель для полотенец, держатель для рулона, держатель для туалетной щетки, крючки 1-2, чашка и дозатор - металл

- OL - Oltremare**
- CO - Corallo**
- SM - Smeraldo**
- NI - Ninfea**
- AL - Alga**
- AM - Anemone**

The possible variations of the colour cannot be considered as defect, but as a guarantee of the completely artisan manufacturing of this unique and high quality product.

Las variaciones de colores no se consideran un defecto sino una garantía de una elaboración manual y artesanal en un producto único y de calidad.

Les éventuelles variations de couleur ne peuvent être considérées comme des défauts, elles témoignent en revanche d'une méthode de travail totalement manuelle et artisanale employée pour obtenir un produit fini unique et de qualité.

Eventuelle Farbvariationen sind nicht als Mangel anzusehen, sondern als Garantie für die komplett handwerkliche Anfertigung eines einzigartigen und hochqualitativen Produkts.

Возможные вариации цвета не могут считаться дефектом, а являются подтверждением ручной работы, гарантией качества и уникальности изделия.

**Towel rails, rectangular version**

Toallero versión rectangular  
Porte-serviette version rectangulaire  
Handtuchhalter in rechteckiger Ausführung  
Полотенцедержатель, прямоугольная версия

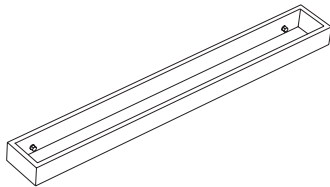
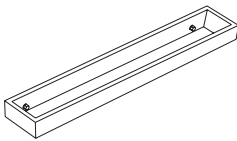
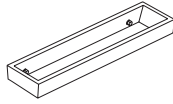

Size (cm)	Product code	Net weight (Kg)	Finishes	Euro	Pz.	Pz.			
Medidas Dimensions Maße Размеры	Artículo Article Artikel Артикул	Peso neto Poids net Reingewicht вес нетто	Acabados Finitions Farbe Отделки	Евро	шт. pallet Italia	шт. pallet Cont.			
30 x 6 x h3	ACPR30(X)*	0,81	*X = NM - Matt Black	171,00					
			*X = BZ Brushed Bronze	216,00					
			*X = CR - Chrome	216,00					
			*X = CM - Cemento	171,00					
45 x 6 x h3	ACPR45(X)*	1,21	*X = NM - Matt Black	197,00					
			*X = BZ Brushed Bronze	252,00					
			*X = CR - Chrome	252,00					
			*X = CM - Cemento	197,00					
60 x 6 x h3	ACPR60(X)*	1,62	*X = NM - Matt Black	217,00					
			*X = BZ Brushed Bronze	264,00					
			*X = CR - Chrome	264,00					
			*X = CM - Cemento	217,00					
30 x 6 x h3	ACPT30(X)*	0,81	*X = NM - Matt Black	171,00					
			*X = BZ Brushed Bronze	216,00					
			*X = CR - Chrome	216,00					
			*X = CM - Cemento	171,00					
			Le Acque di Cielo	177,00					
			45 x 6 x h3	ACPT45(X)*	1,21	*X = NM - Matt Black	197,00		
						*X = BZ Brushed Bronze	252,00		
						*X = CR - Chrome	252,00		
						*X = CM - Cemento	197,00		
						Le Acque di Cielo	216,00		
						60 x 6 x h3	ACPT60(X)*	1,62	*X = NM - Matt Black
			*X = BZ Brushed Bronze	264,00					
*X = CR - Chrome	264,00								
*X = CM - Cemento	217,00								
Le Acque di Cielo	233,00								

**Towel rails, oval version**



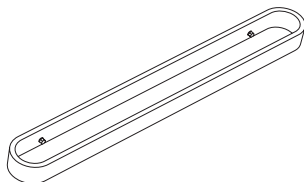
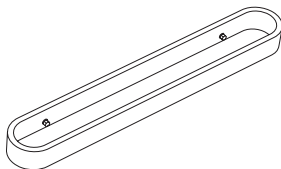
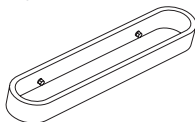

Toallero versión oval  
Porte-serviette version ovale  
Handtuchhalter in abgerundeter Ausführung  
Полотенцедержатель, овальный версия







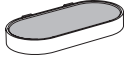
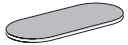













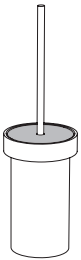





Shelves /Estante recondo / étagère /konsole /  
Полочка круглая

	Size (cm)	Product code	Net weight(Kg)	Finishes	Euro	Pz.	Pz.
	Medidas Dimensions Maße Размеры	Artículo Article Artikel Артикул	Peso neto Poids net Reingewicht вес нетто	Acabados Finitions Farbe Отделки	Евро	шт. pallet Italia	шт. pallet Cont.
<p><b>Round shelf</b> Estante recondo / étagère ronde /konsolerund / Полочка круглая</p>  <p>=</p> <p><b>Round top in back-painted glass</b> Encimera redonda en vidrio pintado por detrás \ Plateau rond en verre laqué à l'arrière \ Platte rund aus rückseitig lackiertem Glas \ стекла</p>  <p>+ </p> <p><b>Round top in Azul Noche stone</b> Encimera redonda en piedra Azul Noche \ Plateau rond en pierre Azul Noche \ Platte rund aus Azul Noche-Stein \ Полочка круглая из гранита Azul Noche</p> <p>+ </p> <p><b>Metal structure for round top</b> Estructura metálica para encimera redonda \ Structure métallique pour plateau rond \ Metallgestell für runde Platte \ Структура из металла для полочки круглой</p> 							
	Ø 11 x 1,2 h	ACMTV(x)*	0,30	<ul style="list-style-type: none"> <li>● Le Acque di Cielo</li> <li>● CM - Cemento</li> </ul>	126,00		
	Ø 11 x 1,2 h	ACMTM(x)*	0,25	<ul style="list-style-type: none"> <li>● *X = AZ Azul Noche</li> </ul>	126,00		
	Ø 12 x 3 h	ACST(x)*	0,45	<ul style="list-style-type: none"> <li>● Le Acque di Cielo</li> <li>● NM - Matt Black</li> <li>● CM - Cemento</li> </ul>	128,00		
<p><b>Oval shelf</b> Estante ovalado / étagère ovale / konsoleoval / Полочка овальная</p>  <p>=</p> <p><b>Oval top in back-painted glass</b> Encimera ovalada en vidrio pintado por detrás \ Plateau ovale en verre laqué à l'arrière \ Platte oval aus rückseitig lackiertem Glas \ Полочка овальная из окрашенного стекла</p>  <p>+ </p> <p><b>Oval top in Azul Noche stone</b> Encimera ovalada en piedra Azul Noche \ Plateau ovale en pierre Azul Noche \ Platte oval aus Azul Noche-Stein \ Полочка овальная из гранита Azul Noche</p> <p>+ </p> <p><b>Metal structure for oval top</b> Estructura metálica para encimera ovalada \ Structure métallique pour plateau ovale \ Metallgestell für ovale Platte \ Структура из металла для полочки овальной</p> 							
	23,5 x 10,5 x 1,2 h	ACMOV(x)*	0,70	<ul style="list-style-type: none"> <li>● Le Acque di Cielo</li> <li>● CM - Cemento</li> </ul>	178,00		
	23,5 x 10,5 x 1,2 h	ACMOM(x)*	0,55	<ul style="list-style-type: none"> <li>● *X = AZ Azul Noche</li> </ul>	178,00		
	25 x 12 x 3 h	ACSO(x)*	0,70	<ul style="list-style-type: none"> <li>● Le Acque di Cielo</li> <li>● NM - Matt Black</li> <li>● CM - Cemento</li> </ul>	185,00		







Le Acque di Cielo

- OL - Oltremare
- SM - Smeraldo
- AL - Alga
- CO - Corallo
- NI - Ninfea
- AM - Anemone

	Size (cm) Medidas Dimensions Maße Размеры	Product code Artículo Article Artikel Артикул	Net weight (Kg) Peso neto Poids net Reingewicht вес нетто	Finishes Acabados Finitions Farbe Отделки	Euro Евро	Pz. шт. pallet Italia	Pz. шт. pallet Cont.
 <p><b>Metal dispenser</b> Dispensador de metal \ Distributeur en métal \ Spender aus Metall \ Диспенсер из металла</p>	Ø6 x 18 h	ACDIM(x)*	0,50	<ul style="list-style-type: none"> <li> <b>Le Acque di Cielo</b> <b>229,00</b></li> <li> <b>NM - Matt Black</b> <b>204,00</b></li> <li> <b>CM - Cemento</b> <b>204,00</b></li> </ul>			
 <p><b>Metal cup</b> Vaso en metal \ Verre en métal \ Glas aus Metall \ Стаканчик из металла</p>	Ø6 x 11 h	ACBIM(x)*	0,20	<ul style="list-style-type: none"> <li> <b>Le Acque di Cielo</b> <b>86,00</b></li> <li> <b>NM - Matt Black</b> <b>78,00</b></li> <li> <b>CM - Cemento</b> <b>78,00</b></li> </ul>			
 <p><b>Hook type 1</b> gancho tipo 1 \ Crochet type 1 \ Aufhänger Typ 1 \ Крючок тип 1</p>	Ø3 x 4	ACGA1(x)*	0,15	<ul style="list-style-type: none"> <li> <b>Le Acque di Cielo</b> <b>94,00</b></li> <li> <b>NM - Matt Black</b> <b>89,00</b></li> <li> <b>CM - Cemento</b> <b>89,00</b></li> </ul>			
 <p><b>Hook type 2</b> gancho tipo 2 \ Crochet type 2 \ Aufhänger Typ 2 \ Крючок тип 2</p>	Ø3 x 4	ACGA2(x)*	0,15	<ul style="list-style-type: none"> <li> <b>Le Acque di Cielo</b> <b>94,00</b></li> <li> <b>NM - Matt Black</b> <b>89,00</b></li> <li> <b>CM - Cemento</b> <b>89,00</b></li> </ul>			
 <p><b>Ring towel holder</b> Toallero de anilla \ Anneau porte-serviette \ Handtuchring \ Держатель для полотенец кольцо</p>	Ø 32	ACPA(x)*	0,55	<ul style="list-style-type: none"> <li> <b>Le Acque di Cielo</b> <b>275,00</b></li> <li> <b>NM - Matt Black</b> <b>263,00</b></li> <li> <b>CM - Cemento</b> <b>263,00</b></li> </ul>			

	Size (cm)	Product code	Net weight(Kg)	Finishes	Euro	Pz.	Pz.
	Medidas Dimensions Maße Размеры	Artículo Article Artikel Артикул	Peso neto Poids net Reingewicht вес нетто	Acabados Finitions Farbe Отделки	Евро	шт. pallet Italia	шт. pallet Cont.
 <p><b>Metal roll holder</b> Porta rollo en metal \ Porte-rouleau en métal \ Rollenhalter aus Metall \ Держатель туалетной бумаги из металла</p>	12 x 10 x h 3	ACBRA(x)*	0,30	<ul style="list-style-type: none"> <li> <b>Le Acque di Cielo</b></li> <li> <b>NM - Matt Black</b></li> <li> <b>CM - Cemento</b></li> </ul>	202,00 192,00 192,00		
<p><b>TOILET BRUSH, WALL-HUNG INSTALLATION</b> PORTAESCOBILLERO SUSPENDIDO \ PORTE-BROSSE MURAL \ TOILETTEN-BÜRSTENGARNITUR WANDHÄNGEND \ Ершук для унитаза настенный</p>  <p><b>Metal toilet brush holder, with top in Azul Noche stone and structure for wall mounting</b> Portaescobillero en metal, con encimera en piedra Azul Noche y estructura con instalación a pared \ Porte-rouleau en métal, avec plateau en pierre Azul Noche et structure pour fixation au mur \ Toiletten-Bürstengarnitur aus Metall, mit Platte aus Azul Noche-Stein und Struktur für Wandmontage \ Ершук с полочкой из гранита Azul Noche для унитаза из металла, настенный</p> <p><b>N.B. \ P.D. \ Remarque \ HINWEIS \ Примечание</b> The code identifies the finish of the marble top, the (x) * represents the finish of the metal parts. Example: ACPSSAZ / CM indicates a toilet brush holder with an Azul Noche stone top and metal parts in a Cemento finish (/ CM). El código identifica el acabado de la encimera de mármol, la (x) * representa el acabado de las partes metálicas. Ejemplo: ACPSSAZ/CM indica un portaescobillas con base de piedra Azul Noche y partes metálicas en acabado Cemento (/ CM). Le code permet d'identifier la finition du plateau en marbre. La mention (x)* représente la finition des parties métalliques. Exemple : ACPSSAZ/CM fait référence à un porte-brosse avec un plateau en pierre Azul Noche et des parties métalliques en finition Cemento (/CM). Der Code kennzeichnet die Ausführung der Marmorplatte, das (x)* bezieht sich auf die Ausführung der Metallteile. Beispiel: ACPSSAZ/CM ist eine Toiletten-Bürstengarnitur mit Platte aus Azul Noche-Stein und Metallteilen in der Ausführung Zement (/CM). Код обозначает отделку полочки из мрамора, (x) * обозначает отделку деталей из металла. Например, ACPSSAZ / CM обозначает туалетный ершук с полочкой из гранита Azul Noche и деталями из металла в отделке Cemento (/ CM).</p>	Ø 12 x 42 h	ACPSSAZ(x)*	1,00	<p><b>STONE TOP</b> ENCIMERA EN PIEDRA / PLATEAU EN PIERRE / PLATTE AUS STEIN / Полочка из гранита</p> <ul style="list-style-type: none"> <li> <b>Azul Noche</b></li> </ul> <p style="text-align: center;">+</p> <p><b>METAL PARTS FINISHES</b> ACABADOS PARTES METÁLICAS / FINITIONS PARTIES MÉTALLIQUES / AUSFÜHRUNGEN METALLTEILE / Отделка частей из металла</p> <ul style="list-style-type: none"> <li> <b>Le Acque di Cielo</b></li> <li> <b>NM - Matt Black</b></li> <li> <b>CM - Cemento</b></li> </ul>	468,00		
 <p><b>Metal toilet brush holder, with top in back-painted glass and structure for wall mounting</b> Portaescobillero en metal, con encimera en vidrio pintado por detrás y estructura para instalación a pared \ Porte-rouleau en métal, avec plateau en verre laqué à l'arrière et structure pour fixation au mur \ Toiletten-Bürstengarnitur aus Metall, mit Platte aus rückseitig lackiertem Glas und Struktur für Wandmontage \ Ершук для унитаза из металла, с полочкой из окрашенного стекла, настенный</p> <p><b>N.B. \ P.D. \ Remarque \ HINWEIS \ Примечание</b> The code identifies the finish of the glass top, the (x) * represents the finish of the metal parts. Example: ACPSSOL/CM indicates a toilet brush holder with a glass top in an Oltremare finish (ACPSSOL) and metal parts in a Cement finish (/CM). El código identifica el acabado de la encimera de vidrio, la (x) * representa el acabado de las partes metálicas. Ejemplo: ACPSSOL / CM indica un portaescobillas con base de vidrio en acabado Oltremare (ACPSSOL) y piezas metálicas en acabado Cemento (/ CM). Le code permet d'identifier la finition du plateau en verre. La mention (x)* représente la finition des parties métalliques. Exemple : ACPSSOL/CM fait référence à un porte-brosse avec un plateau en verre en finition Oltremare (ACPSSOL) et des parties métalliques en finition Cemento (/ CM). Der Code kennzeichnet die Ausführung der Glasplatte, das (x)* bezieht sich auf die Ausführung der Metallteile. Beispiel: ACPSSOL/CM ist eine Toiletten-Bürstengarnitur mit Platte aus Glas in der Ausführung Oltremare (ACPSSOL) und Metallteilen in der Ausführung Zement (/CM). Le code permet d'identifier la finition du plateau en verre. La mention (x)* représente la finition des parties métalliques. Exemple : ACPSSOL/CM fait référence à un porte-brosse avec un plateau en verre en finition Oltremare (ACPSSOL) et des parties métalliques en finition Cemento (/ CM). Код обозначает отделку полочки из стекла, (x) * обозначает отделку деталей из металла. Например, ACPSSOL/CM обозначает туалетный ершук с полочкой из стекла в отделке Oltremare (ACPSSOL) и деталями из металла в отделке Cemento (/ CM).</p>	Ø 12 x 42 h	ACPSSOL(x)* ACPSSSM(x)* ACPSSAL(x)* ACPSSCO(x)* ACPSSNI(x)* ACPSSAM(x)* ACPSSCM(x)*	1,50 1,50 1,50 1,50 1,50 1,50 1,50	<p><b>GLASS TOP FINISHES</b> ACABADOS ENCIMERAS EN VIDRIO / FINITIONS PLATEAU EN VERRE / AUSFÜHRUNGEN GLASPLATTE / Отделка полочки из стекла</p> <ul style="list-style-type: none"> <li> <b>Oltremare</b></li> <li> <b>Smeraldo</b></li> <li> <b>Alga</b></li> <li> <b>Corallo</b></li> <li> <b>Ninfea</b></li> <li> <b>Anemone</b></li> <li> <b>Cemento</b></li> </ul> <p style="text-align: center;">+</p> <p><b>METAL PARTS FINISHES</b> ACABADOS PARTES METÁLICAS / FINITIONS PARTIES MÉTALLIQUES / AUSFÜHRUNGEN METALLTEILE / Отделка частей из металла</p> <ul style="list-style-type: none"> <li> <b>Le Acque di Cielo*</b></li> <li> <b>NM - Matt Black</b></li> <li> <b>CM - Cemento</b></li> </ul>	498,00		



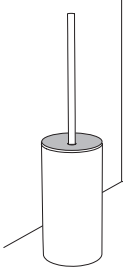

Le Acque di Cielo





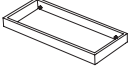

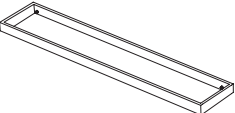
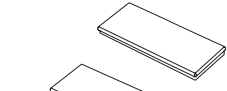
-  **OL - Oltremare**
-  **SM - Smeraldo**
-  **AL - Alga**
-  **CO - Corallo**
-  **NI - Ninfea**
-  **AM - Anemone**

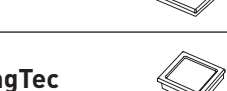
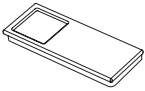
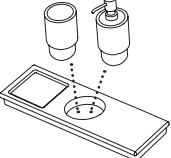
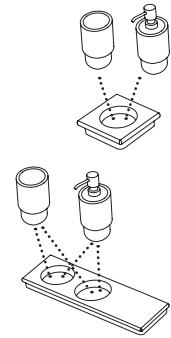
	Size (cm)	Product code	Net weight(Kg)	Finishes	Euro	Pz.	Pz.
	Medidas Dimensions Maße Размеры	Artículo Article Artikel Артикул	Peso neto Poids net Reingewicht вес нетто	Acabados Finitions Farbe Отделки	Евро	шт. pallet Italia	шт. pallet Cont.
<p><b>FLOOR-STANDING TOILET BRUSH HOLDER</b> PORTAESCOBILLERO A SUELO \ PORTE-BROSSE À POSER \ TOILETTEN-BÜRSTENGARNITUR BODENSTEHEND \ Ершик для унитаза напольный</p>  <p><b>Metal toilet brush holder with top in Azul Noche stone, floor installation</b> Portaescobillero en metal con encimera en piedra Azul Noche, instalación en tierra \ Porte-rouleau en métal avec plateau en pierre Azul Noche, installation au sol \ Toiletten-Bürstengarnitur aus Metall mit Platte aus Azul Noche-Stein, Bodeninstallation \ Ершик для унитаза из металла с полочкой из гранита Azul Noche, наземная установка</p> <p><b>N.B. \ P.D. \ Remarque \ HINWEIS \ Примечание</b> The code identifies the finish of the marble top, the (x) * represents the finish of the metal parts. Example: ACPSTAZ/CM indicates a toilet brush holder with an Azul Noche stone top and metal parts in a Cemento finish /CM). El código identifica el acabado de la encimera de mármol, la (x) * representa el acabado de las partes metálicas. Ejemplo: ACPSTAZ/CM indica un portaescobillas con base de piedra Azul Noche y partes metálicas en acabado Cemento (/CM). Le code permet d'identifier la finition du plateau en marbre. La mention (x)* représente la finition des parties métalliques. Exemple: ACPSTAZ/CM fait référence à un porte-brosse avec un plateau en pierre Azul Noche et des parties métalliques en finition Cemento (/CM). Der Code kennzeichnet die Ausführung der Marmorplatte, das (x)* bezieht sich auf die Ausführung der Metallteile. Beispiel: ACPSTAZ/CM ist eine Toiletten-Bürstengarnitur mit Platte aus Azul Noche-Stein und Metallteilen in der Ausführung Zement (/CM). Код обозначает отделку полочки из мрамора, (x) * обозначает отделку деталей из металла. Например: ACPSTAZ/CM обозначает туалетный ершик с полочкой из гранита Azul Noche и деталями из металла в отделке Cemento (/CM).</p>	<p>Ø 12 x 42 h</p>	<p>ACPSTAZ(x)*</p>	<p>0,75</p>	<p><b>STONE TOP</b> ENCIMERA EN PIEDRA / PLATEAU EN PIERRE / PLATTE AUS STEIN / Полочка из гранита</p> <ul style="list-style-type: none"> <li>● Azul Noche</li> </ul> <p>+</p> <p><b>METAL PARTS FINISHES</b> ACABADOS PARTES METÁLICAS / FINITIONS PARTIES MÉTALLIQUES / AUSFÜHRUNGEN METALLTEILE / Отделка частей из металла</p> <ul style="list-style-type: none"> <li>● Le Acque di Cielo</li> <li>● NM - Matt Black</li> <li>● CM - Cemento</li> </ul>	<p>377,00</p>		
				<p><b>Metal toilet brush holder with top in back-painted glass, floor installation</b> Portaescobillero en metal con encimera en vidrio pintado por detrás, instalación en tierra \ Porte-rouleau en métal avec plateau en verre laqué à l'arrière, installation au sol \ Toiletten-Bürstengarnitur aus Metall mit Platte aus rückseitig lackiertem Glas, Bodeninstallation \ Ершик для унитаза из металла с полочкой из окрашенного стекла, наземная установка</p> <p><b>N.B. \ P.D. \ Remarque \ HINWEIS \ Примечание</b> The code identifies the finish of the glass top, the (x) * represents the finish of the metal parts. Example: ACPSTOL/CM indicates a toilet brush holder with a glass top in an Oltremare finish (ACPSTOL) and metal parts in a Cement finish (/CM). El código identifica el acabado de la encimera de vidrio, la (x) * representa el acabado de las partes metálicas. Ejemplo: ACPSTOL/CM indica un portaescobillas con base de vidrio en acabado Oltremare (ACPSTOL) y piezas metálicas en acabado Cemento (/CM). Der Code kennzeichnet die Ausführung der Glasplatte, das (x)* bezieht sich auf die Ausführung der Metallteile. Beispiel: ACPSTOL/CM ist eine Toiletten-Bürstengarnitur mit Platte aus Glas in der Ausführung Oltremare (ACPSTOL) und Metallteilen in der Ausführung Zement (/CM). Le code permet d'identifier la finition du plateau en verre. La mention (x)* représente la finition des parties métalliques. Exemple: ACPSTOL/CM fait référence à un porte-brosse avec un plateau en verre en finition Oltremare (ACPSTOL) et des parties métalliques en finition Cemento (/CM). Код обозначает отделку полочки из стекла, (x) * обозначает отделку деталей из металла. Например: ACPSTOL/CM обозначает туалетный ершик с полочкой из стекла в отделке Oltremare (ACPSTOL) и деталями из металла в отделке Cemento (/CM).</p>			





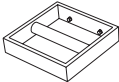

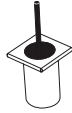

Le Acque di Cielo

- OL - Oltremare
- SM - Smeraldo
- AL - Alga
- CO - Corallo
- NI - Ninfea
- AM - Anemone

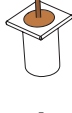
	<b>Size (cm)</b> Medidas Dimensions Maße Размеры	<b>Product code</b> Artículo Article Artikel Артикул	<b>Net weight (Kg)</b> Peso neto Poids net Reingewicht вес нетто	<b>Finishes</b> Acabados Finitions Farbe Отделки	<b>Euro</b> Евро	<b>Pz.</b> шт. pallet Italia	<b>Pz.</b> шт. pallet Cont.
<b>Tray for accessories</b> Barra porta accesorios Barre porte-accessoires Rahmen für Accessoire-Halter Полочка-держатель для аксессуаров	12 x 12 x h3	ACB12(X)*	0,55	● *X = NM - Matt Black ● *X = BZ ● Bronzo Spazzolato ● *X = CR - Cromo ● *X = CM - Cemento	134,00		
	30 x 12 x h3	ACB30(X)*	0,95	● *X = NM - Matt Black ● *X = BZ ● Bronzo Spazzolato ● *X = CR - Cromo ● *X = CM - Cemento	171,00		
	50 x 12 x h3	ACB50(X)*	1,44	● *X = NM - Matt Black ● *X = BZ ● Bronzo Spazzolato ● *X = CR - Cromo ● *X = CM - Cemento	197,00		
	72 x 12 x h3	ACB72(X)*	2,00	● *X = NM - Matt Black ● *X = BZ ● Bronzo Spazzolato ● *X = CR - Cromo ● *X = CM - Cemento	216,00		
<b>Shelf in LivingTec</b> Estante en LivingTec Tablette en LivingTec Konsole aus LivingTec Полочка in LivingTec	12 x 12 x h2	ACM12(X)*	0,50	○ Matt White	81,00		
	30 x 12 x h2	ACM30(X)*	1,20	○ Matt White	104,00		
	50 x 12 x h2	ACM50(X)*	2,00	○ Matt White	151,00		
	72 x 12 x h2	ACM72(X)*	3,20	○ Matt White	207,00		
<b>Soap holder in LivingTec</b> Jabonera en LivingTec Porte-savon en LivingTec Seifenablage aus LivingTec Мыльница LivingTec	12 x 12 x h2	ACMP1(X)*	0,40	○ Matt White	88,00		
	30 x 12 x h2	ACMP2(X)*	1,00	○ Matt White	146,00		
<b>Soap dish with holes for a glass or dispenser in LivingTec</b> Jabonera con agujero para vaso o dosificador in LivingTec Porte-savon avec orifice pour verre ou distributeur en LivingTec Seifenablage mit Öffnung für Glas oder Spender aus LivingTec Мыльница с отверстием для стаканчика или дозатора LivingTec	30 x 12 x h2	ACMP3(X)*	0,97	○ Matt White	157,00		
	12 x 12 x h2	ACMP4(X)*	0,30	○ Matt White	86,00		
<b>Glass or dispenser holders in LivingTec</b> Porta vaso o dosificador in livingTec Porte-verre ou distributeur en LivingTec Glashalter oder Spender aus LivingTec Подставка под стаканчик или дозатор LivingTec	30 x 12 x h2	ACMP5(X)*	0,85	○ Matt White	123,00		
							

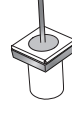
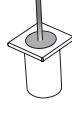
		Size (cm) Medidas Dimensions Maße Размеры	Product code Artículo Article Artikel Артикул	Net weight(Kg) Peso neto Poids net Reingewicht вес нетто	Finishes Acabados Finitions Farbe Отделки	Euro Евро	Pz. шт. pallet Italia	Pz. шт. pallet Cont.
<b>Cup in LivingTec</b> Vaso en LivingTec Verre en LivingTec Glas aus LivingTec Стаканчик LivingTec		Ø7 x h11	ACBI	0,30	○ <b>Matt White</b>	<b>73,00</b>		
<b>Dispenser in LivingTec (white glass with Black Matt dispenser)</b> Dosificador en LivingTec (dosificador Blanco con dispensador Negro Mate) Distributeur en LivingTec (Verre Blanc avec distributeur Noir Matt) Spender aus LivingTec (Glas Weiß mit Spenderpumpe Matt Schwarz) дозатор LivingTec (стаканчик белый, дозатор в отделке Nero Matt)		Ø7 x h15	ACDI	0,60	● <b>NM - Matt Black</b>	<b>213,00</b>		
<b>Dispenser in LivingTec (white glass with Brushed Bronze dispenser)</b> Dosificador en LivingTec (dosificador blanco con dispensador bronce cepillado) Distributeur en LivingTec (verre blanc avec distributeur bronze brossé) Spender aus LivingTec (Glas Weiß mit Spenderpumpe Bronze Gebürstet) дозатор LivingTec (стаканчик белый, дозатор в отделке Bronzo Spazzolato)		Ø7 x h15	ACDI	0,60	● <b>BZ - Brushed Bronze</b>	<b>228,00</b>		
<b>Dispenser in LivingTec (white glass with Chrome dispenser)</b> Dosificador en LivingTec (dosificador Blanco con dispensador cromado) Distributeur en LivingTec (verre Blanc avec distributeur Chrome) Spender aus LivingTec (Glas Weiß mit Spenderpumpe Chrom) дозатор LivingTec (стаканчик белый, дозатор в отделке Cromo)		Ø7 x h15	ACDI	0,60	● <b>CR - Chrome</b>	<b>228,00</b>		
<b>Dispenser in LivingTec (white glass with Cemento dispenser)</b> Dosificador en LivingTec (dosificador Blanco con dispensador Cemento) Distributeur en LivingTec (verre Blanc avec distributeur Cemento) Spender aus LivingTec (Glas Weiß mit Spenderpumpe Cemento) дозатор LivingTec (стаканчик белый, дозатор в отделке титан)		Ø7 x h15	ACDI	0,60	● <b>CM - Cemento</b>	<b>213,00</b>		
<b>Roll holder</b> Portarollos Porte-rouleau Rollenhalter Держатель для туалетной бумаги		14 x 12 x h3	ACBR(X)*	0,78	● *X = <b>NM - Matt Black</b> ● *X = <b>BZ - Bronzo Spazzolato</b> ● *X = <b>CR - Cromo</b> ● *X = <b>CM - Cemento</b>	<b>184,00</b> <b>255,00</b> <b>255,00</b> <b>184,00</b>		
<b>Hook</b> Colgador Crochet Aufhänger Крючок		3 x 4,5 x 3 h	ACGA(X)*	0,15	● *X = <b>NM - Matt Black</b> ● *X = <b>BZ - Brushed Bronze</b> ● *X = <b>CR - Chrome</b> ● *X = <b>CM - Cemento</b>	<b>81,00</b> <b>100,00</b> <b>100,00</b> <b>81,00</b>		

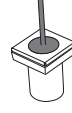
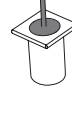

	Size (cm)	Product code	Net weight (Kg)	Finishes	Euro	Pz.	Pz.
	Medidas Dimensions Maße Размеры	Artículo Article Artikel Артикул	Peso neto Poids net Reingewicht вес нетто	Acabados Finitions Farbe Отделки	Евро	шт. pallet Italia	шт. pallet Cont.
<p><b>Toilet brush holder in LivingTec (white glass and Black Matt toilet brush)</b></p> <p>Escobillero en LivingTec (contenedor Blanco y escobillero Negro Mate) Porte-brosse en LivingTec (pot Blanc avec balayette Noire Matt) Toiletten-Bürstengarnitur aus LivingTec (Behälter Weiß mit Toilettenbürste Matt Schwarz) Держатель для ершика LivingTec (стакан-подставка белая, рукоятка в отделке Negro Matt)</p>  <p>=</p>  <p>+</p>	12 x 12 x h35	ACPS	1,60	● <b>NM - Matt Black</b>	<b>255,00</b>		
<p><b>Tray for accessories</b></p> <p>Barra porta accesorios / Barre porte-accessoires Rahmen für Accessoire-Halter / Полочка-держатель для аксессуаров</p> 	12 x 12 x h3	ACB12(X)*	0,55	● <b>NM - Matt Black</b>	<b>134,00</b>		
<p><b>Toilet brush holder in LivingTec (white glass and Brushed Bronze toilet brush)</b></p> <p>Escobillero en LivingTec (contenedor Blanco y escobillero Bronce Cepillado) Porte-brosse en LivingTec (pot Blanc avec balayette Bronze Brossé) Toiletten-Bürstengarnitur aus LivingTec (Behälter Weiß mit Toilettenbürste Bronze Gebürstet) Держатель для ершика LivingTec (стакан-подставка белая, рукоятка в отделке Bronzo Spazzolato)</p>  <p>=</p>  <p>+</p>	12 x 12 x h35	ACPS	1,60	● <b>BZ - Brushed Bronze</b>	<b>281,00</b>		
<p><b>Tray for accessories</b></p> <p>Barra porta accesorios / Barre porte-accessoires Rahmen für Accessoire-Halter / Полочка-держатель для аксессуаров</p> 	12 x 12 x h3	ACB12(X)*	0,55	● <b>BZ - Brushed Bronze</b>	<b>194,00</b>		
<p><b>Toilet brush holder in LivingTec (white glass and Chrome toilet brush)</b></p> <p>Escobillero en LivingTec (contenedor Blanco y escobillero Cromado) Porte-brosse en LivingTec (pot Blanc avec balayette Chrome) Toiletten-Bürstengarnitur aus LivingTec (Behälter Weiß mit Toilettenbürste Chrom) Держатель для ершика LivingTec (стакан-подставка белая, рукоятка в отделке Cromo)</p>  <p>=</p>  <p>+</p>	12 x 12 x h35	ACPS	1,60	● <b>CR - Chrome</b>	<b>281,00</b>		
<p><b>Tray for accessories</b></p> <p>Barra porta accesorios / Barre porte-accessoires Rahmen für Accessoire-Halter / Полочка-держатель для аксессуаров</p> 	12 x 12 x h3	ACB12(X)*	0,55	● <b>CR - Chrome</b>	<b>194,00</b>		
<p><b>Toilet brush holder in LivingTec (white glass and Cemento toilet brush)</b></p> <p>Escobillero en LivingTec (contenedor Blanco y escobillero Cemento) Porte-brosse en LivingTec (pot Blanc avec balayette Cemento) Toiletten-Bürstengarnitur aus LivingTec (Behälter Weiß mit Toilettenbürste Cemento) Держатель для ершика LivingTec (стакан-подставка белая, рукоятка в отделке титан)</p>  <p>=</p>  <p>+</p>	12 x 12 x h35	ACPS	1,60	● <b>CM - Cemento</b>	<b>255,00</b>		
<p><b>Tray for accessories</b></p> <p>Barra porta accesorios / Barre porte-accessoires Rahmen für Accessoire-Halter / Полочка-держатель для аксессуаров</p> 	12 x 12 x h3	ACB12(X)*	0,55	● <b>CM - Cemento</b>	<b>134,00</b>		





# Le Bacinelle

I Catini  
Theo  
Tino Mini  
Tino  
Tina

design **Andrea Parisio, Giuseppe Pezzano**

Eco  
Eco Small  
Era  
Era Small  
Handy

design **Luca Cimarra**

Mare

design **Matteo Thun, Antonio Rodriguez**













**CALAT45**  
ø45 x 16 h  
pag. 378



**CALA055**  
55 x 42 x 16 h  
pag. 378



**CALA065**  
65 x 44 x 16 h  
pag. 378



**THLAO**  
55 x 40 x 16 h  
pag. 378



**THLAT**  
ø40 x 16 h  
pag. 378



**BAT030**  
ø30 x 14,5 h  
pag. 378



**BATO**  
ø43 x 19 h  
pag. 378



**BATA**  
ø45 x 26 h  
pag. 378



**BAERA**  
ø45 x 24 h  
pag. 380



**BAERA40**  
ø40 x 15 h  
pag. 380



**BAECO**  
62 x 45 x 18 h  
pag. 380



**BAECO58**  
58 x 42 x 16,5 h  
pag. 380



**HALAT45**  
ø45 x 17 h  
pag. 380



**MRLAT**  
ø45 x 15 h  
pag. 380



**MRLAO**  
60 x 38 x 15 h  
pag. 380

## Finishes

Acabados  
Finitions  
Farbe  
Отделки

 Glossy White

### Le Terre di Cielo

- |  |   |
|--|---|
|  TL - Talco   |  AN - Arenaria |
|  PM - Pomice  |  AV - Avena    |
|  BR - Brina   |  MU - Muschio  |
|  CM - Cemento |  AG - Agave    |
|  BA - Basalto |  LN - Lino     |
|  LV - Lavagna |  CN - Canapa   |
|  FN - Fango   |  CP - Cipria   |
|  CA - Cacao   |  PL - Polvere  |

### Le Acque di Cielo

- |  |
|--|
|  OL - Oltremare |
|  SM - Smeraldo  |
|  AL - Alga      |
|  CO - Corallo   |
|  NI - Ninfea    |
|  AM - Anemone   |









































The possible variations of the colour cannot be considered as defect, but as a guarantee of the completely artisan manufacturing of this unique and high quality product.

Las variaciones de colores no se consideran un defecto sino una garantía de una elaboración manual y artesanal en un producto único y de calidad.

Les éventuelles variations de couleur ne peuvent être considérées comme des défauts, elles témoignent en revanche d'une méthode de travail totalement manuelle et artisanale employée pour obtenir un produit fini unique et de qualité.

























Eventuelle Farbvariationen sind nicht als Mangel anzusehen, sondern als Garantie für die komplett handwerkliche Anfertigung eines einzigartigen und hochqualitativen Produkts.

Возможные вариации цвета не могут считаться дефектом, а являются подтверждением ручной работы, гарантией качества и уникальности изделия.

	Size (cm) Medidas Dimensions Maße Размеры	Product code Artículo Article Artikel Артикул	Net weight (Kg) Peso neto Poids net Reingewicht вес нетто	Finishes Acabados Finitions Farbe Отделки	Euro Евро	Pz. шт. pallet Italia	Pz. шт. pallet Cont.
  <p><b>Round on top bowl Catino ø45</b> Cubela de apoyo Catino ronda ø45 / Vasque à poser Catino tour ø45 / Aufsatzbecken Runde Catino ø45 / Раковина круглый Catino ø45</p>	ø45 x h 6	CALAT45(X)*	9,00	<ul style="list-style-type: none"> <li> Gloss White</li> <li> Le Terre di Cielo</li> <li> Le Acque di Cielo</li> </ul>	<p>643,00</p> <p>815,00</p> <p>815,00</p>	20	30
  <p><b>Oval on top bowl Catino 55</b> Cubela de apoyo Catino Oval 55 / Vasque à poser Catino Oval 55 / Aufsatzbecken Oval Catino 55 / Раковина овальный Catino 55</p>	55 x 42 x h 16	CALA055(X)*	10,00	<ul style="list-style-type: none"> <li> Gloss White</li> <li> Le Terre di Cielo</li> <li> Le Acque di Cielo</li> </ul>	<p>688,00</p> <p>896,00</p> <p>896,00</p>	14	21
  <p><b>Oval on top bowl Catino 65</b> Cubela de apoyo Catino Oval 65 / Vasque à poser Catino Oval 65 / Aufsatzbecken Oval Catino 65 / Раковина овальный Catino 65</p>	65 x 44 x h 16	CALA065(X)*	13,00	<ul style="list-style-type: none"> <li> Gloss White</li> <li> Le Terre di Cielo</li> <li> Le Acque di Cielo</li> </ul>	<p>705,00</p> <p>919,00</p> <p>919,00</p>	12	21
  <p><b>Round Theo washbasin</b> Lavabo Theo ronda \ Lavabo Theo tour \ Aufsatzbecken Runde Theo \ Theo Раковина круглый</p>	ø40 x 16 h	THLAT(X)*	8,50	<ul style="list-style-type: none"> <li> Gloss White</li> <li> Le Terre di Cielo</li> <li> Le Acque di Cielo</li> </ul>	<p>457,00</p> <p>723,00</p> <p>723,00</p>	24	48
  <p><b>Oval Theo washbasin</b> Lavabo Theo oval \ Lavabo Theo ovale \ Aufsatzbecken Oval Theo \ Раковина овальный Theo</p>	55 x 40 x 16 h	THLAO(X)*	10,50	<ul style="list-style-type: none"> <li> Gloss White</li> <li> Le Terre di Cielo</li> <li> Le Acque di Cielo</li> </ul>	<p>688,00</p> <p>896,00</p> <p>896,00</p>	14	21
  <p><b>On top bowl Tino Mini</b> Cubela de apoyo Tino Mini \ Vasque à poser Tino Mini Aufsatzbecken Tino Mini \ Накладная чаша Tino Mini</p>	ø30 x 14,5 h	BATO30(X)*	5,00	<ul style="list-style-type: none"> <li> Gloss White</li> <li> Le Terre di Cielo</li> <li> Le Acque di Cielo</li> </ul>	<p>296,00</p> <p>423,00</p> <p>423,00</p>	42	94
  <p><b>On top bowl h19 Tino</b> Cubela de apoyo h19 Tino \ Vasque à poser h19 Tino Aufsatzbecken h19 Tino \ Накладная чаша h19 Tino</p>	ø43 x 19 h	BATO(X)*	10,30	<ul style="list-style-type: none"> <li> Gloss White</li> <li> Le Terre di Cielo</li> <li> Le Acque di Cielo</li> </ul>	<p>427,00</p> <p>697,00</p> <p>697,00</p>	26	52
  <p><b>On top bowl h26 Tina</b> Cubela de apoyo h26 Tina \ Vasque à poser h26 Tina Aufsatzbecken h26 Tina \ Накладная чаша h26 Tina</p>	ø45 x 26 h	BATA(X)*	11,90	<ul style="list-style-type: none"> <li> Gloss White</li> <li> Le Terre di Cielo</li> <li> Le Acque di Cielo</li> </ul>	<p>638,00</p> <p>832,00</p> <p>832,00</p>	16	32

# Le Bacinelle

drains and siphons / desagües y sifones / les drains et les siphons / Ablaufgarnituren und Siphons / Донные клапаны и сифоны



































	Product code Artículo Article Artikel Артикул	Net weight (Kg) Peso neto Poids net Reingewicht вес нетто	Finishes Acabados Finitions Farbe Отделки	Euro Евро
 <p><b>Universal click/clack drain in CHROME with ceramic lid</b> Válvula universal click/clack Cromado con tapa en cerámica Bonde universelle clic/clac Chromé avec clapet en céramique Universal-Ablaufgarnitur Click-Clack Chrom mit Keramikstopfen Универсальный донный клапан click/clack хром с керамической крышкой</p>	PIL01(X)*	0,40	 <b>Gloss White</b>	<b>95,00</b>
			 <b>Le Terre di Cielo</b>	<b>139,00</b>
			 <b>Le Acque di Cielo</b>	<b>139,00</b>
 <p><b>Universal click/clack drain in BLACK MATT finish with ceramic lid</b> Válvula universal click/clack Negro Matt con tapa en cerámica Bonde universelle clic/clac Noir Mat avec clapet en céramique Universal-Ablaufgarnitur Click-Clack Matt Schwarz mit Keramikstopfen Универсальный донный клапан click/clack черный матовый с керамической крышкой</p>	PIL01NM(X)*	0,40	 <b>Gloss White</b>	<b>120,00</b>
			 <b>Le Terre di Cielo</b>	<b>169,00</b>
			 <b>Le Acque di Cielo</b>	<b>169,00</b>
 <p><b>Universal click/clack drain in CEMENTO finish with ceramic lid</b> Válvula universal click/clack Cemento con tapa en cerámica Bonde universelle clic/clac Cemento avec clapet en céramique Universal-Ablaufgarnitur Click-Clack Cement mit Keramikstopfen Универсальный донный Cemento click/clack с керамической крышкой</p>	PIL01CM(X)*	0,40	 <b>Gloss White</b>	<b>120,00</b>
			 <b>Le Terre di Cielo</b>	<b>169,00</b>
			 <b>Le Acque di Cielo</b>	<b>169,00</b>
 <p><b>Universal click/clack drain in BRONZE with ceramic lid</b> Válvula universal click/clack Bronce con tapa en cerámica Bonde universelle clic/clac Bronce avec clapet en céramique Universal-Ablaufgarnitur Click-Clack Bronze mit Keramikstopfen Универсальный донный клапан click/clack бронза с керамической крышкой</p>	PIL01BR(X)*	0,40	 <b>Gloss White</b>	<b>135,00</b>
			 <b>Le Terre di Cielo</b>	<b>182,00</b>
			 <b>Le Acque di Cielo</b>	<b>182,00</b>
 <p><b>CHROMED siphon</b> Sifone Cromado \ Siphon Chromé \ Siphon Verchromt \ сифон Chrome</p>	SISP	0,93	 <b>Chrome</b>	<b>133,00</b>
 <p><b>MATT BLACK siphon</b> Sifone Negro Mate \ Siphon Noir Mat \ Siphon Schwarz Matt \ Сифон Черный матовый</p>	SIFN	0,93	 <b>Matt Black</b>	<b>194,00</b>
 <p><b>CEMENTO siphon</b> Sifone Cemento \ Siphon Cemento \ Siphon Cemento \ сифон Cemento</p>	SIFCM	0,93	 <b>Cemento</b>	<b>194,00</b>
 <p><b>BRONZE siphon</b> Sifone Bronce \ Siphon Bronce \ Siphon Bronze \ бронза сифон</p>	SIFBR	0,93	 <b>Bronze</b>	<b>220,00</b>

























## Technical symbols legend

Simbolos técnicos clave / Légende symboles techniques / Technische Zeichenerklärung / Перечень технических символов

 <b>all sides are enamelled</b> con todos los lados esmaltados avec tous les côtés émaillés alle Seiten glasiert все стороны покрыты эмалью	 <b>no tap holes</b> sin agujero para grifo sans orifice robinet ohne Hahnloch без отверстия под смеситель	 <b>without overflow</b> sin rebosadero sans trop-plein ohne Überlauf без слива-перелива	 <b>on top installation</b> instalación de apoyo installation à partir du plan Montage auf Platte установка на столешницу
---	---	---	--

Le Terre di Cielo	 TL - Talco	 PM - Pomice	 BR - Brina	 BA - Basalto	 LV - Lavagna	 CM - Cemento	 FN - Fango	 CA - Cacao
	 AN - Arenaria	 AV - Avena	 LN - Lino	 AG - Agave	 MU - Muschio	 PL - Polvere	 CP - Cipria	 CN - Canapa
Le Acque di Cielo	 OL - Oltremare	 SM - Smeraldo	 AL - Alga	 CO - Corallo	 NI - Ninfea	 AM - Anemone		

	Size (cm)	Product code	Net weight(Kg)	Finishes	Euro	Pz.	Pz.
	Medidas Dimensions Maße Размеры	Artículo Article Artikel Артикул	Peso neto Poids net Reingewicht вес нетто	Acabados Finitions Farbe Отделки	Евро	шт. pallet Italia	шт. pallet Cont.
  <p><b>Round on top bowl Era ø45</b> Cubela de apoio Era ronda ø45 / Vasque à poser Era tour ø45 / Aufsatzbecken Runde Era ø45 / Раковина круглый Era ø45</p>	ø45 x 24 h	BAERA(X)*	13,00	<ul style="list-style-type: none"> <li> <b>Gloss White</b></li> <li> <b>Le Terre di Cielo</b></li> <li> <b>Le Acque di Cielo</b></li> </ul>	<b>667,00</b> <b>934,00</b> <b>934,00</b>	16	32
  <p><b>Era Small on top bowl</b> Cubela de apoio Era Small / Vasque à poser Era Small / Aufsatzbecken Runde Era Small / Раковина круглый Era Small</p>	ø40 x 15 h	BAERA40(X)*	8,00	<ul style="list-style-type: none"> <li> <b>Gloss White</b></li> <li> <b>Le Terre di Cielo</b></li> <li> <b>Le Acque di Cielo</b></li> </ul>	<b>424,00</b> <b>690,00</b> <b>690,00</b>	26	52
  <p><b>Oval on top bowl Eco 62</b> Cubela de apoio Eco oval 62 / Vasque à poser Eco ovale 62 / Aufsatzbecken Oval Eco 62 / Раковина овальный Eco 62</p>	62 x 45 x 18 h	BAECO(X)*	10,50	<ul style="list-style-type: none"> <li> <b>Gloss White</b></li> <li> <b>Le Terre di Cielo</b></li> <li> <b>Le Acque di Cielo</b></li> </ul>	<b>601,00</b> <b>840,00</b> <b>840,00</b>	14	28
  <p><b>Eco Small on top bowl</b> Cubela de apoio Eco Small / Vasque à poser Eco Small / Aufsatzbecken Runde Eco Small / Раковина круглый Eco Small</p>	58 x 42 x 16,5 h	BAECO58(X)*	10,00	<ul style="list-style-type: none"> <li> <b>Gloss White</b></li> <li> <b>Le Terre di Cielo</b></li> <li> <b>Le Acque di Cielo</b></li> </ul>	<b>534,00</b> <b>788,00</b> <b>788,00</b>	16	32
  <p><b>Handy round on top bowl with one hole</b> Lavabo Handy ronda con 1 agujero ø45 / Lavabo Handy tour tour monotrou ø45 / Aufsatzbecken Runde Handy ø45 1-Loch / Раковина круглый Handy ø45 одно отверстие под смеситель</p>	ø45 x 17 h	HALAT45(X)* HALAT45SF(X)* no tap hole sin agujero sans orifice ohne Loch без отверстия	10,50	<ul style="list-style-type: none"> <li> <b>Gloss White</b></li> <li> <b>Le Terre di Cielo</b></li> <li> <b>Le Acque di Cielo</b></li> </ul>	<b>456,00</b> <b>714,00</b> <b>714,00</b>	20	34
  <p><b>Round on top washbasin 45 Mare</b> Lavabo de apoio Ronda 45 / Lavabo à poser Tour 45 / Aufsatzbecken Waschtisch Runde 45 / Раковина круглый 45</p>	ø45 x h15	MRLAT(X)*	9,00	<ul style="list-style-type: none"> <li> <b>Gloss White</b></li> <li> <b>Le Terre di Cielo</b></li> <li> <b>Le Acque di Cielo</b></li> </ul>	<b>446,00</b> <b>701,00</b> <b>701,00</b>	20	30
  <p><b>Oval on top washbasin 60 Mare</b> Lavabo à poser oval 60 / Lavabo de apoio ovale 60 / Aufsatzbecken Waschtisch Oval 60 / Раковина овальный 60</p>	60 x 38 x h15	MRLAO(X)*	12,00	<ul style="list-style-type: none"> <li> <b>Gloss White</b></li> <li> <b>Le Terre di Cielo</b></li> <li> <b>Le Acque di Cielo</b></li> </ul>	<b>541,00</b> <b>851,00</b> <b>851,00</b>	20	40

	Product code Artículo Article Artikel Артикул	Net weight (kg) Peso neto Poids net Reingewicht вес нетто	Finishes Acabados Finitions Farbe Отделки	Euro Евро
 <p><b>Universal click/clack drain in CHROME with ceramic lid</b> Válvula universal click/clack Cromado con tapa en cerámica Bonde universelle clic/clac Chromé avec clapet en céramique Universal-Ablaufgarnitur Click-Clack Chrom mit Keramikstopfen Универсальный донный клапан click/clack хром с керамической крышкой</p>	PIL01(X)*	0,40	 <b>Gloss White</b>	<b>95,00</b>
			 <b>Le Terre di Cielo</b>	<b>139,00</b>
			 <b>Le Acque di Cielo</b>	<b>139,00</b>
 <p><b>Universal click/clack drain in BLACK MATT finish with ceramic lid</b> Válvula universal click/clack Negro Matt con tapa en cerámica Bonde universelle clic/clac Noir Mat avec clapet en céramique Universal-Ablaufgarnitur Click-Clack Matt Schwarz mit Keramikstopfen Универсальный донный клапан click/clack черный матовый с керамической крышкой</p>	PIL01NM(X)*	0,40	 <b>Gloss White</b>	<b>120,00</b>
			 <b>Le Terre di Cielo</b>	<b>169,00</b>
			 <b>Le Acque di Cielo</b>	<b>169,00</b>
 <p><b>Universal click/clack drain in CEMENTO finish with ceramic lid</b> Válvula universal click/clack Cemento con tapa en cerámica Bonde universelle clic/clac Cemento avec clapet en céramique Universal-Ablaufgarnitur Click-Clack Cement mit Keramikstopfen Универсальный донный Cemento click/clack с керамической крышкой</p>	PIL01CM(X)*	0,40	 <b>Gloss White</b>	<b>120,00</b>
			 <b>Le Terre di Cielo</b>	<b>169,00</b>
			 <b>Le Acque di Cielo</b>	<b>169,00</b>
 <p><b>Universal click/clack drain in BRONZE with ceramic lid</b> Válvula universal click/clack Bronce con tapa en cerámica Bonde universelle clic/clac Bronce avec clapet en céramique Universal-Ablaufgarnitur Click-Clack Bronze mit Keramikstopfen Универсальный донный клапан click/clack бронза с керамической крышкой</p>	PIL01BR(X)*	0,40	 <b>Gloss White</b>	<b>135,00</b>
			 <b>Le Terre di Cielo</b>	<b>182,00</b>
			 <b>Le Acque di Cielo</b>	<b>182,00</b>
 <p><b>CHROMED siphon</b> Sifone Cromado \ Siphon Chromé \ Siphon Verchromt \ сифон Chrome</p>	SISP	0,93	 <b>Chrome</b>	<b>133,00</b>
 <p><b>MATT BLACK siphon</b> Sifone Negro Mate \ Siphon Noir Mat \ Siphon Schwarz Matt \ Сифон Черный матовый</p>	SIFN	0,93	 <b>Matt Black</b>	<b>194,00</b>
 <p><b>CEMENTO siphon</b> Sifone Cemento \ Siphon Cemento \ Siphon Cemento \ сифон Cemento</p>	SIFCM	0,93	 <b>Cemento</b>	<b>194,00</b>
 <p><b>BRONZE siphon</b> Sifone Bronce \ Siphon Bronze \ Siphon Bronze \ бронза сифон</p>	SIFBR	0,93	 <b>Bronze</b>	<b>220,00</b>

## Technical symbols legend

Simbolos técnicos clave / Légende symboles techniques / Technische Zeichenerklärung / Перечень технических символов

 <b>all sides are enamelled</b> con todos los lados esmaltados avec tous les côtés émaillés alle Seiten glasiert все стороны покрыты эмалью	 <b>no tap holes</b> sin agujero para grifo sans orifice robinet ohne Hahnloch без отверстия под смеситель	 <b>one tap hole</b> con 1 agujero monotrou 1-Loch одно отверстие под смеситель	 <b>no tap hole on request</b> sin agujero, solo a petición sans orifice sur demande auf Anfrage ohne Loch без отверстия под смеситель по запросу	 <b>with overflow</b> con rebosadero avec trop-plein mit Überlauf с переливом	 <b>without overflow</b> sin rebosadero sans trop-plein ohne Überlauf без слива-перелива	 <b>on top installation</b> instalación de apoyo installation à partir du plan Montage auf Platte установка на столешницу		
<b>Le Terre di Cielo</b>	 TL - Talco	 PM - Pomice	 BR - Brina	 BA - Basalto	 LV - Lavagna	 CM - Cemento	 FN - Fango	 CA - Cacao
	 AN - Arenaria	 AV - Avena	 LN - Lino	 AG - Agave	 MU - Muschio	 PL - Polvere	 CP - Cipria	 CN - Canapa
<b>Le Acque di Cielo</b>	 OL - Oltremare	 SM - Smeraldo	 AL - Alga	 CO - Corallo	 NI - Ninfea	 AM - Anemone		



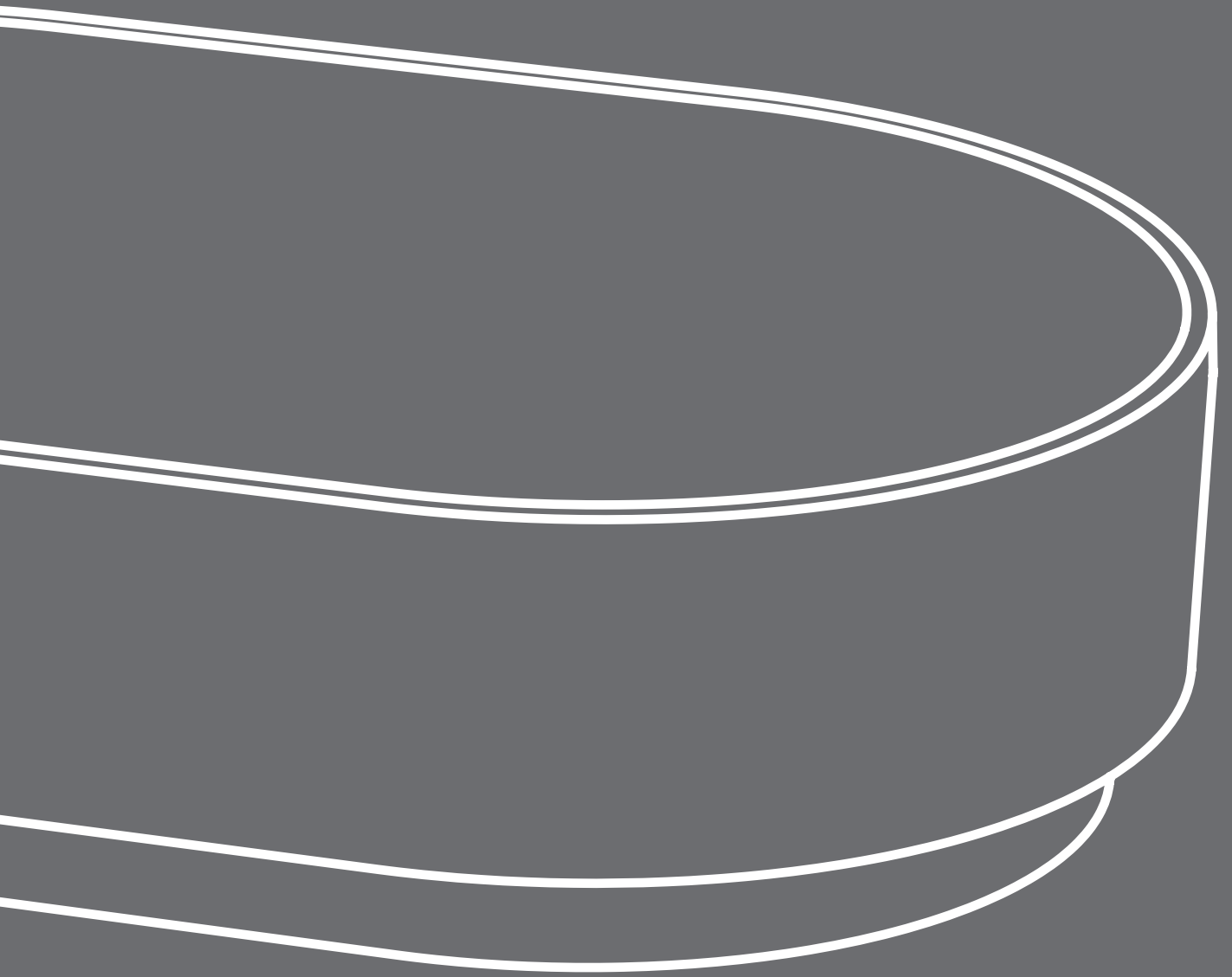

# Mare

design Matteo Thun & Antonio Rodriguez

indice collezione \ collection pg. 385

listino prezzi \ price list pg. 388 - 393

## Washbasins finishes

Acabados de Lavabos \ Finitions  
des Lavabos \ Waschbecken  
Farbe \ Отделки Раковина

 Gloss White

### Le Terre di Cielo

-  TL - Talco
-  PM - Pomice
-  BR - Brina
-  CM - Cemento
-  BA - Basalto
-  LV - Lavagna
-  FN - Fango
-  CA - Cacao
-  AN - Arenaria
-  AV - Avena
-  MU - Muschio
-  AG - Agave
-  LN - Lino
-  CN - Canapa
-  CP - Cipria
-  PL - Polvere

### Le Acque di Cielo







-  OL - Oltremare
-  SM - Smeraldo
-  AL - Alga
-  CO - Corallo
-  NI - Ninfea
-  AM - Anemone

## WC and Bidets finishes

Acabados de Sanitarios \ Finitions  
des WC et Bidets \ WC und Bidet  
Farbe \ Отделки Унитаз и Биде

 Gloss White

### Le Terre di Cielo

-  TL - Talco
-  PM - Pomice
-  BR - Brina
-  AV - Avena
-  AN - Arenaria
-  CM - Cemento
-  BA - Basalto
-  LV - Lavagna

### Le Acque di Cielo

-  OL - Oltremare
-  SM - Smeraldo
-  AL - Alga
-  CO - Corallo
-  NI - Ninfea
-  AM - Anemone

The possible variations of the colour cannot be considered as defect, but as a guarantee of the completely artisan manufacturing of this unique and high quality product. / Las variaciones de colores no se consideran un defecto sino una garantía de una elaboración manual y artesanal en un producto único y de calidad. / Les éventuelles variations de couleur ne peuvent être considérées comme des défauts, elles témoignent en revanche d'une méthode de travail totalement manuelle et artisanale employée pour obtenir un produit fini unique et de qualité. / Eventuelle Farbvariationen sind nicht als Mangel anzusehen, sondern als Garantie für die komplett handwerkliche Anfertigung eines einzigartigen und hochqualitativen Produkts. / Возможные вариации цвета не могут считаться дефектом, а являются подтверждением ручной работы, гарантией качества и уникальности изделия.

## Lavabi / washbasins

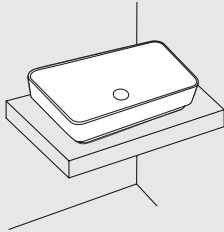

**MRLAR**  
60 x 38 x h15  
pag. 388

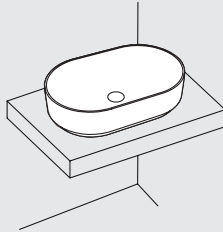

**MRLAO**  
60 x 38 x h15  
pag. 388

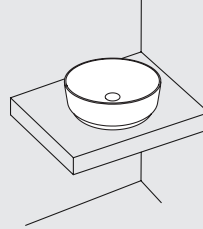

**MRLAT**  
ø 45 x h15  
pag. 388

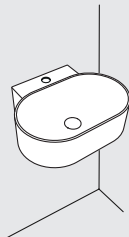

**MRLS50**  
50 x 40 x h15  
pag. 388

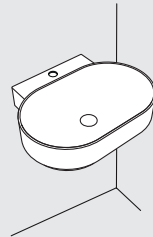

**MRLS60**  
60 x 47 x h15  
pag. 388

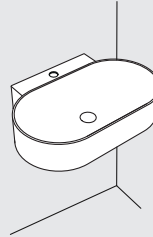

**MRLS70**  
70 x 47 x h15  
pag. 388

## Wc - bidet

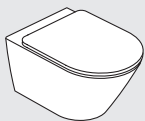

**MRVSK**  
54 x 37 x h28  
pag. 390

**CIELO RIMLESS 2.0.1®**

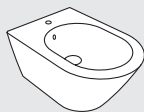

**MRBS**  
54 x 37 x h28  
pag. 391

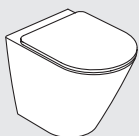

**MRVAK**  
54 x 37 x h42  
pag. 392

**CIELO RIMLESS 2.0.1®**

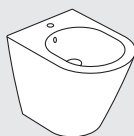

























**MRBI**  
54 x 37 x h42  
pag. 393





















































	Size (cm)	Product code	Net weight (Kg)	Finishes	Euro	Pz.	Pz.
	Medidas Dimensions Maße Размеры	Artículo Article Artikel Артикул	Peso neto Poids net Reingewicht вес нетто	Acabados Finitions Farbe Отделки	Евро	шт. pallet Italia	шт. pallet Cont.
 <p><b>Rectangular on top washbasin 60</b> Lavabo de apoyo rectangular 60 Lavabo rectangulaire 60 Aufsatzbecken Waschtisch rechteckig 60 Раковина прямоугольная 60</p>	60 x 38 x h15	MRLAR(X)*	13,00	<ul style="list-style-type: none"> <li> Gloss White</li> <li> Le Terre di Cielo</li> <li> Le Acque di Cielo</li> </ul>	565,00 864,00 864,00	20	40
 <p><b>Oval on top washbasin 60</b> Lavabo à poser oval 60 Lavabo de apoyo ovale 60 Aufsatzbecken Waschtisch Oval 60 Раковина овальный 60</p>	60 x 38 x h15	MRLAO(X)*	12,00	<ul style="list-style-type: none"> <li> Gloss White</li> <li> Le Terre di Cielo</li> <li> Le Acque di Cielo</li> </ul>	541,00 851,00 851,00	20	40
 <p><b>Round on top washbasin 45</b> Lavabo de apoyo Ronda 45 Lavabo à poser Tour 45 Aufsatzbecken Waschtisch Runde 45 Раковина круглый 45</p>	ø45 x h15	MRLAT(X)*	9,00	<ul style="list-style-type: none"> <li> Gloss White</li> <li> Le Terre di Cielo</li> <li> Le Acque di Cielo</li> </ul>	446,00 701,00 701,00	20	30
 <p><b>Oval wall-hung washbasin with one hole 50</b> Lavabo suspendido oval con 1 agujero 50 Lavabo suspendu ovale monotrou 50 Aufsatzbecken Hängender Oval 1-Loch 50 Раковина подвесная овальный одно отверстие под смеситель 50</p>	50 x 40 x h15	MRLS50(X)* MRLS50SF(X)* no tap hole sin agujero sans orifice ohne Loch без отверстия	11,50	<ul style="list-style-type: none"> <li> Gloss White</li> <li> Le Terre di Cielo</li> <li> Le Acque di Cielo</li> </ul>	492,00 727,00 727,00	20	40
 <p><b>Oval wall-hung washbasin with one hole 60</b> Lavabo suspendido oval con 1 agujero 60 Lavabo suspendu ovale monotrou 60 Aufsatzbecken Hängender Oval 1-Loch 60 Раковина подвесная овальный одно отверстие под смеситель 60</p>	60 x 47 x h15	MRLS60(X)* MRLS60SF(X)* no tap hole sin agujero sans orifice ohne Loch без отверстия	15,00	<ul style="list-style-type: none"> <li> Gloss White</li> <li> Le Terre di Cielo</li> <li> Le Acque di Cielo</li> </ul>	576,00 821,00 821,00	14	21
 <p><b>Oval wall-hung washbasin with one hole 70</b> Lavabo suspendido oval con 1 agujero 70 Lavabo suspendu ovale monotrou 70 Aufsatzbecken Hängender Oval 1-Loch 70 Раковина подвесная овальный одно отверстие под смеситель 70</p>	70 x 47 x h15	MRLS70(X)* MRLS70SF(X)* no tap hole sin agujero sans orifice ohne Loch без отверстия	17,00	<ul style="list-style-type: none"> <li> Gloss White</li> <li> Le Terre di Cielo</li> <li> Le Acque di Cielo</li> </ul>	619,00 868,00 868,00	14	21
<p>art. MRLS50/MRLS50SF/MRLS60/MRLS60SF/MRLS70/MRLS70SF For on top installation customers are advised to the require the "RETTIFICA" option. Para instalaciones de apoyo se aconseja usar la opción "RETTIFICA" / Pour l'installation à poser on conseille l'option "RETTIFICA" / Bei Aufsatzmontage bitte die Option "RETTIFICA" anfragen / При установке на столешницу рекомендуется запросить опцию "RETTIFICA".</p>		RETTIFICA GRINDING			10,00		

	<b>Product code</b> Artículo Article Artikel Артикул	<b>Net weight</b> (Kg) Peso neto Poids net Reingewicht вес нетто	<b>Finishes</b> Acabados Finitions Farbe Отделка	<b>Euro</b> Евро
	<b>Universal click/clack drain in CHROME with ceramic lid</b> Válvula universal click/clack Cromado con tapa en cerámica Bonde universelle clic/clac Chromé avec clapet en céramique Universal-Ablaufgarnitur Click-Clack Chrom mit Keramikstopfen Универсальный донный клапан click/clack хром с керамической крышкой	PIL01(X)*	0,40	<ul style="list-style-type: none"> <li> <b>Gloss White</b> <b>95,00</b></li> <li> <b>Le Terre di Cielo</b> <b>139,00</b></li> <li> <b>Le Acque di Cielo</b> <b>139,00</b></li> </ul>
	<b>Universal click/clack drain in BLACK MATT finish with ceramic lid</b> Válvula universal click/clack Negro Matt con tapa en cerámica Bonde universelle clic/clac Noir Mat avec clapet en céramique / Universal-Ablaufgarnitur Click-Clack Matt Schwarz mit Keramikstopfen / Универсальный донный клапан click/clack черный матовый с керамической крышкой	PIL01NM(X)*	0,40	<ul style="list-style-type: none"> <li> <b>Gloss White</b> <b>120,00</b></li> <li> <b>Le Terre di Cielo</b> <b>169,00</b></li> <li> <b>Le Acque di Cielo</b> <b>169,00</b></li> </ul>
	<b>Universal click/clack drain in CEMENTO finish with ceramic lid</b> Válvula universal click/clack Cemento con tapa en cerámica Bonde universelle clic/clac Cemento avec clapet en céramique Universal-Ablaufgarnitur Click-Clack Cement mit Keramikstopfen Универсальный донный Cemento click/clack с керамической крышкой	PIL01CM(X)*	0,40	<ul style="list-style-type: none"> <li> <b>Gloss White</b> <b>120,00</b></li> <li> <b>Le Terre di Cielo</b> <b>169,00</b></li> <li> <b>Le Acque di Cielo</b> <b>169,00</b></li> </ul>
	<b>Universal click/clack drain in BRONZE with ceramic lid</b> Válvula universal click/clack Bronce con tapa en cerámica Bonde universelle clic/clac Bronze avec clapet en céramique Universal-Ablaufgarnitur Click-Clack Bronze mit Keramikstopfen Универсальный донный клапан click/clack бронза с керамической крышкой	PIL01BR(X)*	0,40	<ul style="list-style-type: none"> <li> <b>Gloss White</b> <b>135,00</b></li> <li> <b>Le Terre di Cielo</b> <b>182,00</b></li> <li> <b>Le Acque di Cielo</b> <b>182,00</b></li> </ul>
	<b>CHROMED siphon</b> Sifone Cromado \ Siphon Chromé \ Siphon Verchromt \ сифон Chrome	SISP	0,93	<ul style="list-style-type: none"> <li> <b>Chrome</b> <b>133,00</b></li> </ul>
	<b>MATT BLACK siphon</b> Sifone Negro Mate \ Siphon Noir Mat \ Siphon Schwarz Matt \ Сифон Черный матовый	SIFN	0,93	<ul style="list-style-type: none"> <li> <b>Matt Black</b> <b>194,00</b></li> </ul>
	<b>CEMENTO siphon</b> Sifone Cemento \ Siphon Cemento \ Siphon Cemento \ сифон Cemento	SIFCM	0,93	<ul style="list-style-type: none"> <li> <b>Cemento</b> <b>194,00</b></li> </ul>
	<b>BRONZE siphon</b> Sifone Bronce \ Siphon Bronze \ Siphon Bronze \бронза сифон	SIFBR	0,93	<ul style="list-style-type: none"> <li> <b>Bronze</b> <b>220,00</b></li> </ul>

**Technical symbols legend** / Símbolos técnicos clave / Légende symboles techniques / Technische Zeichenerklärung / Перечень технических символов

 <b>with 1 hole prepared 3 holes</b> con 1 agujero predispueto para 3 / avec un trou prédisposé à trois trous \ mit 1-Loch auf 3-Loch durchschlagbar \ одно отверстие с возможностью выполнения трех отверстий	 <b>no tap hole on request</b> sin agujero, solo a petición sans orifice sur demande auf Anfrage ohne Loch без отверстия под смеситель по запросу	 <b>without overflow</b> sin rebosadero sans trop-plein ohne Überlauf без слива-перелива	 <b>one side is unglazed</b> con un lado sin esmaltar avec un côté non émaillé eine Seite unglasiert одна сторона не покрыта эмалью	 <b>all sides are enamelled</b> con todos los lados esmaltados avec tous les côtés émaillés alle Seiten glasiert все стороны покрыты эмалью	 <b>on top installation</b> instalación de apoyo installation à partir du plan Montage auf Platte установка на столешницу	 <b>wall-hung installation</b> instalación suspendida installation suspendue wandhängende Montage подвесная установка	
 <b>TL - Talco</b>	 <b>PM - Pomice</b>	 <b>BR - Brina</b>	 <b>BA - Basalto</b>	 <b>LV - Lavagna</b>	 <b>CM - Cemento</b>	 <b>FN - Fango</b>	 <b>CA - Cacao</b>
 <b>AN - Arenaria</b>	 <b>AV - Avena</b>	 <b>LN - Lino</b>	 <b>AG - Agave</b>	 <b>MU - Muschio</b>	 <b>PL - Polvere</b>	 <b>CP - Cipria</b>	 <b>CN - Canapa</b>
 <b>OL - Oltremare</b>	 <b>SM - Smeraldo</b>	 <b>AL - Alga</b>	 <b>CO - Corallo</b>	 <b>NI - Ninfea</b>	 <b>AM - Anemone</b>		

 	<b>Size (cm)</b> Medidas Dimensions Maße Размеры	<b>Product code</b> Artículo Article Artikel Артикул	<b>Net weight (Kg)</b> Peso neto Poids net Reingewicht вес нетто	<b>Finishes</b> Acabados Finitions Farbe Отделки	<b>Euro</b> Евро	<b>Pz.</b> шт. pallet Italia	<b>Pz.</b> шт. pallet Cont.
 <p><b>Wall-hung wc with fixing kit (4,5 LT) - rimless 2.0.1</b>                      Inodoro suspendido completo con fijaciones (4.5 LT) - sin brida - rimless 2.0.1 / Cuvette suspendue avec fixations (4.5 LT) - sans bride - rimless 2.0.1 / Wand-WC mit Befestigungskit (4,5 lt.) - ohne Spülrand - rimless 2.0.1 / Подвесной унитаз в комплекте с крепежами (4,5 литр) - без ободка - rimless 2.0.1</p>	54 x 37 x h 28	MRVSK(X)*	18,00	<ul style="list-style-type: none"> <li> <b>Gloss White</b></li> <li> <b>*X = TL - Talco</b></li> <li> <b>Le Terre di Cielo *</b></li> <li> <b>Le Acque di Cielo</b></li> </ul>	480,00 692,00 711,00 711,00	18	18
 <p><b>QUICK RELEASE HINGES</b>   <b>Thermosetting seat &amp; cover</b>                      Asiento para inodoro                      Abattant thermdurcissable                      Wc-sitz thermotur                      Сиденье из термоотверждающейся смолы</p>		CPVMRT(X)*	2,50	<ul style="list-style-type: none"> <li> <b>Gloss White</b></li> </ul>	110,00		
 <p><b>QUICK RELEASE HINGES</b>   <b>Thermosetting soft close seat &amp; cover</b>                      Asiento para inodoro amortiguado                      Abattant thermdurcissable soft                      Wc-sitz thermotur mit Abs.                      Сиденье из термоотверждающейся смолы с плавным опусканием</p>		CPVMRTF(X)*	2,50	<ul style="list-style-type: none"> <li> <b>Gloss White</b></li> <li> <b>*X = TL - Talco</b></li> <li> <b>Le Terre di Cielo *</b></li> <li> <b>Le Acque di Cielo</b></li> </ul>	188,00 296,00 316,00 316,00		
 <p><b>Impact and acoustic protection panel</b>                      Protección antigolpes y acústica                      Protection acoustique et anti-choc                      Stoss- und Schalldämmung                      Противоударная и акустическая защита</p>		PAA	0,16		17,00		
 <p><b>Couple of fixing brackets for wall-hung wc/bidet</b>                      Pareja de estribo para Inodoro/Bidet suspendido                      Étriers de fixation pour Wc/Bidet suspendus                      1 Paar Halterungen für wandhängendes Wc/Bidet                      Монтажная рама для подвесного унитаза/биде</p>	3,3 x 18,5 x h 55	508	2,00		39,00		

### Technical symbols legend

Símbolos técnicos clave / Légende symboles techniques / Technische Zeichenerklärung / Перечень технических символов

























-  **wall-hung installation** / instalación suspendida / installation suspendue / wandhängende Montage / подвесная установка
-  **with fixing parts** / fijaciones incluidas / fixations incluses / inklusive Befestigungen / в комплекте с крепежами
-  **4,5 l toilet tank** / descarga 4,5 lt / évacuation à 4,5 l / 4,5 l-Spülung / бачок на 4,5 л
-  **Combifix compatibility** / compatible Combifix / mit Combifix kompatibel / совместим с combifix
-  **quick release hinge** / sistema extraíble / charnières à ouverture / Takeoff Funktion / быстрый съем

**Acque di Cielo available for wc-bidet** / Acque di Cielo disponibles para wc-bidet / Acque di Cielo disponibles pour cuvette-bidet / Für das WC/Bidet erhältliche Ausführungen Acque di Cielo / Отделки Acque di Cielo доступны для унитаза и биде

-  **OL - Oltremare**
-  **SM - Smeraldo**
-  **AL - Alga**
-  **CO - Corallo**
-  **NI - Ninfea**
-  **AM - Anemone**

**\* Terre di Cielo finishes available for wc-bidet** / Acabados Terre di Cielo disponibles para wc-bidet / Finitions Terre di Cielo disponibles pour cuvette-bidet / Für das WC/Bidet erhältliche Ausführungen Terre di Cielo / отделки Terre di Cielo доступны для унитаза и биде

-  **TL - Talco**
-  **PM - Pomice**
-  **BR - Brina**
-  **AN - Arenaria**
-  **AV - Avena**
-  **CM - Cemento**
-  **BA - Basalto**
-  **LV - Lavagna**

	Size (cm) Medidas Dimensions Maße Размеры	Product code Artículo Article Artikel Артикул	Net weight (Kg) Peso neto Poids net Reingewicht вес нетто	Finishes Acabados Finitions Farbe Отделки	Euro Евро	Pz. шт. pallet Italia	Pz. шт. pallet Cont.
  <p><b>Wall-hung one hole bidet with fixing kit</b> Bidé suspendido monoagujero completo con fijaciones / Bidet suspendu monotrou avec fixation / Wand-Bidet einloch mit BefestigungsKit / Биде подвесное с одним отверстием под смеситель, в комплекте с крепежами</p>	54 x 37 x h28	MRBS(X)*	19,00	<ul style="list-style-type: none"> <li> <b>Gloss White</b></li> <li> *X = TL - Talco</li> <li> <b>Le Terre di Cielo *</b></li> <li> <b>Le Acque di Cielo</b></li> </ul>	480,00 692,00 711,00 711,00	18	18
 <p><b>Impact and acoustic protection panel</b> / Protección antigolpes y acústica / Protection acoustique et anti-choc / Stoss- und Schalldämmung / Противоударная и акустическая защита</p>		PAA	0,16		17,00		
 <p><b>Couple of fixing brackets for wall-hung wc/bidet</b> - Pareja de estribo para Inodoro/Bidet suspendido / Étriers de fixation pour Wc/Bidet suspendus / 1 Paar Halterungen für wandhängendes Wc/Bidet / Монтажная рама для подвесного унитаза/биде</p>	3,3 x 18,5 x 55 h	508	2,00		39,00		
 <p><b>Universal click/clack drain in CHROME with ceramic lid</b> Válvula universal click/clack Cromado con tapa en cerámica / Bonde universelle clic/clac Chromé avec clapet en céramique / Universal-Ablaufgarnitur Click-Clack Chrom mit Keramikstopfen / Универсальный донный клапан click/clack хром с керамической крышкой</p>		PIL01(X)*	0,40	<ul style="list-style-type: none"> <li> <b>Gloss White</b></li> <li> <b>Le Terre di Cielo</b></li> <li> <b>Le Acque di Cielo</b></li> </ul>	95,00 139,00 139,00		
 <p><b>Universal click/clack drain in BLACK MATT finish with ceramic lid</b> Válvula universal click/clack Negro Matt con tapa en cerámica / Bonde universelle clic/clac Noir Mat avec clapet en céramique / Universal-Ablaufgarnitur Click-Clack Matt Schwarz mit Keramikstopfen / Универсальный донный клапан click/clack черный матовый с керамической крышкой</p>		PIL01NM(X)*	0,40	<ul style="list-style-type: none"> <li> <b>Gloss White</b></li> <li> <b>Le Terre di Cielo</b></li> <li> <b>Le Acque di Cielo</b></li> </ul>	120,00 169,00 169,00		
 <p><b>Universal click/clack drain in CEMENTO finish with ceramic lid</b> Válvula universal click/clack Cemento con tapa en cerámica / Bonde universelle clic/clac Cemento avec clapet en céramique / Universal-Ablaufgarnitur Click-Clack Cement mit Keramikstopfen / Универсальный донный клапан click/clack с керамической крышкой</p>		PIL01CM(X)*	0,40	<ul style="list-style-type: none"> <li> <b>Gloss White</b></li> <li> <b>Le Terre di Cielo</b></li> <li> <b>Le Acque di Cielo</b></li> </ul>	120,00 169,00 169,00		
 <p><b>Universal click/clack drain in BRONZE with ceramic lid</b> Válvula universal click/clack Bronce con tapa en cerámica / Bonde / Universal-Ablaufgarnitur Click-Clack Bronze mit Keramikstopfen / Универсальный донный клапан click/clack бронза с керамической крышкой</p>		PIL01BR(X)*	0,40	<ul style="list-style-type: none"> <li> <b>Gloss White</b></li> <li> <b>Le Terre di Cielo</b></li> <li> <b>Le Acque di Cielo</b></li> </ul>	135,00 182,00 182,00		

## Technical symbols legend

Símbolos técnicos clave / Légende symboles techniques / Technische Zeichenerklärung / Перечень технических символов



















 <p><b>with overflow</b> con rebosadero avec trop-plein mit Überlauf с переливом</p>	 <p><b>one tap hole</b> con 1 agujero monotrou 1-Loch одно отверстие под смеситель</p>	 <p><b>wall-hung installation</b> instalación suspendida installation suspendue wandhängende Montage подвесная установка</p>	 <p><b>with fixing parts</b> fijaciones incluidas fixations incluses inklusive Befestigungen в комплекте с крепежами</p>
--	---	---	---

Acque di Cielo available for wc-bidet / Acque di Cielo disponibles para wc-bidet / Acque di Cielo disponibles pour cuvette-bidet / Für das WC/Bidet erhältliche Ausführungen Acque di Cielo / Отделки Acque di Cielo доступны для унитаза и биде

 OL - Oltremare  SM - Smeraldo  AL - Alga  CO - Corallo  NI - Ninfea  AM - Anemone

\* Terre di Cielo finishes available for wc-bidet / Acabados Terre di Cielo disponibles para wc-bidet / Finitions Terre di Cielo disponibles pour cuvette-bidet / Für das WC/Bidet erhältliche Ausführungen Terre di Cielo / Отделки Terre di Cielo доступны для унитаза и биде

 TL - Talco  PM - Pomice  BR - Brina  AN - Arenaria  AV - Avena  CM - Cemento  
 BA - Basalto  LV - Lavagna

 	<b>Size (cm)</b> Medidas Dimensions Maße Размеры	<b>Product code</b> Artículo Article Artikel Артикул	<b>Net weight (Kg)</b> Peso neto Poids net Reingewicht вес нетто	<b>Finishes</b> Acabados Finitions Farbe Отделка	<b>Euro</b> Евро	<b>Pz.</b> шт. pallet Italia	<b>Pz.</b> шт. pallet Cont.
 <p><b>Wc with horizontal outlet convertible to floor outlet by technical curve (4,5 LT) - rimless 2.0.1</b>                      Wc con desagüe a pared convertible a suelo con curva técnica (4,5 LT) - sin brida - rimless 2.0.1 \ Wc avec évacuation murale transformable à terre avec courbe technique (4,5L) - sans bride - rimless 2.0.1 \ WC mit Wandabfluss, durch Kurventechnik auf Bodenabfluss umrüstbar (4,5 LT) - ohne Spülrand - rimless 2.0.1 \ Слив в стену при помощи технического колена трансформируется на слив в пол (4,5 л) - без ободка</p>	54 x 37 x h42	MRVAK(X)*	24,00	<ul style="list-style-type: none"> <li> <b>Gloss White</b></li> <li> <b>*X = TL - Talco</b></li> <li> <b>Le Terre di Cielo *</b></li> <li> <b>Le Acque di Cielo</b></li> </ul>	480,00 692,00 711,00 711,00	15	20
<p><b>QUICK RELEASE HINGES</b> </p> <p><b>Thermosetting seat &amp; cover</b>                      Asiento para inodoro                      Abattant thermodurcissable                      Wc-sitz thermotur                      Сиденье из термоотверждающейся смолы</p> 		CPVMRT(X)*	2,50	<ul style="list-style-type: none"> <li> <b>Gloss White</b></li> </ul>	110,00		
<p><b>QUICK RELEASE HINGES</b> </p> <p><b>Thermosetting soft close seat &amp; cover</b>                      Asiento para inodoro amortiguado                      Abattant thermodurcissable soft                      Wc-sitz thermotur mit Abs.                      Сиденье из термоотверждающейся смолы с плавным опусканием</p> 		CPVMRTF(X)*	2,50	<ul style="list-style-type: none"> <li> <b>Gloss White</b></li> <li> <b>*X = TL - Talco</b></li> <li> <b>Le Terre di Cielo *</b></li> <li> <b>Le Acque di Cielo</b></li> </ul>	188,00 296,00 316,00 316,00		
<p><b>Technical curve "floor trap" for toilet / Curva técnica "salida vertical" para inodoro</b>                      Courbe technique à S pour cuvette avec sortie au sol                      WC-Ablaufbogen "S"                      Колено "S"-образное для унитазов, регулируемое</p> 		CSB	0,40		18,00		
<p><b>Straight pan connector for wall trap / Anclaje a pared para inodoro</b>                      Pipe pour sortie horizontale                      WC-Anschlussstutzen für Abgang waagerecht                      Фитинг для выпуска в стену для унитазов</p> 		RPB	0,35		15,00		

### Technical symbols legend

Simbolos técnicos clave | Légende symboles techniques | Technische Zeichenerklärung | Перечень технических символов

























-  **back to wall installation**  
instalación a suelo / installation à terre / bodenstehende Montage  
напольная установка
-  **with fixing parts**  
fijaciones incluidas / fixations incluses / inklusive Befestigungen  
в комплекте с крепежами
-  **4,5 l toilet tank**  
descarga 4,5 lt / évacuation à 4,5 l  
4,5 l-Spülung / бачок на 4,5 л
-  **bifunctional drain**  
descarga bifuncional / évacuation bifonctionnelle  
Spülung mit zwei Montagevarianten /  
унифункциональный бачок
-  **quick release hinge**  
sistema extraíble / charnières à ouverture  
Takeoff Funktion / быстрый съём

Acque di Cielo available for wc-bidet | Acque di Cielo disponibles para wc-bidet | Acque di Cielo disponibles pour cuvette-bidet | Für das WC/Bidet erhältliche Ausführungen Acque di Cielo | Отделка Acque di Cielo доступны для унитаза и биде

-  **OL - Oltremare**
-  **SM - Smeraldo**
-  **AL - Alga**
-  **CO - Corallo**
-  **NI - Ninfea**
-  **AM - Anemone**

\* Terre di Cielo finishes available for wc-bidet | Acabados Terre di Cielo disponibles para wc-bidet | Finitions Terre di Cielo disponibles pour cuvette-bidet | Für das WC/Bidet erhältliche Ausführungen Terre di Cielo | Отделка Terre di Cielo доступны для унитаза и биде

-  **TL - Talco**
-  **PM - Pomicc**
-  **BR - Brina**
-  **AN - Arenaria**
-  **AV - Avena**
-  **CM - Cemento**
-  **BA - Basalto**
-  **LV - Lavagna**

	Size (cm)	Product code	Net weight (Kg)	Finishes	Euro	Pz.	Pz.
	Medidas Dimensions Maße Размеры	Artículo Article Artikel Артикул	Peso neto Poids net Reingewicht вес нетто	Acabados Finitions Farbe Отделка	Евро	шт. pallet Italia	шт. pallet Cont.
     <p><b>Back to wall one hole bidet</b> Bidé a suelo monoagujero Bidet monotrou Stand-Bidet einloch Биде напольное с одним отверстием под смеситель</p>	54 x 37 x h42	MRBI(X)*	22,00	<ul style="list-style-type: none"> <li> <b>Gloss White</b></li> <li> <b>*X = TL - Talco</b></li> <li> <b>Le Terre di Cielo *</b></li> <li> <b>Le Acque di Cielo</b></li> </ul>	<ul style="list-style-type: none"> <li><b>480,00</b></li> <li><b>692,00</b></li> <li><b>711,00</b></li> <li><b>711,00</b></li> </ul>	15	20
 <p><b>Universal click/clack drain in CHROME with ceramic lid</b> Válvula universal click/clack Cromado con tapa en cerámica Bonde universelle clic/clac Chromé avec clapet en céramique Universal-Abflussgarnitur Click-Clack Chrom mit Keramikstopfen Универсальный донный клапан click/clack хром с керамической крышкой</p>		PIL01(X)*	0,40	<ul style="list-style-type: none"> <li> <b>Gloss White</b></li> <li> <b>Le Terre di Cielo</b></li> <li> <b>Le Acque di Cielo</b></li> </ul>	<ul style="list-style-type: none"> <li><b>95,00</b></li> <li><b>139,00</b></li> <li><b>139,00</b></li> </ul>		
 <p><b>Universal click/clack drain in BLACK MATT finish with ceramic lid</b> / Válvula universal click/clack Negro Matt con tapa en cerámica / Bonde universelle clic/clac Noir Mat avec clapet en céramique Universal-Abflussgarnitur Click-Clack Matt Schwarz mit Keramikstopfen Универсальный донный клапан click/clack черный матовый с керамической крышкой</p>		PIL01NM(X)*	0,40	<ul style="list-style-type: none"> <li> <b>Gloss White</b></li> <li> <b>Le Terre di Cielo</b></li> <li> <b>Le Acque di Cielo</b></li> </ul>	<ul style="list-style-type: none"> <li><b>120,00</b></li> <li><b>169,00</b></li> <li><b>169,00</b></li> </ul>		
 <p><b>Universal click/clack drain in CEMENTO finish with ceramic lid</b> / Válvula universal click/clack Cemento con tapa en cerámica / Bonde universelle clic/clac Cemento avec clapet en céramique Universal-Abflussgarnitur Click-Clack Cement mit Keramikstopfen Универсальный донный Cemento click/clack с керамической крышкой</p>		PIL01CM(X)*	0,40	<ul style="list-style-type: none"> <li> <b>Gloss White</b></li> <li> <b>Le Terre di Cielo</b></li> <li> <b>Le Acque di Cielo</b></li> </ul>	<ul style="list-style-type: none"> <li><b>120,00</b></li> <li><b>169,00</b></li> <li><b>169,00</b></li> </ul>		
 <p><b>Universal click/clack drain in BRONZE with ceramic lid</b> Válvula universal click/clack Bronze con tapa en cerámica Bonde universelle clic/clac Bronze avec clapet en céramique Universal-Abflussgarnitur Click-Clack Bronze mit Keramikstopfen Универсальный донный клапан click/clack бронза с керамической крышкой</p>		PIL01BR(X)*	0,40	<ul style="list-style-type: none"> <li> <b>Gloss White</b></li> <li> <b>Le Terre di Cielo</b></li> <li> <b>Le Acque di Cielo</b></li> </ul>	<ul style="list-style-type: none"> <li><b>135,00</b></li> <li><b>182,00</b></li> <li><b>182,00</b></li> </ul>		

## Technical symbols legend

*Símbolos técnicos clave | Légende symboles techniques | Technische Zeichenerklärung | Перечень технических символов*

 <p><b>with overflow</b> con rebosadero / avec trop-plein / mit Überlauf с переливом</p>	 <p><b>one tap hole</b> con 1 agujero / monotrou / 1-Loch одно отверстие под смеситель</p>	 <p><b>back to wall installation</b> instalación a suelo / installation à terre bodenstehende Montage / напольная установка</p>	 <p><b>with fixing parts</b> fijaciones incluidas / fixations incluses inklusive Befestigungen / в комплекте с крепежами</p>
--	---	--	---

**Acque di Cielo available for wc-bidet** / Acque di Cielo disponibles para wc-bidet / Acque di Cielo disponibles pour cuvette-bidet / Für das WC/Bidet erhältliche Ausführungen Acque di Cielo / Отделка Acque di Cielo доступны для унитаза и биде

 **OL - Oltremare**
 **SM - Smeraldo**
 **AL - Alga**
 **CO - Corallo**
 **NI - Ninfea**
 **AM - Anemone**

**\* Terre di Cielo finishes available for wc-bidet** / Acabados Terre di Cielo disponibles para wc-bidet / Finitions Terre di Cielo disponibles pour cuvette-bidet / Für das WC/Bidet erhältliche Ausführungen Terre di Cielo / отделка Terre di Cielo доступны для унитаза и биде

 **TL - Talco**
 **PM - Pomice**
 **BR - Brina**
 **AN - Arenaria**
 **AV - Avena**
 **CM - Cemento**  
 **BA - Basalto**
 **LV - Lavagna**



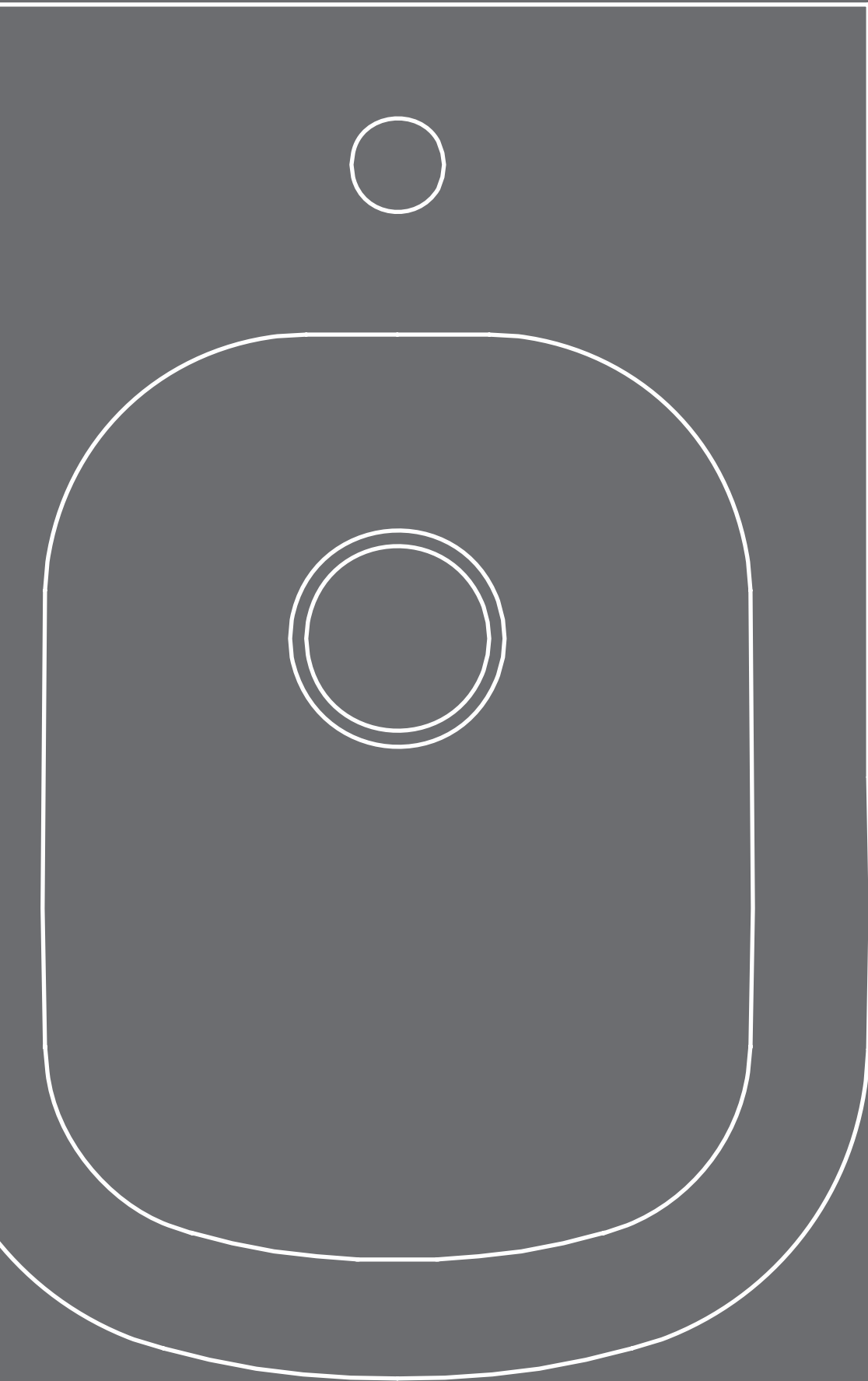

# Era

design Luca Cimarra

indice collezione \ collection pg. 396 - 397

listino prezzi \ price list pg. 399 - 410

Lavabi / washbasins

45



**ERLA45**  
45 x 34 x 14 h  
pag. 399

48

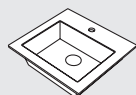

**ERLA48**  
48 x 46 x 14 h  
pag. 399

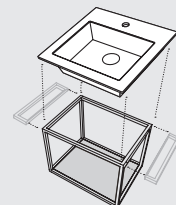

60

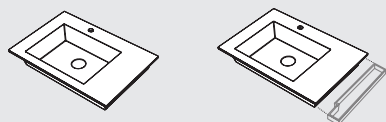

**ERLA60SX**  
60 x 46 x 14 h  
pag. 400

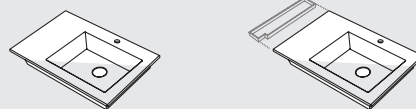

**ERLA60DX**  
60 x 46 x 14 h  
pag. 400

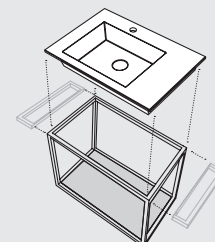

80

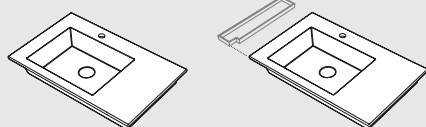

**ERLA80SX**  
80 x 46 x 14 h  
pag. 401

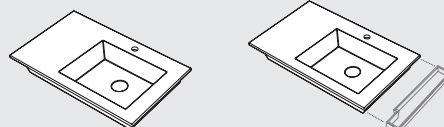

**ERLA80DX**  
80 x 46 x 14 h  
pag. 401

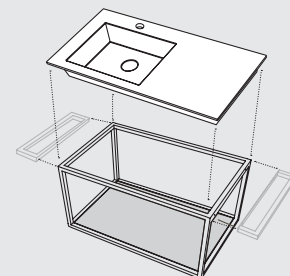

100

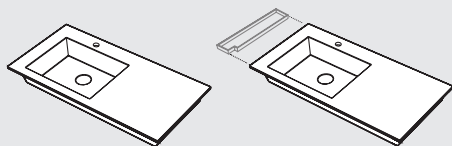

**ERLA100SX**  
100 x 46 x 14 h  
pag. 402

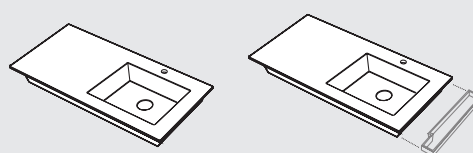

**ERLA100DX**  
100 x 46 x 14 h  
pag. 402

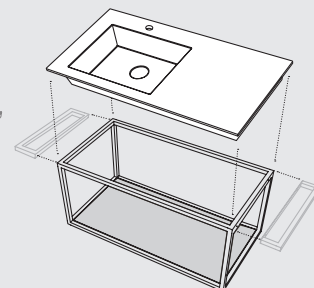

120

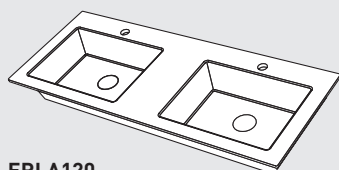

**ERLA120**  
120 x 46 x 14 h  
pag. 403

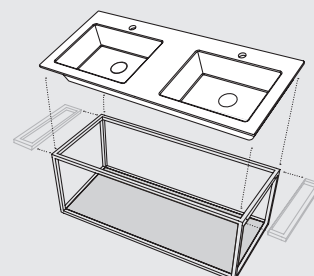

## Bacinelle / bowls



**BAECO**  
62 x 45 x 18 h  
pag. 404



**BAECO58**  
58 x 42 x 16,5 h  
pag. 404



**BAERA**  
ø45 x 24 h  
pag. 404



**BAERA40**  
ø40 x 15 h  
pag. 404



**HALAT45**  
ø45 x 17 h  
pag. 404

## Wc - bidet

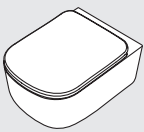

**ERVSK**  
53 x 36,5 x 37 h  
pag. 406

**CIELO RIMLESS 2.01®**

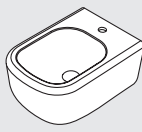

**ERBS**  
53 x 36,5 x 30 h  
pag. 407

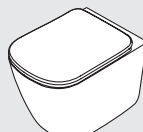

**ERVAK**  
52 x 36,5 x 42 h  
pag. 408

**CIELO RIMLESS 2.01®**

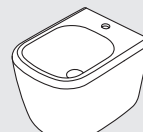

**ERBI**  
52 x 36,5 x 42 h  
pag. 409

## Urinal



**EROR**  
33,5 x 27 x 63 h  
pag. 410

## Washbasins finishes

Acabados de Lavabos \ Finitions des Lavabos \ Waschbecken Farbe \ Отделки Раковина

○ Gloss White

## Le Terre di Cielo

- TL - Talco
- PM - Pomice
- BR - Brina
- CM - Cemento
- BA - Basalto
- LV - Lavagna
- FN - Fango
- CA - Cacao
- AN - Arenaria
- AV - Avena
- MU - Muschio
- AG - Agave
- LN - Lino
- CN - Canapa
- CP - Cipria
- PL - Polvere

## Le Acque di Cielo

(Le Bacinelle)

- OL - Oltremare
- SM - Smeraldo
- AL - Alga
- CO - Corallo
- NI - Ninfea
- AM - Anemone

## WC and Bidets finishes

Acabados de Sanitarios \ Finitions des WC et Bidets \ WC und Bidet Farbe \ Отделки Унитаз и Биде

○ Gloss White

## Le Terre di Cielo

- TL - Talco
- PM - Pomice
- BR - Brina
- AV - Avena
- AN - Arenaria
- CM - Cemento
- BA - Basalto
- LV - Lavagna

## Le Acque di Cielo

- OL - Oltremare
- SM - Smeraldo
- AL - Alga
- CO - Corallo
- NI - Ninfea
- AM - Anemone

## Urinal finishes

Acabados de Urinario \ Finitions de l'urinoir \ Urinal Farbe \ Отделки писсуар

○ Gloss White

## Le Terre di Cielo

- TL - Talco
- PM - Pomice
- BR - Brina
- CM - Cemento
- BA - Basalto
- LV - Lavagna
- FN - Fango
- CA - Cacao
- AN - Arenaria
- AV - Avena
- MU - Muschio
- AG - Agave
- LN - Lino
- CN - Canapa
- CP - Cipria
- PL - Polvere















## Structure finishes

Estructura \ Structure \ Gestell \ Структура

- NM - Black Matt
- CM - Cemento

The possible variations of the colour cannot be considered as defect, but as a guarantee of the completely artisan manufacturing of this unique and high quality product. / Las variaciones de colores no se consideran un defecto sino una garantía de una elaboración manual y artesanal en un producto único y de calidad. / Les éventuelles variations de couleur ne peuvent être considérées comme des défauts, elles témoignent en revanche d'une méthode de travail totalement manuelle et artisanale employée pour obtenir un produit fini unique et de qualité. / Eventuelle Farbvariationen sind nicht als Mangel anzusehen, sondern als Garantie für die komplett handwerkliche Anfertigung eines einzigartigen und hochqualitativen Produkts. / Возможные вариации цвета не могут считаться дефектом, а являются подтверждением ручной работы, гарантией качества и уникальности изделия.



	Size (cm)	Product code	Net weight(Kg)	Finishes	Euro	Pz.	Pz.
	Medidas Dimensions Maße Размеры	Artículo Article Artikel Артикул	Peso neto Poids net Reingewicht вес нетто	Acabados Finitions Farbe Отделки	Eвро	шт. pallet Italia	шт. pallet Cont.
<p><b>!</b></p> <p><b>ATTENTION: towel rail holes on request \</b>                      ATENCIÓN: orificios para toallero bajo pedido \                      ATTENTION: trous porte-serviettes sur demande \                      ACHTUNG: Löcher für Handtuchhalter auf Anfrage \                      ВНИМАНИЕ: отверстия под полотенцедержатели ТОЛЬКО по запросу.</p> <p><b>Suspended washbasin 45 with left basin</b>                      Lavabo suspendido 45 lado izquierdo \ Lavabo suspendu 45                      Wandhängendes Waschbecken 45, Becken linksw \ Раковина подвесная на стену 45</p> 	45 x 34 x 14 h	ERLA45(X)*  ERLA45SF(X)* <b>no tap hole</b> sin agujero sans orifice ohne Loch без отверстия	13,00	 <b>Gloss White</b>  <b>Le Terre di Cielo</b>	303,00  425,00	28	56
	<p><b>Right-hand side towel rail for the washbasin \</b>                      Toallero dcha. para lavabo \                      Porte-serviettes droite pour vasque \ Handtuchhalter re. für Waschbecken \                      Полотенцедержатели dx на раковину</p> 	33,5 x 8,5 x 2 h	ERPL45(X)*	0,70	 <b>*X = NM - Matt Black</b>  <b>*X = CM - Cemento</b>	119,00 119,00	
<p><b>!</b></p> <p><b>Wall-hung washbasin 48</b>                      Lavabo suspendido a pared 48 \                      Lavabo suspendu 48                      Hängender waschbecken 48 \                      Раковина подвесная на стену 48</p> 	48 x 46 x 14 h	ERLA48(X)*  ERLA48SF(X)* <b>no tap hole</b> sin agujero sans orifice ohne Loch без отверстия	13,50	 <b>Gloss White</b>  <b>Le Terre di Cielo</b>	363,00 534,00	20	40
	<p><b>Structure for the washbasin 48</b>                      Estructura para lavabo 48 \ Structure pour vasque 48 \                      Gestell für Waschbecken 48 \                      Структура под раковину 48</p> <p><b>!</b>  <b>framework mandatory with washbasin</b>                      estructura obligatoria con lavabo                      structure obligatoire avec évier                      obligatorische Struktur mit Spüle                      обязательная конструкция с раковиной</p> 	48 x 46 x 40 h	ERST48(X)*	6,50	 <b>*X = NM - Matt Black</b>  <b>*X = CM - Cemento</b>	570,00 570,00	
<p><b>Right- or left-hand side towel rail for the structure</b>                      Toallero dcha-izq. para estructura \                      Porte-serviettes droite-gauche pour structure \                      Handtuchhalter re.-li. für Gestell \                      Полотенцедержатели dx-sx на структуру</p> 	46 x 6,5 x 2 h	ERPLST(X)*	0,68	 <b>*X = NM - Matt Black</b>  <b>*X = CM - Cemento</b>	157,00 157,00		





## Technical symbols legend

Simbolos técnicos clave | Légende symboles techniques | Technische Zeichenerklärung | Перечень технических символов

<p><b>without overflow</b>                      sin rebosadero                      sans trop-plein                      ohne Überlauf                      без слива-перелива</p> 	<p><b>one tap hole</b>                      con 1 agujero                      monotrou                      1-Loch                      одно отверстие под смеситель</p> 	<p><b>no tap hole on request</b>                      sin agujero, solo a petición                      sans orifice sur demande                      auf Anfrage ohne Loch                      без отверстия под смеситель по запросу</p> 	<p><b>with 1 hole prepared 3 holes</b>                      con 1 agujero preparado 3                      holes \ avec un trou prédisposé                      à trois trous \ mit 1-Loch auf 3-Loch                      durchschlagen \ одно отверстие с                      возможностью выполнения трех                      отверстий</p> 
<p><b>one side is unglazed</b>                      con un lado sin esmaltar                      avec un côté non émaillé                      eine Seite unglasiert                      одна сторона не покрыта                      эмалью</p> 	<p><b>wall-hung installation</b>                      instalación suspendida                      installation suspendue                      wandhängende Montage                      подвесная установка</p> 	<p><b>with fixing parts</b>                      fijaciones incluidas                      fixations incluses                      inklusive Befestigungen                      в комплекте с крепежами</p> 	

Le Terre di Cielo	 TL - Talco	 PM - Pomice	 BR - Brina	 BA - Basalto	 LV - Lavagna	 CM - Cemento	 FN - Fango	 CA - Cacao
	 AN - Arenaria	 AV - Avena	 LN - Lino	 AG - Agave	 MU - Muschio	 PL - Polvere	 CP - Cipria	 CN - Canapa

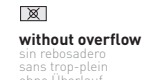

	Size (cm)	Product code	Net weight (Kg)	Finishes	Euro	Pz.	Pz.
	Medidas Dimensions Maße Размеры	Artículo Article Artikel Артикул	Peso neto Poids net Reingewicht вес нетто	Acabados Finitions Farbe Отделка	Евро	шт. pallet Italia	шт. pallet Cont.
<p><b>!</b></p> <p><b>ATTENTION: towel rail holes on request \</b> ATENCIÓN: orificios para toallero bajo pedido \ <b>ATTENTION:</b> trous porte-serviettes sur demande \ <b>ACHTUNG:</b> Löcher für Handtuchhalter auf Anfrage \ <b>ВНИМАНИЕ:</b> отверстия под полотенцедержатели ТОЛЬКО по запросу.</p> <p><b>Suspended washbasin 60 with left basin \</b> Lavabo suspendido a pared 60, seno izquierda \ Lavabo suspendu 60, vasque à gauche \ Wandhängendes Waschbecken 60, Becken links \ Раковина подвесная на стену 60, чаша слева</p> 	60 x 46 x 14 h	ERLA60SX(X)* ERLA60SXSF(X)* no tap hole sin agujero sans orifice ohne Loch без отверстия	16,00	<p>● Gloss White</p> <p>● Le Terre di Cielo</p>	485,00 702,00	20	40
<p><b>Right-hand side towel rail for the washbasin 60 \</b> Toallero dcha. para lavabo 60 \ Porte-serviettes droite pour vasque 60 \ Handtuchhalter re. für Waschbecken 60 \ Полотенцедержатели dx на раковину 60</p> 	46 x 8 x 2 h	ERPLDX(X)*	0,70	<p>● *X = NM - Matt Black</p> <p>● *X = CM - Cemento</p>	119,00 119,00		
<p><b>!</b></p> <p><b>ATTENTION: towel rail holes on request \</b> ATENCIÓN: orificios para toallero bajo pedido \ <b>ATTENTION:</b> trous porte-serviettes sur demande \ <b>ACHTUNG:</b> Löcher für Handtuchhalter auf Anfrage \ <b>ВНИМАНИЕ:</b> отверстия под полотенцедержатели ТОЛЬКО по запросу.</p> <p><b>Suspended washbasin 60 with right basin \</b> Lavabo suspendido a pared 60, seno derecha \ Lavabo suspendu 60, vasque à droite \ Hängender waschbecken 60, Becken rechts \ Раковина подвесная на стену 60, чаша справа</p> 	60 x 46 x 14 h	ERLA60DX(X)* ERLA60DXSF(X)* no tap hole sin agujero sans orifice ohne Loch без отверстия	16,00	<p>● Gloss White</p> <p>● Le Terre di Cielo</p>	485,00 702,00	20	40
<p><b>Left-hand side towel rail for the washbasin 60 \</b> Toallero izq. para lavabo 60 \ Porte-serviettes gauche pour vasque 60 \ Handtuchhalter li. für Waschbecken 60 \ Полотенцедержатели sx на раковину 60</p> 	46 x 8 x 2 h	ERPLSX(X)*	0,70	<p>● *X = NM - Matt Black</p> <p>● *X = CM - Cemento</p>	119,00 119,00		
<p><b>Structure for the washbasin 60</b> Estructura para lavabo 60 \ Structure pour vasque 60 \ Gestell für Waschbecken 60 \ Структура под раковину 60</p> <p><b>!</b> <b>framework mandatory with washbasin</b> estructura obligatoria con lavabo structure obligatoire avec évier obligatorische Struktur mit Spüle обязательная конструкция с раковиной</p> 	60 x 46 x 40 h	ERST60(X)*	6,50	<p>● *X = NM - Matt Black</p> <p>● *X = CM - Cemento</p>	619,00 619,00		
<p><b>Right- or left-hand side towel rail for the structure \</b> Toallero dcha-izq. para estructura \ Porte-serviettes droite-gauche pour structure \ Handtuchhalter re.-li. für Gestell \ Полотенцедержатели dx-sx на структуру</p> 	46 x 6,5 x 2 h	ERPLST(X)*	0,68	<p>● *X = NM - Matt Black</p> <p>● *X = CM - Cemento</p>	157,00 157,00		

## Technical symbols legend

Símbolos técnicos clave | Légende symboles techniques | Technische Zeichenerklärung | Перечень технических символов

 **without overflow**  
sin rebosadero  
sans trop-plein  
ohne Überlauf  
без слива-перелива







 **no tap hole on request**  
sin agujero, solo a petición  
sans orifice sur demande  
auf Anfrage ohne Loch  
без отверстия под смеситель по запросу

 **one side is unglazed**  
con un lado sin esmaltar  
avec un côté non émaillé  
eine Seite unglasiert  
одна сторона не покрыта эмалью



























 **with 1 hole prepared 3 holes**  
avec un trou prédisposition à trois trous  
mit 1-Loch auf 3-Loch durchschlagbar  
одно отверстие с возможностью выполнения трех отверстий

 **wall-hung installation**  
instalación suspendida  
installation suspendue  
wandhängende Montage  
подвесная установка

 **with fixing parts**  
fijaciones incluidas  
fixations incluses  
inklusive Befestigungen  
в комплекте с крепежами

 <b>ATTENTION: towel rail holes on request</b> \ ATENCIÓN: orificios para toallero bajo pedido \ ATTENTION: trous porte-serviettes sur demande \ ACHTUNG: Löcher für Handtuchhalter auf Anfrage \ ВНИМАНИЕ: отверстия под полотенцедержатели ТОЛЬКО по запросу.	<b>Size (cm)</b> Medidas Dimensions Maße Размеры	<b>Product code</b> Artículo Article Artikel Артикул	<b>Net weight (Kg)</b> Peso neto Poids net Reingewicht вес нетто	<b>Finishes</b> Acabados Finitions Farbe Отделки	<b>Euro</b> Евро	<b>Pz.</b> шт. pallet Italia	<b>Pz.</b> шт. pallet Cont.
 <p><b>Suspended washbasin 80 with left basin</b> \ Lavabo suspendido a pared 80, seno izquierda \ Lavabo suspendu 80, vasque à gauche \ Hängender waschbecken 80, Becken links \ Раковина подвесная на стену 80, чаша слева</p>	80 x 46 x 14 h	ERLA80SX(x)* ERLA80XSXF(x)* no tap hole sin agujero sans orifice ohne Loch без отверстия	21,30	● Gloss White ● Le Terre di Cielo	601,00 837,00	14	28
 <p><b>Left-hand side towel rail for the washbasin 80</b> \ Toallero izq. para lavabo 80 \ Porte-serviettes gauche pour vasque 80 \ Handtuchhalter li. für Waschbecken 80 \ Полотенцедержатели sx на раковину 80</p>	46 x 8 x 2 h	ERPLSX(x)*	0,70	● *X = NM - Matt Black ● *X = CM - Cemento	119,00 119,00		
 <p><b>Suspended washbasin 80 with right basin</b> \ Lavabo suspendido a pared 80, seno derecha \ Lavabo suspendu 80, vasque à droite \ Hängender waschbecken 80, Becken rechts \ Раковина подвесная на стену 80, чаша справа</p>	80 x 46 x 14 h	ERLA80DX(x)* ERLA80DXSF(x)* no tap hole sin agujero sans orifice ohne Loch без отверстия	21,30	● Gloss White ● Le Terre di Cielo	601,00 837,00	14	28
 <p><b>Right-hand side towel rail for the washbasin 80</b> \ Toallero dcha. para lavabo 80 \ Porte-serviettes droite pour vasque 80 \ Handtuchhalter re. für Waschbecken 80 \ Полотенцедержатели dx на раковину 80</p>	46 x 8 x 2 h	ERPLDX(x)*	0,70	● *X = NM - Matt Black ● *X = CM - Cemento	119,00 119,00		
 <p><b>Structure for the washbasin 80</b> \ Estructura para lavabo 80 \ Structure pour vasque 80 \ Gestell für Waschbecken 80 \ Структура под раковину 80</p> <p> <b>framework mandatory with washbasin</b> \ estructura obligatoria con lavabo \ structure obligatoire avec évier \ obligatorische Struktur mit Spüle \ обязательная конструкция с раковиной</p>	80 x 46 x 40h	ERST80(x)*	8,50	● *X = NM - Matt Black ● *X = CM - Cemento	669,00 669,00		
<p><b>Right- or left-hand side towel rail for the structure</b> \ Toallero dcha-izq. para estructura \ Porte-serviettes droite-gauche pour structure \ Handtuchhalter re.-li. für Gestell \ Полотенцедержатели dx-sx на структуру</p>	46 x 6,5 x 2 h	ERPLST(x)*	0,68	● *X = NM - Matt Black ● *X = CM - Cemento	157,00 157,00		

- Le Terre di Cielo
- TL - Talco
  - PM - Pomice
  - BR - Brina
  - BA - Basalto
  - LV - Lavagna
  - CM - Cemento
  - FN - Fango
  - CA - Cacao
  - AN - Arenaria
  - AV - Avena
  - LN - Lino
  - AG - Agave
  - MU - Muschio
  - PL - Polvere
  - CP - Cipria
  - CN - Canapa

	Size (cm)	Product code	Net weight (kg)	Finishes	Euro	Pz.	Pz.
	Medidas Dimensions Maße Размеры	Artículo Article Artikel Артикул	Peso neto Poids net Reingewicht вес нетто	Acabados Finitions Farbe Отделки	Евро	шт. pallet Italia	шт. pallet Cont.
<p><b>!</b></p> <p><b>ATTENTION: towel rail holes on request</b> \ ATENCIÓN: orificios para toallero bajo pedido \ ATTENTION: trous porte-serviettes sur demande \ ACHTUNG: Löcher für Handtuchhalter auf Anfrage \ ВНИМАНИЕ: отверстия под полотенцедержатели ТОЛЬКО по запросу.</p> <p>     </p> <p><b>Suspended washbasin 100 with left basin</b> \ Lavabo suspendido a pared 100, seno izquierda \ Lavabo suspendu 100, vasque à gauche \ Hängender waschbecken 100, Becken links \ Раковина подвесная на стену 100, чаша слева</p>	100 x 46 x 14 h	ERLA100SX(X)* ERLA100XSXF(X)* <b>no tap hole</b> sin agujero sans orifice ohne Loch без отверстия	25,00	 <b>Gloss White</b>  <b>Le Terre di Cielo</b>	789,00 995,00	12	24
<p></p> <p><b>Left-hand side towel rail for the washbasin 100</b> \ Toallero izq. para lavabo 100 \ Porte-serviettes gauche pour vasque 100 \ Handtuchhalter li. für Waschbecken 100 \ Полотенцедержатели sx на раковину 100</p>	46 x 8 x 2 h	ERPLSX(X)*	0,70	 *X = <b>NM - Matt Black</b>  *X = <b>CM - Cemento</b>	119,00 119,00		
<p><b>!</b></p> <p><b>ATTENTION: towel rail holes on request</b> \ ATENCIÓN: orificios para toallero bajo pedido \ ATTENTION: trous porte-serviettes sur demande \ ACHTUNG: Löcher für Handtuchhalter auf Anfrage \ ВНИМАНИЕ: отверстия под полотенцедержатели ТОЛЬКО по запросу.</p> <p>     </p> <p><b>Suspended washbasin 100 with right basin</b> \ Lavabo suspendido a pared 100, seno derecha \ Lavabo suspendu 100, vasque à droite \ Hängender waschbecken 100, Becken rechts \ Раковина подвесная на стену 100, чаша справа</p>	100 x 46 x 14 h	ERLA100DX(X)* ERLA100DXSF(X)* <b>no tap hole</b> sin agujero sans orifice ohne Loch без отверстия	25,00	 <b>Gloss White</b>  <b>Le Terre di Cielo</b>	789,00 995,00	12	24
<p></p> <p><b>Right-hand side towel rail for the washbasin 100</b> \ Toallero dcha. para lavabo 100 \ Porte-serviettes droite pour vasque 100 \ Handtuchhalter re. für Waschbecken 100 \ Полотенцедержатели dx на раковину 100</p>	46 x 8 x 2 h	ERPLDX(X)*	0,70	 *X = <b>NM - Matt Black</b>  *X = <b>CM - Cemento</b>	119,00 119,00		
<p></p> <p><b>Structure for the washbasin 100</b> \ Estructura para lavabo 100 \ Structure pour vasque 100 \ Gestell für Waschbecken 100 \ Структура под раковину 100</p> <p><b>!</b></p> <p><b>framework mandatory with washbasin</b> estructura obligatoria con lavabo structure obligatoire avec évier obligatorische Struktur mit Spüle обязательная конструкция с раковиной</p>	100 x 46 x 40 h	ERST100(X)*	8,50	 *X = <b>NM - Matt Black</b>  *X = <b>CM - Cemento</b>	746,00 746,00		
<p><b>Right- or left-hand side towel rail for the structure</b> \ Toallero dcha-izq. para estructura \ Porte-serviettes droite-gauche pour structure \ Handtuchhalter re.-li. für Gestell \ Полотенцедержатели dx-sx на структуру</p>	46 x 6,5 x 2 h	ERPLST(X)*	0,68	 *X = <b>NM - Matt Black</b>  *X = <b>CM - Cemento</b>	157,00 157,00		

## Technical symbols legend

Símbolos técnicos clave / Légende symboles techniques / Technische Zeichenerklärung / Перечень технических символов



**without overflow**  
sin rebosadero  
sans trop-plein  
ohne Überlauf  
без слива-перелива



**no tap hole on request**  
sin agujero, solo a petición  
sans orifice sur demande  
auf Anfrage ohne Loch  
без отверстия под  
смеситель по запросу



**one side is unglazed**  
con un lado sin esmaltar  
avec un côté non émaillé  
eine Seite unglasiert  
одна сторона не покрыта  
эмалью



**with 1 hole prepared 3 holes**  
avec un trou prédisposition à trois trous  
mit 1-Loch auf 3-Loch durchschlagbar  
одно отверстие с возможностью  
выполнения трех отверстий



**wall-hung installation**  
instalación suspendida  
installation suspendue  
wandhängende Montage  
подвесная установка



**with fixing parts**  
fijaciones incluidas  
fixations incluses  
inklusive Befestigungen  
в комплекте с крепежами



























	Size (cm) Medidas Dimensions Maße Размеры	Product code Artículo Article Artikel Артикул	Net weight(Kg) Peso neto Poids net Reingewicht вес нетто	Finishes Acabados Finitions Farbe Отделки	Euro Евро	Pz. шт. pallet Italia	Pz. шт. pallet Cont.
  <p><b>Oval on top bowl Eco 62</b> Cubela de apoio Eco oval 62 Vasque à poser Eco ovale 62 Aufsatzbecken Oval Eco 62 Раковина овальный Eco 62</p>	62 x 45 x 18 h	BAECO(X)*	10,50	<ul style="list-style-type: none"> <li> Gloss White</li> <li> Le Terre di Cielo</li> <li> Le Acque di Cielo</li> </ul>	601,00 840,00 840,00	14	28
  <p><b>Eco Small on top bowl</b> Cubela de apoio Eco Small Vasque à poser Eco Small Aufsatzbecken Runde Eco Small Раковина круглый Eco Small</p>	58 x 42 x 16,5 h	BAEC058(X)*	10,00	<ul style="list-style-type: none"> <li> Gloss White</li> <li> Le Terre di Cielo</li> <li> Le Acque di Cielo</li> </ul>	534,00 788,00 788,00	16	32
  <p><b>Round on top bowl Era ø45</b> Cubela de apoio Era ronda ø45 Vasque à poser Era tour ø45 Aufsatzbecken Runde Era ø45 Раковина круглый Era ø45</p>	ø45 x 24 h	BAERA(X)*	13,00	<ul style="list-style-type: none"> <li> Gloss White</li> <li> Le Terre di Cielo</li> <li> Le Acque di Cielo</li> </ul>	667,00 934,00 934,00	16	32
  <p><b>Era Small on top bowl</b> Cubela de apoio Era Small Vasque à poser Era Small Aufsatzbecken Runde Era Small Раковина круглый Era Small</p>	ø40 x 15 h	BAERA40(X)*	8,00	<ul style="list-style-type: none"> <li> Gloss White</li> <li> Le Terre di Cielo</li> <li> Le Acque di Cielo</li> </ul>	424,00 690,00 690,00	26	52
  <p><b>Handy round on top bowl with one hole</b> Lavabo Handy ronda con 1 agujero ø45 Lavabo Handy tour tour monotrou ø45 Aufsatzbecken Runde Handy ø45 1-Loch Раковина круглый Handy ø45 одно отверстие под смеситель</p>	45 x 17 h	HALAT45(X)* HALAT45SF(X)* no tap hole sin agujero sans orifice ohne Loch без отверстия	10,50	<ul style="list-style-type: none"> <li> Gloss White</li> <li> Le Terre di Cielo</li> <li> Le Acque di Cielo</li> </ul>	456,00 714,00 714,00	20	34

## Technical symbols legend

Símbolos técnicos clave | Légende symboles techniques | Technische Zeichenerklärung | Перечень технических символов

 all sides are enamelled con todos los lados esmaltados avec tous les côtés émaillés alle Seiten glasiert все стороны покрыты эмалью	 no tap holes sin agujero para grifo sans orifice robinet ohne Hahnloch без отверстия под смеситель	 one tap hole con 1 agujero monotrou 1-Loch одно отверстие под смеситель	 no tap hole on request sin agujero, solo a petición sans orifice sur demande auf Anfrage ohne Loch без отверстия под смеситель по запросу	 with overflow con rebosadero avec trop-plein mit Überlauf с переливом	 without overflow sin rebosadero sans trop-plein ohne Überlauf без слива-перелива	 on top installation instalación de apoyo installation à partir du plan Montage auf Platte установка на столешницу
--	--	---	---	---	--	---

	Product code Artículo Article Artikel Артикул	Net weight <sub>(Kg)</sub> Peso neto Poids net Reingewicht вес нетто	Finishes Acabados Finitions Farbe Отделка	Euro Евро
 <p><b>Universal click/clack drain in CHROME with ceramic lid</b> Válvula universal click/clack Cromado con tapa en cerámica Bonde universelle clic/clac Chromé avec clapet en céramique Universal-Abflussgarnitur Click-Clack Chrom mit Keramikstopfen Универсальный донный клапан click/clack хром с керамической крышкой</p>	PIL01(X)*	0,40	 <b>Gloss White</b>	<b>95,00</b>
			 <b>Le Terre di Cielo</b>	<b>139,00</b>
			 <b>Le Acque di Cielo</b>	<b>139,00</b>
 <p><b>Universal click/clack drain in BLACK MATT finish with ceramic lid</b> Válvula universal click/clack Negro Matt con tapa en cerámica Bonde universelle clic/clac Noir Mat avec clapet en céramique Universal-Abflussgarnitur Click-Clack Matt Schwarz mit Keramikstopfen Универсальный донный клапан click/clack черный матовый с керамической крышкой</p>	PIL01NM(X)*	0,40	 <b>Gloss White</b>	<b>120,00</b>
			 <b>Le Terre di Cielo</b>	<b>169,00</b>
			 <b>Le Acque di Cielo</b>	<b>169,00</b>
 <p><b>Universal click/clack drain in CEMENTO finish with ceramic lid</b> Válvula universal click/clack Cemento con tapa en cerámica Bonde universelle clic/clac Cemento avec clapet en céramique Universal-Abflussgarnitur Click-Clack Cement mit Keramikstopfen Универсальный донный Cemento click/clack с керамической крышкой</p>	PIL01CM(X)*	0,40	 <b>Gloss White</b>	<b>120,00</b>
			 <b>Le Terre di Cielo</b>	<b>169,00</b>
			 <b>Le Acque di Cielo</b>	<b>169,00</b>
 <p><b>Universal click/clack drain in BRONZE with ceramic lid</b> Válvula universal click/clack Bronce con tapa en cerámica Bonde universelle clic/clac Bronze avec clapet en céramique Universal-Abflussgarnitur Click-Clack Bronze mit Keramikstopfen Универсальный донный клапан click/clack бронза с керамической крышкой</p>	PIL01BR(X)*	0,40	 <b>Gloss White</b>	<b>135,00</b>
			 <b>Le Terre di Cielo</b>	<b>182,00</b>
			 <b>Le Acque di Cielo</b>	<b>182,00</b>
 <p><b>CHROMED siphon</b> Sifone Cromado \ Siphon Chromé \ Siphon Verchromt \ сифон Chrome</p>	SISP	0,93	 <b>Chrome</b>	<b>133,00</b>
 <p><b>MATT BLACK siphon</b> Sifone Negro Mate \ Siphon Noir Mat \ Siphon Schwarz Matt \ Сифон Черный матовый</p>	SIFN	0,93	 <b>Matt Black</b>	<b>194,00</b>
 <p><b>CEMENTO siphon</b> Sifone Cemento \ Siphon Cemento \ Siphon Cemento \ сифон Cemento</p>	SIFCM	0,93	 <b>Cemento</b>	<b>194,00</b>
 <p><b>BRONZE siphon</b> Sifone Bronce \ Siphon Bronze \ Siphon Bronze \ бронза сифон</p>	SIFBR	0,93	 <b>Bronze</b>	<b>220,00</b>

Le Terre di Cielo	 TL - Talco	 PM - Pomice	 BR - Brina	 BA - Basalto	 LV - Lavagna	 CM - Cemento	 FN - Fango	 CA - Cacao
	 AN - Arenaria	 AV - Avena	 LN - Lino	 AG - Agave	 MU - Muschio	 PL - Polvere	 CP - Cipria	 CN - Canapa
Le Acque di Cielo	 OL - Oltremare	 SM - Smeraldo	 AL - Alga	 CO - Corallo	 NI - Ninfea	 AM - Anemone		



## CIELO RIMLESS 2.0.1®

**Wall-hung wc with fixing kit  
(4,5 LT) - rimless 2.0.1**

Inodoro suspendido completo con fijaciones (4,5 LT) - sin brida - rimless 2.0.1 \ Cuvette suspendue avec fixations (4,5 LT) - sans bride - rimless 2.0.1 \ Wand-WC mit Befestigungsset (4,5 Lt.) - ohne Spülrand - rimless 2.0.1  
Подвесной унитаз в комплекте с крепежами (4,5 литр) - без ободка - rimless 2.0.1

**Size (cm)**

Medidas  
Dimensions  
Maße  
Размеры

36,5 x 53 x  
37 h

**Product code**

Artículo  
Article  
Artikel  
Артикул

ERVSK(X)\*

**Net weight(Kg)**

Peso neto  
Poids net  
Reingewicht  
вес нетто

22,60

**Finishes**

Acabados  
Finitions  
Farbe  
Отделка

- Gloss White
- \*X = TL - Talco
- Le Terre di Cielo \*
- Le Acque di Cielo

**Euro**

Евро

482,00  
728,00  
770,00  
770,00

**Pz.**

шт.  
pallet  
Italia

18

**Pz.**

шт.  
pallet  
Cont.

18

**QUICK RELEASE HINGES**

**Thermosetting seat & cover**

Asiento para inodoro  
Abattant thermodurcissable  
Wc-sitz thermodur  
Сиденье из термоотверждающейся смолы

CPVERT

2,50

- Gloss White

110,00

**QUICK RELEASE HINGES**

**Thermosetting soft close seat & cover**

Asiento para inodoro amortiguado  
Abattant thermodurcissable soft  
Wc-sitz thermodur mit Abs.  
Сиденье из термоотверждающейся смолы с плавным опусканием

CPVERTF(X)\*

2,50

- Gloss White
- \*X = TL - Talco
- Le Terre di Cielo #
- Le Acque di Cielo

188,00  
296,00  
316,00  
316,00

**Impact and acoustic protection**

**panel** Protección antigolpes y acústica /  
Protection acoustique et anti-choc / Stoss-  
und Schalldämmung / Противоударная и  
акустическая защита

PAA

0,16

17,00

**Couple of fixing brackets for  
wall-hung wc/bidet**

Pareja de estribo para Inodoro/Bidet  
suspendido / Étriers de fixation pour Wc/  
Bidet suspendus / 1 Paar Halterungen für  
wandhängendes Wc/Bidet / Монтажная рама  
для подвесного унитаза/биде

3,3 x 18,5 x  
55 h

508

2,00

39,00

**Technical symbols legend**

Símbolos técnicos clave | Légende symboles techniques | Technische Zeichenerklärung | Перечень технических символов









<p><b>wall-hung installation</b> instalación suspendida installation suspendue wandhängende Montage подвесная установка</p>	<p><b>with fixing parts</b> fijaciones incluidas fixations incluses inklusive Befestigungen в комплекте с крепежами</p>	<p><b>4,5 l toilet tank</b> descarga 4,5 lt évacuation à 4,5 l 4,5-L-Spülung бачок на 4,5 л</p>	<p><b>Combifix compatibility</b> compatible Combifix mit Combifix kompatibel совместим с combifix</p>	<p><b>quick release hinge</b> sistema extraíble charnières à ouverture Takeoff Funktion Быстрый съем</p>
---	---	---	---	--

\* Acque di Cielo finishes available for wc-bidet /  
Acabados Acque di Cielo disponibles para wc-bidet / Finitions Acque  
di Cielo disponibles pour cuvette-bidet / Für das WC/Bidet erhältliche  
Ausführungen Acque di Cielo / Отделка Acque di Cielo доступны  
для унитаза и биде

OL - Oltremare  SM - Smeraldo  AL - Alga  CO - Corallo  NI - Ninfea  AM - Anemone





\* Terre di Cielo finishes available for wc-bidet /  
Acabados Terre di Cielo disponibles para wc-bidet / Finitions Terre di  
Cielo disponibles pour cuvette-bidet / Für das WC/Bidet erhältliche  
Ausführungen Terre di Cielo / Отделка Terre di Cielo доступны для  
унитаза и биде

TL - Talco  PM - Pomice  BR - Brina  AN - Arenaria  AV - Avena  CM - Cemento  BA - Basalto  LV - Lavagna

	 <b>Size (cm)</b> Medidas Dimensions Maße Размеры	<b>Product code</b> Artículo Article Artikel Артикул	<b>Net weight(Kg)</b> Peso neto Poids net Reingewicht вес нетто	<b>Finishes</b> Acabados Finitions Farbe Отделки	<b>Euro</b> Евро	<b>Pz.</b> шт. pallet Italia	<b>Pz.</b> шт. pallet Cont.
<b>Wall-hung one hole bidet with fixing kit</b> Bidé suspendu monoagujero completo con fijaciones / Bidet suspendu monotrou avec fixation / Wand-Bidet einloch mit Befestigungsset / Биде подвесное с одним отверстием под смеситель, в комплекте с крепежами	36,5 x 53 x 30 h	ERBS(X)*	20,00	● Gloss White ● *X = TL - Talco ● Le Terre di Cielo * ● Le Acque di Cielo	436,00 691,00 746,00 746,00	18	18
 <b>Impact and acoustic protection panel</b> / Protección antigolpes y acústica / Protection acoustique et anti-choc / Stoss- und Schalldämmung / Противоударная и акустическая защита		PAA	0,16		17,00		
 <b>Couple of fixing brackets for wall-hung wc/bidet</b> - Pareja de estribo para Inodoro/Bidet suspendido / Étriers de fixation pour Wc/Bidet suspendus / 1 Paar Halterungen für wandhängendes Wc/Bidet / Монтажная рама для подвесного унитаза/биде	3,3 x 18,5 x 55 h	508	2,00		39,00		
 <b>Universal click/clack drain in CHROME with ceramic lid</b> Válvula universal click/clack Cromado con tapa en cerámica Bonde universelle clic/clac Chromé avec clapet en céramique Universal-Abflussgarnitur Click-Clack Chrom mit Keramikstopfen Универсальный донный клапан click/clack хром с керамической крышкой		PIL01(X)*	0,40	● Gloss White ● Le Terre di Cielo ● Le Acque di Cielo	95,00 139,00 139,00		
 <b>Universal click/clack drain in BLACK MATT finish with ceramic lid</b> Válvula universal click/clack Negro Matt con tapa en cerámica Bonde universelle clic/clac Noir Mat avec clapet en céramique Universal-Abflussgarnitur Click-Clack Matt Schwarz mit Keramikstopfen Универсальный донный клапан click/clack черный матовый с керамической крышкой		PIL01NM(X)*	0,40	● Gloss White ● Le Terre di Cielo ● Le Acque di Cielo	120,00 169,00 169,00		
 <b>Universal click/clack drain in CEMENTO finish with ceramic lid</b> Válvula universal click/clack Cemento con tapa en cerámica Bonde universelle clic/clac Cemento avec clapet en céramique Universal-Abflussgarnitur Click-Clack Cement mit Keramikstopfen Универсальный донный Cemento click/clack с керамической крышкой		PIL01CM(X)*	0,40	● Gloss White ● Le Terre di Cielo ● Le Acque di Cielo	120,00 169,00 169,00		
 <b>Universal click/clack drain in BRONZE with ceramic lid</b> Válvula universal click/clack Bronce con tapa en cerámica Bonde universelle clic/clac Bronze avec clapet en céramique Universal-Abflussgarnitur Click-Clack Bronze mit Keramikstopfen Универсальный донный клапан click/clack бронза с керамической крышкой		PIL01BR(X)*	0,40	● Gloss White ● Le Terre di Cielo ● Le Acque di Cielo	135,00 182,00 182,00		

#### Technical symbols legend

Símbolos técnicos clave / Légende symboles techniques / Technische Zeichenerklärung / Перечень технических символов

 <b>with overflow</b> con rebosadero avec trop-plein mit Überlauf с переливом	 <b>one tap hole</b> con 1 agujero monotrou 1-Loch одно отверстие под смеситель	 <b>wall-hung installation</b> instalación suspendida installation suspendue wandhängende Montage подвесная установка	 <b>with fixing parts</b> fijaciones incluidas fixations incluses fixationen inklusive в комплекте с крепежами	 <b>Combifix compatibility</b> compatible Combifix mit Combifix kompatibel совместим с combifix
---	---	--	---	---

#### \* Acque di Cielo finishes available for wc-bidet /

Acabados Acque di Cielo disponibles para wc-bidet / Finitions Acque di Cielo disponibles pour cuvette-bidet / Für das WC/Bidet erhältliche Ausführungen Acque di Cielo / отделки Acque di Cielo доступны для унитаза и биде















● OL - Oltremare ● SM - Smeraldo ● AL - Alga ● CO - Corallo ● NI - Ninfea ● AM - Anemone

#### \* Terre di Cielo finishes available for wc-bidet /

Acabados Terre di Cielo disponibles para wc-bidet / Finitions Terre di Cielo disponibles pour cuvette-bidet / Für das WC/Bidet erhältliche Ausführungen Terre di Cielo / отделки Terre di Cielo доступны для унитаза и биде





● TL - Talco ● PM - Pomice ● BR - Brina ● AN - Arenaria ● AV - Avena ● CM - Cemento ● BA - Basalto ● LV - Lavagna

CIELO  
RIMLESS 2.0.1®

	Size (cm)	Product code	Net weight (Kg)	Finishes	Euro	Pz.	Pz.
	Medidas Dimensions Maße Размеры	Artículo Article Artikel Артикул	Peso neto Poids net Reingewicht вес нетто	Acabados Finitions Farbe Отделки	Евро	шт. pallet Italia	шт. pallet Cont.
 <p><b>Wc with horizontal outlet convertible to floor outlet by technical curve (4,5 LT) - rimless 2.0.1</b> Wc con desagüe a pared convertible a suelo con curva técnica (4,5 LT) - sin brida - rimless 2.0.1 Wc avec évacuation murale transformable à terre avec courbe technique (4,5l) - sans bride - rimless 2.0.1 WC mit Wandabfluss, durch Kurventechnik auf Bodenabfluss umrüstbar (4,5 LT) - ohne Spülrand - rimless 2.0.1 \ Слив в стену при помощи технического колена трансформируется на слив в пол (4,5 л) - без ободка - rimless 2.0.1</p>	36,5 x 52 x 42 h	ERVAK(X)*	29,20	<ul style="list-style-type: none"> <li> Gloss White</li> <li> *X = TL - Talco</li> <li> Le Terre di Cielo *</li> <li> Le Acque di Cielo</li> </ul>	482,00 728,00 770,00 770,00	15	20
 <p><b>Thermosetting seat &amp; cover</b> Asiento para inodoro Abattant thermdurcissable Wc-sitz thermotur Сиденье из термоотверждающейся смолы</p>		CPVERT	2,50	<ul style="list-style-type: none"> <li> Gloss White</li> </ul>	110,00		
 <p><b>Thermosetting soft close seat &amp; cover</b> Asiento para inodoro amortiguado Abattant thermdurcissable soft Wc-sitz thermotur mit Abs. Сиденье из термоотверждающейся смолы с плавным опусканием</p>		CPVERTF(X)*	2,50	<ul style="list-style-type: none"> <li> Gloss White</li> <li> *X = TL - Talco</li> <li> Le Terre di Cielo *</li> <li> Le Acque di Cielo</li> </ul>	188,00 296,00 316,00 316,00		
 <p><b>Technical curve "floor trap" for toilet</b> Curva técnica "salida vertical" para inodoro Courbe technique à S pour cuvette avec sortie au sol WC-Ablaufbogen "S" Колено "S"-образное для унитазов, регулируемое</p>		CSB	0,40		18,00		
 <p><b>Straight pan connector for wall trap</b> Anclaje a pared para inodoro Pipe pour sortie horizontale WC-Anschlussstutzen für Abgang waagrecht Фитинг для выпуска в стену для унитазов</p>		RPB	0,35		15,00		

## Technical symbols legend

Símbolos técnicos clave | Légende symboles techniques | Technische Zeichenerklärung | Перечень технических символов

 back to wall installation instalación a suelo installation à terre bodenstehende Montage напольная установка	 with fixing parts fijaciones incluidas inclusions incluses inklusive Befestigungen в комплекте с крепежами	 4,5 l toilet tank descarga 4,5 lt évacuation à 4,5 l 4,5 l-Spülung бачок на 4,5 л	 bifunctional drain descarga bifuncional évacuation bifonctionnelle Spülung mit zwei Montagevarianten функциональный бачок	 quick release hinge sistema extraíble charnières à ouverture Takeoff Funktion быстрый сьем
---	--	---	--	--

## \* Acque di Cielo finishes available for wc-bidet /























Acabados Acque di Cielo disponibles para wc-bidet / Finitions Acque di Cielo disponibles pour cuvette-bidet / Für das WC/Bidet erhältliche Ausführungen Acque di Cielo / отделки Acque di Cielo доступны для унитаза и биде

-  OL - Oltremare
-  SM - Smeraldo
-  AL - Alga
-  CO - Corallo
-  NI - Ninfea
-  AM - Anemone

## \* Terre di Cielo finishes available for wc-bidet /

Acabados Terre di Cielo disponibles para wc-bidet / Finitions Terre di Cielo disponibles pour cuvette-bidet / Für das WC/Bidet erhältliche Ausführungen Terre di Cielo / отделки Terre di Cielo доступны для унитаза и биде

-  TL - Talco
-  PM - Pomice
-  BR - Brina
-  AN - Arenaria
-  AV - Avena
-  CM - Cemento
-  BA - Basalto
-  LV - Lavagna

		Size (cm)	Product code	Net weight(Kg)	Finishes	Euro	Pz.	Pz.
		Medidas Dimensions Maße Размеры	Artículo Article Artikel Артикул	Peso neto Poids net Reingewicht вес нетто	Acabados Finitions Farbe Отделка	Евро	шт. pallet Italia	шт. pallet Cont.
 <p><b>Back to wall one hole bidet</b>                      Bidé a suelo monoaquero                      Bidet monotrou                      Stand-Bidet einloch                      Биде напольное с одним отверстием под смеситель</p>		36,5 x 52 x 42 h	ERBI(X)*	26,00	<ul style="list-style-type: none"> <li> <b>Gloss White</b></li> <li> *X = TL - Talco</li> <li> <b>Le Terre di Cielo *</b></li> <li> <b>Le Acque di Cielo</b></li> </ul>	424,00 667,00 741,00 741,00	15	20
 <p><b>Universal click/clack drain in CHROME with ceramic lid</b>                      Válvula universal click/clack Cromado con tapa en cerámica                      Bonde universelle clic/clac Chromé avec clapet en céramique                      Universal-Abflussgarnitur Click-Clack Chrom mit Keramikstopfen                      Универсальный донный клапан click/clack хром с керамической крышкой</p>			PIL01(X)*	0,40	<ul style="list-style-type: none"> <li> <b>Gloss White</b></li> <li> <b>Le Terre di Cielo</b></li> <li> <b>Le Acque di Cielo</b></li> </ul>	95,00 139,00 139,00		
 <p><b>Universal click/clack drain in BLACK MATT finish with ceramic lid</b>                      Válvula universal click/clack Negro Matt con tapa en cerámica                      Bonde universelle clic/clac Noir Mat avec clapet en céramique                      Universal-Abflussgarnitur Click-Clack Matt Schwarz mit Keramikstopfen                      Универсальный донный клапан click/clack черный матовый с керамической крышкой</p>			PIL01NM(X)*	0,40	<ul style="list-style-type: none"> <li> <b>Gloss White</b></li> <li> <b>Le Terre di Cielo</b></li> <li> <b>Le Acque di Cielo</b></li> </ul>	120,00 169,00 169,00		
 <p><b>Universal click/clack drain in CEMENTO finish with ceramic lid</b>                      Válvula universal click/clack Cemento con tapa en cerámica                      Bonde universelle clic/clac Cemento avec clapet en céramique                      Universal-Abflussgarnitur Click-Clack Cement mit Keramikstopfen                      Универсальный донный Cemento click/clack с керамической крышкой</p>			PIL01CM(X)*	0,40	<ul style="list-style-type: none"> <li> <b>Gloss White</b></li> <li> <b>Le Terre di Cielo</b></li> <li> <b>Le Acque di Cielo</b></li> </ul>	120,00 169,00 169,00		
 <p><b>Universal click/clack drain in BRONZE with ceramic lid</b>                      Válvula universal click/clack Bronze con tapa en cerámica                      Bonde universelle clic/clac Bronze avec clapet en céramique                      Universal-Abflussgarnitur Click-Clack Bronze mit Keramikstopfen                      Универсальный донный клапан click/clack бронза с керамической крышкой</p>			PIL01BR(X)*	0,40	<ul style="list-style-type: none"> <li> <b>Gloss White</b></li> <li> <b>Le Terre di Cielo</b></li> <li> <b>Le Acque di Cielo</b></li> </ul>	135,00 182,00 182,00		

## Technical symbols legend

Simbolos técnicos clave | Légende symboles techniques | Technische Zeichenerklärung | Перечень технических символов

 <p><b>one tap hole</b>                      con 1 agujero                      monotrou                      1-Loch                      одно отверстие под смеситель</p>	 <p><b>with overflow</b>                      con rebosadero                      avec trop-plein                      mit Überlauf                      с переливом</p>	 <p><b>back to wall installation</b>                      instalación a suelo                      installation à terre                      bodenstehende Montage                      напольная установка</p>	 <p><b>with fixing parts</b>                      fijaciones incluidas                      fixations incluses                      inklusive Befestigungen                      в комплекте с крепежами</p>
--	---	--	---

\* Acque di Cielo finishes available for wc-bidet /  
 Acabados Acque di Cielo disponibles para wc-bidet | Finitions Acque di Cielo disponibles pour cuvette-bidet | Für das WC/Bidet erhältliche Ausführungen Acque di Cielo | отделки Acque di Cielo доступны для унитаза и биде

 OL - Oltremare  SM - Smeraldo  AL - Alga  CO - Corallo  NI - Ninfea  AM - Anemone

\* Terre di Cielo finishes available for wc-bidet /  
 Acabados Terre di Cielo disponibles para wc-bidet | Finitions Terre di Cielo disponibles pour cuvette-bidet | Für das WC/Bidet erhältliche Ausführungen Terre di Cielo | отделки Terre di Cielo доступны для унитаза и биде

 TL - Talco  PM - Pomice  BR - Brina  AN - Arenaria  AV - Avena  CM - Cemento  BA - Basalto  LV - Lavagna



## Wall-hung urinal

Urinario suspendido \ Urinoir suspendu  
Wand-Urinal \ писсуар подвесной



## Fixing, dispensing and siphon kit for urinal Era (mandatory)

Kit montaje/entrega/sifón urinario Era (obligatorio)  
Accessoires de fixation, chasse et siphon pour urinoir Era (nécessaire) / Befestigungen und Ablaufschlauch Set für Urinal Era (geböten) / Комплект для крепления/подачи воды в писсуар (обязательный)

Size (cm)	Product code	Net weight (Kg)	Finishes	Euro	Pz.	Pz.
Medidas Dimensions Maße Размеры	Artículo Article Artikel Артикул	Peso neto Poids net Reingewicht вес нетто	Acabados Finitions Farbe Отделки	Евро	шт. pallet Italia	шт. pallet Cont.
33,5 x 27 x 63h	EROR(X)*		<ul style="list-style-type: none"> <li><span style="display: inline-block; width: 10px; height: 10px; background-color: white; border: 1px solid black; border-radius: 50%; margin-right: 5px;"></span> Gloss White</li> <li><span style="display: inline-block; width: 10px; height: 10px; background-color: #808080; border: 1px solid black; border-radius: 50%; margin-right: 5px;"></span> Le Terre di Cielo</li> </ul>	613,00 855,00	16	32
	ORKITER(X)*		<ul style="list-style-type: none"> <li><span style="display: inline-block; width: 10px; height: 10px; background-color: white; border: 1px solid black; border-radius: 50%; margin-right: 5px;"></span> *X = B - White</li> </ul>	130,00		



## N.B. The flush mechanism is not included

El kit no incluye el mecanismo de descarga / Le kit ne comprend pas le mécanisme de chasse d'eau / Achtung: Der Spülmechanismus ist im Set nicht enthalten / Примечание: сливной механизм в комплект не входит

## Technical symbols legend

Símbolos técnicos clave | Légende symboles techniques | Technische Zeichenerklärung | Перечень технических символов

wall-hung installation  
instalación suspendida  
installation suspendue  
wandhängende Montage  
подвесная установка

one side is unglazed  
con un lado sin esmaltar  
avec un côté non émaillé  
eine Seite unglasiert  
одна сторона не покрыта эмалью

Le Terre di Cielo  TL - Talco  PM - Pomice  BR - Brina  BA - Basalto  LV - Lavagna  CM - Cemento  FN - Fango  CA - Cacao  
 AN - Arenaria  AV - Avena  LN - Lino  AG - Agave  MU - Muschio  PL - Polvere  CP - Cipria  CN - Canapa







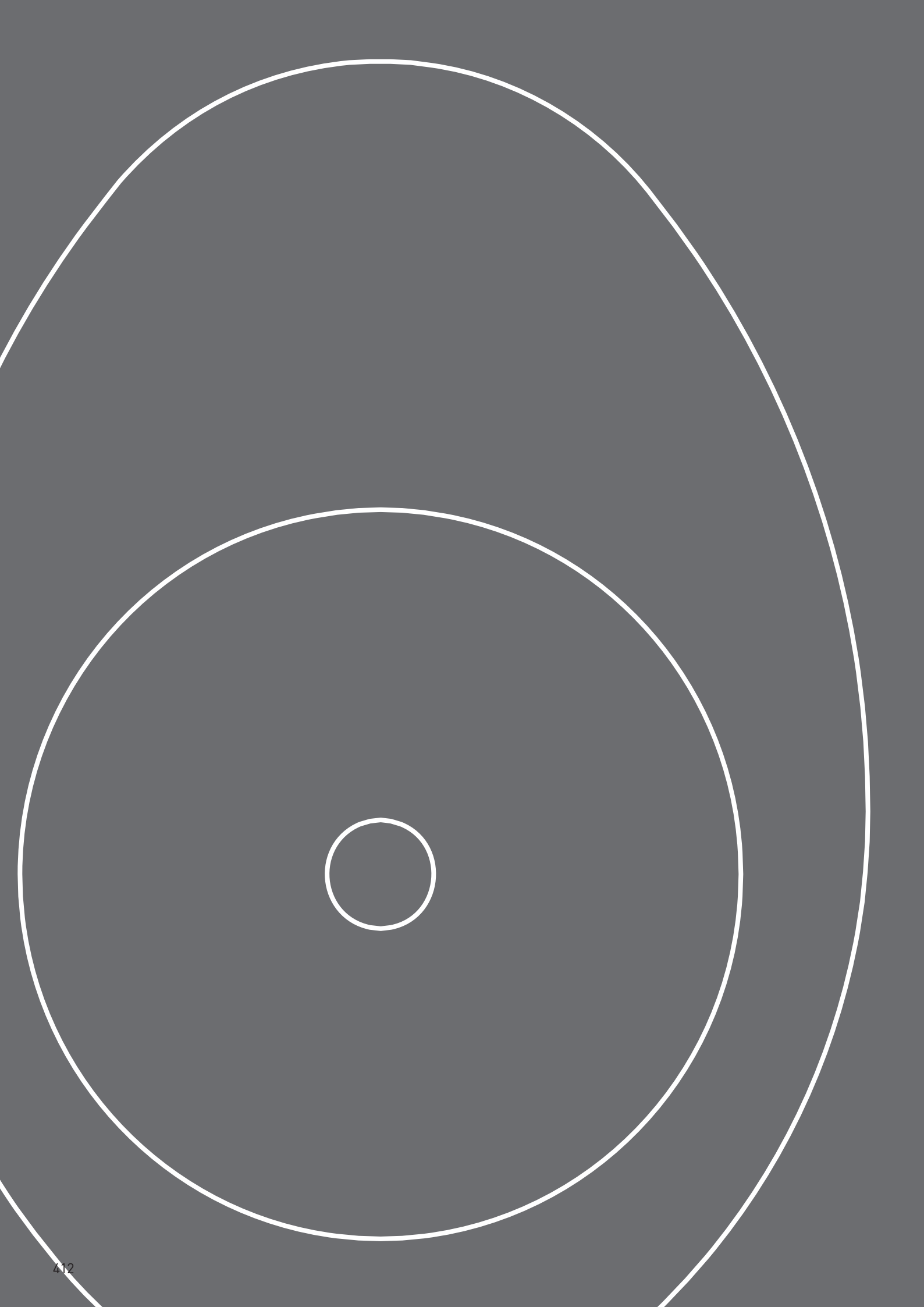

# Le Giare

design Claudio Silvestrin

indice collezione \ collection pg. 417

listino prezzi \ price list pg. 418 - 425







## Washbasins finishes

Acabados de Lavabos  
Finitions des Lavabos  
Waschbecken Farbe  
Отделки Раковина

-  Gloss White
-  N - Gloss Black



## WC and Bidets finishes

Acabados de Sanitarios  
Finitions des WC et Bidets  
WC und Bidet Farbe  
Отделки Унитаз и Биде

-  Gloss White
-  N - Gloss Black  
(LGVS - LGBSREV)
-  TL - Talco  
(LGVS - LGBSREV)

## Bath tub finishes

Acabados de la Bañadera  
Finitions de la Baignoire  
Badewanne Farbe  
Отделки ванна

-  Matt White
-  Brina
-  Arenaria

## Le Terre di Cielo

-  TL - Talco
-  PM - Pomice
-  BR - Brina
-  CM - Cemento
-  BA - Basalto
-  LV - Lavagna
-  FN - Fango
-  CA - Cacao
-  AN - Arenaria
-  AV - Avena
-  MU - Muschio
-  AG - Agave
-  LN - Lino
-  CN - Canapa
-  CP - Cipria
-  PL - Polvere





## Le Terre di Cielo

(LGVS - LGBSREV)

-  PM - Pomice
-  BR - Brina
-  AV - Avena
-  AN - Arenaria
-  CM - Cemento
-  BA - Basalto
-  LV - Lavagna

## Le Pietre

(LGLA60)

-  CS - Carrara Statuario
-  BC - Breccia Arabescata
-  GS - Grey Stone
-  BP - Breccia Paradiso
-  NQ - Nero Marquina

The possible variations of the colour cannot be considered as defect, but as a guarantee of the completely artisan manufacturing of this unique and high quality product.

Las variaciones de colores no se consideran un defecto sino una garantía de una elaboración manual y artesanal en un producto único y de calidad.

Les éventuelles variations de couleur ne peuvent être considérées comme des défauts, elles témoignent en revanche d'une méthode de travail totalement manuelle et artisanale employée pour obtenir un produit fini unique et de qualité.

Eventuelle Farbvariationen sind nicht als Mangel anzusehen, sondern als Garantie für die komplett handwerkliche Anfertigung eines einzigartigen und hochqualitativen Produkts.

Возможные вариации цвета не могут считаться дефектом, а являются подтверждением ручной работы, гарантией качества и уникальности изделия.

## Lavabi / washbasins

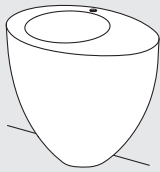

**LGFREE**  
88 x 63 x 83 h  
pag. 418

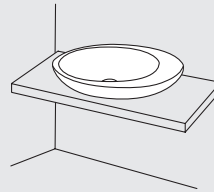

**LGLA60**  
60 x 45 x 14,5 h  
pag. 420

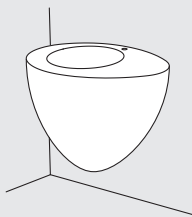

**LGLS70**  
70 x 56 x 59 h  
pag. 419

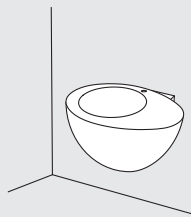

**LGLS56**  
56 x 45 x 35 h  
pag. 419

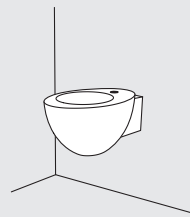

**LGLS**  
34 x 50 x 30 h  
pag. 420

## Wc - bidet



**LGVS**  
37 x 55 x 37,5 h  
pag. 422



**LGBSREV**  
37 x 55 x 33,5 h  
pag. 423

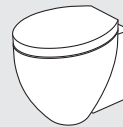

**LGVA**  
37 x 55 x 42,5 h  
pag. 424



**LGBIREV**  
37 x 55 x 42,5 h  
pag. 425

## Bath tub \_Baignoire\_Badewanne\_ванна

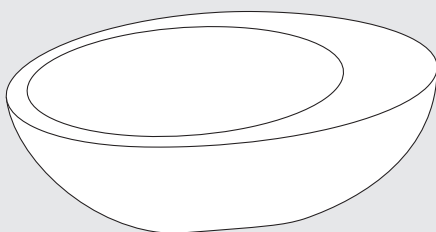

**LGBAT**  
190 x 119 x 60 h  
pag. 420

## Specchio / mirror







**LGSP**  
62 x 2,5 x 87 h  
pag. 420





## Freestanding washbasin back to wall installation

Lavabo freestanding instalaci3n a pared  
Lavabo sur pied à installer au mur  
Freistehender Säulenwaschtisch Montage an der Wand  
Раковина отдельностоящая, пристенная установка

Size (cm)	Product code	Net weight (Kg)	Finishes	Euro	Pz.	Pz.
Medidas Dimensions Maße Размеры	Artículo Article Artikel Артикул	Peso neto Poids net Reingewicht вес нетто	Acabados Finitions Farbe Отделка	Евро	шт. pallet Italia	шт. pallet Cont.
88 x 63 x 83 h	LGFREE(X)* LGFREESF(X)* no tap hole sin agujero - sans orifice - ohne Loch без отверстия	56,50	<ul style="list-style-type: none"> <li><span style="display: inline-block; width: 10px; height: 10px; border: 1px solid black; border-radius: 50%; background-color: white; margin-right: 5px;"></span> Gloss White</li> <li><span style="display: inline-block; width: 10px; height: 10px; border: 1px solid black; border-radius: 50%; background-color: black; margin-right: 5px;"></span> *X = N - Gloss Black</li> <li><span style="display: inline-block; width: 10px; height: 10px; border: 1px solid black; border-radius: 50%; background-color: #8B4513; margin-right: 5px;"></span> Le Terre di Cielo</li> </ul>	3606,00 5019,00 5749,00	1	2
	SIFR	0,51		76,00		
	LGFI	2,00		126,00		
 <b>Universal click/clack drain in CHROME with ceramic lid</b> Válvula universal click/clack Cromado con tapa en cerámica Bonde universelle clic/clac Chromé avec clapet en céramique Universal-Abflussgarnitur Click-Clack Chrom mit Keramikstopfen Универсальный донный клапан click/clack хром с керамической крышкой	PIL01(X)*	0,40	<ul style="list-style-type: none"> <li><span style="display: inline-block; width: 10px; height: 10px; border: 1px solid black; border-radius: 50%; background-color: white; margin-right: 5px;"></span> Gloss White</li> <li><span style="display: inline-block; width: 10px; height: 10px; border: 1px solid black; border-radius: 50%; background-color: black; margin-right: 5px;"></span> *X = N - Gloss Black</li> <li><span style="display: inline-block; width: 10px; height: 10px; border: 1px solid black; border-radius: 50%; background-color: #8B4513; margin-right: 5px;"></span> Le Terre di Cielo</li> </ul>	95,00 114,00 139,00		
 <b>Universal click/clack drain in BLACK MATT finish with ceramic lid</b> / Válvula universal click/clack Negro Matt con tapa en cerámica / Bonde universelle clic/clac Noir Mat avec clapet en céramique Universal-Abflussgarnitur Click-Clack Matt Schwarz mit Keramikstopfen Универсальный донный клапан click/clack черный матовый с керамической крышкой	PIL01NM(X)*	0,40	<ul style="list-style-type: none"> <li><span style="display: inline-block; width: 10px; height: 10px; border: 1px solid black; border-radius: 50%; background-color: white; margin-right: 5px;"></span> Gloss White</li> <li><span style="display: inline-block; width: 10px; height: 10px; border: 1px solid black; border-radius: 50%; background-color: black; margin-right: 5px;"></span> *X = N - Gloss Black</li> <li><span style="display: inline-block; width: 10px; height: 10px; border: 1px solid black; border-radius: 50%; background-color: #8B4513; margin-right: 5px;"></span> Le Terre di Cielo</li> </ul>	120,00 159,00 169,00		
 <b>Universal click/clack drain in CEMENTO finish with ceramic lid</b> Válvula universal click/clack Cemento con tapa en cerámica Bonde universelle clic/clac Cemento avec clapet en céramique Universal-Abflussgarnitur Click-Clack Cement mit Keramikstopfen Универсальный донный Cemento click/clack с керамической крышкой	PIL01CM(X)*	0,40	<ul style="list-style-type: none"> <li><span style="display: inline-block; width: 10px; height: 10px; border: 1px solid black; border-radius: 50%; background-color: white; margin-right: 5px;"></span> Gloss White</li> <li><span style="display: inline-block; width: 10px; height: 10px; border: 1px solid black; border-radius: 50%; background-color: black; margin-right: 5px;"></span> *X = N - Gloss Black</li> <li><span style="display: inline-block; width: 10px; height: 10px; border: 1px solid black; border-radius: 50%; background-color: #8B4513; margin-right: 5px;"></span> Le Terre di Cielo</li> </ul>	120,00 159,00 169,00		
 <b>Universal click/clack drain in BRONZE with ceramic lid</b> Válvula universal click/clack Bronce con tapa en cerámica Bonde universelle clic/clac Bronze avec clapet en céramique Universal-Abflussgarnitur Click-Clack Bronze mit Keramikstopfen Универсальный донный клапан click/clack бронза с керамической крышкой	PIL01BR(X)*	0,40	<ul style="list-style-type: none"> <li><span style="display: inline-block; width: 10px; height: 10px; border: 1px solid black; border-radius: 50%; background-color: white; margin-right: 5px;"></span> Gloss White</li> <li><span style="display: inline-block; width: 10px; height: 10px; border: 1px solid black; border-radius: 50%; background-color: black; margin-right: 5px;"></span> *X = N - Gloss Black</li> <li><span style="display: inline-block; width: 10px; height: 10px; border: 1px solid black; border-radius: 50%; background-color: #8B4513; margin-right: 5px;"></span> Le Terre di Cielo</li> </ul>	135,00 171,00 182,00		

## Technical symbols legend

Símbolos técnicos clave / Légende symboles techniques / Technische Zeichenerklärung / Перечень технических символов

**one tap hole**  
con 1 agujero  
monotrou  
1-Loch  
одно отверстие под смеситель

**no tap hole on request**  
sin agujero, solo a petición  
sans orifice sur demande  
auf Anfrage ohne Loch  
без отверстия под смеситель по запросу

**without overflow (LGFREE)**  
sin rebosadero (LGFREE)  
sans trop-plein (LGFREE)  
ohne Überlauf (LGFREE)  
без слива-перелива (LGFREE)

**all sides are enamelled**  
con todos los lados esmaltados  
avec tous les côtés émaillés  
alle Seiten glasiert  
все стороны глазурированные

**freestanding installation**  
instalación freestanding a pared  
installation autoportante murale  
freistehende Montage  
свободностоящая пристенная установка

**one side is unglazed**  
con un lado sin esmaltar  
avec un côté non émaillé  
eine Seite unglasiert  
одна сторона не глазурированная

**wall-hung installation**  
instalación suspendida  
installation suspendue  
wandhängende Montage  
подвесная установка







**without overflow, overflow on request (LGLS70, LGLS56)**  
sin rebosadero, con rebosadero solo a petición (LGLS70, LGLS56)  
sans trop-plein, avec trop-plein sur demande (LGLS70, LGLS56)  
ohne Überlauf, auf Anfrage mit Überlauf (LGLS70, LGLS56)  
без слива-перелива, с переливом по запросу (LGLS70, LGLS56)

**with fixing parts**  
fijaciones incluidas  
fixations incluses  
inklusive Befestigungen  
в комплекте с крепежами

# Le Giare

washbasins / lavabi / Aufsatzbecken / Раковина

# cielo









	Size (cm)	Product code	Net weight (Kg)	Finishes	Euro	Pz.	Pz.
	Medidas Dimensions Maße Размеры	Artículo Article Artikel Артикул	Peso neto Poids net Reingewicht вес нетто	Acabados Finitions Farbe Отделка	Евро	шт. pallet Italia	шт. pallet Cont.
 <p><b>Wall-hung washbasin 70, overflow on request, with fixing kit</b>                      Lavabo suspendido 70, con rebosadero en requesta, completo con fijaciones                      Lavabo suspendu 70, trop plein sur demande, avec fixation                      Hängender Waschbecken 70, mit Überlaufschutz auf Anfrage, mit Befestigungskit                      Раковина подвесная на стену 70, с переливом по запросу, в комплекте с крепежами</p>	70 x 56 x 59 h	LGLS70(X)* LGLS70SF(X)* no tap hole sin agujero sans orifice ohne Loch без отверстия	34,30	Gloss White *X = N - Gloss Black Le Terre di Cielo	2862,00 4204,00 4633,00	4	6
 <p><b>Wall-hung washbasin 56, overflow on request, with fixing kit</b>                      Lavabo suspendido 56, con rebosadero en requesta, completo con fijaciones                      Lavabo suspendu 56, trop plein sur demande, avec fixation                      Hängender Waschbecken 56, mit Überlaufschutz auf Anfrage, mit Befestigungskit                      Раковина подвесная на стену 56, с переливом по запросу, в комплекте с крепежами</p>	56 x 45 x 35 h	LGLS56(X)* LGLS56SF(X)* no tap hole sin agujero sans orifice ohne Loch без отверстия	17,60	Gloss White *X = N - Gloss Black Le Terre di Cielo	632,00 908,00 1086,00	12	20
 <p><b>Washbasin siphon for Le Giare (mandatory)</b>                      Sifon para lavabo Le Giare (obligatorio)                      Siphon pour lavabo Le Giare (nécessaire)                      Siphon für Waschtisch Le Giare (geböten)                      Сифон для раковины Le Giare (обязательный)</p>		SIFR	0,51		76,00		
 <p><b>Universal click/clack drain in CHROME with ceramic lid</b>                      Válvula universal click/clack Cromado con tapa en cerámica                      Bonde universelle clic/clac Chromé avec clapet en céramique                      Universal-Abflussgarnitur Click-Clack Chrom mit Keramikstopfen                      Универсальный донный клапан click/clack хром с керамической крышкой</p>		PIL01(X)*	0,40	Gloss White *X = N - Gloss Black Le Terre di Cielo	95,00 114,00 139,00		
 <p><b>Universal click/clack drain in BLACK MATT finish with ceramic lid</b>                      Válvula universal click/clack Negro Matt con tapa en cerámica / Bonde universelle clic/clac Noir Mat avec clapet en céramique                      Universal-Abflussgarnitur Click-Clack Matt Schwarz mit Keramikstopfen                      Универсальный донный клапан click/clack черный матовый с керамической крышкой</p>		PIL01NM(X)*	0,40	Gloss White *X = N - Gloss Black Le Terre di Cielo	120,00 159,00 169,00		
 <p><b>Universal click/clack drain in CEMENTO finish with ceramic lid</b>                      Válvula universal click/clack Cemento con tapa en cerámica                      Bonde universelle clic/clac Cemento avec clapet en céramique                      Universal-Abflussgarnitur Click-Clack Cement mit Keramikstopfen                      Универсальный донный клапан click/clack с керамической крышкой</p>		PIL01CM(X)*	0,40	Gloss White *X = N - Gloss Black Le Terre di Cielo	120,00 159,00 169,00		
 <p><b>Universal click/clack drain in BRONZE with ceramic lid</b>                      Válvula universal click/clack Bronce con tapa en cerámica                      Bonde universelle clic/clac Bronze avec clapet en céramique                      Universal-Abflussgarnitur Click-Clack Bronze mit Keramikstopfen                      Универсальный донный клапан click/clack бронза с керамической крышкой</p>		PIL01BR(X)*	0,40	Gloss White *X = N - Gloss Black Le Terre di Cielo	135,00 171,00 182,00		







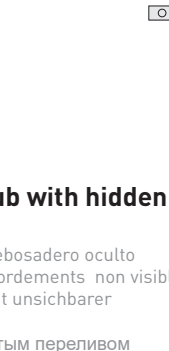





















- Le Terre di Cielo
- TL - Talco
  - PM - Pomice
  - BR - Brina
  - BA - Basalto
  - LV - Lavagna
  - CM - Cemento
  - FN - Fango
  - CA - Cacao
  - AN - Arenaria
  - AV - Avena
  - LN - Lino
  - AG - Agave
  - MU - Muschio
  - PL - Polvere
  - CP - Cipria
  - CN - Canapa

# Le Giare

washbasins, bath tub, mirror

# cielo

		<b>Size (cm)</b> Medidas Dimensions Maße Размеры	<b>Product code</b> Artículo Article Artikel Артикул	<b>Net weight (Kg)</b> Peso neto Poids net Reingewicht вес нетто	<b>Finishes</b> Acabados Finitions Farbe Отделки	<b>Euro</b> Евро	<b>Pz.</b> шт. pallet Italia	<b>Pz.</b> шт. pallet Cont.
<b>Wall-hung washbasin 34 with fixing kit</b> Lavabo suspendido a pared 34 completo con fijaciones Lavabo suspendu 34, completo con fijaciones Hängender waschbecken 34 mit befestigungskit Раковина подвесная на стену 34, в комплекте с крепежами		34 x 50 x 30 h	LGLS(X)*	14,30	● Gloss White ● *X = N - Gloss Black ● Le Terre di Cielo	477,00 684,00 820,00	18	18
 <b>Washbasin siphon for Le Giare wall-hung washbasin (recommended)</b> Sifon para lavabo suspendido Le Giare (aconsejado) Siphon pour lavabo suspendu Le Giare (informé) Siphon für Hängender waschbecken Le Giare (empfohlen) Сифон для раковины Le Giare (рекомендуется)			SIFR	0,51		76,00		
 <b>On top washbasin 60</b> Lavabo sobre encimera 60 / Vasque á poser carrée 60 Aufsatzbecken cariert 60 / Раковина накладная 60		60 x 45 x 14,5 h	LGLA60(X)*	10,85	● Gloss White ● *X = N - Gloss Black ● Le Terre di Cielo ● Le Pietre	451,00 683,00 877,00 1055,00	20	40
 <b>Le Giare Livingtec bath tub with hidden overflow</b> Bañera Le Giare de LivingTec con reebosadero oculto Baignoire le Giare in LivingTec à débordements non visible Le Giare Badewanne aus livingtec mit unsichtbarer Überlaufschutz Ванна "Le Giare" LivingTec со скрытым переливом		190 x 119 x 60 h	LGBAT	148,00	● Matt White ● Brina ● Arenaria	8058,00 9807,00 9807,00		
 <b>Pop up bath tub waste with hidden overflow (mandatory)</b> Sistema de desagüe con sifon para bañera Le Giare (obligatorio) \ Colonne de vidange siphonnée pour la baignoire Le Giare (nécessaire) \ Badewanneablaufgarnitur für Badewanne Le Giare (geböten) \ Сливной механизм с сифоном для ванны "Le Giare" (обязательный)			LGMEC	0,75		312,00		
 <b>Mirror</b> Espejo \ Miroir \ Spiegel \ зеркало		62 x 2,5 x 87 h	LGSP	11,00		387,00		







	Product code Artículo Article Artikel Артикул	Net weight (Kg) Peso neto Poids net Reingewicht вес нетто	Finishes Acabados Finitions Farbe Отделка	Euro Евро
 <p><b>Universal click/clack drain in CHROME with ceramic lid</b> Válvula universal click/clack Cromado con tapa en cerámica Bonde universelle clic/clac Chromé avec clapet en céramique Universal-Ablaufgarnitur Click-Clack Chrom mit Keramikstopfen Универсальный донный клапан click/clack хром с керамической крышкой</p>	PIL01(X)*	0,40	<ul style="list-style-type: none"> <li> <b>Gloss White</b></li> <li> *X = N - <b>Gloss Black</b></li> <li> <b>Le Terre di Cielo</b></li> <li> <b>Le Pietre</b></li> </ul>	<p><b>95,00</b></p> <p><b>114,00</b></p> <p><b>139,00</b></p> <p><b>148,00</b></p>
 <p><b>Universal click/clack drain in BLACK MATT finish with ceramic lid</b> Válvula universal click/clack Negro Matt con tapa en cerámica Bonde universelle clic/clac Noir Mat avec clapet en céramique Universal-Ablaufgarnitur Click-Clack Matt Schwarz mit Keramikstopfen Универсальный донный клапан click/clack черный матовый с керамической крышкой</p>	PIL01NM(X)*	0,40	<ul style="list-style-type: none"> <li> <b>Gloss White</b></li> <li> *X = N - <b>Gloss Black</b></li> <li> <b>Le Terre di Cielo</b></li> <li> <b>Le Pietre</b></li> </ul>	<p><b>120,00</b></p> <p><b>159,00</b></p> <p><b>169,00</b></p> <p><b>185,00</b></p>
 <p><b>Universal click/clack drain in CEMENTO finish with ceramic lid</b> Válvula universal click/clack Cemento con tapa en cerámica Bonde universelle clic/clac Cemento avec clapet en céramique Universal-Ablaufgarnitur Click-Clack Cement mit Keramikstopfen Универсальный донный клапан click/clack с керамической крышкой</p>	PIL01CM(X)*	0,40	<ul style="list-style-type: none"> <li> <b>Gloss White</b></li> <li> *X = N - <b>Gloss Black</b></li> <li> <b>Le Terre di Cielo</b></li> <li> <b>Le Pietre</b></li> </ul>	<p><b>120,00</b></p> <p><b>159,00</b></p> <p><b>169,00</b></p> <p><b>185,00</b></p>
 <p><b>Universal click/clack drain in BRONZE with ceramic lid</b> Válvula universal click/clack Bronce con tapa en cerámica Bonde universelle clic/clac Bronze avec clapet en céramique Universal-Ablaufgarnitur Click-Clack Bronze mit Keramikstopfen Универсальный донный клапан click/clack бронза с керамической крышкой</p>	PIL01BR(X)*	0,40	<ul style="list-style-type: none"> <li> <b>Gloss White</b></li> <li> *X = N - <b>Gloss Black</b></li> <li> <b>Le Terre di Cielo</b></li> <li> <b>Le Pietre</b></li> </ul>	<p><b>135,00</b></p> <p><b>171,00</b></p> <p><b>182,00</b></p> <p><b>185,00</b></p>
 <p><b>CHROMED siphon</b> Sifone Cromado \ Siphon Chromé \ Siphon Verchromt \ сифон Chrome</p>	SISP	0,93	<ul style="list-style-type: none"> <li> <b>Chrome</b></li> </ul>	<b>133,00</b>
 <p><b>MATT BLACK siphon</b> Sifone Negro Mate \ Siphon Noir Mat \ Siphon Schwarz Matt \ Сифон Черный матовый</p>	SIFN	0,93	<ul style="list-style-type: none"> <li> <b>Matt Black</b></li> </ul>	<b>194,00</b>
 <p><b>CEMENTO siphon</b> Sifone Cemento \ Siphon Cemento \ Siphon Cemento \ сифон Cemento</p>	SIFCM	0,93	<ul style="list-style-type: none"> <li> <b>Cemento</b></li> </ul>	<b>194,00</b>
 <p><b>BRONZE siphon</b> Sifone Bronce \ Siphon Bronce \ Siphon Bronze \ бронза сифон</p>	SIFBR	0,93	<ul style="list-style-type: none"> <li> <b>Bronze</b></li> </ul>	<b>220,00</b>

## Technical symbols legend

Símbolos técnicos clave | Légende symboles techniques | Technische Zeichenerklärung | Перечень технических символов

 <p><b>with overflow</b> con rebosadero avec trop-plein mit Überlauf с переливом</p>	 <p><b>without overflow</b> sin rebosadero sans trop-plein ohne Überlauf без слива-перелива</p>	 <p><b>one tap hole</b> con 1 agujero monotrou 1-Loch одно отверстие под смеситель</p>	 <p><b>no tap holes</b> sin agujero para grifo sans orifice robinet ohne Hahnloch без отверстия под смеситель</p>	 <p><b>one side is unglazed</b> con un lado sin esmaltar avec un côté non émaillé eine Seite unglasiert одна сторона не покрыта эмалью</p>	 <p><b>all sides are enamelled</b> con todos los lados esmaltados avec tous les côtés émaillés alle Seiten glasiert все стороны покрыты эмалью</p>
 <p><b>on top installation</b> instalación de apoyo installation à partir du plan Montage auf Platte установка на столешницу</p>	 <p><b>wall-hung installation</b> instalación suspendida installation suspendue wandhängende Montage подвесная установка</p>	 <p><b>with fixing parts</b> fijaciones incluidas fixations incluses inklusive Befestigungen в комплекте с крепежами</p>			

<b>Le Terre di Cielo</b>	 <b>TL - Talco</b>	 <b>PM - Pomice</b>	 <b>BR - Brina</b>	 <b>BA - Basalto</b>	 <b>LV - Lavagna</b>	 <b>CM - Cemento</b>	 <b>FN - Fango</b>	 <b>CA - Cacao</b>
	 <b>AN - Arenaria</b>	 <b>AV - Avena</b>	 <b>LN - Lino</b>	 <b>AG - Agave</b>	 <b>MU - Muschio</b>	 <b>PL - Polvere</b>	 <b>CP - Cipria</b>	 <b>CN - Canapa</b>
<b>Le Pietre</b>	 <b>CS - Carrara Statuario</b>	 <b>BC - Breccia Arabescata</b>	 <b>GS - Grey Stone</b>	 <b>BP - Breccia Paradiso</b>	 <b>NQ - Nero Marquina</b>			

	Size (cm)	Product code	Net weight (kg)	Finishes	Euro	Pz.	Pz.
	Medidas Dimensions Maße Размеры	Artículo Article Artikel Артикул	Peso neto Poids net Reingewicht вес нетто	Acabados Finitions Farbe Отделка	Евро	шт. pallet Italia	шт. pallet Cont.
 <p><b>Wall-hung wc with fixing kit (4,5 LT)</b>                      Wc suspendido completo con fijaciones (4,5 LT)                      Wc suspendu avec fixation (4,5 LT)                      Wand-WC mit Befestigungskit (4,5 LT)                      Унитаз подвесной в комплекте с крепежами (4,5 LT)</p>	37 x 55 x 37,5 h	LGVS(X)*	22,00	● Gloss White ● *X = N - Gloss Black ● *X = TL - Talco ● Le Terre di Cielo*	634,00 941,00 941,00 1011,00	18	18
 <p><b>Thermosetting seat &amp; cover</b>                      Asiento para inodoro                      Abattant thermodurcissable                      Wc-sitz thermodur                      Сиденье из термоотверждающейся смолы</p>		CPVLGT	2,40	● Gloss White	110,00		
 <p><b>Thermosetting soft close seat &amp; cover</b>                      Asiento para inodoro amortiguado                      Abattant thermodurcissable soft                      Wc-sitz thermodur mit Abs.                      Сиденье из термоотверждающейся смолы с плавным опусканием</p>		CPVLGTF(X)*	2,40	● Gloss White ● *X = N - Gloss Black ● *X = TL - Talco ● Le Terre di Cielo*	172,00 253,00 296,00 316,00		
 <p><b>Impact and acoustic protection panel</b>                      Protección antigolpes y acústica /                      Protection acoustique et anti-choc /                      Stoss- und Schalldämmung /                      Противоударная и акустическая защита</p>		PAA	0,16		17,00		
 <p><b>Couple of fixing brackets for wall-hung wc/bidet</b>                      Pareja de estribo para Inodoro/Bidet suspendido /                      Étriers de fixation pour Wc/Bidet suspendus /                      1 Paar Halterungen für wandhängendes Wc/Bidet /                      Монтажная рама для подвесного унитаза/биде</p>	3,3 x 18,5 x 55 h	508	2,00		39,00		

























## Technical symbols legend

Símbolos técnicos clave | Légende symboles techniques | Technische Zeichenerklärung | Перечень технических символов









 <p><b>with overflow</b>                      con rebosadero                      avec trop-plein                      mit Überlauf                      с переливом</p>	 <p><b>one tap hole</b>                      con 1 agujero                      monotrou                      1-Loch                      одно отверстие                      под смеситель</p>	 <p><b>wall-hung installation</b>                      instalación suspendida                      installation suspendue                      wandhängende Montage                      подвесная установка</p>	 <p><b>with fixing parts</b>                      fijaciones incluidas                      fixations incluses                      inklusive                      Befestigungen                      в комплекте с                      крепежами</p>	 <p><b>4,5 l toilet tank</b>                      descarga 4,5 lt                      évacuation à 4,5 l                      4,5 l-Spülung                      бачок на 4,5 л</p>	 <p><b>Combifix compatibility</b>                      compatible Combifix                      mit Combifix kompatibel                      совместим с combifix</p>
--	--	---	---	---	--

\* Terre di Cielo finishes available for wc-bidet /  
 Acabados Terre di Cielo disponibles para wc-bidet | Finitions  
 Terre di Cielo disponibles pour cuvette-bidet | Für das WC/  
 Bidet erhältliche Ausführungen Terre di Cielo | omделка  
 Terre di Cielo доступны для унитаза и биде

● TL - Talco ● PM - Pomice ● BR - Brina ● AN - Arenaria ● AV - Avena ● CM - Cemento ● BA - Basalto ● LV - Lavagna

	Size (cm)	Product code	Net weight(Kg)	Finishes	Euro	Pz.	Pz.
	Medidas Dimensions Maße Размеры	Artículo Article Artikel Артикул	Peso neto Poids net Reingewicht вес нетто	Acabados Finitions Farbe Отделки	Евро	шт. pallet Italia	шт. pallet Cont.
  <p><b>Wall-hung one hole bidet with fixing kit /</b> Bidé suspendido monoagujero completa con fijación / Bidet suspendu monotrou, fixations incluses / Wand-Bidet einloch mit Befestigungskit / Биде подвесное с одним отверстием под смеситель, в комплекте с крепежами</p>	37 x 55 x 33,5 h	LGBSREV(X)*	20,10	<ul style="list-style-type: none"> <li> <b>Gloss White</b></li> <li> <b>*X = N - Gloss Black</b></li> <li> <b>*X = TL - Talco</b></li> <li> <b>Le Terre di Cielo*</b></li> </ul>	<p>634,00</p> <p>941,00</p> <p>941,00</p> <p>1011,00</p>	18	18
 <p><b>Washbasin siphon for Le Giare (recommended)</b> Sifon para lavabo Le Giare (aconsejado) / Siphon pour lavabo Le Giare (informé) / Siphon für Waschtisch Le Giare (empfohlen) / Сифон для раковины Le Giare (рекомендуется)</p>		SIFR	0,51		76,00		
 <p><b>Impact and acoustic protection panel</b> Protección antigolpes y acústica / Protection acoustique et anti- choc / Stoss-und Schalldämmung / Противоударная и акустическая защита</p>		PAA	0,16		17,00		
 <p><b>Couple of fixing brackets for wall-hung wc/bidet - Pareja de estribo para Inodoro/Bidet suspendido / Étriers de fixation pour Wc/Bidet suspendus / 1 Paar Halterungen für wandhängendes Wc/Bidet / Монтажная рама для подвесного унитаза/биде</b></p>	3,3 x 18,5 x 55 h	508	2,00		39,00		
 <p><b>Universal click/clack drain in CHROME with ceramic lid</b> Válvula universal click/clack Cromado con tapa en cerámica Bonde universelle clic/clac Chromé avec clapet en céramique Universal-Abflussgarnitur Click-Clack Chrom mit Keramikstopfen Универсальный донный клапан click/clack хром с керамической крышкой</p>		PIL01(X)*	0,40	<ul style="list-style-type: none"> <li> <b>Gloss White</b></li> <li> <b>*X = N - Gloss Black</b></li> <li> <b>Le Terre di Cielo</b></li> </ul>	<p>95,00</p> <p>114,00</p> <p>139,00</p>		
 <p><b>Universal click/clack drain in BLACK MATT finish with ceramic lid</b> Válvula universal click/clack Negro Matt con tapa en cerámica Bonde universelle clic/clac Noir Mat avec clapet en céramique Universal-Abflussgarnitur Click-Clack Matt Schwarz mit Keramikstopfen Универсальный донный клапан click/clack черный матовый с керамической крышкой</p>		PIL01NM(X)*	0,40	<ul style="list-style-type: none"> <li> <b>Gloss White</b></li> <li> <b>*X = N - Gloss Black</b></li> <li> <b>Le Terre di Cielo</b></li> </ul>	<p>120,00</p> <p>159,00</p> <p>169,00</p>		
 <p><b>Universal click/clack drain in CEMENTO finish with ceramic lid</b> Válvula universal click/clack Cemento con tapa en cerámica Bonde universelle clic/clac Cemento avec clapet en céramique Universal-Abflussgarnitur Click-Clack Cement mit Keramikstopfen Универсальный донный Cemento click/clack с керамической крышкой</p>		PIL01CM(X)*	0,40	<ul style="list-style-type: none"> <li> <b>Gloss White</b></li> <li> <b>*X = N - Gloss Black</b></li> <li> <b>Le Terre di Cielo</b></li> </ul>	<p>120,00</p> <p>159,00</p> <p>169,00</p>		
 <p><b>Universal click/clack drain in BRONZE with ceramic lid</b> Válvula universal click/clack Bronze con tapa en cerámica Bonde universelle clic/clac Bronze avec clapet en céramique Universal-Abflussgarnitur Click-Clack Bronze mit Keramikstopfen Универсальный донный клапан click/clack бронза с керамической крышкой</p>		PIL01BR(X)*	0,40	<ul style="list-style-type: none"> <li> <b>Gloss White</b></li> <li> <b>*X = N - Gloss Black</b></li> <li> <b>Le Terre di Cielo</b></li> </ul>	<p>135,00</p> <p>171,00</p> <p>182,00</p>		



	Size (cm)	Product code	Net weight (Kg)	Finishes	Euro	Pz.	Pz.
	Medidas Dimensions Maße Размеры	Artículo Article Artikel Артикул	Peso neto Poids net Reingewicht вес нетто	Acabados Finitions Farbe Отделки	Евро	шт. pallet Italia	шт. pallet Cont.
 <p><b>Wc with horizontal outlet convertible to floor outlet by technical curve (4,5 LT)</b>                      Wc con desagüe a pared convertible a suelo con curva técnica (4,5 LT)                      Wc avec évacuation murale transformable à terre avec courbe technique (4,5l)                      WC mit Wandabfluss, durch Kurventechnik auf Bodenabfluss umrüstbar (4,5 LT)                      Слив в стену при помощи технического колена трансформируется на слив в пол (4,5 л)</p>	37 x 55 x 42,5 h	LGVA	28,10	 <b>Gloss White</b>	<b>491,00</b>	15	20
 <p><b>Thermosetting seat &amp; cover</b>                      Asiento para inodoro                      Abattant thermodurcissable                      Wc-sitz thermodur                      Сиденье из термоотверждающейся смолы</p>		CPVLGT	2,40	 <b>Gloss White</b>	<b>110,00</b>		
 <p><b>Thermosetting soft close seat &amp; cover</b>                      Asiento para inodoro amortiguado                      Abattant thermodurcissable soft                      Wc-sitz thermodur mit Abs.                      Сиденье из термоотверждающейся смолы с плавным опусканием</p>		CPVLGTF	2,40	 <b>Gloss White</b>	<b>172,00</b>		
 <p><b>Technical curve "floor trap" for toilet</b>                      Curva técnica "salida vertical" para inodoro                      Courbe technique à S pour cuvette avec sortie au sol                      WC-Ablaufbogen "S"                      Колено "S"-образное для унитазов, регулируемое</p>		CSB	0,40		<b>18,00</b>		
 <p><b>Straight pan connector for wall trap</b>                      Anclaje a pared para inodoro                      Pipe pour sortie horizontale                      WC-Anschlussstutzen für Abgang waagerecht                      Фитинг для выпуска в стену для унитазов</p>		RPB	0,35		<b>15,00</b>		

## Technical symbols legend











Símbolos técnicos clave | Légende symboles techniques | Technische Zeichenerklärung | Перечень технических символов

 **back to wall installation**  
 instalación a suelo  
 installation à terre  
 bodenstehende Montage  
 напольная установка

 **with fixing parts**  
 fijaciones incluidas  
 fixations incluses  
 inklusive Befestigungen  
 в комплекте с крепежами

 **4,5 l toilet tank**  
 descarga 4,5 lt  
 évacuation à 4,5 l  
 4,5 l-Spülung  
 бачок на 4,5 л

 **bifunctional drain**  
 descarga bifuncional  
 évacuation bifonctionnelle  
 Spülung mit zwei  
 Montagevarianten  
 функциональный бачок

	Size (cm)	Product code	Net weight (Kg)	Finishes	Euro	Pz.	Pz.
	Medidas Dimensions Maße Размеры	Artículo Article Artikel Артикул	Peso neto Poïds net Reingewicht вес нетто	Acabados Finitions Farbe Отделки	Евро	шт. pallet Italia	шт. pallet Cont.
 <p><b>Back to wall one hole bidet</b> Bidet a suelo monoagujero Bidet au sol monotrou Stand-bidet einloch Биде напольное с одним отверстием под смеситель</p>	37 x 55 x 42,5 h	LGBIREV	24,30	 <b>Gloss White</b>	<b>491,00</b>	15	20
 <p><b>Universal click/clack drain in CHROME with ceramic lid</b> Válvula universal click/clack Cromado con tapa en cerámica Bonde universelle clic/clac Chromé avec clapet en céramique Universal-Ablaufgarnitur Click-Clack Chrom mit Keramikstopfen Универсальный донный клапан click/clack хром с керамической крышкой</p>		PIL01(X)*	0,40	 <b>Gloss White</b>	<b>95,00</b>		
 <p><b>Universal click/clack drain in BLACK MATT finish with ceramic lid</b> Válvula universal click/clack Negro Matt con tapa en cerámica Bonde universelle clic/clac Noir Mat avec clapet en céramique Universal-Ablaufgarnitur Click-Clack Matt Schwarz mit Keramikstopfen Универсальный донный клапан click/clack черный матовый с керамической крышкой</p>		PIL01NM(X)*	0,40	 <b>Gloss White</b>	<b>120,00</b>		
 <p><b>Universal click/clack drain in CEMENTO finish with ceramic lid</b> Válvula universal click/clack Cemento con tapa en cerámica Bonde universelle clic/clac Cemento avec clapet en céramique Universal-Ablaufgarnitur Click-Clack Cement mit Keramikstopfen Универсальный донный Cemento click/clack с керамической крышкой</p>		PIL01CM(X)*	0,40	 <b>Gloss White</b>	<b>120,00</b>		
 <p><b>Universal click/clack drain in BRONZE with ceramic lid</b> Válvula universal click/clack Bronce con tapa en cerámica Bonde universelle clic/clac Bronze avec clapet en céramique Universal-Ablaufgarnitur Click-Clack Bronze mit Keramikstopfen Универсальный донный клапан click/clack бронза с керамической крышкой</p>		PIL01BR(X)*	0,40	 <b>Gloss White</b>	<b>135,00</b>		

## Technical symbols legend

Simbolos técnicos clave | Légende symboles techniques | Technische Zeichenerklärung | Перечень технических символов

 <b>one tap hole</b> con 1 agujero monotrou 1-Loch одно отверстие под смеситель	 <b>with overflow</b> con rebosadero avec trop-plein mit Überlauf с переливом	 <b>back to wall installation</b> instalación a suelo installation à terre bodenstehende Montage напольная установка	 <b>with fixing parts</b> fijaciones incluidas fixations incluses inklusive Befestigungen в комплекте с крепежами
---	--	---	--



# Shui Comfort / Shui

design Paolo D'Arrigo

## SHUI COMFORT

indice collezione \ collection index pg. 431

listino prezzi \ price list pg. 432 - 442

## SHUI

indice collezione \ collection index pg. 445

listino prezzi \ price list pg. 448 - 456







## Washbasins finishes

Acabados de Lavabos  
Finitions des Lavabos  
Waschbecken Farbe  
Отделки Раковина





-  Gloss White
-  N - Gloss Black

## Le Terre di Cielo

-  TL - Talco
-  PM - Pomice
-  BR - Brina
-  CM - Cemento
-  BA - Basalto
-  LV - Lavagna
-  FN - Fango
-  CA - Cacao
-  AN - Arenaria
-  AV - Avena
-  MU - Muschio
-  AG - Agave
-  LN - Lino
-  CN - Canapa
-  CP - Cipria
-  PL - Polvere

## Le Pietre

[SHCOLAQ40 - SHCOLAR60 -  
SHCOLAT40 - SHCOLA060]

-  CS - Carrara Statuario
-  BC - Breccia Arabescata
-  GS - Grey Stone
-  BP - Breccia Paradiso
-  NQ - Nero Marquina

## Le Acque di Cielo

-  OL - Oltremare
-  SM - Smeraldo
-  AL - Alga
-  CO - Corallo
-  NI - Ninfea
-  AM - Anemone

## WC and Bidets finishes

Acabados de Sanitarios  
Finitions des WC et Bidets  
WC und Bidet Farbe  
Отделки Унитаз и Биде



-  Gloss White
-  N - Gloss Black
-  TL - Talco

## Le Terre di Cielo

-  PM - Pomice
-  BR - Brina
-  AV - Avena
-  AN - Arenaria
-  CM - Cemento
-  BA - Basalto
-  LV - Lavagna

## Bath tub finish

Acabados de la Bañadera  
Finitions de la Baignoire  
Badewanne Farbe  
Отделки ванна

-  Matt White
-  Brina
-  Arenaria

The possible variations of the colour cannot be considered as defect, but as a guarantee of the completely artisan manufacturing of this unique and high quality product.

Las variaciones de colores no se consideran un defecto sino una garantía de una elaboración manual y artesanal en un producto único y de calidad.

Les éventuelles variations de couleur ne peuvent être considérées comme des défauts, elles témoignent en revanche d'une méthode de travail totalement manuelle et artisanale employée pour obtenir un produit fini unique et de qualité.

Eventuelle Farbvariationen sind nicht als Mangel anzusehen, sondern als Garantie für die komplett handwerkliche Anfertigung eines einzigartigen und hochqualitativen Produkts.

Возможные вариации цвета не могут считаться дефектом, а являются подтверждением ручной работы, гарантией качества и уникальности изделия.

## Lavabi / washbasins

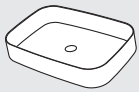

**SHCOLAR60**  
60 x 40 x 12,5 h  
pag. 432

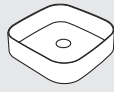

**SHCOLAQ40**  
40 x 40 x 12,5 h  
pag. 432

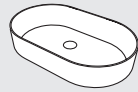

**SHCOLA060**  
60 x 38 x 12,5 h  
pag. 432

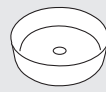

**SHCOLAT40**  
40 x 40 x 12,5 h  
pag. 432



**MILAT**  
25 x 25 x 11,5 h  
pag. 432



**MILAQ**  
25 x 25 x 11,5 h  
pag. 432

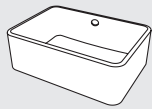

**SHLAA6020**  
60 x 42 x 20 h  
pag. 434

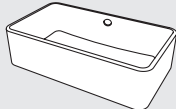

**SHLAA7520**  
75 x 42 x 20 h  
pag. 434

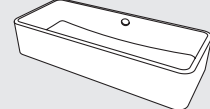

**SHLAA10020**  
100 x 42 x 20 h  
pag. 434

## Lavabi monoforo / washbasins with one hole

**installazione sospesa o da piano**  
wall-hung or on top installation

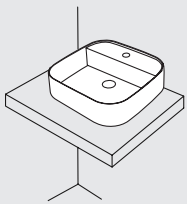

**SHCOLAQF**  
44 x 43 x 13 h  
pag. 434

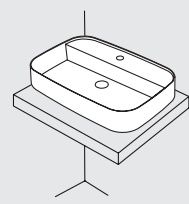
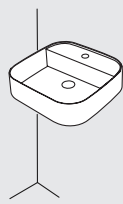

**SHCOLARF**  
60 x 43 x 13 h  
pag. 434

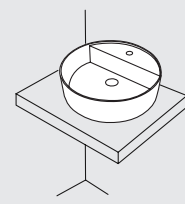
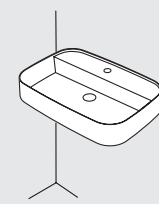

**SHCOLATF**  
ø45 x 13 h  
pag. 434

## Wc - bidet



**SHCOVSK**  
**senza brida / rimless**  
37,5 x 55 x 37,5 h  
pag. 436



**SHCOVS**  
37,5 x 55 x 37,5 h  
pag. 436



**SHCOBS**  
37,5 x 55 x 37,5 h  
pag. 437

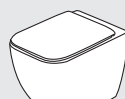

**SHCOVAKTR**  
**senza brida / rimless**  
38 x 55 x 44 h  
pag. 438

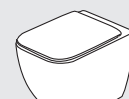

**SHCOVA**  
38 x 55 x 44 h  
pag. 440

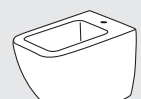

**SHCOBI**  
38 x 55 x 44 h  
pag. 441

## Vasca / bath tub

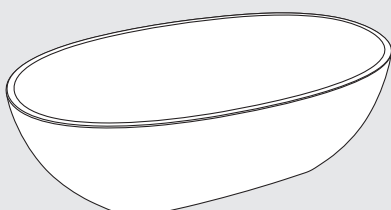





































































**SHCOBAT**  
87 x 170 x 53 h  
pag. 442

# Shui Comfort

washbasins / lavabi / Aufsatzbecken / Раковина

# cielo

		<b>Size (cm)</b> Medidas Dimensions Maße Размеры	<b>Product code</b> Artículo Article Artikel Артикул	<b>Net weight (Kg)</b> Peso neto Poids net Reingewicht вес нетто	<b>Finishes</b> Acabados Finitions Farbe Отделки	<b>Euro</b> Евро	<b>Pz.</b> шт. pallet Italia	<b>Pz.</b> шт. pallet Cont.
 <p><b>Shui Comfort rectangular washbasin 60 x 40</b>                      Lavabo Shui Comfort rectangular 60 x 40                      Lavabo Shui Comfort rectangulaire 60 x 40                      Aufsatzbecken rechteckig Shui Comfort 60 x 40                      Раковина прямоугольная Shui Comfort 60 x 40</p>		60 x 40 x 12,5 h	SHCOLAR60(X)*	10,35	<ul style="list-style-type: none"> <li> Gloss White</li> <li> *X = N - Gloss Black</li> <li> Le Terre di Cielo</li> <li> Le Acque di Cielo</li> <li> Le Pietre</li> </ul>	566,00 734,00 864,00 864,00 1112,00	20	40
 <p><b>Shui Comfort square washbasin 40</b>                      Lavabo Shui Comfort cuadrato 40                      Lavabo Shui Comfort carrè 40                      Aufsatzbecken quadratisch Shui Comfort 40                      Раковина квадрат Shui Comfort 60 x 40</p>		40 x 40 x 12,5 h	SHCOLAQ40(X)*	7,95	<ul style="list-style-type: none"> <li> Gloss White</li> <li> *X = N - Gloss Black</li> <li> Le Terre di Cielo</li> <li> Le Acque di Cielo</li> <li> Le Pietre</li> </ul>	472,00 532,00 757,00 757,00 989,00	26	52
 <p><b>Shui Comfort oval washbasin 60 x 38</b>                      Lavabo Shui Comfort oval 60 x 38                      Lavabo Shui Comfort ovale 60 x 38                      Aufsatzbecken Oval Shui Comfort 60 x 38                      Раковина овальный Shui Comfort 60 x 38</p>		60 x 38 x 12,5 h	SHCOLA060(X)*	9,60	<ul style="list-style-type: none"> <li> Gloss White</li> <li> *X = N - Gloss Black</li> <li> Le Terre di Cielo</li> <li> Le Acque di Cielo</li> <li> Le Pietre</li> </ul>	542,00 723,00 852,00 852,00 1101,00	20	40
 <p><b>Shui Comfort round washbasin 40</b>                      Lavabo Shui Comfort ronda 40                      Lavabo Shui Comfort tour 40                      Aufsatzbecken Runde Shui Comfort 40                      Раковина круглый Shui Comfort 60 x 40</p>		40 x 40 x 12,5 h	SHCOLAT40(X)*	6,85	<ul style="list-style-type: none"> <li> Gloss White</li> <li> *X = N - Gloss Black</li> <li> Le Terre di Cielo</li> <li> Le Acque di Cielo</li> <li> Le Pietre</li> </ul>	434,00 446,00 710,00 710,00 989,00	26	52
 <p><b>Minimo round washbasin</b>                      Lavabo Minimo round ronda                      Lavabo Minimo tour                      Aufsatzbecken Runde Minimo                      Раковина круглый Minimo</p>		25 x 25 x 11,5 h	MILAT(X)*	3,15	<ul style="list-style-type: none"> <li> Gloss White</li> <li> *X = N - Gloss Black</li> <li> Le Terre di Cielo</li> <li> Le Acque di Cielo</li> </ul>	277,00 413,00 413,00 413,00	152	304
 <p><b>Minimo square washbasin</b>                      Lavabo Minimo cuadrato                      Lavabo Minimo carrè                      Aufsatzbecken quadratisch Minimo                      Раковина квадрат Minimo</p>		25 x 25 x 11,5 h	MILAQ(X)*	3,50	<ul style="list-style-type: none"> <li> Gloss White</li> <li> *X = N - Gloss Black</li> <li> Le Terre di Cielo</li> <li> Le Acque di Cielo</li> </ul>	277,00 413,00 413,00 413,00	152	304

	<b>Product code</b> Artículo Article Artikel Артикул	<b>Net weight</b> (Kg) Peso neto Poids net Reingewicht вес нетто	<b>Finishes</b> Acabados Finitions Farbe Отделки	<b>Euro</b> Euro
 <p><b>Universal click/clack drain in CHROME with ceramic lid</b> Válvula universal click/clack Cromado con tapa en cerámica Bonde universelle clic/clac Chromé avec clapet en céramique Universal-Abflussgarnitur Click-Clack Chrom mit Keramikstopfen Универсальный донный клапан click/clack хром с керамической крышкой</p>	PIL01(X)*	0,40	 <b>Gloss White</b>	<b>95,00</b>
			 *X = N - Gloss Black	<b>114,00</b>
			 <b>Le Terre di Cielo</b>	<b>139,00</b>
			 <b>Le Acque di Cielo</b>	<b>139,00</b>
			 <b>Le Pietre</b>	<b>148,00</b>
 <p><b>Universal click/clack drain in BLACK MATT finish with ceramic lid</b> Válvula universal click/clack Negro Matt con tapa en cerámica Bonde universelle clic/clac Noir Mat avec clapet en céramique Universal-Abflussgarnitur Click-Clack Matt Schwarz mit Keramikstopfen Универсальный донный клапан click/clack черный матовый с керамической крышкой</p>	PIL01NM(X)*	0,40	 <b>Gloss White</b>	<b>120,00</b>
			 *X = N - Gloss Black	<b>159,00</b>
			 <b>Le Terre di Cielo</b>	<b>169,00</b>
			 <b>Le Acque di Cielo</b>	<b>169,00</b>
			 <b>Le Pietre</b>	<b>185,00</b>
 <p><b>Universal click/clack drain in CEMENTO finish with ceramic lid</b> Válvula universal click/clack Cemento con tapa en cerámica Bonde universelle clic/clac Cemento avec clapet en céramique Universal-Abflussgarnitur Click-Clack Cement mit Keramikstopfen Универсальный донный Cemento click/clack с керамической крышкой</p>	PIL01CM(X)*	0,40	 <b>Gloss White</b>	<b>120,00</b>
			 *X = N - Gloss Black	<b>159,00</b>
			 <b>Le Terre di Cielo</b>	<b>169,00</b>
			 <b>Le Acque di Cielo</b>	<b>169,00</b>
			 <b>Le Pietre</b>	<b>185,00</b>
 <p><b>Universal click/clack drain in BRONZE with ceramic lid</b> Válvula universal click/clack Bronce con tapa en cerámica Bonde universelle clic/clac Bronze avec clapet en céramique Universal-Abflussgarnitur Click-Clack Bronze mit Keramikstopfen Универсальный донный клапан click/clack бронза с керамической крышкой</p>	PIL01BR(X)*	0,40	 <b>Gloss White</b>	<b>135,00</b>
			 *X = N - Gloss Black	<b>171,00</b>
			 <b>Le Terre di Cielo</b>	<b>182,00</b>
			 <b>Le Acque di Cielo</b>	<b>182,00</b>
			 <b>Le Pietre</b>	<b>185,00</b>
 <p><b>CHROMED siphon</b> Sifone Cromado \ Siphon Chromé \ Siphon Verchromt \ сифон Chrome</p>	SISP	0,93	 <b>Chrome</b>	<b>133,00</b>
 <p><b>MATT BLACK siphon</b> Sifone Negro Mate \ Siphon Noir Mat \ Siphon Schwarz Matt \ Сифон Черный матовый</p>	SIFN	0,93	 <b>Matt Black</b>	<b>194,00</b>
 <p><b>CEMENTO siphon</b> Sifone Cemento \ Siphon Cemento \ Siphon Cemento \ сифон Cemento</p>	SIFCM	0,93	 <b>Cemento</b>	<b>194,00</b>
 <p><b>BRONZE siphon</b> Sifone Bronce \ Siphon Bronze \ Siphon Bronze \ бронза сифон</p>	SIFBR	0,93	 <b>Bronze</b>	<b>220,00</b>

## Technical symbols legend

Simbolos técnicos clave | Légende symboles techniques | Technische Zeichenerklärung | Перечень технических символов





 <b>all sides are enamelled</b> con todos los lados esmaltados avec tous les côtés émaillés alle Seiten glasiert все стороны покрыты эмалью	 <b>no tap holes</b> sin agujero para grifo sans orifice robinet ohne Hahnloch без отверстия под смеситель	 <b>without overflow</b> sin rebosadero sans trop-plein ohne Überlauf без слива-перелива	 <b>on top installation</b> instalación de apoyo installation à partir du plan Montage auf Platte установка на столешницу
---	---	---	--

<b>Le Terre di Cielo</b>	 TL - Talco	 PM - Pomice	 BR - Brina	 BA - Basalto	 LV - Lavagna	 CM - Cemento	 FN - Fango	 CA - Cacao
	 AN - Arenaria	 AV - Avena	 LN - Lino	 AG - Agave	 MU - Muschio	 PL - Polvere	 CP - Cipria	 CN - Canapa
<b>Le Acque di Cielo</b>	 OL - Oltremare	 SM - Smeraldo	 AL - Alga	 CO - Corallo	 NI - Ninfea	 AM - Anemone		
<b>Le Pietre</b>	 CS - Carrara Statuario	 BC - Breccia Arabescata	 GS - Grey Stone	 BP - Breccia Paradiso	 NQ - Nero Marquina			

# Shui Comfort

washbasins / lavabi / Aufsatzbecken / Раковина

# cielo

	Size (cm)	Product code	Net weight(Kg)	Finishes	Euro	Pz.	Pz.
	Medidas Dimensions Maße Размеры	Artículo Article Artikel Артикул	Peso neto Poids net Reingewicht вес нетто	Acabados Finitions Farbe Отделки	Евро	шт. pallet Italia	шт. pallet Cont.
 <p><b>Shui Comfort rectangular washbasin with one hole</b> Lavabo Shui Comfort rectangular con 1 agujero \ Lavabo Shui Comfort rectangulaire monotrou \ Aufsatzbecken rechteckig Shui Comfort 1-Loch \ Раковина прямоугольная Shui Comfort одно отверстие под смеситель</p>	60 x 43 x 13 h	SHCOLARF(X)* SHCOLARSF(X)* no tap hole sin agujero - sans orifice - ohne Loch без отверстия	14,00	<ul style="list-style-type: none"> <li><span style="display: inline-block; width: 10px; height: 10px; background-color: white; border: 1px solid black; border-radius: 50%;"></span> Gloss White</li> <li><span style="display: inline-block; width: 10px; height: 10px; background-color: #8B4513; border: 1px solid black; border-radius: 50%;"></span> Le Terre di Cielo</li> <li><span style="display: inline-block; width: 10px; height: 10px; background-color: #008080; border: 1px solid black; border-radius: 50%;"></span> Le Acque di Cielo</li> </ul>	605,00 868,00 868,00	20	40
 <p><b>Shui Comfort square washbasin with one hole</b> Lavabo Shui Comfort cuadrato con 1 agujero \ Lavabo Shui Comfort carrè monotrou \ Aufsatzbecken quadratisch Shui Comfort 1-Loch \ Раковина квадрат Shui Comfort одно отверстие под смеситель</p>	44 x 43 x 13,5 h	SHCOLAQF(X)* SHCOLAQSF(X)* no tap hole sin agujero - sans orifice - ohne Loch без отверстия	9,50	<ul style="list-style-type: none"> <li><span style="display: inline-block; width: 10px; height: 10px; background-color: white; border: 1px solid black; border-radius: 50%;"></span> Gloss White</li> <li><span style="display: inline-block; width: 10px; height: 10px; background-color: #8B4513; border: 1px solid black; border-radius: 50%;"></span> Le Terre di Cielo</li> <li><span style="display: inline-block; width: 10px; height: 10px; background-color: #008080; border: 1px solid black; border-radius: 50%;"></span> Le Acque di Cielo</li> </ul>	503,00 748,00 748,00	20	34
 <p><b>Shui Comfort round washbasin with one hole</b> Lavabo Shui Comfort ronda con 1 agujero \ Lavabo Shui Comfort tour monotrou \ Aufsatzbecken Runde Shui Comfort 1-Loch \ Раковина круглый Shui Comfort одно отверстие под смеситель</p>	∅45 x 13 h	SHCOLATF(X)* SHCOLATSF(X)* no tap hole sin agujero - sans orifice - ohne Loch без отверстия	8,50	<ul style="list-style-type: none"> <li><span style="display: inline-block; width: 10px; height: 10px; background-color: white; border: 1px solid black; border-radius: 50%;"></span> Gloss White</li> <li><span style="display: inline-block; width: 10px; height: 10px; background-color: #8B4513; border: 1px solid black; border-radius: 50%;"></span> Le Terre di Cielo</li> <li><span style="display: inline-block; width: 10px; height: 10px; background-color: #008080; border: 1px solid black; border-radius: 50%;"></span> Le Acque di Cielo</li> </ul>	485,00 727,00 727,00	20	34
 <p><b>Shui Comfort on top washbasin h20</b> Lavabo Shui Comfort sobre encimera h20 lavabo Shui Comfort à poser h20 Aufsatzbecken Shui Comfort h20 Раковина Shui Comfort h20</p>	100 x 42 x 20 h	SHLAA10020(X)*	30,80	<ul style="list-style-type: none"> <li><span style="display: inline-block; width: 10px; height: 10px; background-color: white; border: 1px solid black; border-radius: 50%;"></span> Gloss White</li> <li><span style="display: inline-block; width: 10px; height: 10px; background-color: black; border: 1px solid black; border-radius: 50%;"></span> *X = N - Gloss Black</li> <li><span style="display: inline-block; width: 10px; height: 10px; background-color: #8B4513; border: 1px solid black; border-radius: 50%;"></span> Le Terre di Cielo</li> <li><span style="display: inline-block; width: 10px; height: 10px; background-color: #008080; border: 1px solid black; border-radius: 50%;"></span> Le Acque di Cielo</li> </ul>	852,00 1082,00 1236,00 1236,00	10	20
	75 x 42 x 20 h	SHLAA7520(X)*	25,15	<ul style="list-style-type: none"> <li><span style="display: inline-block; width: 10px; height: 10px; background-color: white; border: 1px solid black; border-radius: 50%;"></span> Gloss White</li> <li><span style="display: inline-block; width: 10px; height: 10px; background-color: black; border: 1px solid black; border-radius: 50%;"></span> *X = N - Gloss Black</li> <li><span style="display: inline-block; width: 10px; height: 10px; background-color: #8B4513; border: 1px solid black; border-radius: 50%;"></span> Le Terre di Cielo</li> <li><span style="display: inline-block; width: 10px; height: 10px; background-color: #008080; border: 1px solid black; border-radius: 50%;"></span> Le Acque di Cielo</li> </ul>	683,00 954,00 1063,00 1063,00	12	24
	60 x 42 x 20 h	SHLAA6020(X)*	22,25	<ul style="list-style-type: none"> <li><span style="display: inline-block; width: 10px; height: 10px; background-color: white; border: 1px solid black; border-radius: 50%;"></span> Gloss White</li> <li><span style="display: inline-block; width: 10px; height: 10px; background-color: black; border: 1px solid black; border-radius: 50%;"></span> *X = N - Gloss Black</li> <li><span style="display: inline-block; width: 10px; height: 10px; background-color: #8B4513; border: 1px solid black; border-radius: 50%;"></span> Le Terre di Cielo</li> <li><span style="display: inline-block; width: 10px; height: 10px; background-color: #008080; border: 1px solid black; border-radius: 50%;"></span> Le Acque di Cielo</li> </ul>	529,00 722,00 918,00 918,00	16	32

**SHCOLARF\SF - SHCOLAQF\SF :**

































The washbasins are recommended for wall hung installation. For on top installation customers are advised to require the "RETTIFICA" option.

Se recomienda la instalación del lavabo suspendido. Para instalaciones de apoyo se aconseja usar la opción "RETTIFICA". \ La vasque est recommandée pour l'installation suspendu. Pour l'installation à poser on conseille l'option "RETTIFICA".

Es empfiehlt sich, das Waschbecken hängend zu installieren. Bei Aufsatzmontage bitte die Option "RETTIFICA" anfragen. \ Данная раковина предназначена для подвесной установки. При установке на столешницу рекомендуется запросить опцию "RETTIFICA".

**RETTIFICA  
GRINDING  
РЕКТИФИКАЦИЯ**











**10,00**

	Product code Artículo Article Artikel Артикул	Net weight (Kg) Peso neto Poids net Reingewicht вес нетто	Finishes Acabados Finitions Farbe Отделки	Euro Евро
 <p><b>Universal click/clack drain in CHROME with ceramic lid</b> Válvula universal click/clack Cromado con tapa en cerámica Bonde universelle clic/clac Chromé avec clapet en céramique Universal-Ablaufgarnitur Click-Clack Chrom mit Keramikstopfen Универсальный донный клапан click/clack хром с керамической крышкой</p>	PIL01(X)*	0,40	 <b>Gloss White</b>	<b>95,00</b>
			 *X = N - <b>Gloss Black</b>	<b>114,00</b>
			 <b>Le Terre di Cielo</b>	<b>139,00</b>
			 <b>Le Acque di Cielo</b>	<b>139,00</b>
			 <b>Gloss White</b>	<b>120,00</b>
 <p><b>Universal click/clack drain in BLACK MATT finish with ceramic lid</b> Válvula universal click/clack Negro Matt con tapa en cerámica Bonde universelle clic/clac Noir Mat avec clapet en céramique Universal-Ablaufgarnitur Click-Clack Matt Schwarz mit Keramikstopfen Универсальный донный клапан click/clack черный матовый с керамической крышкой</p>	PIL01NM(X)*	0,40	 *X = N - <b>Gloss Black</b>	<b>159,00</b>
			 <b>Le Terre di Cielo</b>	<b>169,00</b>
			 <b>Le Acque di Cielo</b>	<b>169,00</b>
			 <b>Gloss White</b>	<b>120,00</b>
			 *X = N - <b>Gloss Black</b>	<b>159,00</b>
 <p><b>Universal click/clack drain in CEMENTO finish with ceramic lid</b> Válvula universal click/clack Cemento con tapa en cerámica Bonde universelle clic/clac Cemento avec clapet en céramique Universal-Ablaufgarnitur Click-Clack Cement mit Keramikstopfen Универсальный донный Cemento click/clack с керамической крышкой</p>	PIL01CM(X)*	0,40	 <b>Le Terre di Cielo</b>	<b>169,00</b>
			 <b>Le Acque di Cielo</b>	<b>169,00</b>
			 <b>Gloss White</b>	<b>120,00</b>
			 *X = N - <b>Gloss Black</b>	<b>159,00</b>
			 <b>Le Terre di Cielo</b>	<b>169,00</b>
 <p><b>Universal click/clack drain in BRONZE with ceramic lid</b> Válvula universal click/clack Bronce con tapa en cerámica Bonde universelle clic/clac Bronze avec clapet en céramique Universal-Ablaufgarnitur Click-Clack Bronze mit Keramikstopfen Универсальный донный клапан click/clack бронза с керамической крышкой</p>	PIL01BR(X)*	0,40	 <b>Le Terre di Cielo</b>	<b>182,00</b>
			 <b>Le Acque di Cielo</b>	<b>182,00</b>
			 <b>Gloss White</b>	<b>135,00</b>
			 *X = N - <b>Gloss Black</b>	<b>171,00</b>
			 <b>Le Terre di Cielo</b>	<b>182,00</b>
 <p><b>CHROMED siphon</b> Sifone Cromado \ Siphon Chromé \ Siphon Verchromt \ сифон Chrome</p>	SISP	0,93	 <b>Chrome</b>	<b>133,00</b>
 <p><b>MATT BLACK siphon</b> Sifone Negro Mate \ Siphon Noir Mat \ Siphon Schwarz Matt \ Сифон Черный матовый</p>	SIFN	0,93	 <b>Matt Black</b>	<b>194,00</b>
 <p><b>CEMENTO siphon</b> Sifone Cemento \ Siphon Cemento \ Siphon Cemento \ сифон Cemento</p>	SIFCM	0,93	 <b>Cemento</b>	<b>194,00</b>
 <p><b>BRONZE siphon</b> Sifone Bronce \ Siphon Bronce \ Siphon Bronze \ бронза сифон</p>	SIFBR	0,93	 <b>Bronze</b>	<b>220,00</b>







Le Terre di Cielo	 TL - Talco	 PM - Pomice	 BR - Brina	 BA - Basalto	 LV - Lavagna	 CM - Cemento	 FN - Fango	 CA - Cacao
	 AN - Arenaria	 AV - Avena	 LN - Lino	 AG - Agave	 MU - Muschio	 PL - Polvere	 CP - Cipria	 CN - Canapa
Le Acque di Cielo	 OL - Oltremare	 SM - Smeraldo	 AL - Alga	 CO - Corallo	 NI - Ninfea	 AM - Anemone		

## Technical symbols legend

Simbolos técnicos clave / Légende symboles techniques / Technische Zeichenerklärung / Перечень технических символов







 <p><b>one side is unglazed</b> con un lado sin esmaltar avec un côté non émaillé eine Seite unglasiert одна сторона не покрыта эмалью</p>	 <p><b>all sides are enamelled</b> con todos los lados esmaltados avec tous les côtés émaillés alle Seiten glasiert все стороны покрыты эмалью</p>	 <p><b>with 1 hole prepared 3 holes</b> 1 agujero predispuesto 3 agujeros avec un trou predisposition à trois trous mit 1-Loch auf 3-Loch durchschlagbar одно отверстие с возможностью выполнения трех отверстий</p>	 <p><b>one tap hole</b> con 1 agujero monotrou 1-Loch одно отверстие под смеситель</p>	 <p><b>no tap hole on request</b> sin agujero, solo a petición sans orifice sur demande auf Anfrage ohne Loch без отверстия под смеситель по запросу</p>	 <p><b>without overflow</b> sin rebosadero sans trop-plein ohne Überlauf без слива-перелива</p>
 <p><b>on top installation</b> instalación de apoyo installation à partir du plan Montage auf Platte установка на столешницу</p>	 <p><b>wall-hung installation</b> instalación suspendida installation suspendue wandhängende Montage подвесная установка</p>	 <p><b>with fixing parts</b> fijaciones incluidas fixations incluses inklusive Befestigungen в комплекте с крепежами</p>	 <p><b>no tap holes</b> sin agujero para grifo sans orifice robinet ohne Hahnloch без отверстия под смеситель</p>	 <p><b>with overflow</b> con rebosadero avec trop-plein mit Überlauf с переливом</p>	



	Size (cm) Medidas Dimensions Maße Размеры	Product code Artículo Article Artikel Артикул	Net weight (Kg) Peso neto Poids net Reingewicht вес нетто	Finishes Acabados Finitions Farbe Отделки	Euro Евро	Pz. шт. pallet Italia	Pz. шт. pallet Cont.
<b>SENZA BRIDA \ RIMLESS</b>  <b>Wall-hung wc with fixing kit (4,5 LT) - rimless</b> Inodoro suspendido completo con fijaciones (4,5 LT) - <b>sin brida</b> / Cuvette suspendue avec fixations (4,5 LT) - <b>sans brida</b> / Wand-WC mit Befestigungsset (4,5 lt.) - <b>ohne Spülrand</b> / Подвесной унитаз в комплекте с крепежами (4,5 литр) - <b>без ободка</b>	37,5 x 55 x 37,5 h	SHCOVSK(X)*	27,75	● Gloss White ● *X = N - Gloss Black ● *X = TL - Talco ● Le Terre di Cielo	500,00 677,00 770,00 837,00	15	20
 <b>Wall-hung wc with fixing kit (4,5 LT)</b> Wc suspendido completo con fijaciones (4,5 LT) Wc suspendu avec fixation (4,5 LT) Wand-WC mit Befestigungsset (4,5 LT) Унитаз подвесной в комплекте со крепежами (4,5 LT)	37,5 x 55 x 37,5 h	SHCOVS(X)*	27,15	● Gloss White ● *X = N - Gloss Black ● *X = TL - Talco ● Le Terre di Cielo	500,00 677,00 770,00 837,00	15	20
 <b>Thermosetting seat &amp; cover</b> Asiento para inodoro Abattant thermodurcissable Wc-sitz thermodur Сиденье из термоотверждающейся смолы		CPVSHCOT	2,80	● Gloss White	110,00		
 <b>QUICK RELEASE HINGES</b> <b>Thermosetting slim double flap soft close seat &amp; cover with quick release hinges</b> Asiento para inodoro amortiguado bisagra con sistema extraíble Abattant thermodurcissable soft Wc-sitz thermodur mit Abs. Сиденье из термоотверждающейся смолы, с плавным опусканием		CPVSHCOTF(X)*	2,80	● Gloss White ● *X = N - Gloss Black ● *X = TL - Talco ● Le Terre di Cielo	204,00 294,00 332,00 345,00		
 <b>Impact and acoustic protection panel</b> Protección antigolpes y acústica / Protection acoustique et anti-choc / Stoss- und Schalldämmung / Противоударная и акустическая защита		PAA	0,16		17,00		
 <b>Couple of fixing brackets for wall-hung wc/bidet - Pareja de estribo para Inodoro/Bidet suspendido / Étriers de fixation pour Wc/Bidet suspendus / 1 Paar Halterungen für wandhängendes Wc/Bidet / Монтажная рама для подвесного унитаза/биде</b>	3,3 x 18,5 x 55 h	508	2,00		39,00		

























### Technical symbols legend

Simbolos técnicos clave / Légende symboles techniques / Technische Zeichenerklärung / Перечень технических символов

 <b>wall-hung installation</b> instalación suspendida installation suspendue wandhängende Montage подвесная установка	 <b>with fixing parts</b> fijaciones incluidas fixations incluses inklusive Befestigungen в комплекте с крепежами	 <b>Combifix compatibility</b> compatible Combifix mit Combifix kompatibel совместим с combifix	 <b>4,5 l toilet tank</b> descarga 4,5 lt évacuation à 4,5 l 4,5 l-Spülung бачок на 4,5 л	 <b>quick release hinges</b> sistema extraíble charnières à ouverture Takeoff Funktion быстрый съем	 <b>rimless</b> sin brida sans brida ohne Spülrand без ободка
---	--	---	--	--	--





\* Terre di Cielo finishes available for wc-bidet / Acabados Terre di Cielo disponibles para wc-bidet / Finitions Terre di Cielo disponibles pour cuvette-bidet / Für das WC/Bidet erhältliche Ausführungen Terre di Cielo / Отделку Terre di Cielo доступны для унитаза и биде

● TL - Talco ● PM - Pomice ● BR - Brina ● AN - Arenaria ● AV - Avena ● CM - Cemento ● BA - Basalto ● LV - Lavagna

	Size (cm)	Product code	Net weight(Kg)	Finishes	Euro	Pz.	Pz.
	Medidas Dimensions Maße Размеры	Artículo Article Article Артикул	Peso neto Poïds net Reingewicht вес нетто	Acabados Finitions Farbe Отделка	Евро	шт. pallet Italia	шт. pallet Cont.
 <p><b>Wall-hung one hole bidet with fixing kit</b> Bidé suspendido monoagujero completo con fijaciones Bidet suspendu monotrou avec fixation Wand-Bidet einloch mit Befestigungskit Биде подвесное с одним отверстием под смеситель, в комплекте с крепежами</p>	37,5 x 55 x 37,5 h	SHCOBS(X)*	23,50	<ul style="list-style-type: none"> <li> <b>Gloss White</b></li> <li> <b>*X = N - Gloss Black</b></li> <li> <b>*X = TL - Talco</b></li> <li> <b>Le Terre di Cielo*</b></li> </ul>	500,00 677,00 770,00 837,00	15	20
 <p><b>Impact and acoustic protection panel</b> Protección antigolpes y acústica / Protection acoustique et anti-choc / Stoss-und Schalldämmung / Противоударная и акустическая защита</p>		PAA	0,16		17,00		
 <p><b>Couple of fixing brackets for wall-hung wc/bidet</b> - Pareja de estribo para Inodoro/ Bidet suspendido / Étriers de fixation pour Wc/Bidet suspendus / 1 Paar Halterungen für wandhängendes Wc/Bidet / Монтажная рама для подвесного унитаза/ биде</p>	3,3 x 18,5 x 55 h	508	2,00		39,00		
 <p><b>Universal click/clack drain in CHROME with ceramic lid</b> Válvula universal click/clack Cromado con tapa en cerámica Bonde universelle clic/clac Chromé avec clapet en céramique Universal-Abflussgarnitur Click-Clack Chrom mit Keramikstopfen Универсальный донный клапан click/clack хром с керамической крышкой</p>		PIL01(X)*	0,40	<ul style="list-style-type: none"> <li> <b>Gloss White</b></li> <li> <b>*X = N - Gloss Black</b></li> <li> <b>Le Terre di Cielo</b></li> </ul>	95,00 114,00 139,00		
 <p><b>Universal click/clack drain in BLACK MATT finish with ceramic lid</b> / Válvula universal click/clack Negro Matt con tapa en cerámica / Bonde universelle clic/clac Noir Mat avec clapet en céramique Universal-Abflussgarnitur Click-Clack Matt Schwarz mit Keramikstopfen Универсальный донный клапан click/clack черный матовый с керамической крышкой</p>		PIL01NM(X)*	0,40	<ul style="list-style-type: none"> <li> <b>Gloss White</b></li> <li> <b>*X = N - Gloss Black</b></li> <li> <b>Le Terre di Cielo</b></li> </ul>	120,00 159,00 169,00		
 <p><b>Universal click/clack drain in CEMENTO finish with ceramic lid</b> Válvula universal click/clack Cemento con tapa en cerámica Bonde universelle clic/clac Cemento avec clapet en céramique Universal-Abflussgarnitur Click-Clack Cement mit Keramikstopfen Универсальный донный Cemento click/clack с керамической крышкой</p>		PIL01CM(X)*	0,40	<ul style="list-style-type: none"> <li> <b>Gloss White</b></li> <li> <b>*X = N - Gloss Black</b></li> <li> <b>Le Terre di Cielo</b></li> </ul>	120,00 159,00 169,00		
 <p><b>Universal click/clack drain in BRONZE with ceramic lid</b> Válvula universal click/clack Bronce con tapa en cerámica Bonde universelle clic/clac Bronze avec clapet en céramique Universal-Abflussgarnitur Click-Clack Bronze mit Keramikstopfen Универсальный донный клапан click/clack бронза с керамической крышкой</p>		PIL01BR(X)*	0,40	<ul style="list-style-type: none"> <li> <b>Gloss White</b></li> <li> <b>*X = N - Gloss Black</b></li> <li> <b>Le Terre di Cielo</b></li> </ul>	135,00 171,00 182,00		







## Technical symbols legend

Simbolos técnicos clave / Légende symboles techniques / Technische Zeichenerklärung / Перечень технических символов

 <p><b>one tap hole</b> con 1 agujero monotrou 1-Loch одно отверстие под смеситель</p>	 <p><b>with overflow</b> con rebosadero avec trop-plein mit Überlauf с переливом</p>	 <p><b>wall-hung installation</b> instalación suspendida installation suspendue wandhängende Montage подвесная установка</p>	 <p><b>with fixing parts</b> fijaciones incluidas fixations incluses inklusive Befestigungen в комплекте с крепежами</p>	 <p><b>Combifix compatibility</b> compatible Combifix mit Combifix kompatibel совместим с combifix</p>
--	---	---	---	---

\* Terre di Cielo finishes available for wc-bidet /  
Acabados Terre di Cielo disponibles para wc-bidet / Finitions  
Terre di Cielo disponibles pour cuvette-bidet / Für das WC/  
Bidet erhältliche Ausführungen Terre di Cielo / Отделка  
Terre di Cielo доступны для унитаза и биде

 TL - Talco  PM - Pomice  BR - Brina  AN - Arenaria  AV - Avena  CM - Cemento  BA - Basalto  LV - Lavagna

 <b>Back-to-wall WC with adjustable water inlet/outlet (4,5 LT) - rimless</b> Inodoro a suelo bifuncional con salida a distancia especial (4,5 LT) - <b>sin brida</b> Vase au sol bifonctionnel avec raccord de la décharge allongé (4,5 LT) - <b>sans bride</b> Bodenstehendes WC (bifunktional mit einstellbarem Ablauf) (4,5 Lt) - <b>ohne Spülrand</b> Бифункциональный напольный унитаз с адаптируемым выпуском		<b>Size (cm)</b> Medidas Dimensions Maße Размеры	<b>Product code</b> Artículo Article Artikel Артикул	<b>Net weight(Kg)</b> Peso neto Poids net Reingewicht вес нетто	<b>Finishes</b> Acabados Finitions Farbe Отделки	<b>Euro</b> Евро	<b>Pz.</b> шт. pallet Italia	<b>Pz.</b> шт. pallet Cont.
	<b>38 x 55 x 44 h</b> <b>SHCOVAKTR(X)*</b> 33,00 ● <b>Gloss White</b> <b>477,00</b> ● <b>*X = N - Gloss Black</b> <b>677,00</b> ● <b>*X = TL - Talco</b> <b>791,00</b> ● <b>Le Terre di Cielo*</b> <b>850,00</b>							15
 <b>Thermosetting seat &amp; cover</b> Asiento para inodoro Abattant thermodurcissable Wc-sitz thermodur Сиденье из термоотверждающейся смолы			<b>CPVSHCOT</b> 2,80 ● <b>Gloss White</b> <b>110,00</b>					
 <b>Thermosetting slim double flap soft close seat &amp; cover with quick release hinges</b> Asiento para inodoro amortiguado bisagra con sistema extraíble / Abattant thermodurcissable soft Wc-sitz thermodur mit Abs. / Сиденье из термоотверждающейся смолы, с плавным опусканием			<b>CPVSHCOTF(X)*</b> 2,80 ● <b>Gloss White</b> <b>204,00</b> ● <b>*X = N - Gloss Black</b> <b>294,00</b> ● <b>*X = TL - Talco</b> <b>332,00</b> ● <b>Le Terre di Cielo*</b> <b>345,00</b>					
 <b>Magic box for wc/bidet</b> Magic Box para inodoro/bidet Magic box pour cuvette/bidet Magic box für Wc/Bidet Magic Box для унитаза/биде		<b>41,5 x 12 x 80 h</b> <b>MABX(X)*</b> 17,50 ● <b>Gloss White</b> <b>250,00</b>					18	36

## Technical symbols legend



















Simbolos técnicos clave / Légende symboles techniques / Technische Zeichenerklärung / Перечень технических символов

 <b>bifunctional drain</b> descarga bifuncional évacuation bifonctionnelle Spülung mit zwei Montagevarianten функциональный бачок	 <b>back to wall installation</b> instalación a suelo installation à terre bodenstehende Montage напольная установка	 <b>with fixing parts</b> fijaciones incluidas fixations incluses inklusive Befestigungen в комплекте с крепежами	 <b>4,5 l toilet tank</b> descarga 4,3 lt évacuation à 4,5 l 4,5 l-Spülung бачок на 4,5 л	 <b>rimless</b> sin brida sans bride ohne Spülrand без ободка
--	---	---	--	--

\* Terre di Cielo finishes available for wc-bidet /  
 Acabados Terre di Cielo disponibles para wc-bidet / Finitions  
 Terre di Cielo disponibles pour cuvette-bidet / Für das WC/  
 Bidet erhältliche Ausführungen Terre di Cielo / Отделка  
 Terre di Cielo доступны для унитаза и биде

● TL - Talco ● PM - Pomice ● BR - Brina ● AN - Arenaria ● AV - Avena ● CM - Cemento ● BA - Basalto ● LV - Lavagna

	<b>Size (cm)</b> Medidas Dimensions Maße Размеры	<b>Product code</b> Artículo Article Artikel Артикул	<b>Net weight (Kg)</b> Peso neto Poids net Reingewicht вес нетто	<b>Finishes</b> Acabados Finitions Farbe Отделки	<b>Euro</b> Евро	<b>Pz.</b> шт. pallet Italia	<b>Pz.</b> шт. pallet Cont.
<p><b>Technical curve "floor trap" for toilet.</b>                      Curva técnica "salida vertical" para inodoro.                      Courbe technique à S pour cuvette avec sortie au sol.                      WC-Ablaufbogen "S".                      Колено "S"-образное для унитаза.</p>		<p>CSB</p>	<p>0,40</p>		<p>18,00</p>		
<p><b>90° technical curve.</b>                      Curva de técnica a noventa grados.                      Pipe d'évacuation à 90°.                      WC-Aublaufbogen 90 Grad.                      Колено 90° регулируемое .</p>		<p>CSR90</p>	<p>0,75</p>		<p>19,00</p>		
<p><b>PVC pipe for adjustable water outlet WC.</b>                      Curva técnica para inodoro con salida a distancia especial.                      Courbe technique pour vase avec raccord décharge.                      Technischer Bogen zum WC mit einstellbaren Ablauf.                      Колено для унитаза со сливом в пол.</p>		<p>CSTR</p>	<p>0,75</p>		<p>41,00</p>		
<p><b>Straight pan connector for wall trap</b>                      Anclaje a pared para inodoro                      Pipe pour sortie horizontale                      WC-Anschlussstutzen für Abgang waagerecht                      Фитинг для выпуска в стену для унитаза</p>		<p>RPB</p>	<p>0,35</p>		<p>15,00</p>		
<p><b>Eccentric pipe for water outlet up to ± 1,5 cm.</b>                      Tubo buque trasero excéntrico máximo ± 1,5 cm.                      Pipe de raccordement d'évacuation WC excentré max ± 1,50 cm.                      WC-Abgangstutzen mit Excenter (max ± 1,5 cm).                      Патрубок для унитаза эксцентрический макс. ± 1,5 см.</p>		<p>RSE</p>	<p>0,10</p>		<p>15,00</p>		

		Size (cm)	Product code	Net weight(Kg)	Finishes	Euro	Pz.	Pz.
		Medidas Dimensions Maße Размеры	Artículo Article Artikel Артикул	Peso neto Poids net Reingewicht вес нетто	Acabados Finitions Farbe Отделки	Евро	шт. pallet Italia	шт. pallet Cont.
 <p><b>Wc with horizontal outlet convertible to floor outlet by technical curve (4,5 LT)</b> Wc con desagüe a pared convertible a suelo con curva técnica (4,5 LT) / Wc avec évacuation murale transformable à terre avec courbe technique (4,5l) / WC mit Wandabfluss, durch Kurventechnik auf Bodenabfluss umrüstbar (4,5 LT) / Слив в стену при помощи технического колена трансформируется на слив в пол (4,5 л)</p>		38 x 55 x 44 h	SHCOVA(X)*	30,80	<ul style="list-style-type: none"> <li> <b>Gloss White</b></li> <li> <b>*X = N - Gloss Black</b></li> <li> <b>*X = TL - Talco</b></li> <li> <b>Le Terre di Cielo*</b></li> </ul>	477,00 677,00 771,00 838,00	15	20
 <p><b>Thermosetting seat &amp; cover</b> Asiento para inodoro / Abattant thermodurcissable Wc-sitz thermotur / Сиденье из термоотверждающейся смолы</p>			CPVSHCOT	2,80	<ul style="list-style-type: none"> <li> <b>Gloss White</b></li> </ul>	110,00		
 <p><b>QUICK RELEASE HINGES</b> </p> <p><b>Thermosetting slim double flap soft close seat &amp; cover with quick release hinges</b> Asiento para inodoro amortiguado bisagra con sistema extraíble / Abattant thermodurcissable soft Wc-sitz thermotur mit Abs. / Сиденье из термоотверждающейся смолы, с плавным опусканием</p>			CPVSHCOTF(X)*	2,80	<ul style="list-style-type: none"> <li> <b>Gloss White</b></li> <li> <b>*X = N - Gloss Black</b></li> <li> <b>*X = TL - Talco</b></li> <li> <b>Le Terre di Cielo*</b></li> </ul>	204,00 294,00 332,00 345,00		
 <p><b>Magic box for wc/bidet</b> Magic Box para inodoro/bidet / Magic box pour cuvette/ bidet / Magic box für Wc/Bidet / Magic Box для унитаза/биде</p>		41,5 x 12 x 80 h	MABX(X)*	17,50	<ul style="list-style-type: none"> <li> <b>Gloss White</b></li> </ul>	250,00	18	36
 <p><b>Technical curve "floor trap" for toilet</b> Curva técnica "salida vertical" para inodoro / Courbe technique à S pour cuvette avec sortie au sol / WC-Ablaufbogen "S" / олено "S"-образное для унитазов, регулируемое</p>			CSB	0,40		18,00		
 <p><b>Straight pan connector for wall trap</b> Anclaje a pared para inodoro / Pipe pour sortie horizontale / WC-Anschlussstutzen für Abgang waagerecht / Фитинг для выпуска в стену для унитазов</p>			RPB	0,35		15,00		

























### Technical symbols legend

Simbolos técnicos clave / Légende symboles techniques / Technische Zeichenerklärung / Перечень технических символов

 <p><b>bifunctional drain</b> descarga bifuncional évacuation bifonctionnelle Spülung mit zwei Montagevarianten функциональный бачок</p>	 <p><b>back to wall installation</b> instalación a suelo installation à terre bodenstehende Montage напольная установка</p>	 <p><b>with fixing parts</b> fijaciones incluidas fixations incluses inklusive Befestigungen в комплекте с крепежами</p>	 <p><b>4,5 l toilet tank</b> descarga 4,5 l évacuation à 4,5 l 4,5 l-Spülung бачок на 4,5 л</p>	 <p><b>quick release hinges</b> sistema extraíble charnières à ouverture Takeoff Funktion быстрый съем</p>
--	--	---	--	---

\* Terre di Cielo finishes available for wc-bidet /  
Acabados Terre di Cielo disponibles para wc-bidet / Finitions  
Terre di Cielo disponibles pour cuvette-bidet / Für das WC/  
Bidet erhältliche Ausführungen Terre di Cielo / Отделка  
Terre di Cielo доступны для унитаза и биде

TL - Talco ● PM - Pomice ● BR - Brina ● AN - Arenaria ● AV - Avena ● CM - Cemento ● BA - Basalto ● LV - Lavagna

	Size (cm)	Product code	Net weight (Kg)	Finishes	Euro	Pz.	Pz.
	Medidas Dimensions Maße Размеры	Artículo Article Artikel Артикул	Peso neto Poïds net Reingewicht вес нетто	Acabados Finitions Farbe Отделки	Евро	шт. pallet Italia	шт. pallet Cont.
 <p><b>Back to wall one hole bidet</b> Bidé a suelo monoagujero Bidet monotrou Stand-Bidet einloch Биде напольное с одним отверстием под смесителем</p>	38 x 55 x 44 h	SHCOBI(x)*	27,40	<ul style="list-style-type: none"> <li> <b>Gloss White</b></li> <li> <b>*X = N - Gloss Black</b></li> <li> <b>*X = TL - Talco</b></li> <li> <b>Le Terre di Cielo*</b></li> </ul>	477,00 677,00 771,00 838,00	15	20
 <p><b>Magic box for wc/bidet</b> Magic Box para inodoro/bidet Magic box pour cuvette/bidet Magic box für Wc/Bidet Magic Box для унитаза/биде</p>	41,5 x 12 x 80 h	MABX(x)*	17,50	<ul style="list-style-type: none"> <li> <b>Gloss White</b></li> </ul>	250,00	18	36
 <p><b>Universal click/clack drain in CHROME with ceramic lid</b> Válvula universal click/clack Cromado con tapa en cerámica Bonde universelle clic/clac Chromé avec clapet en céramique Universal-Abflussgarnitur Click-Clack Chrom mit Keramikstopfen Универсальный донный клапан click/clack хром с керамической крышкой</p>		PIL01(x)*	0,40	<ul style="list-style-type: none"> <li> <b>Gloss White</b></li> <li> <b>*X = N - Gloss Black</b></li> <li> <b>Le Terre di Cielo</b></li> </ul>	95,00 114,00 139,00		
 <p><b>Universal click/clack drain in BLACK MATT finish with ceramic lid</b> / Válvula universal click/clack Negro Matt con tapa en cerámica / Bonde universelle clic/clac Noir Mat avec clapet en céramique Universal-Abflussgarnitur Click-Clack Matt Schwarz mit Keramikstopfen Универсальный донный клапан click/clack черный матовый с керамической крышкой</p>		PIL01NM(x)*	0,40	<ul style="list-style-type: none"> <li> <b>Gloss White</b></li> <li> <b>*X = N - Gloss Black</b></li> <li> <b>Le Terre di Cielo</b></li> </ul>	120,00 159,00 169,00		
 <p><b>Universal click/clack drain in CEMENTO finish with ceramic lid</b> Válvula universal click/clack Cemento con tapa en cerámica Bonde universelle clic/clac Cemento avec clapet en céramique Universal-Abflussgarnitur Click-Clack Cement mit Keramikstopfen Универсальный донный Cemento click/clack с керамической крышкой</p>		PIL01CM(x)*	0,40	<ul style="list-style-type: none"> <li> <b>Gloss White</b></li> <li> <b>*X = N - Gloss Black</b></li> <li> <b>Le Terre di Cielo</b></li> </ul>	120,00 159,00 169,00		
 <p><b>Universal click/clack drain in BRONZE with ceramic lid</b> Válvula universal click/clack Bronce con tapa en cerámica Bonde universelle clic/clac Bronze avec clapet en céramique Universal-Abflussgarnitur Click-Clack Bronze mit Keramikstopfen Универсальный донный клапан click/clack бронза с керамической крышкой</p>		PIL01BR(x)*	0,40	<ul style="list-style-type: none"> <li> <b>Gloss White</b></li> <li> <b>*X = N - Gloss Black</b></li> <li> <b>Le Terre di Cielo</b></li> </ul>	135,00 171,00 182,00		

## Technical symbols legend



Simbolos técnicos clave / Légende symboles techniques / Technische Zeichenerklärung / Перечень технических символов

 <p><b>one tap hole</b> con 1 agujero monotrou 1-Loch одно отверстие под смеситель</p>	 <p><b>with overflow</b> con rebosadero avec trop-plein mit Überlauf с переливом</p>	 <p><b>quick release hinges</b> sistema extraible charnières à ouverture Takeoff Funktion быстрый съем</p>	 <p><b>with fixing parts</b> fijaciones incluidas fixations incluses inklusive Befestigungen в комплекте с крепёжами</p>
--	---	---	---

\* Terre di Cielo finishes available for wc-bidet /  
Acabados Terre di Cielo disponibles para wc-bidet / Finitions  
Terre di Cielo disponibles pour cuvette-bidet / Für das WC/  
Bidet erhältliche Ausführungen Terre di Cielo / Отделка  
Terre di Cielo доступны для унитаза и биде

● TL - Talco ● PM - Pomice ● BR - Brina ● AN - Arenaria ● AV - Avena ● CM - Cemento ● BA - Basalto ● LV - Lavagna

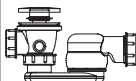

 	Size (cm)	Product code	Net weight (Kg)	Finishes	Euro	Pz.	Pz.
	Medidas Dimensions Maße Размеры	Artículo Article Artikel Артикул	Peso neto Poids net Reingewicht вес нетто	Acabados Finitions Farbe Отделки	Евро	шт. pallet Italia	шт. pallet Cont.
 <p><b>Shui Comfort LivingTec bath tub</b>                      Bañera Shui Comfort de LivingTec                      Baignoire Shui Comfort in LivingTec                      Shui Comfort Badewanne aus livingtec                      ванна Shui comfort LivingTec</p>	87 x 170 x 53 h	SHCOBAT	110,00	<ul style="list-style-type: none"> <li><span style="display: inline-block; width: 10px; height: 10px; background-color: #e0e0e0; border-radius: 50%; margin-right: 5px;"></span> <b>Matt White</b></li> <li><span style="display: inline-block; width: 10px; height: 10px; background-color: #444; border-radius: 50%; margin-right: 5px;"></span> <b>Brina</b></li> <li><span style="display: inline-block; width: 10px; height: 10px; background-color: #808080; border-radius: 50%; margin-right: 5px;"></span> <b>Arenaria</b></li> </ul>	<p><b>4872,00</b></p> <p><b>6497,00</b></p> <p><b>6497,00</b></p>		
<p><b>Bathtub waste for Shui Comfort (mandatory)</b>                      Sistema de descarga para bañera Shui Comfort (obligatorio)                      Système de chasse pour baignoire Shui Comfort (nécessaire)                      Ablaufgarnitur für Badewanne Shui Comfort (geböten)                      Выхлопная система для ванна Shui comfort (обязательный)</p>		SHCOMEC	0,40		<b>131,00</b>		

## Technical symbols legend

Simbolos técnicos clave | Légende symboles techniques | Technische Zeichenerklärung | Перечень технических символов

 **with overflow**  
 con rebosadero  
 avec trop-plein  
 mit Überlauf  
 с переливом

 **room centre freestanding installation**  
 instalación freestanding centro habitación  
 installation autoportante centre pièce  
 freistehende Montage in der Raummitte  
 свободностоящая установка по центру комнаты



## Washbasins finishes

Acabados de Lavabos  
Finitions des Lavabos  
Waschbecken Farbe  
Отделки Раковина

- Gloss White
- N - Gloss Black

### Le Terre di Cielo

- TL - Talco
- PM - Pomice
- BR - Brina
- CM - Cemento
- BA - Basalto
- LV - Lavagna
- FN - Fango
- CA - Cacao
- AN - Arenaria
- AV - Avena
- MU - Muschio
- AG - Agave
- LN - Lino
- CN - Canapa
- CP - Cipria
- PL - Polvere

### Le Pietre

[SHBA40 - SHBA45]

- CS - Carrara Statuario
- BC - Breccia Arabescata
- GS - Grey Stone
- BP - Breccia Paradiso
- NQ - Nero Marquina

### Le Acque di Cielo

[SHBA40-SHBA45]

- OL - Oltremare
- SM - Smeraldo
- AL - Alga
- CO - Corallo
- NI - Ninfea
- AM - Anemone

## Washbasins finishes (SHLS66)

Acabados de Lavabos (SHLS66)  
Finitions des Lavabos (SHLS66)  
Waschbecken Farbe (SHLS66)  
Отделки Раковина (SHLS66)

- Gloss White

## WC and Bidets finishes

Acabados de Sanitarios  
Finitions des WC et Bidets  
WC und Bidet Farbe  
Отделки Унитаз и Биде

- Gloss White
- N - Gloss Black
- TL - Talco

### Le Terre di Cielo

- PM - Pomice
- BR - Brina
- AV - Avena
- AN - Arenaria
- CM - Cemento
- BA - Basalto

The possible variations of the colour cannot be considered as defect, but as a guarantee of the completely artisan manufacturing of this unique and high quality product.

Las variaciones de colores no se consideran un defecto sino una garantía de una elaboración manual y artesanal en un producto único y de calidad.

Les éventuelles variations de couleur ne peuvent être considérées comme des défauts, elles témoignent en revanche d'une méthode de travail totalement manuelle et artisanale employée pour obtenir un produit fini unique et de qualité.

Eventuelle Farbvariationen sind nicht als Mangel anzusehen, sondern als Garantie für die komplett handwerkliche Anfertigung eines einzigartigen und hochqualitativen Produkts.

Возможные вариации цвета не могут считаться дефектом, а являются подтверждением ручной работы, гарантией качества и уникальности изделия.

## Lavabi / washbasins



**SHBA40**  
ø40 x 18,5 h  
pag. 448



**SHBA**  
ø42 x 16,5 h  
pag. 448

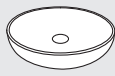

**SHBA45**  
ø45 x 12,5 h  
pag. 448

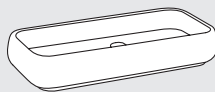

**SHLAA80**  
80 x 40 x 15 h  
pag. 448

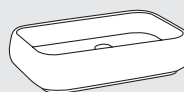

**SHLAA60**  
60 x 40 x 15 h  
pag. 448

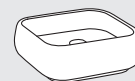

**SHLAA40**  
40 x 40 x 15 h  
pag. 448



**SHFREEC**  
40 x 40 x 85 h  
pag. 451

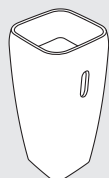

**SHFREEP**  
40 x 40 x 85 h  
pag. 451

## installazione sospesa o da piano wall-hung or on top installation

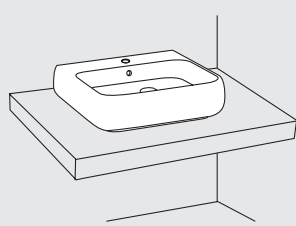
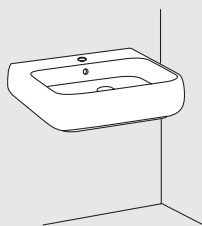

**SHLS66**  
66 x 48,5 x 15 h  
pag. 450

## Wc - bidet

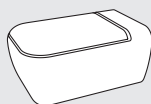

**SHVSB**  
36 x 55 x 29 h  
pag. 452

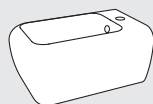

**SHBSB**  
36 x 55 x 29 h  
pag. 453

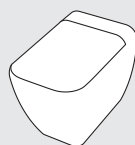

**SHVA**  
36 x 55 x 43 h  
pag. 454

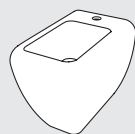

**SHBI**  
36 x 55 x 43 h  
pag. 455

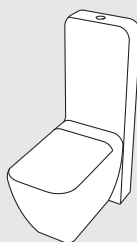

**SHVA + SHCM**  
36 x 69 x 98 h  
pag. 456

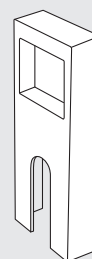



























**MABX**  
41,5 x 12 x 80 h  
pag. 454









	Size (cm)	Product code	Net weight (Kg)	Finishes	Euro	Pz.	Pz.
	Medidas Dimensions Maße Размеры	Artículo Article Artikel Артикул	Peso neto Poïds net Reingewicht вЕС НЕТТО	Acabados Finitions Farbe Отделки	Евро	шт. pallet Italia	шт. pallet Cont.
 <p><b>On top bowl with overflow</b> Cubela de apoyo con demasiado lleno Vasque à poser avec trop plein Aufsatzbecken mit Überlaufschutz Накладная чаша с переливом</p>	ø42 x 16,5 h	SHBA(X)*	9,20	<ul style="list-style-type: none"> <li> Gloss White</li> <li> *X = N - Gloss Black</li> <li> Le Terre di Cielo</li> </ul>	326,00 445,00 570,00	28	56
 <p><b>On top bowl without overflow ø40</b> Cubela de apoyo sin demasiado lleno ø40 Vasque à poser sans trop plein ø40 Aufsatzbecken ohne Überlauf ø40 Накладная чаша без переливом ø40</p>	ø40 x 18,5 h	SHBA40(X)*	8,55	<ul style="list-style-type: none"> <li> Gloss White</li> <li> *X = N - Gloss Black</li> <li> Le Terre di Cielo</li> <li> Le Acque di Cielo</li> <li> Le Pietre</li> </ul>	427,00 521,00 708,00 708,00 1076,00	26	52
 <p><b>On top bowl without overflow ø45</b> Cubela de apoyo sin demasiado lleno ø45 Vasque à poser sans trop plein ø45 Aufsatzbecken ohne Überlauf ø45 Накладная чаша без переливом ø45</p>	ø45 x 12,5 h	SHBA45(X)*	9,05	<ul style="list-style-type: none"> <li> Gloss White</li> <li> *X = N - Gloss Black</li> <li> Le Terre di Cielo</li> <li> Le Acque di Cielo</li> <li> Le Pietre</li> </ul>	433,00 532,00 744,00 744,00 1063,00	32	64
 <p><b>Rectangular on top washbasin</b> Lavabo sobre encimera rectangular 80 Lavabo rectangulaire à poser Aufsatzbecken rechteckig Раковина накладная прямоугольная</p>	80 x 40 x 15 h	SHLAA80(X)*	20,05	<ul style="list-style-type: none"> <li> Gloss White</li> <li> *X = N - Gloss Black</li> <li> Le Terre di Cielo</li> </ul>	447,00 656,00 733,00	14	28
	60 x 40 x 15 h	SHLAA60(X)*	14,45	<ul style="list-style-type: none"> <li> Gloss White</li> <li> *X = N - Gloss Black</li> <li> Le Terre di Cielo</li> </ul>	368,00 498,00 582,00	20	40
	40 x 40 x 15 h	SHLAA40(X)*	11,00	<ul style="list-style-type: none"> <li> Gloss White</li> <li> *X = N - Gloss Black</li> <li> Le Terre di Cielo</li> </ul>	266,00 371,00 460,00	26	52

## Technical symbols legend

Simbolos técnicos clave / Légende symboles techniques / Technische Zeichenerklärung / Перечень технических символов

































 all sides are enamelled  
con todos los lados esmaltados  
avec tous les côtés émaillés  
alle Seiten glasiert  
все стороны покрыты эмалью

 no tap holes  
sin agujero para  
grifo  
sans orifice robinet  
ohne Hahnloch  
без отверстия под  
смеситель



















 with overflow  
con rebosadero  
avec trop-plein  
mit Überlauf  
с переливом

 without overflow  
sin rebosadero  
sans trop-plein  
ohne Überlauf  
без слива-перелива

 on top installation  
instalación de apoyo  
installation à partir du plan  
Montage auf Platte  
установка на столешницу

	<b>Product code</b> Artículo Article Artikel Артикул	<b>Net weight</b> (Kg) Peso neto Poids net Reingewicht вес нетто	<b>Finishes</b> Acabados Finitions Farbe Отделки	<b>Euro</b> Евро
 <p><b>Universal click/clack drain in CHROME with ceramic lid</b> Válvula universal click/clack Cromado con tapa en cerámica Bonde universelle clic/clac Chromé avec clapet en céramique Universal-Ablaufgarnitur Click-Clack Chrom mit Keramikstopfen Универсальный донный клапан click/clack хром с керамической крышкой</p>	PIL01(X)*	0,40	<ul style="list-style-type: none"> <li> <b>Gloss White</b></li> <li> *X = N - <b>Gloss Black</b></li> <li> <b>Le Terre di Cielo</b></li> <li> <b>Le Pietre</b></li> <li> <b>Le Acque di Cielo</b></li> </ul>	<p>95,00</p> <p>114,00</p> <p>139,00</p> <p>148,00</p> <p>139,00</p>
 <p><b>Universal click/clack drain in BLACK MATT finish with ceramic lid</b> Válvula universal click/clack Negro Matt con tapa en cerámica Bonde universelle clic/clac Noir Mat avec clapet en céramique Universal-Ablaufgarnitur Click-Clack Matt Schwarz mit Keramikstopfen Универсальный донный клапан click/clack черный матовый с керамической крышкой</p>	PIL01NM(X)*	0,40	<ul style="list-style-type: none"> <li> <b>Gloss White</b></li> <li> *X = N - <b>Gloss Black</b></li> <li> <b>Le Terre di Cielo</b></li> <li> <b>Le Pietre</b></li> <li> <b>Le Acque di Cielo</b></li> </ul>	<p>120,00</p> <p>159,00</p> <p>169,00</p> <p>185,00</p> <p>169,00</p>
 <p><b>Universal click/clack drain in CEMENTO finish with ceramic lid</b> Válvula universal click/clack Cemento con tapa en cerámica Bonde universelle clic/clac Cemento avec clapet en céramique Universal-Ablaufgarnitur Click-Clack Cement mit Keramikstopfen Универсальный донный Cemento click/clack с керамической крышкой</p>	PIL01CM(X)*	0,40	<ul style="list-style-type: none"> <li> <b>Gloss White</b></li> <li> *X = N - <b>Gloss Black</b></li> <li> <b>Le Terre di Cielo</b></li> <li> <b>Le Pietre</b></li> <li> <b>Le Acque di Cielo</b></li> </ul>	<p>120,00</p> <p>159,00</p> <p>169,00</p> <p>185,00</p> <p>169,00</p>
 <p><b>Universal click/clack drain in BRONZE with ceramic lid</b> Válvula universal click/clack Bronce con tapa en cerámica Bonde universelle clic/clac Bronze avec clapet en céramique Universal-Ablaufgarnitur Click-Clack Bronze mit Keramikstopfen Универсальный донный клапан click/clack бронза с керамической крышкой</p>	PIL01BR(X)*	0,40	<ul style="list-style-type: none"> <li> <b>Gloss White</b></li> <li> *X = N - <b>Gloss Black</b></li> <li> <b>Le Terre di Cielo</b></li> <li> <b>Le Pietre</b></li> <li> <b>Le Acque di Cielo</b></li> </ul>	<p>135,00</p> <p>171,00</p> <p>182,00</p> <p>185,00</p> <p>182,00</p>
 <p><b>CHROMED siphon</b> Sifone Cromado \ Siphon Chromé \ Siphon Verchromt \ сифон Chrome</p>	SISP	0,93	 <b>Chrome</b>	133,00
 <p><b>MATT BLACK siphon</b> Sifone Negro Mate \ Siphon Noir Mat \ Siphon Schwarz Matt \ Сифон Черный матовый</p>	SIFN	0,93	 <b>Matt Black</b>	194,00
 <p><b>CEMENTO siphon</b> Sifone Cemento \ Siphon Cemento \ Siphon Cemento \ сифон Cemento</p>	SIFCM	0,93	 <b>Cemento</b>	194,00
 <p><b>BRONZE siphon</b> Sifone Bronce \ Siphon Bronze \ Siphon Bronze \ бронза сифон</p>	SIFBR	0,93	 <b>Bronze</b>	220,00

Le Terre di Cielo	 TL - Talco	 PM - Pomice	 BR - Brina	 BA - Basalto	 LV - Lavagna	 CM - Cemento	 FN - Fango	 CA - Cacao
	 AN - Arenaria	 AV - Avena	 LN - Lino	 AG - Agave	 MU - Muschio	 PL - Polvere	 CP - Cipria	 CN - Canapa
Le Acque di Cielo	 OL - Oltremare	 SM - Smeraldo	 AL - Alga	 CO - Corallo	 NI - Ninfea	 AM - Anemone		
Le Pietre	 CS - Carrara Statuario	 BC - Breccia Arabescata	 GS - Grey Stone	 BP - Breccia Paradiso	 NQ - Nero Marquina			

 	<b>Size (cm)</b> Medidas Dimensions Maße Размеры	<b>Product code</b> Artículo Article Artikel Артикул	<b>Net weight (Kg)</b> Peso neto Poids net Reingewicht вес нетто	<b>Finishes</b> Acabados Finitions Farbe Отделки	<b>Euro</b> Евро	<b>Pz.</b> шт. pallet Italia	<b>Pz.</b> шт. pallet Cont.
<b>Wall-hung or on top washbasin</b> Lavabo suspendido o de apoyo \ Lavabo suspendu ou à poser \ Waschtisch hängender oder Aufsatz Installation Раковина с одним отверстием под смеситель, подвесная или накладная установка <b>The washbasin is recommended for wall hung installation. For on top installation customers are advised to require the "RETTIFICA" option.</b> Se recomienda la instalación del lavabo suspendido. Para instalaciones de apoyo se aconseja usar la opción "RETTIFICA". La vasque est recommandée pour l'installation suspendu. Pour l'installation à poser on conseille l'option "RETTIFICA". Es empfiehlt sich, das Waschbecken hängend zu installieren. Bei Aufsatzmontage bitte die Option "RETTIFICA" anfragen. Данная раковина предназначена для подвесной установки. При установке на столешницу рекомендуется запросить опцию "RETTIFICA".	66 x 48,5 x 15 h	SHLS66(X)*	20,20	 <b>Gloss White</b>	<b>387,00</b>	20	34
		<b>RETTIFICA GRINDING РЕКТИФИКАЦИЯ</b>			<b>10,00</b>		
 <b>Universal click/clack drain in CHROME with ceramic lid</b> Válvula universal click/clack Cromado con tapa en cerámica Bonde universelle clic/clac Chromé avec clapet en céramique Universal-Abflussgarnitur Click-Clack Chrom mit Keramikstopfen Универсальный донный клапан click/clack хром с керамической крышкой		PIL01(X)*	0,40	 <b>Gloss White</b>	<b>95,00</b>		
 <b>Universal click/clack drain in BLACK MATT finish with ceramic lid</b> Válvula universal click/clack Negro Matt con tapa en cerámica Bonde universelle clic/clac Noir Mat avec clapet en céramique Universal-Abflussgarnitur Click-Clack Matt Schwarz mit Keramikstopfen Универсальный донный клапан click/clack черный матовый с керамической крышкой		PIL01NM(X)*	0,40	 <b>Gloss White</b>	<b>120,00</b>		
 <b>Universal click/clack drain in CEMENTO finish with ceramic lid</b> Válvula universal click/clack Cemento con tapa en cerámica Bonde universelle clic/clac Cemento avec clapet en céramique Universal-Abflussgarnitur Click-Clack Cement mit Keramikstopfen Универсальный донный Cemento click/clack с керамической крышкой		PIL01CM(X)*	0,40	 <b>Gloss White</b>	<b>120,00</b>		
 <b>Universal click/clack drain in BRONZE with ceramic lid</b> Válvula universal click/clack Bronce con tapa en cerámica Bonde universelle clic/clac Bronce avec clapet en céramique Universal-Abflussgarnitur Click-Clack Bronze mit Keramikstopfen Универсальный донный клапан click/clack бронза с керамической крышкой		PIL01BR(X)*	0,40	 <b>Gloss White</b>	<b>135,00</b>		
 <b>CHROMED siphon</b> Sifone Cromado \ Siphon Chromé \ Siphon Verchromt \ сифон Chrome		SISP	0,93	 <b>Chrome</b>	<b>133,00</b>		
 <b>MATT BLACK siphon</b> Sifone Negro Mate \ Siphon Noir Mat \ Siphon Schwarz Matt \ Сифон Черный матовый		SIFN	0,93	 <b>Matt Black</b>	<b>194,00</b>		
 <b>CEMENTO siphon</b> Sifone Cemento \ Siphon Cemento \ Siphon Cemento \ сифон Cemento		SIFCM	0,93	 <b>Cemento</b>	<b>194,00</b>		
 <b>BRONZE siphon</b> Sifone Bronce \ Siphon Bronze \ Siphon Bronze \ бронза сифон		SIFBR	0,93	 <b>Bronze</b>	<b>220,00</b>		

### Technical symbols legend

Símbolos técnicos clave | Légende symboles techniques | Technische Zeichenerklärung | Перечень технических символов

 **with overflow**  
 con rebosadero  
 avec trop-plein  
 mit Überlauf  
 с переливом

 **one side is unglazed**  
 con un lado sin esmaltar  
 avec un côté non émaillé  
 eine Seite unglasiert  
 одна сторона не покрыта эмалью

 **with 1 hole prepared 3 holes**  
 1 agujero predispuerto 3 agujeros  
 avec un trou prédisposition à trois trous  
 mit 1-Loch auf 3-Loch durchschlagbar  
 одно отверстие с возможностью выполнения трех отверстий

 **on top installation**  
 instalación de apoyo  
 installation à partir du plan  
 Montage auf Platte  
 установка на столешницу























 **wall-hung installation**  
 instalación suspendida  
 installation suspendue  
 wandhängende Montage  
 подвесная установка







 **with fixing parts**  
 fijaciones incluidas  
 fixations incluses  
 inklusive Befestigungen  
 в комплекте с крепежами

	Size (cm)	Product code	Net weight(Kg)	Finishes	Euro	Pz.	Pz.
	Medidas Dimensions Maße Размеры	Artículo Article Artikel Артикул	Peso neto Poids net Reingewicht вес нетто	Acabados Finitions Farbe Отделки	Евро	шт. pallet Italia	шт. pallet Cont.
 <p><b>Freestanding washbasin - room centre</b> Installation lavabo freestanding instalación en el centro del cuarto / Lavabo sur pied à installer en milieu de pièce Freistehender Säulenwaschtisch Montage in der Bad- Mitte Раковина отдельностоящая, установка по центру комнаты</p>	40 X 40 x 85 h	SHFREEC(X)*	44,45	<ul style="list-style-type: none"> <li> <b>Gloss White</b></li> <li> <b>*X = N - Gloss Black</b></li> <li> <b>Le Terre di Cielo</b></li> </ul>	<p>1691,00</p> <p>2308,00</p> <p>2703,00</p>	4	8
 <p><b>Freestanding washbasin - back to wall installation</b> Lavabo freestanding instalación a pared Lavabo sur pied à installer au mur Freistehender Säulenwaschtisch Montage an der Wand Раковина отдельностоящая, пристенная установка</p>	40 X 40 x 85 h	SHFREEP(X)*	43,85	<ul style="list-style-type: none"> <li> <b>Gloss White</b></li> <li> <b>*X = N - Gloss Black</b></li> <li> <b>Le Terre di Cielo</b></li> </ul>	<p>1691,00</p> <p>2308,00</p> <p>2703,00</p>	4	8
 <p><b>Universal click/clack drain in CHROME with ceramic lid</b> Válvula universal click/clack Cromado con tapa en cerámica Bonde universelle clic/clac Chromé avec clapet en céramique Universal-Abflussgarnitur Click-Clack Chrom mit Keramikstopfen Универсальный донный клапан click/clack хром с керамической крышкой</p>		PIL01(X)*	0,40	<ul style="list-style-type: none"> <li> <b>Gloss White</b></li> <li> <b>*X = N - Gloss Black</b></li> <li> <b>Le Terre di Cielo</b></li> </ul>	<p>95,00</p> <p>114,00</p> <p>139,00</p>		
 <p><b>Universal click/clack drain in BLACK MATT finish with ceramic lid</b> Válvula universal click/clack Negro Matt con tapa en cerámica Bonde universelle clic/clac Noir Mat avec clapet en céramique Universal-Abflussgarnitur Click-Clack Matt Schwarz mit Keramikstopfen Универсальный донный клапан click/clack черный матовый с керамической крышкой</p>		PIL01NM(X)*	0,40	<ul style="list-style-type: none"> <li> <b>Gloss White</b></li> <li> <b>*X = N - Gloss Black</b></li> <li> <b>Le Terre di Cielo</b></li> </ul>	<p>120,00</p> <p>159,00</p> <p>169,00</p>		
 <p><b>Universal click/clack drain in CEMENTO finish with ceramic lid</b> Válvula universal click/clack Cemento con tapa en cerámica Bonde universelle clic/clac Cimento avec clapet en céramique Universal-Abflussgarnitur Click-Clack Cement mit Keramikstopfen Универсальный донный Cemento click/clack с керамической крышкой</p>		PIL01CM(X)*	0,40	<ul style="list-style-type: none"> <li> <b>Gloss White</b></li> <li> <b>*X = N - Gloss Black</b></li> <li> <b>Le Terre di Cielo</b></li> </ul>	<p>120,00</p> <p>159,00</p> <p>169,00</p>		
 <p><b>Universal click/clack drain in BRONZE with ceramic lid</b> Válvula universal click/clack Bronce con tapa en cerámica Bonde universelle clic/clac Bronze avec clapet en céramique Universal-Abflussgarnitur Click-Clack Bronze mit Keramikstopfen Универсальный донный клапан click/clack бронза с керамической крышкой</p>		PIL01BR(X)*	0,40	<ul style="list-style-type: none"> <li> <b>Gloss White</b></li> <li> <b>*X = N - Gloss Black</b></li> <li> <b>Le Terre di Cielo</b></li> </ul>	<p>135,00</p> <p>171,00</p> <p>182,00</p>		

## Technical symbols legend

Simbolos técnicos clave | Légende symboles techniques | Technische Zeichenerklärung | Перечень технических символов

 <p><b>all sides are enamelled</b> con todos los lados esmaltados avec tous les côtés émaillés alle Seiten glasiert все стороны покрыты эмалью</p>	 <p><b>without overflow</b> sin rebosadero sans trop-plein ohne Überlauf без слива-перелива</p>	 <p><b>no tap holes</b> sin agujero para grifo sans orifice robinet ohne Hahnloch без отверстия под смеситель</p>	
 <p><b>back to wall freestanding installation</b> instalación freestanding a pared installation autoportante murale freistehende Montage an der Wand свободностоящая пристенная установка</p>	 <p><b>room centre freestanding installation</b> instalación freestanding centro habitación installation autoportante centre pièce freistehende Montage in der Raummitte свободностоящая установка по центру комнаты</p>	 <p><b>with fixing parts</b> fijaciones incluidas fixations incluses inklusive Befestigungen в комплекте с крепежами</p>	 <p><b>with technical joint or siphon</b> completo de curva/sifón fourni avec raccord courbé / siphon komplett mit Rohrbogen/ Siphon в комплекте с коленом / сифоном</p>
<p>Le Terre di Cielo</p> <ul style="list-style-type: none"> <li> TL - Talco</li> <li> PM - Pomice</li> <li> BR - Brina</li> <li> BA - Basalto</li> <li> LV - Lavagna</li> <li> CM - Cemento</li> <li> FN - Fango</li> <li> CA - Cacao</li> <li> AN - Arenaria</li> <li> AV - Avena</li> <li> LN - Lino</li> <li> AG - Agave</li> <li> MU - Muschio</li> <li> PL - Polvere</li> <li> CP - Cipria</li> <li> CN - Canapa</li> </ul>			

		Size (cm)	Product code	Net weight (kg)	Finishes	Euro	Pz.	Pz.
		Medidas Dimensions Maße Размеры	Artículo Article Artikel Артикул	Peso neto Poids net Reingewicht вес нетто	Acabados Finitions Farbe Отделки	Евро	шт. pallet Italia	шт. pallet Cont.
 <b>Wall-hung BIG wc with fixing kit (4,5 LT)</b> Wc suspendido <b>BIG</b> completo con fijaciones (4,5 LT) Wc suspendu <b>BIG</b> avec fixation (4,5 LT) Wand-WC mit Befestigungsset <b>BIG</b> (4,5 LT) Унитаз подвесной в комплекте с крепежами <b>BIG</b> (4,5 LT)		36 x 55 x 29 h	SHVSB(X)*	24,70	● Gloss White ● *X = N - Gloss Black ● *X = TL - Talco ● Le Terre di Cielo*	374,00 613,00 626,00 699,00	18	18
 <b>Thermosetting seat &amp; cover</b> Asiento para inodoro Abattant thermdurcissable Wc-sitz thermotur Сиденье из термоотверждающейся смолы			CPVSHT	2,40	● Gloss White	102,00		
 <b>Thermosetting soft close seat &amp; cover</b> Asiento para inodoro amortiguado Abattant thermdurcissable soft Wc-sitz thermotur mit Abs. Сиденье из термоотверждающейся смолы, с плавным опусканием			CPVSHTF(X)*	2,40	● Gloss White ● *X = N - Gloss Black ● *X = TL - Talco ● Le Terre di Cielo*	164,00 253,00 296,00 316,00		
 <b>Impact and acoustic protection panel</b> Protección antigolpes y acústica Protection acoustique et anti-choc Stoss-und Schalldämmung Противоударная и акустическая защита			PAA	0,16		17,00		
 <b>Couple of fixing brackets for wall-hung wc/bidet</b> Pareja de estribo para Inodoro/Bidet suspendido Étriers de fixation pour Wc/Bidet suspendus 1 Paar Halterungen für wandhängendes Wc/Bidet Монтажная рама для подвесного унитаза/биде		3,3 x 18,5 x 55 h	508	2,00		39,00		







### Technical symbols legend

Símbolos técnicos clave | Légende symboles techniques | Technische Zeichenerklärung | Перечень технических символов

 <b>wall-hung installation</b> instalación suspendida installation suspendue wandhängende Montage подвесная установка	 <b>with fixing parts</b> fijaciones incluidas fixations incluses inklusive Befestigungen в комплекте с крепежами	 <b>Combifix compatibility</b> compatible Combifix mit Combifix kompatibel совместим с combifix	 <b>4,5 l toilet tank</b> descarga 4,5 l évacuation à 4,5 l 4,5 l-Spülung бачок на 4,5 л
---	--	---	---

\* Terre di Cielo finishes available for wc-bidet /  
 Acabados Terre di Cielo disponibles para wc-bidet / Finitions  
 Terre di Cielo disponibles pour cuvette-bidet / Für das WC/  
 Bidet erhältliche Ausführungen Terre di Cielo / Отделка  
 Terre di Cielo доступны для унитаза и биде

● TL - Talco ● PM - Pomice ● BR - Brina ● AN - Arenaria ● AV - Avena ● CM - Cemento ● BA - Basalto

	<b>Size (cm)</b> Medidas Dimensions Maße Размеры	<b>Product code</b> Artículo Article Artikel Артикул	<b>Net weight(Kg)</b> Peso neto Poids net Reingewicht вес нетто	<b>Finishes</b> Acabados Finitions Farbe Отделки	<b>Euro</b> Евро	<b>Pz.</b> шт. pallet Italia	<b>Pz.</b> шт. pallet Cont.
<b>Wall-hung one hole BIG bidet with fixing kit</b> Bidé suspendido monoagujero <b>BIG</b> completo con fijaciones Bidet suspendu monotrou <b>BIG</b> avec fixation Wand-Bidet einloch mit Befestigungs <b>kit BIG</b> Биде подвесное с одним отверстием под смеситель, в комплекте с крепежами <b>BIG</b>	36 x 55 x 29 h	SHBSB(X)*	23,55	● Gloss White ● *X = N - Gloss Black ● *X = TL - Talco ● Le Terre di Cielo*	374,00 613,00 626,00 699,00	18	18
 <b>Impact and acoustic protection panel</b> Protección antigolpes y acústica / Protection acoustique et anti-choc / Stoss-und Schalldämmung / Противоударная и акустическая защита		PAA	0,16		17,00		
 <b>Couple of fixing brackets for wall-hung wc/bidet - Pareja de estribo para Inodoro/ Bidet suspendido / Étriers de fixation pour Wc/Bidet suspendus / 1 Paar Halterungen für wandhängendes Wc/Bidet / Монтажная рама для подвесного унитаза/ биде</b>	3,3 x 18,5 x 55 h	508	2,00		39,00		
 <b>Universal click/clack drain in CHROME with ceramic lid</b> Válvula universal click/clack Cromado con tapa en cerámica Bonde universelle clic/clac Chromé avec clapet en céramique Universal-Abflussgarnitur Click-Clack Chrom mit Keramikstopfen Универсальный донный клапан click/clack хром с керамической крышкой		PIL01(X)*	0,40	● Gloss White ● *X = N - Gloss Black ● Le Terre di Cielo	95,00 114,00 139,00		
 <b>Universal click/clack drain in BLACK MATT finish with ceramic lid</b> Válvula universal click/clack Negro Matt con tapa en cerámica Bonde universelle clic/clac Noir Mat avec clapet en céramique Universal-Abflussgarnitur Click-Clack Matt Schwarz mit Keramikstopfen Универсальный донный клапан click/clack черный матовый с керамической крышкой		PIL01NM(X)*	0,40	● Gloss White ● *X = N - Gloss Black ● Le Terre di Cielo	120,00 159,00 169,00		
 <b>Universal click/clack drain in CEMENTO finish with ceramic lid</b> Válvula universal click/clack Cemento con tapa en cerámica Bonde universelle clic/clac Cemento avec clapet en céramique Universal-Abflussgarnitur Click-Clack Cement mit Keramikstopfen Универсальный донный Cemento click/clack с керамической крышкой		PIL01CM(X)*	0,40	● Gloss White ● *X = N - Gloss Black ● Le Terre di Cielo	120,00 159,00 169,00		
 <b>Universal click/clack drain in BRONZE with ceramic lid</b> Válvula universal click/clack Bronce con tapa en cerámica Bonde universelle clic/clac Bronze avec clapet en céramique Universal-Abflussgarnitur Click-Clack Bronze mit Keramikstopfen Универсальный донный клапан click/clack бронза с керамической крышкой		PIL01BR(X)*	0,40	● Gloss White ● *X = N - Gloss Black ● Le Terre di Cielo	135,00 171,00 182,00		

### Technical symbols legend

Símbolos técnicos clave / Légende symboles techniques / Technische Zeichenerklärung / Перечень технических символов

**one tap hole**  
 con 1 agujero  
 monotrou  
 1-Loch  
 одно отверстие под смеситель

**with overflow**  
 con rebosadero  
 avec trop-plein  
 mit Überlauf  
 с переливом

**wall-hung installation**  
 instalación suspendida  
 installation suspendue  
 wandhängende Montage  
 подвесная установка









**with fixing parts**  
 fijaciones incluidas  
 fixations incluses  
 inklusive Befestigungen  
 в комплекте с крепежами

**Combifix compatibility**  
 compatible Combifix  
 mit Combifix kompatibel  
 совместим с combifix

\* Terre di Cielo finishes available for wc-bidet / Acabados Terre di Cielo disponibles para wc-bidet / Finitions Terre di Cielo disponibles pour cuvette-bidet / Für das WC/ Bidet erhältliche Ausführungen Terre di Cielo / Отделка Terre di Cielo доступны для унитаза и биде

● TL - Talco ● PM - Pomice ● BR - Brina ● AN - Arenaria ● AV - Avena ● CM - Cemento ● BA - Basalto



		<b>Size (cm)</b> Medidas Dimensions Maße Размеры	<b>Product code</b> Artículo Article Artikel Артикул	<b>Net weight (Kg)</b> Peso neto Poids net Reingewicht вес нетто	<b>Finishes</b> Acabados Finitions Farbe Отделка	<b>Euro</b> Евро	<b>Pz.</b> шт. pallet Italia	<b>Pz.</b> шт. pallet Cont.
 <p><b>Wc with horizontal outlet convertible to floor outlet by technical curve (4,5 LT)</b>                      Wc con desagüe a pared convertible a suelo con curva técnica (4,5 LT)                      Wc avec évacuation murale transformable à terre avec courbe technique (4,5L)                      WC mit Wandabfluss, durch Kurventechnik auf Bodenabfluss umrüstbar (4,5 LT)                      Слив в стену при помощи технического колена трансформируется на слив в пол (4,5 л)</p>		36 x 55 x 43 h	SHVA(X)*	26,50	● Gloss White ● *X = N - Gloss Black ● *X = TL - Talco ● Le Terre di Cielo*	363,00 561,00 606,00 670,00	15	20
 <p><b>Thermosetting seat &amp; cover</b>                      Asiento para inodoro                      Abattant thermodurcissable                      Wc-sitz thermodur                      Сиденье из термоотверждающейся смолы</p>			CPVSHT	2,40	● Gloss White	102,00		
 <p><b>Thermosetting soft close seat &amp; cover</b>                      Asiento para inodoro amortiguado                      Abattant thermodurcissable soft                      Wc-sitz thermodur mit Abs.                      Сиденье из термоотверждающейся смолы, с плавным опусканием</p>			CPVSHTF(X)*	2,40	● Gloss White ● *X = N - Gloss Black ● *X = TL - Talco ● Le Terre di Cielo*	164,00 253,00 296,00 316,00		
 <p><b>Magic box for wc/bidet</b>                      Magic Box para inodoro/bidet                      Magic box pour cuvette/bidet                      Magic box für Wc/Bidet                      Magic Box для унитаза/биде</p>		41,5 x 12 x 80 h	MABX(X)*	17,50	● Gloss White	250,00	18	36
 <p><b>Technical curve "floor trap" for toilet</b>                      Curva técnica "salida vertical" para inodoro / Courbe technique à S pour cuvette avec sortie au sol / WC-Ablaufbogen "S" / олено "S"-образное для унитазов, регулируемое</p>			CSB	0,40		18,00		
 <p><b>Straight pan connector for wall trap</b>                      Anclaje a pared para inodoro / Pipe pour sortie horizontale / WC-Anschlusstützen für Abgang waagerecht / Фитинг для выпуска в стену для унитазов</p>			RPB	0,35		15,00		

### Technical symbols legend

Símbolos técnicos clave | Légende symboles techniques | Technische Zeichenerklärung | Перечень технических символов

 <p><b>back to wall installation</b>                      instalación a suelo                      installation à terre                      bodenstehende Montage                      напольная установка</p>	 <p><b>with fixing parts</b>                      fijaciones incluidas                      fixations incluses                      inklusive Befestigungen                      в комплекте с крепежами</p>	 <p><b>4,5 l toilet tank</b>                      descarga 4,5 lt                      évacuation à 4,5 l                      4,5 l-Spülung                      бачок на 4,5 л</p>	 <p><b>bifunctional drain</b>                      descarga bifuncional                      évacuation bifonctionnelle                      Spülung mit zwei                      Montagevarianten                      функциональный бачок</p>
---	---	---	--

\* Terre di Cielo finishes available for wc-bidet | Acabados Terre di Cielo disponibles para wc-bidet | Finitions Terre di Cielo disponibles pour cuvette-bidet | Für das WC/Bidet erhältliche Ausführungen Terre di Cielo | отделка Terre di Cielo доступны для унитаза и биде

● TL - Talco ● PM - Pomice ● BR - Brina ● AN - Arenaria ● AV - Avena ● CM - Cemento ● BA - Basalto



## Back to wall one hole bidet

Bidé a suelo monoagujero  
Bidet monotrou  
Stand-Bidet einloch  
Биде напольное с одним отверстием под смеситель

Size (cm) Medidas Dimensions Maße Размеры	Product code Artículo Article Artikel Артикул	Net weight(Kg) Peso neto Poïds net Reingewicht вес нетто	Finishes Acabados Finitions Farbe Отделки	Euro Евро	Pz. шт. pallet Italia	Pz. шт. pallet Cont.
36 x 55 x 43 h	SHBI(X)*	22,80	<ul style="list-style-type: none"> <li><span style="display: inline-block; width: 10px; height: 10px; border: 1px solid black; border-radius: 50%; background-color: white; margin-right: 5px;"></span> Gloss White</li> <li><span style="display: inline-block; width: 10px; height: 10px; border: 1px solid black; border-radius: 50%; background-color: black; margin-right: 5px;"></span> *X = N - Gloss Black</li> <li><span style="display: inline-block; width: 10px; height: 10px; border: 1px solid black; border-radius: 50%; background-color: lightgrey; margin-right: 5px;"></span> *X = TL - Talco</li> <li><span style="display: inline-block; width: 10px; height: 10px; border: 1px solid black; border-radius: 50%; background-color: brown; margin-right: 5px;"></span> Le Terre di Cielo*</li> </ul>	363,00 561,00 606,00 670,00	15	20
41,5 x 12 x 80 h	MABX(X)*	17,50	<ul style="list-style-type: none"> <li><span style="display: inline-block; width: 10px; height: 10px; border: 1px solid black; border-radius: 50%; background-color: white; margin-right: 5px;"></span> Gloss White</li> </ul>	250,00	18	36



## Magic box for wc/bidet

Magic Box para inodoro/bidet  
Magic box pour cuvette/bidet  
Magic box für Wc/Bidet  
Magic Box для унитаза/биде

## Universal click/clack drain in CHROME with ceramic lid

Válvula universal click/clack Cromado con tapa en cerámica  
Bonde universelle clic/clac Chromé avec clapet en céramique  
Universal-Abflussgarnitur Click-Clack Chrom mit Keramikstopfen  
Универсальный донный клапан click/clack хром с керамической крышкой



PIL01(X)\*

0,40

- \*X = N - Gloss Black
- Gloss White
- Le Terre di Cielo

95,00

114,00

139,00

## Universal click/clack drain in BLACK MATT finish with ceramic lid

Válvula universal click/clack Negro Matt con tapa en cerámica  
Bonde universelle clic/clac Noir Mat avec clapet en céramique  
Universal-Abflussgarnitur Click-Clack Matt Schwarz mit Keramikstopfen  
Универсальный донный клапан click/clack черный матовый с керамической крышкой



PIL01NM(X)\*

0,40

- \*X = N - Gloss Black
- Gloss White
- Le Terre di Cielo

120,00

159,00

169,00

## Universal click/clack drain in CEMENTO finish with ceramic lid

Válvula universal click/clack Cemento con tapa en cerámica  
Bonde universelle clic/clac Cemento avec clapet en céramique  
Universal-Abflussgarnitur Click-Clack Cement mit Keramikstopfen  
Универсальный донный Cemento click/clack с керамической крышкой



PIL01CM(X)\*

0,40

- \*X = N - Gloss Black
- Gloss White
- Le Terre di Cielo

120,00

159,00

169,00

## Universal click/clack drain in BRONZE with ceramic lid

Válvula universal click/clack Bronce con tapa en cerámica  
Bonde universelle clic/clac Bronze avec clapet en céramique  
Universal-Abflussgarnitur Click-Clack Bronze mit Keramikstopfen  
Универсальный донный клапан click/clack бронза с керамической крышкой



PIL01BR(X)\*

0,40

- \*X = N - Gloss Black
- Gloss White
- Le Terre di Cielo

135,00

171,00

182,00

## Technical symbols legend

Símbolos técnicos clave | Légende symboles techniques | Technische Zeichenerklärung | Перечень технических символов

<p><b>one tap hole</b> con 1 agujero monotrou 1-Loch одно отверстие под смеситель</p>	<p><b>with overflow</b> con rebosadero avec trop-plein mit Überlauf с переливом</p>	<p><b>back to wall installation</b> instalación a suelo installation à terre bodenstehende Montage напольная установка</p>	<p><b>with fixing parts</b> fijaciones incluidas fixations incluses inklusive Befestigungen в комплекте с крепежами</p>
---	---	--	---

\* Terre di Cielo finishes available for wc-bidet | Acabados Terre di Cielo disponibles para wc-bidet | Finitions Terre di Cielo disponibles pour cuvette-bidet | Für das WC/Bidet erhältliche Ausführungen Terre di Cielo | omđenku Terre di Cielo доступны для унитаза и биде

TL - Talco PM - Pomice BR - Brina AN - Arenaria AV - Avena CM - Cemento BA - Basalto



## Wc with horizontal outlet convertible to floor outlet by technical curve (4,5 LT)

Wc con desagüe a pared convertible a suelo con curva técnica (4,5 LT) / Wc avec évacuation murale transformable à terre avec courbe technique (4,5L) / WC mit Wandabfluss, durch Kurventechnik auf Bodenabfluss umrüstbar (4,5 LT) / Слив в стену при помощи технического колена трансформируется на слив в пол (4,5 л)



## Cistern for monoblock wc

Tanque bajo para inodoro / Reservoir mbl Spülkasten / Бачок для моноблочного унитаза



## Thermosetting seat & cover

Asiento para inodoro Abattant thermodurcissable Wc-sitz thermodur Сиденье из термоотверждающейся смолы



## Thermosetting soft close seat & cover

Asiento para inodoro amortiguado Abattant thermodurcissable soft Wc-sitz thermodur mit Abs. Сиденье из термоотверждающейся смолы, с плавным опусканием



## Double flush discharge mechanism for SHCM cistern

bajo-inodoro SHCM Mécanisme de décharge Spülmechanismus Механизм двойного смыва



## Technical curve "floor trap" for toilet

Curva técnica "salida vertical" para inodoro / Courbe technique à S pour cuvette avec sortie au sol / WC-Ablaufbogen "S" / Колено "S"-образное для унитазов, регулируемое



## Straight pan connector for wall trap

Anclaje a pared para inodoro / Pipe pour sortie horizontale / WC-Anschlussstutzen für Abgang waagerecht / Фитинг для выпуска в стену для унитазов



## 90° technical curve

Curva de técnica a noventa grado / Pipe d'évacuation à 90° / WC-Ablaufbogen 90 Grad / Колено 90° регулируемое

**Size (cm)**

Medidas  
Dimensions  
Maße  
Размеры

**Product code**

Artículo  
Article  
Artikel  
Артикул

**Net weight(Kg)**

Peso neto  
Poids net  
Reingewicht  
вес нетто

**Finishes**

Acabados  
Finitions  
Farbe  
Отделка

**Euro**

Евро

**Pz.**

шт.  
pallet  
Italia

**Pz.**

шт.  
pallet  
Cont.

36 x 55 x  
43 h

SHVA(X)\*

26,50

- Gloss White
- \*X = N - Gloss Black
- \*X = TL - Talco
- Le Terre di Cielo\*

363,00

561,00

606,00

670,00

15

20

36 x 14 x  
98 h

SHCM(X)\*

21,30

- Gloss White
- \*X = N - Gloss Black
- Le Terre di Cielo\*

297,00

433,00

514,00

10

20

CPVSHT

2,40

- Gloss White

102,00

CPVSHTF(X)\*

2,40

- Gloss White
- \*X = N - Gloss Black
- \*X = TL - Talco
- Le Terre di Cielo\*

164,00

253,00

296,00

316,00

SHMEC

2,10

- Chrome

189,00

CSB

0,40

18,00

RPB

0,35

15,00

CSR90

0,75

19,00

## Technical symbols legend

Simbolos técnicos clave / Légende symboles techniques / Technische Zeichenerklärung / Перечень технических символов

**back to wall installation**  
instalación a suelo  
installation à terre  
bodenstehende Montage  
напольная установка

**with fixing parts**  
fijaciones incluidas  
fixations incluses  
inklusive Befestigungen  
в комплекте с крепежами

**4,5 l toilet tank**  
descarga 4,5 l  
évacuation à 4,5 l  
4,5 l-Spülung  
бачок на 4,5 л

**bifunctional drain**  
descarga bifuncional  
évacuation bifonctionnelle  
Spülung mit zwei  
Montagevarianten  
функциональный бачок

**quick release hinge**  
sistema extraíble  
charnières à ouverture  
Takeoff Funktion  
быстрый съем

\* Terre di Cielo finishes available for wc-bidet /  
Acabados Terre di Cielo disponibles para wc-bidet / Finitions  
Terre di Cielo disponibles pour cuvette-bidet / Für das WC/  
Bidet erhältliche Ausführungen Terre di Cielo / Отделка  
Terre di Cielo доступны для унитаза и биде

TL - Talco  PM - Pomice  BR - Brina  AN - Arenaria  AV - Avena  CM - Cemento  BA - Basalto





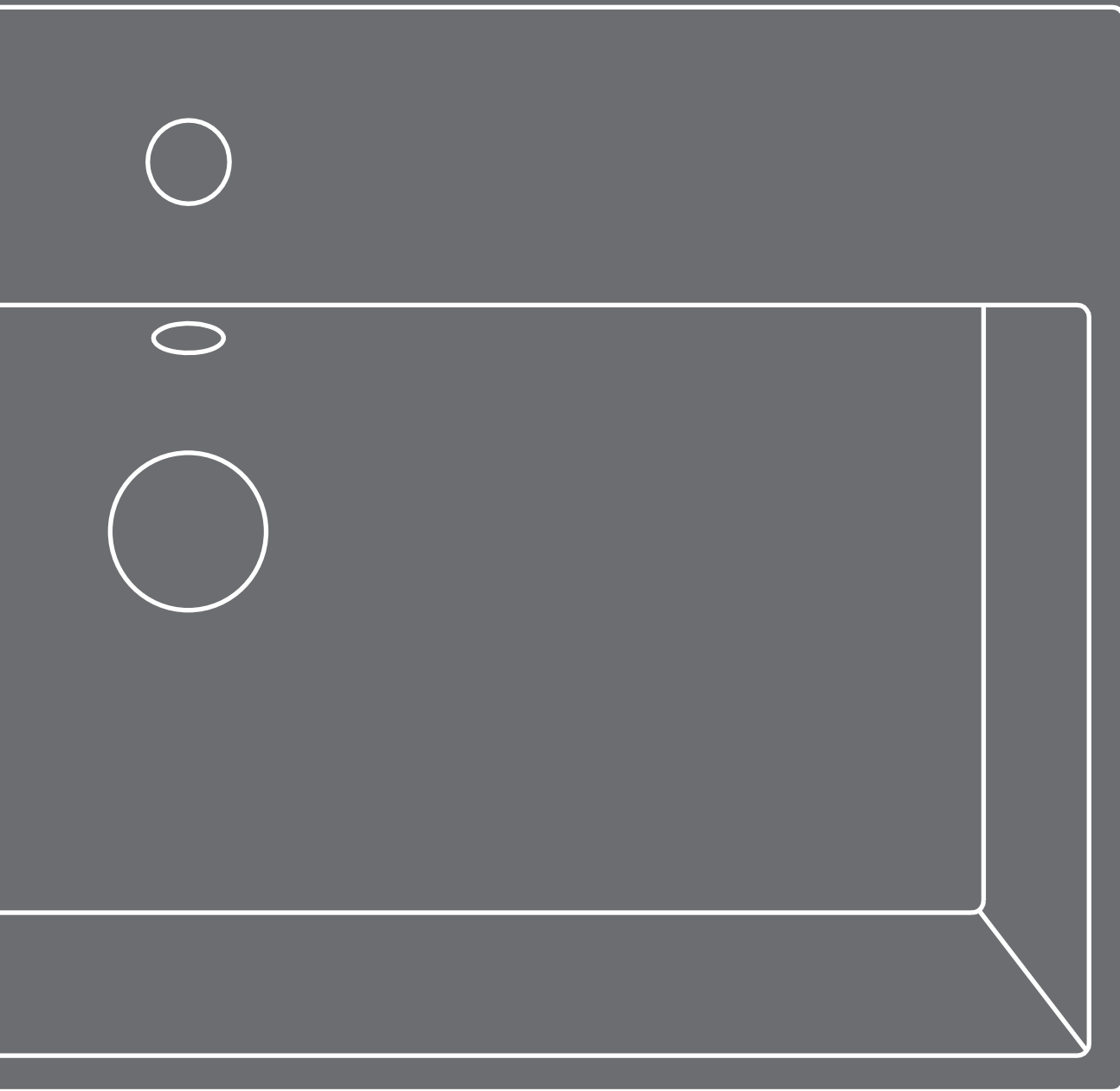

# Smile

indice collezione \ collection index pg. 463

listino prezzi \ price list pg. 464 - 479







## Washbasins finishes (SMLAA50 - SMLAA60 - SMLAA80 - SMLAA100)

Acabados de Lavabos (SMLAA50 - SMLAA60 - SMLAA80 - SMLAA100)  
 Finitions des Lavabos (SMLAA50 - SMLAA60 - SMLAA80 - SMLAA100)  
 Waschbecken Farbe (SMLAA50 - SMLAA60 - SMLAA80 - SMLAA100)  
 Отделки Раковина (SMLAA50 - SMLAA60 - SMLAA80 - SMLAA100)



-  Gloss White
-  N - Gloss Black

### Le Terre di Cielo



-  TL - Talco
-  PM - Pomice
-  BR - Brina
-  CM - Cemento
-  BA - Basalto
-  LV - Lavagna
-  FN - Fango
-  CA - Cacao
-  AN - Arenaria
-  AV - Avena
-  MU - Muschio
-  AG - Agave
-  LN - Lino
-  CN - Canapa
-  CP - Cipria
-  PL - Polvere

## WC and Bidets finishes

Acabados de Sanitarios  
 Finitions des WC et Bidets  
 WC und Bidet Farbe  
 Отделки Унитаз и Биде

-  Gloss White
-  N - Gloss Black (no SMVMR)
-  TL - Talco

### Le Terre di Cielo

-  PM - Pomice
-  BR - Brina
-  AV - Avena
-  AN - Arenaria
-  CM - Cemento
-  BA - Basalto
-  LV - Lavagna  
 [SMVSNW - SMVSNWK - SMBSNW -  
 SMVAS - SMVASK - SMBID - SMVSR  
 - SMVSRK - SMBSR - SMVASTR]

### Le Acque di Cielo

-  OL - Oltremare
-  SM - Smeraldo
-  AL - Alga
-  CO - Corallo
-  NI - Ninfea
-  AM - Anemone

The possible variations of the colour cannot be considered as defect, but as a guarantee of the completely artisan manufacturing of this unique and high quality product.

Las variaciones de colores no se consideran un defecto sino una garantía de una elaboración manual y artesanal en un producto único y de calidad.

Les éventuelles variations de couleur ne peuvent être considérées comme des défauts, elles témoignent en revanche d'une méthode de travail totalement manuelle et artisanale employée pour obtenir un produit fini unique et de qualité.

Eventuelle Farbvariationen sind nicht als Mangel anzusehen, sondern als Garantie für die komplett handwerkliche Anfertigung eines einzigartigen und hochqualitativen Produkts.

Возможные вариации цвета не могут считаться дефектом, а являются подтверждением ручной работы, гарантией качества и уникальности изделия.

## Lavabi / washbasins

installazione sospesa o da piano  
wall-hung or on top installation

**SMLAA100**  
100 x 46 x 13 h  
pag. 464

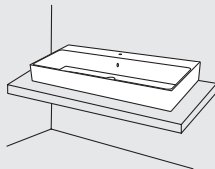
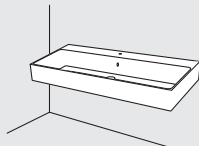

**SMLAA80**  
80 x 46 x 13 h  
pag. 464

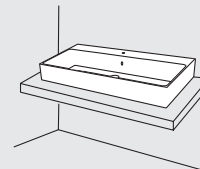
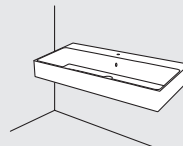

**SMLAA60**  
60 x 46 x 13 h  
pag. 464

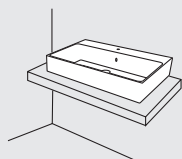
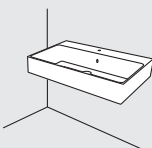

**SMLAA50**  
50 x 46 x 13 h  
pag. 464

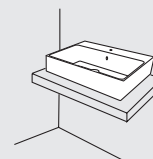
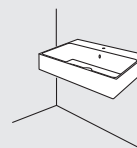

## Wc - bidet

### SMILE 53

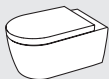

**SMVSNWK**  
senza brida / rimless  
35 x 53 x 27 h  
pag. 466



**SMVSNW**  
35 x 53 x 27 h  
pag. 466

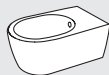

**SMBSNW**  
35 x 53 x 27 h  
pag. 467



**SMVASK**  
senza brida / rimless  
35 x 53 x 42 h  
pag. 468



**SMVAS**  
35 x 53 x 42 h  
pag. 468



**SMBID**  
35 x 53 x 42 h  
pag. 469



**SMVASTR**  
35 x 54 x 42 h  
pag. 470



**SMVAS + SMCM**  
36 x 67 x 92 h  
pag. 472

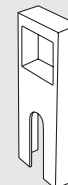

**MABX**  
41,5 x 12 x 80 h  
pag. 468

### SMILE MINI 48

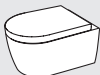

**SMVSRK**  
senza brida / rimless  
35 x 48 x 27 h  
pag. 474



**SMVSR**  
35 x 48 x 27 h  
pag. 474

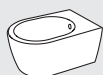

**SMBSR**  
35 x 48 x 27 h  
pag. 475



**SMVASR**  
35 x 48 x 42 h  
pag. 476



**SMVAPR**  
35 x 48 x 42 h  
pag. 476



**SMBIDR**  
35 x 48 x 42 h  
pag. 477



**SMVMR + SMCMC**  
35 x 62 x 84 h  
pag. 478



**SMVMR + SMCMR**  
35 x 62 x 84 h  
pag. 478





## Rectangular washbasin

Lavabo rectangular  
Lavabo rectangulaire  
Waschtisch rechteckig  
Раковина прямоугольная

with 1 hole prepared 3 holes (SMLAA50 - SMLAA60), 5 holes (SMLAA80), 7 holes (SMLAA100)

avec un trou prédisposition à trois trous (SMLAA50 - SMLAA60), à cinq trous (SMLAA80), à sept trous (SMLAA100)  
mit 1-Loch auf 3-Loch durchschlagbar (SMLAA50 - SMLAA60) auf 5-Loch durchschlagbar (SMLAA80), auf 7-Loch durchschlagbar (SMLAA100)  
одно отверстие с возможностью выполнения трех отверстий (SMLAA50 - SMLAA60) выполнения пять отверстий (SMLAA80), выполнения семь отверстий (SMLAA100)

The washbasin is recommended for wall hung installation. For on top installation customers are advised to the require the "RETTIFICA" option.

Se recomienda la instalación del lavabo suspendido. Para instalaciones de apoyo se aconseja usar la opción "RETTIFICA".

La vasque est recommandée pour l'installation suspendu. Pour l'installation à poser on conseille l'option "RETTIFICA".  
Es empfiehlt sich, das Waschbecken hängend zu installieren. Bei Aufsatzmontage bitte die Option "RETTIFICA" anfragen.  
Данная раковина предназначена для подвесной установки. При установке на столешницу рекомендуется запросить опцию "RETTIFICA".

Size (cm)	Product code	Net weight(Kg)	Finishes	Euro	Pz.	Pz.
Medidas Dimensions Maße Размеры	Artículo Article Artikel Артикул	Peso neto Poids net Reingewicht вес нетто	Acabados Finitions Farbe Отделки	Евро	шт. pallet Italia	шт. pallet Cont.
100 x 46 x 13 h	SMLAA100(X)*	26,95	Gloss White *X = N - Gloss Black Le Terre di Cielo	805,00	12	24
	SMLAA100SF(X)* no tap hole sin agujero - sans orifice - ohne Loch без отверстия					
80 x 46 x 13 h	SMLAA80(X)*	23,00	Gloss White *X = N - Gloss Black Le Terre di Cielo	580,00	14	28
	SMLAA80SF(X)* no tap hole sin agujero - sans orifice - ohne Loch без отверстия					
60 x 46 x 13 h	SMLAA60(X)*	17,35	Gloss White *X = N - Gloss Black Le Terre di Cielo	387,00	20	40
	SMLAA60SF(X)* no tap hole sin agujero - sans orifice - ohne Loch без отверстия					
50 x 46 x 13 h	SMLAA50(X)*	14,65	Gloss White *X = N - Gloss Black Le Terre di Cielo	369,00	20	40
	SMLAA50SF(X)* no tap hole sin agujero - sans orifice - ohne Loch без отверстия					
	RETTIFICA GRINDING РЕКТИФИКАЦИЯ			10,00		
	93,5 x 7 h	SMPLAA100	0,55	Chrome	126,00	
	74 x 7 h	SMPLAA80	0,45	Chrome	130,00	
	54 x 7 h	SMPLAA60	0,35	Chrome	124,00	
	44 x 7 h	SMPLAA50	0,30	Chrome	118,00	
	40,5 x 7 h	SMPLAAL	0,35	Chrome	112,00	

## Technical symbols legend

Simbolos técnicos clave / Légende symboles techniques / Technische Zeichenerklärung / Перечень технических символов

























<p><b>one side is unglazed</b> con un lado sin esmaltado avec un côté non émaillé eine Seite unglasiert одна сторона не покрыта эмалью</p>	<p><b>no tap hole on request</b> sin agujero, solo a petición sans orifice sur demande auf Anfrage ohne Loch без отверстия под смеситель по запросу</p>	<p><b>with overflow</b> con rebosadero avec trop-plein mit Überlauf с переливом</p>	<p><b>with 1 hole prepared 3 holes (SMLAA50 - SMLAA60), 5 holes (SMLAA80), 7 holes (SMLAA100)</b> avec un trou prédisposition à trois trous (SMLAA50 - SMLAA60), à cinq trous (SMLAA80), à sept trous (SMLAA100) mit 1-Loch auf 3-Loch durchschlagbar (SMLAA50 - SMLAA60) auf 5-Loch durchschlagbar (SMLAA80), auf 7-Loch durchschlagbar (SMLAA100) одно отверстие с возможностью выполнения трех отверстий (SMLAA50 - SMLAA60) выполнения пять отверстий (SMLAA80), выполнения семь отверстий (SMLAA100)</p>
<p><b>on top installation</b> instalación de apoyo installation à partir du plan Montage auf Platte установка на столешницу</p>	<p><b>wall-hung installation</b> instalación suspendida installation suspendue wandhängende Montage подвесная установка</p>	<p><b>with fixing parts</b> fijaciones incluidas fixations incluses inklusive Befestigungen в комплекте с крепежами</p>	

Le Terre di Cielo	TL - Talco	PM - Pomice	BR - Brina	BA - Basalto	LV - Lavagna	CM - Cemento	FN - Fango	CA - Cacao
	AN - Arenaria	AV - Avena	LN - Lino	AG - Agave	MU - Muschio	PL - Polvere	CP - Cipria	CN - Canapa





























# Smile

drains and siphons | desagües y sifones | les drains et les siphons | Ablaufgarnituren und Siphons | Донные клапаны и сифоны

# cielo

	<b>Product code</b> Artículo Article Artikel Артикул	<b>Net weight</b> (Kg) Peso neto Poids net Reingewicht вес нетто	<b>Finishes</b> Acabados Finitions Farbe Отделки	<b>Euro</b> Euro
 <p><b>Universal click/clack drain in CHROME with ceramic lid</b> Válvula universal click/clack Cromado con tapa en cerámica Bonde universelle clic/clac Chromé avec clapet en céramique Universal-Abflussgarnitur Click-Clack Chrom mit Keramikstopfen Универсальный донный клапан click/clack хром с керамической крышкой</p>	PIL01(X)*	0,40	 <b>Gloss White</b>	<b>95,00</b>
			 <b>*X = N - Gloss Black</b>	<b>114,00</b>
			 <b>Le Terre di Cielo</b>	<b>139,00</b>
 <p><b>Universal click/clack drain in BLACK MATT finish with ceramic lid</b> Válvula universal click/clack Negro Matt con tapa en cerámica Bonde universelle clic/clac Noir Mat avec clapet en céramique Universal-Abflussgarnitur Click-Clack Matt Schwarz mit Keramikstopfen Универсальный донный клапан click/clack черный матовый с керамической крышкой</p>	PIL01NM(X)*	0,40	 <b>Gloss White</b>	<b>120,00</b>
			 <b>*X = N - Gloss Black</b>	<b>159,00</b>
			 <b>Le Terre di Cielo</b>	<b>169,00</b>
 <p><b>Universal click/clack drain in CEMENTO finish with ceramic lid</b> Válvula universal click/clack Cemento con tapa en cerámica Bonde universelle clic/clac Cemento avec clapet en céramique Universal-Abflussgarnitur Click-Clack Cement mit Keramikstopfen Универсальный донный клапан click/clack с керамической крышкой</p>	PIL01CM(X)*	0,40	 <b>Gloss White</b>	<b>120,00</b>
			 <b>*X = N - Gloss Black</b>	<b>159,00</b>
			 <b>Le Terre di Cielo</b>	<b>169,00</b>
 <p><b>Universal click/clack drain in BRONZE with ceramic lid</b> Válvula universal click/clack Bronce con tapa en cerámica Bonde universelle clic/clac Bronze avec clapet en céramique Universal-Abflussgarnitur Click-Clack Bronze mit Keramikstopfen Универсальный донный клапан click/clack бронза с керамической крышкой</p>	PIL01BR(X)*	0,40	 <b>Gloss White</b>	<b>135,00</b>
			 <b>*X = N - Gloss Black</b>	<b>171,00</b>
			 <b>Le Terre di Cielo</b>	<b>182,00</b>
 <p><b>CHROMED siphon</b> Sifone Cromado \ Siphon Chromé \ Siphon Verchromt \ сифон Chrome</p>	SISP	0,93	 <b>Chrome</b>	<b>133,00</b>
 <p><b>MATT BLACK siphon</b> Sifone Negro Mate \ Siphon Noir Mat \ Siphon Schwarz Matt \ Сифон Черный матовый</p>	SIFN	0,93	 <b>Matt Black</b>	<b>194,00</b>
 <p><b>CEMENTO siphon</b> Sifone Cemento \ Siphon Cemento \ Siphon Cemento \ сифон Cemento</p>	SIFCM	0,93	 <b>Cemento</b>	<b>194,00</b>
 <p><b>BRONZE siphon</b> Sifone Bronce \ Siphon Bronze \ Siphon Bronze \ бронза сифон</p>	SIFBR	0,93	 <b>Bronze</b>	<b>220,00</b>



SENZA BRIDA \ RIMLESS		Size (cm)	Product code	Net weight(Kg)	Finishes	Euro	Pz.	Pz.
		Medidas Dimensions Maße Размеры	Artículo Article Artikel Артикул	Peso neto Poids net Reingewicht вес нетто	Acabados Finitions Farbe Отделки	Евро	шт. pallet Italia	шт. pallet Cont.
	<b>Wall-hung wc with hidden fixing system (4,5Lt) - rimless</b> Wc suspendido completo con fijaciones (4,5 LT) - <b>sin brida</b> / Wc suspendu avec fixations (4,5 LT) - <b>sans bride</b> Wand-WC mit Befestigungskit (4,5 lt.) - <b>ohne Spülrand</b> / Подвесной унитаз в комплекте с крепежами (4,5 литр) - без ободка	35 x 53 x 27 h	SMVSNWK(X)*	20,30	<ul style="list-style-type: none"> <li> <b>Gloss White</b></li> <li> <b>*X = N - Gloss Black</b></li> <li> <b>*X = TL - Talco</b></li> <li> <b>Le Terre di Cielo*</b></li> <li> <b>Le Acque di Cielo</b></li> </ul>	428,00 629,00 656,00 728,00 728,00	18	18
	<b>NEW wall-hung wc with hidden fixing system (4,5Lt)</b> Wc suspendido <b>NEW</b> completo con fijaciones (4,5 LT) / Wc suspendu <b>NEW</b> avec fixations cachées (4,5 lt) / Wand-WC <b>NEW</b> mit Einbauhalterungen (4,5 lt) / Унитаз подвесной <b>NEW</b> в комплекте со скрытыми крепежами (4,5 л)	35 x 53 x 27 h	SMVSNW(X)*	21,35	<ul style="list-style-type: none"> <li> <b>Gloss White</b></li> <li> <b>*X = N - Gloss Black</b></li> <li> <b>*X = TL - Talco</b></li> <li> <b>Le Terre di Cielo*</b></li> <li> <b>Le Acque di Cielo</b></li> </ul>	428,00 629,00 656,00 728,00 728,00	18	18
	<b>Thermosetting hard close seat &amp; cover</b> Asiento para inodoro / Abattant thermodurcissable / Wc-sitz thermotur / Сиденье из термоотверждающейся смолы		CPVSM	2,30	<ul style="list-style-type: none"> <li> <b>Gloss White</b></li> </ul>	110,00		
	<b>QUICK RELEASE HINGES</b> <b>Thermosetting contoured wrap lid soft close seat &amp; cover with quick release hinges</b> / Asiento para inodoro amortiguado / Abattant thermodurcissable soft / Wc-sitz thermotur mit Abs. / Сиденье из термоотверждающейся смолы, с плавным опусканием		CPVSMF(X)*	2,30	<ul style="list-style-type: none"> <li> <b>Gloss White</b></li> <li> <b>*X = N - Gloss Black</b></li> <li> <b>*X = TL - Talco</b></li> <li> <b>Le Terre di Cielo*</b></li> <li> <b>Le Acque di Cielo</b></li> </ul>	172,00 253,00 296,00 316,00 316,00		
	<b>QUICK RELEASE HINGES</b> <b>Thermosetting slim double flap soft close seat &amp; cover with quick release hinges</b> / Asiento para inodoro amortiguado bisagra con sistema extraíble / Abattant thermodurcissable soft avec charnières à ouverture / Wc sitz in thermotur mit soft-closet und Takeoff Funktion / Сиденье съемное из термоотверждающейся смолы с плавным опусканием		CPVSMNEWF(X)*	2,30	<ul style="list-style-type: none"> <li> <b>Gloss White</b></li> <li> <b>*X = N - Gloss Black</b></li> <li> <b>*X = TL - Talco</b></li> <li> <b>Le Terre di Cielo*</b></li> <li> <b>Le Acque di Cielo</b></li> </ul>	188,00 253,00 296,00 316,00 316,00		
	<b>Impact and acoustic protection panel</b> Protección antigolpes y acústica / Protection acoustique et anti-choc / Stoss- und Schalldämmung / Противоударная и акустическая защита	3,3 x 18,5 x 55 h	PAA	0,16		17,00		
	<b>Couple of fixing brackets for wall-hung wc/ bidet</b> Pareja de estribo para Inodoro/Bidet suspendido / Étriers de fixation pour Wc/Bidet suspendus / 1 Paar Halterungen für wandhängendes Wc/Bidet / Монтажная рама для подвесного унитаза/биде		508	2,00		39,00		

## Technical symbols legend

Simbolos técnicos clave / Légende symboles techniques / Technische Zeichenerklärung / Перечень технических символов

 **wall-hung installation**  
instalación suspendida  
installation suspendue  
wandhängende Montage  
подвесная установка

 **with fixing parts**  
fijaciones incluidas  
fixations incluses  
inklusive  
Befestigungen  
в комплекте с  
крепежами

 **Combifix compatibility**  
compatible Combifix  
mit Combifix kompatibel  
совместим с combifix

 **rimless**  
sin brida  
sans bride  
ohne Spülrand  
без ободка

 **4,5 l toilet tank**  
descarga 4,5 lt  
évacuation à 4,5 l  
4,5 l-Spülung  
бачок на 4,5 л

 **quick release hinges**  
sistema extraíble  
charnières à ouverture  
Takeoff Funktion  
Быстрый съем

\* **Acque di Cielo finishes available for wc-bidet /**  
Acabados Acque di Cielo disponibles para wc-bidet / Finitions Acque di Cielo disponibles pour cuvette-bidet / Für das WC/Bidet erhältliche Ausführungen Acque di Cielo / отделки Acque di Cielo доступны для унитаза и биде

 **OL - Oltremare**  **SM - Smeraldo**  **AL - Alga**  **CO - Corallo**  **NI - Ninfea**  **AM - Anemone**

\* **Terre di Cielo finishes available for wc-bidet /**  
Acabados Terre di Cielo disponibles para wc-bidet / Finitions Terre di Cielo disponibles pour cuvette-bidet / Für das WC/Bidet erhältliche Ausführungen Terre di Cielo / отделки Terre di Cielo доступны для унитаза и биде

 **TL - Talco**  **PM - Pomice**  **BR - Brina**  **AN - Arenaria**  **AV - Avena**  **CM - Cemento**  **BA - Basalto**  **LV - Lavagna**



## NEW wall-hung one hole bidet with hidden fixing system

Bidé monoagujero suspendido NEW completo con fijaciones  
 Bidet suspendu NEW monotrou avec fixations cachées  
 Wand-Bidet NEW, Einlocharmatur, mit Halterungen  
 Биде подвесное NEW с одним отверстием под смеситель, в комплекте со скрытыми крепежами



Size (cm)	Product code	Net weight(Kg)	Finishes	Euro	Pz.	Pz.
Medidas Dimensions Maße Размеры	Artículo Article Artikel Артикул	Peso neto Poids net Reingewicht вес нетто	Acabados Finitions Farbe Отделка	Евро	шт. pallet Italia	шт. pallet Cont.

35 x 53 x 27 h	SMBSNW(X)*	16,10	<ul style="list-style-type: none"> <li><span style="display: inline-block; width: 10px; height: 10px; background-color: white; border: 1px solid black; border-radius: 50%;"></span> Gloss White</li> <li><span style="display: inline-block; width: 10px; height: 10px; background-color: black; border: 1px solid black; border-radius: 50%;"></span> *X = N - Gloss Black</li> <li><span style="display: inline-block; width: 10px; height: 10px; background-color: white; border: 1px solid black; border-radius: 50%;"></span> *X = TL - Talco</li> <li><span style="display: inline-block; width: 10px; height: 10px; background-color: brown; border: 1px solid black; border-radius: 50%;"></span> Le Terre di Cielo*</li> <li><span style="display: inline-block; width: 10px; height: 10px; background-color: green; border: 1px solid black; border-radius: 50%;"></span> Le Acque di Cielo</li> </ul>	<ul style="list-style-type: none"> <li>428,00</li> <li>629,00</li> <li>656,00</li> <li>728,00</li> <li>728,00</li> </ul>	18	18
----------------	------------	-------	---	--	----	----



## Impact and acoustic protection panel

Protección antigolpes y acústica /  
 Protection acoustique et anti-choc / Stoss-  
 und Schalldämmung / Противоударная и  
 акустическая защита

	PAA	0,16		17,00		
--	-----	------	--	-------	--	--



## Couple of fixing brackets for wall-hung wc/bidet

Pareja de estribo para Inodoro/Bidet suspendido /  
 Étriers de fixation pour Wc/Bidet suspendus /  
 1 Paar Halterungen für wandhängendes Wc/Bidet /  
 Монтажная рама для подвесного унитаза/биде

3,3 x 18,5 x 55 h	508	2,00		39,00		
-------------------	-----	------	--	-------	--	--



## Universal click/clack drain in CHROME with ceramic lid

Válvula universal click/clack Cromado con tapa en cerámica  
 Bonde universelle clic/clac Chromé avec clapet en céramique  
 Universal-Abflussgarnitur Click-Clack Chrom mit Keramikstopfen  
 Универсальный донный клапан click/clack хром с керамической крышкой

PIL01(X)*	0,40	<span style="display: inline-block; width: 10px; height: 10px; background-color: white; border: 1px solid black; border-radius: 50%;"></span> Gloss White	95,00
		<span style="display: inline-block; width: 10px; height: 10px; background-color: black; border: 1px solid black; border-radius: 50%;"></span> *X = N - Gloss Black	114,00
		<span style="display: inline-block; width: 10px; height: 10px; background-color: brown; border: 1px solid black; border-radius: 50%;"></span> Le Terre di Cielo	139,00
		<span style="display: inline-block; width: 10px; height: 10px; background-color: green; border: 1px solid black; border-radius: 50%;"></span> Le Acque di Cielo	139,00



## Universal click/clack drain in BLACK MATT finish with ceramic lid

Válvula universal click/clack Negro Matt con tapa en cerámica  
 Bonde universelle clic/clac Noir Mat avec clapet en céramique  
 Universal-Abflussgarnitur Click-Clack Matt Schwarz mit Keramikstopfen  
 Универсальный донный клапан click/clack черный матовый с керамической крышкой

PIL01NM(X)*	0,40	<span style="display: inline-block; width: 10px; height: 10px; background-color: white; border: 1px solid black; border-radius: 50%;"></span> Gloss White	120,00
		<span style="display: inline-block; width: 10px; height: 10px; background-color: black; border: 1px solid black; border-radius: 50%;"></span> *X = N - Gloss Black	159,00
		<span style="display: inline-block; width: 10px; height: 10px; background-color: brown; border: 1px solid black; border-radius: 50%;"></span> Le Terre di Cielo	169,00
		<span style="display: inline-block; width: 10px; height: 10px; background-color: green; border: 1px solid black; border-radius: 50%;"></span> Le Acque di Cielo	169,00



## Universal click/clack drain in CEMENTO finish with ceramic lid

Válvula universal click/clack Cemento con tapa en cerámica  
 Bonde universelle clic/clac Cemento avec clapet en céramique  
 Universal-Abflussgarnitur Click-Clack Cement mit Keramikstopfen  
 Универсальный донный Cemento click/clack с керамической крышкой

PIL01CM(X)*	0,40	<span style="display: inline-block; width: 10px; height: 10px; background-color: white; border: 1px solid black; border-radius: 50%;"></span> Gloss White	120,00
		<span style="display: inline-block; width: 10px; height: 10px; background-color: black; border: 1px solid black; border-radius: 50%;"></span> *X = N - Gloss Black	159,00
		<span style="display: inline-block; width: 10px; height: 10px; background-color: brown; border: 1px solid black; border-radius: 50%;"></span> Le Terre di Cielo	169,00
		<span style="display: inline-block; width: 10px; height: 10px; background-color: green; border: 1px solid black; border-radius: 50%;"></span> Le Acque di Cielo	169,00



## Universal click/clack drain in BRONZE with ceramic lid

Válvula universal click/clack Bronce con tapa en cerámica  
 Bonde universelle clic/clac Bronze avec clapet en céramique  
 Universal-Abflussgarnitur Click-Clack Bronze mit Keramikstopfen  
 Универсальный донный клапан click/clack бронза с керамической крышкой

PIL01BR(X)*	0,40	<span style="display: inline-block; width: 10px; height: 10px; background-color: white; border: 1px solid black; border-radius: 50%;"></span> Gloss White	135,00
		<span style="display: inline-block; width: 10px; height: 10px; background-color: black; border: 1px solid black; border-radius: 50%;"></span> *X = N - Gloss Black	171,00
		<span style="display: inline-block; width: 10px; height: 10px; background-color: brown; border: 1px solid black; border-radius: 50%;"></span> Le Terre di Cielo	182,00
		<span style="display: inline-block; width: 10px; height: 10px; background-color: green; border: 1px solid black; border-radius: 50%;"></span> Le Acque di Cielo	182,00

### Technical symbols legend

Simbolos técnicos clave / Légende symboles techniques / Technische Zeichenerklärung / Перечень технических символов

one tap hole con 1 agujero monotrou 1-Loch одно отверстие под смеситель	with overflow con rebosadero avec trop-plein mit Überlauf с переливом	wall-hung installation instalación suspendida installation suspendue wandhängende Montage подвесная установка	with fixing parts fijaciones incluidas installations incluses inklusive Befestigungen в комплекте с крепежами	Combifix compatibility compatible Combifix mit Combifix kompatibel совместим с combifix
--	---	---	---	--

### \* Acque di Cielo finishes available for wc-bidet /

Acabados Acque di Cielo disponibles para wc-bidet / Finitions Acque di Cielo disponibles pour cuvette-bidet / Für das WC/Bidet erhältliche Ausführungen Acque di Cielo / отделка Acque di Cielo доступны для унитаза и биде

OL - Oltremare  SM - Smeraldo  AL - Alga  CO - Corallo  NI - Ninfea  AM - Anemone

### \* Terre di Cielo finishes available for wc-bidet /

Acabados Terre di Cielo disponibles para wc-bidet / Finitions Terre di Cielo disponibles pour cuvette-bidet / Für das WC/Bidet erhältliche Ausführungen Terre di Cielo / отделка Terre di Cielo доступны для унитаза и биде

TL - Talco  PM - Pomice  BR - Brina  AN - Arenaria  AV - Avena  CM - Cemento  BA - Basalto  LV - Lavagna

## SENZA BRIDA \ RIMLESS



### Wc with horizontal outlet convertible to floor outlet by technical curve (4,5 LT)

Wc con desagüe a pared convertible a suelo con curva técnica (4,5 LT) / Wc avec évacuation murale transformable à terre avec courbe technique (4,5L) / WC mit Wandabfluss, durch Kurventechnik auf Bodenabfluss umrüstbar (4,5 LT) / Слив в стену при помощи технического колена трансформируется на слив в пол (4,5 л)

**Size (cm)**  
Medidas  
Dimensions  
Maße  
Размеры

**Product code**  
Artículo  
Article  
Artikel  
Артикул

**Net weight(Kg)**  
Peso neto  
Poids net  
Reingewicht  
вес нетто

**Finishes**  
Acabados  
Finitions  
Farbe  
Отделки

**Euro**  
Евро

**Pz.**  
шт.  
pallet  
Italia

**Pz.**  
шт.  
pallet  
Cont.

35 x 53 x 42 h

SMVASK(X)\*

28,90

- Gloss White**
- \*X = N - Gloss Black**
- \*X = TL - Talco**
- Le Terre di Cielo\***
- Le Acque di Cielo**

**407,00**  
**611,00**  
**656,00**  
**740,00**  
**740,00**

15

20



### Wc with horizontal outlet convertible to floor outlet by technical curve (4,5 LT)

Wc con desagüe a pared convertible a suelo con curva técnica (4,5 LT) / Wc avec évacuation murale transformable à terre avec courbe technique (4,5L) / WC mit Wandabfluss, durch Kurventechnik auf Bodenabfluss umrüstbar (4,5 LT) / Слив в стену при помощи технического колена трансформируется на слив в пол (4,5 л)

34 x 53 x 42 h

SMVAS(X)\*

28,90

- Gloss White**
- \*X = N - Gloss Black**
- \*X = TL - Talco**
- Le Terre di Cielo\***
- Le Acque di Cielo**

**407,00**  
**587,00**  
**632,00**  
**714,00**  
**714,00**

15

20



### Thermosetting hard close seat & cover / Asiento para inodoro / Abattant thermodurcissable / Wc-sitz thermodur / Сиденье из термоотверждающейся смолы

CPVSM

2,30

- Gloss White**

**110,00**

### QUICK RELEASE HINGES



### Thermosetting contoured wrap lid soft close seat & cover with quick release hinges

Asiento para inodoro amortiguado / Abattant thermodurcissable soft / Wc-sitz thermodur mit Abs./ Сиденье из термоотверждающейся смолы, с плавным опусканием

CPVSMF(X)\*

2,30

- Gloss White**
- \*X = N - Gloss Black**
- \*X = TL - Talco**
- Le Terre di Cielo\***
- Le Acque di Cielo**

**172,00**  
**253,00**  
**296,00**  
**316,00**  
**316,00**

### QUICK RELEASE HINGES



### Thermosetting slim double flap soft close seat & cover with quick release hinges

Asiento para inodoro amortiguado bisagra con sistema extraíble / Abattant thermodurcissable soft avec charnières à ouverture / Wc sitz in thermodur mit soft-closet und Takeoff Funktion / Сиденье съемное из термоотверждающейся смолы с плавным опусканием

CPVSMNEWF(X)\*

2,30

- Gloss White**
- \*X = N - Gloss Black**
- \*X = TL - Talco**
- Le Terre di Cielo\***
- Le Acque di Cielo**

**188,00**  
**253,00**  
**296,00**  
**316,00**  
**316,00**



### Magic box for wc/bidet

Magic Box para inodoro/bidet / Magic box pour cuvette/bidet / Magic box für Wc/Bidet / Magic Box для унитаза/биде

42 x 12 x 80 h

MABX(X)\*

17,50

- Gloss White**

**250,00**

18

36



### Technical curve "floor trap" for toilet Curva técnica "salida vertical" para inodoro / Courbe technique à S pour cuvette avec sortie au sol / WC-Ablaufbogen "S" / олено "S"-образное для унитазов, регулируемое

CSB

0,40

**18,00**



### Straight pan connector for wall trap

Anclaje a pared para inodoro / Pipe pour sortie horizontale / WC-Anschlussstutzen für Abgang waagerecht / Фитинг для выпуска в стену для унитазов

RPB

0,35

**15,00**

### Technical symbols legend

Simbolos técnicos clave / Légende symboles techniques / Technische Zeichenerklärung / Перечень технических символов



**bifunctional drain**  
descarga bifuncional  
évacuation bifonctionnelle  
Spülung mit zwei  
Montagevarianten  
функциональный бачок



**back to wall installation**  
instalación a suelo  
installation à terre  
bodenstehende Montage  
напольная установка



**with fixing parts**  
fijaciones incluidas  
fixations incluses  
inklusive Befestigungen  
в комплекте с крепежами



**4,5 l toilet tank**  
descarga 4,5 l  
évacuation à 4,5 l  
4,5 l-Spülung  
бачок на 4,5 л



**quick release hinges**  
sistema extraíble  
charnières à ouverture  
Takeoff Funktion  
быстрый съем































**rimless**  
sin brida  
sans bride  
ohne Spülrand  
без ободка

\* Acque di Cielo finishes available for wc-bidet / Acabados Acque di Cielo disponibles para wc-bidet / Finitions Acque di Cielo disponibles pour cuvette-bidet / Für das WC/Bidet erhältliche Ausführungen Acque di Cielo / Отделки Acque di Cielo доступны для унитаза и биде

**OL - Oltremare** **SM - Smeraldo** **AL - Alga** **CO - Corallo** **NI - Ninfea** **AM - Anemone**





\* Terre di Cielo finishes available for wc-bidet / Acabados Terre di Cielo disponibles para wc-bidet / Finitions Terre di Cielo disponibles pour cuvette-bidet / Für das WC/Bidet erhältliche Ausführungen Terre di Cielo / Отделки Terre di Cielo доступны для унитаза и биде

**TL - Talco** **PM - Pomice** **BR - Brina** **AN - Arenaria** **AV - Avena** **CM - Cemento** **BA - Basalto** **LV - Lavagna**

	Size (cm)	Product code	Net weight(Kg)	Finishes	Euro	Pz.	Pz.
	Medidas Dimensions Maße Размеры	Artículo Article Artikel Артикул	Peso neto Poïds net Reingewicht вес нетто	Acabados Finitions Farbe Отделка	Евро	шт. pallet Italia	шт. pallet Cont.
 <p><b>Back to wall one-hole bidet</b> Bidet monoagujero a suelo Bidet monotrou Stand-Bidet einloch Биде напольное с одним отверстием под смеситель</p>	35 x 53 x 42 h	SMBID(X)*	23,15	<ul style="list-style-type: none"> <li> <b>Gloss White</b> 407,00</li> <li> <b>*X = N - Gloss Black</b> 587,00</li> <li> <b>*X = TL - Talco</b> 632,00</li> <li> <b>Le Terre di Cielo*</b> 714,00</li> <li> <b>Le Acque di Cielo</b> 714,00</li> </ul>	407,00	15	20
 <p><b>Magic box for wc/bidet</b> Magic Box para inodoro/bidet / Magic box pour cuvette/bidet / Magic box für Wc/Bidet / agic Вох для унитаза/ биде</p>	42 x 12 x 80 h	MABX(X)*	17,50	<ul style="list-style-type: none"> <li> <b>Gloss White</b> 250,00</li> </ul>	250,00	18	36
 <p><b>Universal click/clack drain in CHROME with ceramic lid</b> Válvula universal click/clack Cromado con tapa en cerámica Bonde universelle clic/clac Chromé avec clapet en céramique Universal-Abflussgarnitur Click-Clack Chrom mit Keramikstopfen Универсальный донный клапан click/clack хром с керамической крышкой</p>		PIL01(X)*	0,40	<ul style="list-style-type: none"> <li> <b>Gloss White</b> 95,00</li> <li> <b>*X = N - Gloss Black</b> 114,00</li> <li> <b>Le Terre di Cielo</b> 139,00</li> <li> <b>Le Acque di Cielo</b> 139,00</li> </ul>			
 <p><b>Universal click/clack drain in BLACK MATT finish with ceramic lid</b> Válvula universal click/clack Negro Matt con tapa en cerámica Bonde universelle clic/clac Noir Mat avec clapet en céramique Universal-Abflussgarnitur Click-Clack Matt Schwarz mit Keramikstopfen Универсальный донный клапан click/clack черный матовый с керамической крышкой</p>		PIL01NM(X)*	0,40	<ul style="list-style-type: none"> <li> <b>Gloss White</b> 120,00</li> <li> <b>*X = N - Gloss Black</b> 159,00</li> <li> <b>Le Terre di Cielo</b> 169,00</li> <li> <b>Le Acque di Cielo</b> 169,00</li> </ul>			
 <p><b>Universal click/clack drain in CEMENTO finish with ceramic lid</b> Válvula universal click/clack Cemento con tapa en cerámica Bonde universelle clic/clac Cemento avec clapet en céramique Universal-Abflussgarnitur Click-Clack Cement mit Keramikstopfen Универсальный донный Cemento click/clack с керамической крышкой</p>		PIL01CM(X)*	0,40	<ul style="list-style-type: none"> <li> <b>Gloss White</b> 120,00</li> <li> <b>*X = N - Gloss Black</b> 159,00</li> <li> <b>Le Terre di Cielo</b> 169,00</li> <li> <b>Le Acque di Cielo</b> 169,00</li> </ul>			
 <p><b>Universal click/clack drain in BRONZE with ceramic lid</b> Válvula universal click/clack Bronze con tapa en cerámica Bonde universelle clic/clac Bronze avec clapet en céramique Universal-Abflussgarnitur Click-Clack Bronze mit Keramikstopfen Универсальный донный клапан click/clack бронза с керамической крышкой</p>		PIL01BR(X)*	0,40	<ul style="list-style-type: none"> <li> <b>Gloss White</b> 135,00</li> <li> <b>*X = N - Gloss Black</b> 171,00</li> <li> <b>Le Terre di Cielo</b> 182,00</li> <li> <b>Le Acque di Cielo</b> 182,00</li> </ul>			

### Technical symbols legend

Simbolos técnicos clave / Légende symboles techniques / Technische Zeichenerklärung / Перечень технических символов

 <p><b>one tap hole</b> con 1 agujero monotrou 1-Loch одно отверстие под смеситель</p>	 <p><b>with overflow</b> con rebosadero avec trop-plein mit Überlauf с переливом</p>	 <p><b>back to wall installation</b> instalación a suelo installation à terre bodenstehende Montage напольная установка</p>	 <p><b>with fixing parts</b> fijaciones incluidas fixations incluses inklusive Befestigungen в комплекте с крепежами</p>
--	---	--	---

### \* Acque di Cielo finishes available for wc-bidet /

Acabados Acque di Cielo disponibles para wc-bidet / Finitions Acque di Cielo disponibles pour cuvette-bidet / Für das WC/Bidet erhältliche Ausführungen Acque di Cielo / отделка Acque di Cielo доступны для унитаза и биде

 OL - Oltremare 
  SM - Smeraldo 
  AL - Alga 
  CO - Corallo 
  NI - Ninfea 
  AM - Anemone













### \* Terre di Cielo finishes available for wc-bidet /

Acabados Terre di Cielo disponibles para wc-bidet / Finitions Terre di Cielo disponibles pour cuvette-bidet / Für das WC/Bidet erhältliche Ausführungen Terre di Cielo / отделка Terre di Cielo доступны для унитаза и биде

 TL - Talco 
  PM - Pomice 
  BR - Brina 
  AN - Arenaria 
  AV - Avena 
  CM - Cemento 
  BA - Basalto 
  LV - Lavagna

# Smile 53 - adjustable water inlet/outlet

# cielo

						Size (cm)	Product code	Net weight(Kg)	Finishes	Euro	Pz.	Pz.
						Medidas Dimensions Maße Размеры	Artículo Article Artikel Артикул	Peso neto Poids net Reingewicht вес нетто	Acabados Finitions Farbe Отделки	Евро	шт. pallet Italia	шт. pallet Cont.
<b>Back-to-wall WC with adjustable water inlet/outlet (4,5 LT)</b> Inodoro a suelo bifuncional con salida a distancia especial (4,5 LT) Vase au sol bifonctionnel avec raccord de la décharge allongé (4,5 LT) Bodenstehendes WC (bifunktional mit einstellbaren Ablauf) (4,5 Lt) Бифункциональный напольный унитаз с адаптируемым выпуском						35 x 54 x 42 h	SMVASTR(X)*	28,85	● Gloss White ● *X = N - Gloss Black ● *X = TL - Talco ● Le Terre di Cielo* ● Le Acque di Cielo	407,00 587,00 632,00 714,00 714,00	15	20
 <b>Thermosetting hard close seat &amp; cover</b> Asiento para inodoro / Abattant thermdurcissable Wc-sitz thermodur / Сиденье из термоотверждающейся смолы							CPVSM	2,30	● Gloss White	110,00		
 <b>QUICK RELEASE HINGES</b>  <b>Thermosetting contoured wrap lid soft close seat &amp; cover with quick release hinges</b> Asiento para inodoro amortiguado / Abattant thermdurcissable soft / Wc-sitz thermodur mit Abs. Сиденье из термоотверждающейся смолы, с плавным опусканием							CPVSMF(X)*	2,30	● Gloss White ● *X = N - Gloss Black ● *X = TL - Talco ● Le Terre di Cielo* ● Le Acque di Cielo	172,00 253,00 296,00 316,00 316,00		
 <b>QUICK RELEASE HINGES</b>  <b>Thermosetting slim double flap soft close seat &amp; cover with quick release hinges</b> Asiento para inodoro amortiguado bisagra con sistema extraible / Abattant thermdurcissable soft avec charnières à ouverture / Wc sitz in thermodur mit soft-closet und Takeoff Funktion / Сиденье съемное из термоотверждающейся смолы с плавным опусканием							CPVSMNEWF(X)*	2,30	● Gloss White ● *X = N - Gloss Black ● *X = TL - Talco ● Le Terre di Cielo* ● Le Acque di Cielo	188,00 253,00 296,00 316,00 316,00		
 <b>Magic box for wc/bidet</b> Magic Box para inodoro/bidet Magic box pour cuvette/bidet Magic box für Wc/Bidet Magic Box для унитаза/биде						42 x 12 x 80 h	MABX(X)*	17,50	● Gloss White	250,00	18	36

## Technical symbols legend

Simbolos técnicos clave / Légende symboles techniques / Technische Zeichenerklärung / Перечень технических символов





 <b>bifunctional drain</b> descarga bifuncional évacuation bifonctionnelle Spülung mit zwei Montagevarianten функциональный бачок	 <b>back to wall installation</b> instalación a suelo installation à terre bodenstehende Montage напольная установка	 <b>with fixing parts</b> fijaciones incluidas fixations incluses inklusive Befestigungen в комплекте с крепежами	 <b>4,5 l toilet tank</b> descarga 4,5 lt évacuation à 4,5 l 4,5 l-Spülung бачок на 4,5 л	 <b>quick release hinges</b> sistema extraible charnières à ouverture Takeoff Funktion быстрый съем
--	---	--	--	--

\* Acque di Cielo finishes available for wc-bidet /  
 Acabados Acque di Cielo disponibles para wc-bidet / Finitions Acque di Cielo disponibles pour cuvette-bidet / Für das WC/Bidet erhältliche Ausführungen Acque di Cielo / Отделки Acque di Cielo доступны для унитаза и биде

● OL - Oltremare ● SM - Smeraldo ● AL - Alga ● CO - Corallo ● NI - Ninfea ● AM - Anemone

\* Terre di Cielo finishes available for wc-bidet /  
 Acabados Terre di Cielo disponibles para wc-bidet / Finitions Terre di Cielo disponibles pour cuvette-bidet / Für das WC/Bidet erhältliche Ausführungen Terre di Cielo / Отделки Terre di Cielo доступны для унитаза и биде

● TL - Talco ● PM - Pomice ● BR - Brina ● AN - Arenaria ● AV - Avena ● CM - Cemento ● BA - Basalto ● LV - Lavagna

	Size (cm) Medidas Dimensions Maße Размеры	Product code Artículo Article Artikel Артикул	Net weight (Kg) Peso neto Poids net Reingewicht вес нетто	Finishes Acabados Finitions Farbe Отделки	Euro Евро	Pz. шт. pallet Italia	Pz. шт. pallet Cont.
 <p><b>Technical curve "floor trap" for toilet.</b> Curva técnica "salida vertical" para inodoro. Courbe technique à S pour cuvette avec sortie au sol. WC-Ablaufbogen "S". Колено "S"-образное для унитазов.</p>		CSB	0,40		18,00		
 <p><b>90° technical curve.</b> Curva de técnica a noventa grados. Pipe d'évacuation à 90°. WC-Aublaufbogen 90 Grad. Колено 90° регулируемое .</p>		CSR90	0,75		19,00		
 <p><b>PVC pipe for adjustable water outlet WC.</b> Curva técnica para inodoro con salida a distancia especial. Courbe technique pour vase avec raccord décharge. Technischer Bogen zum WC mit einstellbaren Ablauf. Колено для унитаза со сливом в пол.</p>		CSTR	0,75		41,00		
 <p><b>Straight pan connector for wall trap</b> Anclaje a pared para inodoro Pipe pour sortie horizontale WC-Anschlussstutzen für Abgang waagerecht Фитинг для выпуска в стену для унитазов</p>		RPB	0,35		15,00		
 <p><b>Eccentric pipe for water outlet up to ± 1,5 cm.</b> Tubo buque trasero excéntrico máximo ± 1,5 cm. Pipe de raccordement d'évacuation WC excentré max ± 1,50 cm. WC-Abgangstutzen mit Excenter (max ± 1,5 cm). Патрубок для унитаза эксцентрический макс. ± 1,5 см.</p>		RSE	0,10		15,00		



# Smile 53 - wc with cistern

# cielo



## Wc with horizontal outlet convertible to floor outlet by technical curve (4,5 LT)

Wc con desagüe a pared convertible a suelo con curva técnica (4,5 LT) / Wc avec évacuation murale transformable à terre avec courbe technique (4,5l) / WC mit Wandabfluss, durch Kurventechnik auf Bodenabfluss umrüstbar (4,5 LT) / Слив в стену при помощи технического колена трансформируется на слив в пол (4,5 л)

+

## Cistern for monoblock wc

Tanque bajo para inodoro  
Reservoir mbl  
Spülkasten  
Бачок для моноблочного унитаза



## Thermosetting hard close seat & cover

Asiento para inodoro  
Abattant thermodurcissable  
Wc-sitz thermodur  
Сиденье из термоотверждающейся смолы



**QUICK RELEASE HINGES** 

## Thermosetting contoured wrap lid soft close seat & cover with quick release hinges

















Asiento para inodoro amortiguado / Abattant thermodurcissable soft / Wc-sitz thermodur mit Abs.  
Сиденье из термоотверждающейся смолы, с плавным опусканием







**QUICK RELEASE HINGES** 

## Thermosetting slim double flap soft close seat & cover with quick release hinges

Asiento para inodoro amortiguado bisagra con sistema extraíble / Abattant thermodurcissable soft avec charnières à ouverture / Wc sitz in thermodur mit soft-closet und Takeoff Funktion / Сиденье съемное из термоотверждающейся смолы с плавным опусканием

Size (cm)	Product code	Net weight (Kg)	Finishes	Euro	Pz.	Pz.
Medidas Dimensions Maße Размеры	Artículo Article Artikel Артикул	Peso neto Poids net Reingewicht вес нетто	Acabados Finitions Farbe Отделки	Евро	шт. pallet Italia	шт. pallet Cont.
35 x 53 x 42 h	SMVAS(X)*	28,90	<ul style="list-style-type: none"> <li> Gloss White</li> <li> *X = N - Gloss Black</li> <li> *X = TL - Talco</li> <li> Le Terre di Cielo*</li> </ul>	<ul style="list-style-type: none"> <li>407,00</li> <li>587,00</li> <li>632,00</li> <li>714,00</li> </ul>	15	20
36 x 14 x 92 h	SMCM(X)*	19,50	<ul style="list-style-type: none"> <li> Gloss White</li> <li> *X = N - Gloss Black</li> <li> Le Terre di Cielo*</li> </ul>	<ul style="list-style-type: none"> <li>297,00</li> <li>427,00</li> <li>543,00</li> </ul>	15	20
	CPVSM	2,30	<ul style="list-style-type: none"> <li> Gloss White</li> </ul>	110,00		
	CPVSMF(X)*	2,30	<ul style="list-style-type: none"> <li> Gloss White</li> <li> *X = N - Gloss Black</li> <li> *X = TL - Talco</li> <li> Le Terre di Cielo*</li> </ul>	<ul style="list-style-type: none"> <li>172,00</li> <li>253,00</li> <li>296,00</li> <li>316,00</li> </ul>		
	CPVSMNEWF(X)*	2,30	<ul style="list-style-type: none"> <li> Gloss White</li> <li> *X = N - Gloss Black</li> <li> *X = TL - Talco</li> <li> Le Terre di Cielo*</li> </ul>	<ul style="list-style-type: none"> <li>188,00</li> <li>253,00</li> <li>296,00</li> <li>316,00</li> </ul>		

	Size (cm) Medidas Dimensions Maße Размеры	Product code Artículo Article Artikel Артикул	Net weight(Kg) Peso neto Poids net Reingewicht вес нетто	Finishes Acabados Finitions Farbe Отделки	Euro Евро	Pz. шт. pallet Italia	Pz. шт. pallet Cont.
 <p><b>Double flush discharge mechanism</b> Mécanisme de descharge Spülmechanismus Механизм двойного смыва</p>		SHMECX	2,45	● <b>Chrome</b>	<b>189,00</b>		
 <p><b>Technical curve "floor trap" for toilet</b> Curva técnica "salida vertical" para inodoro / Courbe technique à S pour cuvette avec sortie au sol / WC-Ablaufbogen "S" / Колено "S"-образное для унитазов, регулируемое</p>		CSB	0,40		<b>18,00</b>		
 <p><b>Straight pan connector for wall trap</b> Anclaje a pared para inodoro / Pipe pour sortie horizontale / WC-Anschlussstutzen für Abgang waagrecht / Фитинг для выпуска в стену для унитазов</p>		RPB	0,35		<b>15,00</b>		
 <p><b>90° technical curve</b> Curva de técnica a noventa grado / Pipe d'évacuation à 90° / WC-Ablaufbogen 90 Grad / Колено 90° регулируемое</p>		CSR90	0,75		<b>19,00</b>		

## Technical symbols legend

Simbolos técnicos clave / Légende symboles techniques / Technische Zeichenerklärung / Перечень технических символов

 **bifunctional drain**  
descarga bifuncional  
évacuation bifonctionnelle  
Spülung mit zwei  
Montagevarianten  
функциональный бачок

 **back to wall installation**  
instalación a suelo  
installation à terre  
bodenstehende Montage  
напольная установка







 **with fixing parts**  
fijaciones incluidas  
fixations incluses  
inklusive Befestigungen  
в комплекте с крепежами

 **4,5 l toilet tank**  
descarga 4,5 lt  
évacuation à 4,5 l  
4,5 l-Spülung  
бачок на 4,5 л

 **quick release hinges**  
sistema extraíble  
charnières à ouverture  
Takeoff Funktion  
быстрый съем

\* Terre di Cielo finishes available for wc-bidet / Acabados Terre di Cielo disponibles para wc-bidet / Finitions Terre di Cielo disponibles pour cuvette-bidet / Für das WC/Bidet erhältliche Ausführungen Terre di Cielo / отделка Terre di Cielo доступны для унитаза и биде

● TL - Talco ● PM - Pomice ● BR - Brina ● AN - Arenaria ● AV - Avena ● CM - Cemento ● BA - Basalto

	Size (cm)	Product code	Net weight(Kg)	Finishes	Euro	Pz.	Pz.
	Medidas Dimensions Maße Размеры	Artículo Article Artikel Артикул	Peso neto Poids net Reingewicht вес нетто	Acabados Finitions Farbe Отделки	Евро	шт. pallet Italia	шт. pallet Cont.
<b>SENZA BRIDA \ RIMLESS</b>  <p><b>MINI wall-hung wc with fixing kit (4,5 LT) - rimless</b>                      Wc suspendido MINI completo con fijaciones (4,5 LT) - sin brida / Wc suspendu MINI avec fixations (4,5 LT) - sans bride Wand-WC MINI mit Befestigungskit (4,5 Lt.) - ohne Spülrand / Подвесной унитаз MINI в комплекте с крепежами (4,5 литр) - без ободка</p>	35 x 48 x 27 h	SMVSRK(X)*	19,00	○ Gloss White ○ *X = TL - Talco ● Le Terre di Cielo* ● Le Acque di Cielo	407,00 642,00 662,00 662,00	18	18
 <p><b>MINI wall-hung wc with hidden fixing system (4,5L)</b>                      Wc suspendido MINI completo con fijaciones (4,5 LT)                      Wc suspendu MINI avec fixations cachées (4,5 lt)                      Wand-WC MINI mit Einbauhalterungen (4,5 l)                      Унитаз подвесной MINI в комплекте со скрытыми крепежами (4,5 л)</p>	35 x 48 x 27 h	SMVSR(X)*	20,50	○ Gloss White ● *X = N - Gloss Black ○ *X = TL - Talco ● Le Terre di Cielo* ● Le Acque di Cielo	380,00 525,00 595,00 651,00 651,00	18	18
 <p><b>Thermosetting hard close seat &amp; cover /</b> Asiento para inodoro / Abattant thermoturcissable                      Wc-sitz thermotur / Сиденье из термоотверждающейся смолы</p>		CPVSM	2,30	○ Gloss White	110,00		
 <p><b>QUICK RELEASE HINGES</b>  <b>Thermosetting contoured wrap lid soft close seat &amp; cover with quick release hinges</b>                      Asiento para inodoro amortiguado / Abattant thermoturcissable soft / Wc-sitz thermotur mit Abs./ Сиденье из термоотверждающейся смолы, с плавным опусканием</p>		CPVSMF(X)*	2,30	○ Gloss White ● *X = N - Gloss Black ○ *X = TL - Talco ● Le Terre di Cielo* ● Le Acque di Cielo	172,00 253,00 296,00 316,00 316,00		
 <p><b>QUICK RELEASE HINGES</b>  <b>Thermosetting slim double flap soft close seat &amp; cover with quick release hinges</b>                      Asiento para inodoro amortiguado bisagra con sistema extraible / Abattant thermoturcissable soft avec charnières à ouverture / Wc sitz in thermotur mit soft-closet und Takeoff Funktion / Сиденье съемное из термоотверждающейся смолы с плавным опусканием</p>		CPVSMNEWF(X)*	2,30	○ Gloss White ● *X = N - Gloss Black ○ *X = TL - Talco ● Le Terre di Cielo* ● Le Acque di Cielo	188,00 253,00 296,00 316,00 316,00		
 <p><b>Impact and acoustic protection panel</b>                      Protección antigolpes y acústica / Protection acoustique et anti-choc / Stoss- und Schalldämmung / Противоударная и акустическая защита</p>	3,3 x 18,5 x 55 h	PAA	0,16		17,00		
 <p><b>Couple of fixing brackets for wall-hung wc/ bidet</b>                      Pareja de estribo para Inodoro/Bidet suspendido / Étriers de fixation pour Wc/Bidet suspendus / Paar Halterungen für wandhängendes Wc/Bidet / Монтажная рама для подвесного унитаза/биде</p>		508	2,00		39,00		

### Technical symbols legend

Simbolos técnicos clave / Légende symboles techniques / Technische Zeichenerklärung / Перечень технических символов

 wall-hung installation  
 instalación suspendida  
 installation suspendue  
 wandhängende Montage  
 подвесная установка

 with fixing parts  
 fijaciones incluidas  
 fixations incluses  
 inklusive Befestigungen  
 в комплекте с крепежами

 Combifix compatibility  
 compatible Combifix  
 mit Combifix kompatibel  
 совместим с combifix

 4,5 l toilet tank  
 descarga 4,5 l  
 évacuation à 4,5 l  
 4,5 l-Spülung  
 бачок на 4,5 л

 quick release hinges  
 sistema extraíble  
 charnières à ouverture  
 takeoff Funktion  
 быстрый съем

 rimless  
 sin brida  
 sans bride  
 ohne Spülrand  
 без ободка

\* Acque di Cielo finishes available for wc-bidet /  
 Acabados Acque di Cielo disponibles para wc-bidet / Finitions Acque di Cielo disponibles pour cuvette-bidet / Für das WC/Bidet erhältliche Ausführungen Acque di Cielo / Отделка Acque di Cielo доступны для унитаза и биде







● OL - Oltremare ● SM - Smeraldo ● AL - Alga ● CO - Corallo ● NI - Ninfea ● AM - Anemone

\* Terre di Cielo finishes available for wc-bidet /  
 Acabados Terre di Cielo disponibles para wc-bidet / Finitions Terre di Cielo disponibles pour cuvette-bidet / Für das WC/Bidet erhältliche Ausführungen Terre di Cielo / Отделка Terre di Cielo доступны для унитаза и биде

● TL - Talco ● PM - Pomice ● BR - Brina ● AN - Arenaria ● AV - Avena ● CM - Cemento ● BA - Basalto ● LV - Lavagna

# Smile Mini 48 - bidet

# cielo

	Size (cm)	Product code	Net weight(Kg)	Finishes	Euro	Pz.	Pz.
	Medidas Dimensions Maße Размеры	Artículo Article Artikel Артикул	Peso neto Poids net Reingewicht вес нетто	Acabados Finitions Farbe Отделки	Евро	шт. pallet Italia	шт. pallet Cont.
 <p><b>MINI wall-hung one hole bidet with hidden fixing system / Bidé monoagujero suspendido MINI completo con fijaciones / Bidet suspendu MINI monotrou avec fixations cachées / Wand-Bidet MINI, Einlocharmatur, mit Halterungen / Биде подвесное MINI с одним отверстием под смеситель, в комплекте со скрытыми крепежами</b></p>	35 x 48 x 27 h	SMBSR(X)*	13,70	<ul style="list-style-type: none"> <li><span style="display: inline-block; width: 10px; height: 10px; background-color: white; border: 1px solid black; border-radius: 50%;"></span> Gloss White</li> <li><span style="display: inline-block; width: 10px; height: 10px; background-color: black; border: 1px solid black; border-radius: 50%;"></span> *X = N - Gloss Black</li> <li><span style="display: inline-block; width: 10px; height: 10px; background-color: white; border: 1px solid black; border-radius: 50%;"></span> *X = TL - Talco</li> <li><span style="display: inline-block; width: 10px; height: 10px; background-color: #8B4513; border: 1px solid black; border-radius: 50%;"></span> Le Terre di Cielo*</li> <li><span style="display: inline-block; width: 10px; height: 10px; background-color: #2E8B57; border: 1px solid black; border-radius: 50%;"></span> Le Acque di Cielo</li> </ul>	380,00	18	18
 <p><b>Impact and acoustic protection panel</b> Protección antigolpes y acústica / Protection acoustique et anti-choc / Stoss- und Schalldämmung / Противоударная и акустическая защита</p>		PAA	0,16		17,00		
 <p><b>Couple of fixing brackets for wall-hung wc/bidet - Pareja de estribo para Inodoro/Bidet suspendido / Étriers de fixation pour Wc/Bidet suspendus / 1 Paar Halterungen für wandhängendes Wc/Bidet / Монтажная рама для подвесного унитаза/биде</b></p>	3,3 x 18,5 x 55 h	508	2,00		39,00		
 <p><b>Universal click/clack drain in CHROME with ceramic lid</b> Válvula universal click/clac Cromado con tapa en cerámica Bonde universelle clic/clac Chromé avec clapet en céramique Universal-Abflussgarnitur Click-Clack Chrom mit Keramikstopfen Универсальный донный клапан click/clack хром с керамической крышкой</p>		PIL01(X)*	0,40	<ul style="list-style-type: none"> <li><span style="display: inline-block; width: 10px; height: 10px; background-color: white; border: 1px solid black; border-radius: 50%;"></span> Gloss White</li> <li><span style="display: inline-block; width: 10px; height: 10px; background-color: black; border: 1px solid black; border-radius: 50%;"></span> *X = N - Gloss Black</li> <li><span style="display: inline-block; width: 10px; height: 10px; background-color: #8B4513; border: 1px solid black; border-radius: 50%;"></span> Le Terre di Cielo</li> <li><span style="display: inline-block; width: 10px; height: 10px; background-color: #2E8B57; border: 1px solid black; border-radius: 50%;"></span> Le Acque di Cielo</li> </ul>	95,00		
 <p><b>Universal click/clack drain in BLACK MATT finish with ceramic lid</b> Válvula universal click/clac Negro Matt con tapa en cerámica Bonde universelle clic/clac Noir Mat avec clapet en céramique Universal-Abflussgarnitur Click-Clack Matt Schwarz mit Keramikstopfen Универсальный донный клапан click/clack черный матовый с керамической крышкой</p>		PIL01NM(X)*	0,40	<ul style="list-style-type: none"> <li><span style="display: inline-block; width: 10px; height: 10px; background-color: white; border: 1px solid black; border-radius: 50%;"></span> Gloss White</li> <li><span style="display: inline-block; width: 10px; height: 10px; background-color: black; border: 1px solid black; border-radius: 50%;"></span> *X = N - Gloss Black</li> <li><span style="display: inline-block; width: 10px; height: 10px; background-color: #8B4513; border: 1px solid black; border-radius: 50%;"></span> Le Terre di Cielo</li> <li><span style="display: inline-block; width: 10px; height: 10px; background-color: #2E8B57; border: 1px solid black; border-radius: 50%;"></span> Le Acque di Cielo</li> </ul>	120,00		
 <p><b>Universal click/clack drain in CEMENTO finish with ceramic lid</b> Válvula universal click/clac Cemento con tapa en cerámica Bonde universelle clic/clac Cemento avec clapet en céramique Universal-Abflussgarnitur Click-Clack Cement mit Keramikstopfen Универсальный донный Cemento click/clack с керамической крышкой</p>		PIL01CM(X)*	0,40	<ul style="list-style-type: none"> <li><span style="display: inline-block; width: 10px; height: 10px; background-color: white; border: 1px solid black; border-radius: 50%;"></span> Gloss White</li> <li><span style="display: inline-block; width: 10px; height: 10px; background-color: black; border: 1px solid black; border-radius: 50%;"></span> *X = N - Gloss Black</li> <li><span style="display: inline-block; width: 10px; height: 10px; background-color: #8B4513; border: 1px solid black; border-radius: 50%;"></span> Le Terre di Cielo</li> <li><span style="display: inline-block; width: 10px; height: 10px; background-color: #2E8B57; border: 1px solid black; border-radius: 50%;"></span> Le Acque di Cielo</li> </ul>	120,00		
 <p><b>Universal click/clack drain in BRONZE finish with ceramic lid</b> Válvula universal click/clac Bronce con tapa en cerámica Bonde universelle clic/clac Bronze avec clapet en céramique Universal-Abflussgarnitur Click-Clack Bronze mit Keramikstopfen Универсальный донный клапан click/clack бронза с керамической крышкой</p>		PIL01BR(X)*	0,40	<ul style="list-style-type: none"> <li><span style="display: inline-block; width: 10px; height: 10px; background-color: white; border: 1px solid black; border-radius: 50%;"></span> Gloss White</li> <li><span style="display: inline-block; width: 10px; height: 10px; background-color: black; border: 1px solid black; border-radius: 50%;"></span> *X = N - Gloss Black</li> <li><span style="display: inline-block; width: 10px; height: 10px; background-color: #8B4513; border: 1px solid black; border-radius: 50%;"></span> Le Terre di Cielo</li> <li><span style="display: inline-block; width: 10px; height: 10px; background-color: #2E8B57; border: 1px solid black; border-radius: 50%;"></span> Le Acque di Cielo</li> </ul>	135,00		

## Technical symbols legend

Simbolos técnicos clave | Légende symboles techniques | Technische Zeichenerklärung | Перечень технических символов

 **one tap hole**  
con 1 agujero  
monotrou  
1-Loch  
одно отверстие под смеситель

 **with overflow**  
con rebosadero  
avec trop-plein  
mit Überlauf  
с переливом

 **wall-hung installation**  
instalación suspendida  
installation suspendue  
wandhängende Montage  
подвесная установка

 **Combifix compatibility**  
compatible Combifix  
mit Combifix kompatibel  
совместим с combifix

### \* Acque di Cielo finishes available for wc-bidet /

Acabados Acque di Cielo disponibles para wc-bidet | Finitions Acque di Cielo disponibles pour cuvette-bidet | Für das WC/Bidet erhältliche Ausführungen Acque di Cielo | Отделки Acque di Cielo доступны для унитаза и биде

 OL - Oltremare  SM - Smeraldo  AL - Alga  CO - Corallo  NI - Ninfea  AM - Anemone

### \* Terre di Cielo finishes available for wc-bidet /

Acabados Terre di Cielo disponibles para wc-bidet | Finitions Terre di Cielo disponibles pour cuvette-bidet | Für das WC/Bidet erhältliche Ausführungen Terre di Cielo | Отделки Terre di Cielo доступны для унитаза и биде

 TL - Talco  PM - Pomice  BR - Brina  AN - Arenaria  AV - Avena  CM - Cemento  BA - Basalto  LV - Lavagna



### MINI wc with floor trap (4,5 LT)

Inodoro **MINI** con salida a suelo (4,5 LT)  
Cuvette avec sortie au sol **MINI** (4,5 LT)  
Stand-WC Abgang senkrecht **MINI** (4,5 LT)  
Унитаз со сливом в пол **MINI** (4,5 л)

Size (cm)	Product code	Net weight(Kg)	Finishes	Euro	Pz.	Pz.
Medidas Dimensions Maße Размеры	Artículo Article Artikel Артикул	Peso neto Poids net Reingewicht вес нетто	Acabados Finitions Farbe Отделки	Евро	шт. pallet Italia	шт. pallet Cont.
35 x 48 x 42 h	SMVASR(X)*	25,20	<ul style="list-style-type: none"> <li> <b>Gloss White</b></li> <li> <b>*X = N - Gloss Black</b></li> <li> <b>*X = TL - Talco</b></li> <li> <b>Le Terre di Cielo*</b></li> <li> <b>Le Acque di Cielo</b></li> </ul>	<ul style="list-style-type: none"> <li><b>368,00</b></li> <li><b>479,00</b></li> <li><b>551,00</b></li> <li><b>600,00</b></li> <li><b>600,00</b></li> </ul>	15	20
35 x 48 x 42 h	SMVAPR(X)*	25,20	<ul style="list-style-type: none"> <li> <b>Gloss White</b></li> <li> <b>*X = N - Gloss Black</b></li> <li> <b>*X = TL - Talco</b></li> <li> <b>Le Terre di Cielo*</b></li> <li> <b>Le Acque di Cielo</b></li> </ul>	<ul style="list-style-type: none"> <li><b>368,00</b></li> <li><b>479,00</b></li> <li><b>551,00</b></li> <li><b>600,00</b></li> <li><b>600,00</b></li> </ul>	15	20

### MINI wc with wall trap (4,5 LT)

Inodoro **MINI** con salida a pared (4,5 LT)  
Cuvette avec sortie au mur **MINI** (4,5 LT)  
Stand-WC Abgang waagrecht **MINI** (4,5 LT)  
Унитаз со сливом в стену **MINI** (4,5 л)



**Thermosetting hard close seat & cover** / Asiento para inodoro / Abattant thermodurcissable / Wc-sitz thermodur / Сиденье из термоотверждающейся смолы

CPVSM

2,30

**Gloss White**

**110,00**



**Thermosetting contoured wrap lid soft close seat & cover with quick release hinges**

Asiento para inodoro amortiguado / Abattant thermodurcissable soft / Wc-sitz thermodur mit Abs. / Сиденье из термоотверждающейся смолы, с плавным опусканием

CPVSMF(X)\*

2,30

- Gloss White**
- \*X = N - Gloss Black**
- \*X = TL - Talco**
- Le Terre di Cielo\***
- Le Acque di Cielo**

- 172,00**
- 253,00**
- 296,00**
- 316,00**
- 316,00**



**Thermosetting slim double flap soft close seat & cover with quick release hinges**

Asiento para inodoro amortiguado bisagra con sistema extraible / Abattant thermodurcissable soft avec charnières à ouverture / Wc-sitz in thermodur mit soft-closet und Takeoff Funktion / Сиденье съемное из термоотверждающейся смолы с плавным опусканием

CPVSMNEWF(X)\*

2,30

- Gloss White**
- \*X = N - Gloss Black**
- \*X = TL - Talco**
- Le Terre di Cielo\***
- Le Acque di Cielo**

- 188,00**
- 253,00**
- 296,00**
- 316,00**
- 316,00**



**Magic box for wc/bidet**

Magic Box para inodoro/bidet / Magic box pour cuvette/bidet / Magic box für Wc/Bidet / agic Вох для унитаза/ биде

42 x 12 x  
80 h

MABX(X)\*

17,50

**Gloss White**

**250,00**

18

36

### Technical symbols legend

Simbolos técnicos clave / Légende symboles techniques / Technische Zeichenerklärung / Перечень технических символов

**back to wall installation**  
instalación a suelo  
installation à terre  
bodenstehende Montage  
напольная установка

**with fixing parts**  
fijaciones incluidas  
fixations incluses  
inklusive Befestigungen  
в комплекте с крепежами

**4,5 l toilet tank**  
descarga 4,5 lt  
évacuation à 4,5 l  
4,5 l-Spülung  
бачок на 4,5 л

**quick release hinges**  
sistema extraible  
charnières à ouverture  
Takeoff Funktion  
быстрый сьем

\* **Acque di Cielo finishes available for wc-bidet** / Acabados Acque di Cielo disponibles para wc-bidet / Finitions Acque di Cielo disponibles pour cuvette-bidet / Für das WC/Bidet erhältliche Ausführungen Acque di Cielo / Отделки Acque di Cielo доступны для унитаза и биде

**OL - Oltremare** **SM - Smeraldo** **AL - Alga** **CO - Corallo** **NI - Ninfea** **AM - Anemone**

\* **Terre di Cielo finishes available for wc-bidet** / Acabados Terre di Cielo disponibles para wc-bidet / Finitions Terre di Cielo disponibles pour cuvette-bidet / Für das WC/Bidet erhältliche Ausführungen Terre di Cielo / Отделки Terre di Cielo доступны для унитаза и биде

**TL - Talco** **PM - Pomice** **BR - Brina** **AN - Arenaria** **AV - Avena** **CM - Cemento** **BA - Basalto**

# Smile Mini 48 - bidet

# cielo



## MINI back to wall one-hole bidet

Bidet monoagujero a suelo **MINI**  
 Bidet **MINI** monotrou  
 Stand-Bidet **MINI** einloch  
 Биде напольное **MINI** с одним отверстием под смеситель

Size (cm) Medidas Dimensions Maße Размеры	Product code Artículo Article Artikel Артикул	Net weight(Kg) Peso neto Poids net Reingewicht вес нетто	Finishes Acabados Finitions Farbe Отделки	Euro Евро	Pz. шт. pallet Italia	Pz. шт. pallet Cont.
35 x 48 x 42 h	SMBIDR(X)*	22,50	<ul style="list-style-type: none"> <li> <b>Gloss White</b></li> <li> <b>*X = N - Gloss Black</b></li> <li> <b>*X = TL - Talco</b></li> <li> <b>Le Terre di Cielo*</b></li> <li> <b>Le Acque di Cielo</b></li> </ul>	<b>368,00</b> <b>479,00</b> <b>551,00</b> <b>600,00</b> <b>600,00</b>	15	20



## Magic box for wc/bidet

Magic Box para inodoro/bidet  
 Magic box pour cuvette/bidet  
 Magic box für Wc/Bidet  
 Magic Box для унитаза/биде

42 x 12 x 80 h	MABX(X)*	17,50	<ul style="list-style-type: none"> <li> <b>Gloss White</b></li> </ul>	<b>250,00</b>	18	36
----------------	----------	-------	---	---------------	----	----



### Universal click/clack drain in CHROME with ceramic lid

Válvula universal click/clack Cromado con tapa en cerámica  
 Bonde universelle clic/clac Chromé avec clapet en céramique  
 Universal-Abflussgarnitur Click-Clack Chrom mit Keramikstopfen  
 Универсальный донный клапан click/clack хром с керамической крышкой

PIL01(X)\*

0,40

	<b>Gloss White</b>	<b>95,00</b>
	<b>*X = N - Gloss Black</b>	<b>114,00</b>
	<b>Le Terre di Cielo</b>	<b>139,00</b>
	<b>Le Acque di Cielo</b>	<b>139,00</b>



### Universal click/clack drain in BLACK MATT finish with ceramic lid

Válvula universal click/clack Negro Matt con tapa en cerámica  
 Bonde universelle clic/clac Noir Mat avec clapet en céramique  
 Universal-Abflussgarnitur Click-Clack Matt Schwarz mit Keramikstopfen  
 Универсальный донный клапан click/clack черный матовый с керамической крышкой

PIL01NM(X)\*

0,40

	<b>Gloss White</b>	<b>120,00</b>
	<b>*X = N - Gloss Black</b>	<b>159,00</b>
	<b>Le Terre di Cielo</b>	<b>169,00</b>
	<b>Le Acque di Cielo</b>	<b>169,00</b>



### Universal click/clack drain in CEMENTO finish with ceramic lid

Válvula universal click/clack Cemento con tapa en cerámica  
 Bonde universelle clic/clac Cemento avec clapet en céramique  
 Universal-Abflussgarnitur Click-Clack Cement mit Keramikstopfen  
 Универсальный донный Cemento click/clack с керамической крышкой

PIL01CM(X)\*

0,40

	<b>Gloss White</b>	<b>120,00</b>
	<b>*X = N - Gloss Black</b>	<b>159,00</b>
	<b>Le Terre di Cielo</b>	<b>169,00</b>
	<b>Le Acque di Cielo</b>	<b>169,00</b>



### Universal click/clack drain in BRONZE with ceramic lid

Válvula universal click/clack Bronce con tapa en cerámica  
 Bonde universelle clic/clac Bronze avec clapet en céramique  
 Universal-Abflussgarnitur Click-Clack Bronze mit Keramikstopfen  
 Универсальный донный клапан click/clack бронза с керамической крышкой

PIL01BR(X)\*

0,40

	<b>Gloss White</b>	<b>135,00</b>
	<b>*X = N - Gloss Black</b>	<b>171,00</b>
	<b>Le Terre di Cielo</b>	<b>182,00</b>
	<b>Le Acque di Cielo</b>	<b>182,00</b>

## Technical symbols legend

Simbolos técnicos clave | Légende symboles techniques | Technische Zeichenerklärung | Перечень технических символов

<p><b>one tap hole</b>                  con 1 agujero                  monotrou                  1-Loch                  одно отверстие под смеситель</p>	<p><b>with overflow</b>                  con rebosadero                  avec trop-plein                  mit Überlauf                  с переливом</p>	<p><b>back to wall installation</b>                  instalación a suelo                  installation à terre                  bodenstehende Montage                  напольная установка</p>	<p><b>with fixing parts</b>                  fijaciones incluidas                  fixations incluses                  inklusive Befestigungen                  в комплекте с крепежами</p>
---	---	--	---

### \* Acque di Cielo finishes available for wc-bidet /

Acabados Acque di Cielo disponibles para wc-bidet | Finitions Acque di Cielo disponibles pour cuvette-bidet | Für das WC/Bidet erhältliche Ausführungen Acque di Cielo | Отделки Acque di Cielo доступны для унитаза и биде

**OL - Oltremare** **SM - Smeraldo** **AL - Alga** **CO - Corallo** **NI - Ninfea** **AM - Anemone**

### \* Terre di Cielo finishes available for wc-bidet /

Acabados Terre di Cielo disponibles para wc-bidet | Finitions Terre di Cielo disponibles pour cuvette-bidet | Für das WC/Bidet erhältliche Ausführungen Terre di Cielo | Отделки Terre di Cielo доступны для унитаза и биде

**TL - Talco** **PM - Pomice** **BR - Brina** **AN - Arenaria** **AV - Avena** **CM - Cemento** **BA - Basalto**





## MINI Monoblock wc with horizontal outlet convertible to floor outlet by technical curve (4,5 LT)

Wc monobloque **MINI** con desagüe a pared convertible a suelo con curva técnica (4,5 LT) / Ensemble WC **BIG** avec évacuation murale transformable à terre avec courbe technique (4,5 LT) / Stand-Klosett WC **BIG** mit Wandabfluss, durch Kurventechnik auf Bodenabfluss umrüstbar (4,5 LT) / Унитаз моноблочный **BIG** Слив в стену при помощи технического колена трансформируется на слив в пол (4,5 LT)

**Size (cm)**

Medidas  
Dimensions  
Maße  
Размеры

**Product code**

Artículo  
Article  
Artikel  
Артикул

**Net weight (Kg)**

Peso neto  
Poids net  
Reingewicht  
вес нетто

**Finishes**

Acabados  
Finitions  
Farbe  
Отделки

**Euro**

Евро

**Pz.**

шт.  
pallet  
Italia

**Pz.**

шт.  
pallet  
Cont.

35 x 62 x 42 h

SMVMR(x)\*

31,05

Gloss White  
 Le Terre di Cielo\*

527,00  
971,00

9 + 9

12 + 12



## Cistern for monoblock wc

Tanque bajo para inodoro / Reservoir Mbl / Spülkasten / Бачок с установкой на унитаз для моноблочного унитаза

35 x 14 x 42 h

SMCMR(x)\*

12,30

Gloss White  
 Le Terre di Cielo\*

189,00  
352,00

+



## Discharge mechanism for cistern for monoblock wc SMCMR

Mecanismo de descarga para tanque bajo-inodoro SMCMR  
Mécanisme de descharge pour reservoir Mbl SMCMR  
Spülmachenismus für SMCMR  
Механизм двойного смыва для бачка SMCMR

SMMEC

2,45

Chrome

152,00



## Cistern for Smile monoblok with lid

Tanque bajo con tapa  
Smile reservoir pour ensemble wc 62 avec couvercle  
Smile Spülkasten Mini 62 mit Deckel  
Бачок моноблочный Smile с крышкой

35 x 14 x 42 h

SMCMC(x)\*

13,00

Gloss White  
 Le Terre di Cielo\*

185,00  
362,00

+



## Double flush discharge mechanism for SMCMC cistern

Bateria de descarga para tanque bajo-inodoro SMCMC  
Mécanisme double cache pour reservoir Mbl SMCMC  
Zweimengenablaufgarnitur für SMCMR  
Механизм двойного смыва для бачка SMCMC

FM

2,45

Chrome

86,00

	Size (cm) Medidas Dimensions Maße Размеры	Product code Artículo Article Artikel Артикул	Net weight(Kg) Peso neto Poïds net Reingewicht вес нетто	Finishes Acabados Finitions Farbe Отделки	Euro Евро	Pz. шт. pallet Italia	Pz. шт. pallet Cont.
 <p><b>Thermosetting hard close seat &amp; cover</b> Asiento para inodoro Abattant thermodurcissable Wc-sitz thermodur Сиденье из термоотверждающейся смолы</p>		CPVSM	2,30	<input type="radio"/> Gloss White	110,00		
 <p><b>Thermosetting contoured wrap lid soft close seat &amp; cover with quick release hinges</b> Asiento para inodoro amortiguado / Abattant thermodurcissable soft / Wc-sitz thermodur mit Abs. Сиденье из термоотверждающейся смолы, с плавным опусканием</p> <p><b>QUICK RELEASE HINGES</b> </p>		CPVSMF(X)*	2,30	<input type="radio"/> Gloss White <input type="radio"/> *X = TL - Talco <input checked="" type="radio"/> Le Terre di Cielo*	172,00 296,00 316,00		
 <p><b>Thermosetting slim double flap soft close seat &amp; cover with quick release hinges</b> Asiento para inodoro amortiguado bisagra con sistema extraible Abattant thermodurcissable soft avec charnières à ouverture Wc sitz in thermodur mit soft-closet und Takeoff Funktion Сиденье съемное из термоотверждающейся смолы с плавным опусканием</p> <p><b>QUICK RELEASE HINGES</b> </p>		CPVSMNEWF(X)*	2,30	<input type="radio"/> Gloss White <input type="radio"/> *X = TL - Talco <input checked="" type="radio"/> Le Terre di Cielo*	188,00 296,00 316,00		
 <p><b>Technical curve "floor trap" for toilet</b> Curva técnica "salida vertical" para inodoro / Courbe technique à S pour cuvette avec sortie au sol / WC-Ablaufbogen "S" / Колено "S"-образное для унитазов, регулируемое</p>		CSB	0,40		18,00		
 <p><b>Straight pan connector for wall trap</b> Anclaje a pared para inodoro / Pipe pour sortie horizontale / WC-Anschlussstutzen für Abgang waagerecht / Фитинг для выпуска в стену для унитазов</p>		RPB	0,35		15,00		
 <p><b>90° technical curve</b> Curva de técnica a noventa grado / Pipe d'évacuation à 90° / WC-Aublaufbogen 90 Grad / Колено 90° регулируемое</p>		CSR90	0,75		19,00		

## Technical symbols legend

Simbolos técnicos clave / Légende symboles techniques / Technische Zeichenerklärung / Перечень технических символов

 **bifunctional drain**  
descarga bifuncional  
évacuation bifonctionnelle  
Spülung mit zwei  
Montagevarianten  
функциональный бачок

 **back to wall installation**  
instalación a suelo  
installation à terre  
bodenstehende Montage  
напольная установка

 **with fixing parts**  
fijaciones incluidas  
fixations incluses  
inklusive Befestigungen  
в комплекте с крепежами

 **4,5 l toilet tank**  
descarga 4,5 lt  
évacuation à 4,5 l  
4,5 l-Spülung  
бачок на 4,5 л

 **quick release hinges**  
sistema extraible  
charnières à ouverture  
Takeoff Funktion  
Быстрый съем

\* Terre di Cielo finishes available for wc-bidet / Acabados Terre di Cielo disponibles para wc-bidet / Finitions Terre di Cielo disponibles pour cuvette-bidet / Für das WC/Bidet erhältliche Ausführungen Terre di Cielo / отделки Terre di Cielo доступны для унитаза и биде

TL - Talco 
  PM - Pomice 
  BR - Brina 
  AN - Arenaria 
  AV - Avena 
  CM - Cemento 
  BA - Basalto



# Enjoy

design Karim Rashid

indice collezione \ collection index pg. 485

listino prezzi \ price list pg. 486 - 493







## Washbasins finishes

Acabados de Lavabos  
Finitions des Lavabos  
Waschbecken Farbe  
Отделки Раковина

 Gloss White

## Le Terre di Cielo

-  TL - Talco
-  PM - Pomice
-  BR - Brina
-  CM - Cemento
-  BA - Basalto
-  LV - Lavagna
-  FN - Fango
-  CA - Cacao
-  AN - Arenaria
-  AV - Avena
-  MU - Muschio
-  AG - Agave
-  LN - Lino
-  CN - Canapa
-  CP - Cipria
-  PL - Polvere

## WC and Bidets finishes

Acabados de Sanitarios  
Finitions des WC et Bidets  
WC und Bidet Farbe  
Отделки Унитаз и Биде

 Gloss White

 TL - Talco

## Le Terre di Cielo

-  PM - Pomice
-  BR - Brina
-  AV - Avena
-  AN - Arenaria
-  CM - Cemento
-  BA - Basalto
-  LV - Lavagna  
(EJVS - EJVSK - EJBS -  
EJVSKR - EJBSR)

## Le Acque di Cielo

(EJVS-EJVSK-EJVSKR-EJBS-EJBSR)

-  OL - Oltremare
-  SM - Smeraldo
-  AL - Alga
-  CO - Corallo
-  NI - Ninfea
-  AM - Anemone

**The possible variations of the colour cannot be considered as defect, but as a guarantee of the completely artisan manufacturing of this unique and high quality product.**

*Las variaciones de colores no se consideran un defecto sino una garantía de una elaboración manual y artesanal en un producto único y de calidad.*

*Les éventuelles variations de couleur ne peuvent être considérées comme des défauts, elles témoignent en revanche d'une méthode de travail totalementement manuelle et artisanale employée pour obtenir un produit fini unique et de qualité.*

*Eventuelle Farbvariationen sind nicht als Mangel anzusehen, sondern als Garantie für die komplett handwerkliche Anfertigung eines einzigartigen und hochqualitativen Produkts.*

*Возможные вариации цвета не могут считаться дефектом, а являются подтверждением ручной работы, гарантией качества и уникальности изделия.*

## Lavabi / washbasins

**installazione sospesa o da piano**  
wall-hung or on top installation

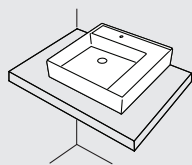
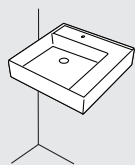

**EJLA50**  
design Karim Rashid  
50 x 48 x h12,5  
pag. 486

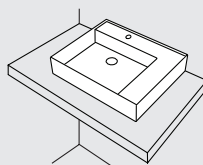
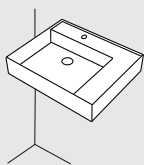

**EJLA60**  
design Karim Rashid  
60 x 48 x h12,5  
pag. 486

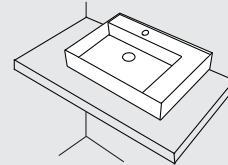
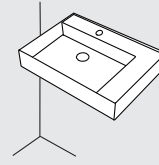

**EJLA70**  
design Karim Rashid  
70 x 48 x h12,5  
pag. 486

**installazione sottopiano**  
undercounter installation

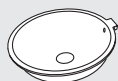

**EJLASPT**  
42 x 40,5 x h18,5  
pag. 486

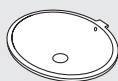

**EJLASPO**  
44,5 x 52 x h18,5  
pag. 486

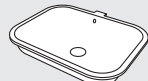

**EJLASPR**  
41,5 x 53 x h17,5  
pag. 486

**installazione semincasso**  
semirecessed installation



**EJLASIT**  
040 x h14  
pag. 487



**EJLASIQ**  
40 x 40 x h14  
pag. 487

## Wc - bidet

### ENJOY 53

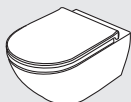

**EJVSK**  
design Karim Rashid  
**senza brida / rimless**  
35 x 53 x 26,5 h  
pag. 488

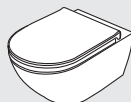

**EJVS**  
design Karim Rashid  
35 x 53 x 26,5 h  
pag. 488



**EJBS**  
design Karim Rashid  
35 x 53 x 26,5 h  
pag. 489

### ENJOY MINI 48

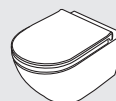

**EJVSKR**  
**senza brida / rimless**  
35 x 48 x 26,5 h  
pag. 492

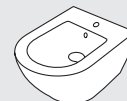







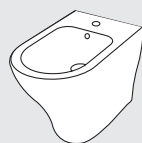











**EJBSR**  
35 x 48 x 26,5 h  
pag. 493































**EJVA**  
35 x 53 x 42 h  
pag. 490



**EJBI**  
35 x 53 x 42 h  
pag. 491













 	Size (cm)	Product code	Net weight(Kg)	Finishes	Euro	Pz.	Pz.	
	Medidas Dimensions Maße Размеры	Artículo Article Artikel Артикул	Peso neto Poids net Reingewicht вес нетто	Acabados Finitions Farbe Отделка	Евро	шт. pallet Italia	шт. pallet Cont.	
<b>Rectangular washbasin wall-hung installation</b> Lavabo suspendido rectangular Lavabo suspendu rectangulaire Hängender Waschbecken rechteckig Раковина подвесная на стену прямоугольная	70 x 48 x h12,5	EJLA70(X)* EJLA70SF(X)* no tap hole sin agujero - sans orifice - ohne Loch без отверстия	20,00	 Gloss White  Le Terre di Cielo	564,00 801,00	20	34	
	60 x 48 x h12,5	EJLA60(X)* EJLA60SF(X)* no tap hole sin agujero - sans orifice - ohne Loch без отверстия	18,00	 Gloss White  Le Terre di Cielo	527,00 738,00	20	40	
	50 x 48 x h12,5	EJLA50(X)* EJLA50SF(X)* no tap hole sin agujero - sans orifice - ohne Loch без отверстия	15,00	 Gloss White  Le Terre di Cielo	477,00 677,00	20	40	
<b>The washbasin is recommended for wall hung installation. For on top installation customers are advised to the require the "RETTIFICA" option.</b> Se recomienda la instalación del lavabo suspendido. Para instalaciones de apoyo se aconseja usar la opción "RETTIFICA". / La vasque est recommandée pour l'installation suspendu. Pour l'installation à poser on conseille l'option "RETTIFICA". / Es empfiehlt sich, das Waschbecken hängend zu installieren. Bei Aufsatzmontage bitte die Option "RETTIFICA" anfragen. / Данная раковина предназначена для подвесной установки. При установке на столешницу рекомендуется запросить опцию "RETTIFICA".					RETTIFICA GRINDING РЕКТИФИКАЦИЯ	10,00		
	42 x 40,5 x h18,5	EJLASPT(X)*	5,90	 Gloss White  Le Terre di Cielo	233,00 442,00	26	52	
<b>Undercounter round washbasin</b> Lavabo bajo encimera redondo / Vasque à encastrer par dessous ronde / Rundiges Unterbaubecken Раковина круглая встроенная под столешницу*								
	44,5 x 52 x h18,5	EJLASPO(X)*	7,45	 Gloss White  Le Terre di Cielo	238,00 456,00	20	34	
<b>Undercounter oval washbasin</b> Lavabo bajo encimera oval / Vasque à encastrer par dessous ovale / Ovales Unterbaubecken Раковина овальная встроенная под столешницу								
	41,5 x 53 x h17,5	EJLASPR(X)*	8,05	 Gloss White  Le Terre di Cielo	274,00 517,00	20	34	
<b>Undercounter rectangular washbasin</b> Lavabo bajo encimera rectangular / Vasque à encastrer par dessous rectangulaire / Rechteckiges Unterbaubecken / Раковина прямоугольная встроенная под столешницу								
	<b>Fixing system for undercounter washbasin</b> Fijaciones para lavabo bajo encimera / Fixations pour vasque à encastrer par dessous / Befestigungen für Unterbaubecken / Крепления для раковины для установки под столешницу		FISP	0,40	17,00			





















- Le Terre di Cielo
-  TL - Talco
  -  PM - Pomice
  -  BR - Brina
  -  BA - Basalto
  -  LV - Lavagna
  -  CM - Cemento
  -  FN - Fango
  -  CA - Cacao
  -  AN - Arenaria
  -  AV - Avena
  -  LN - Lino
  -  AG - Agave
  -  MU - Muschio
  -  PL - Polvere
  -  CP - Cipria
  -  CN - Canapa

	Size (cm)	Product code	Net weight (kg)	Finishes	Euro		Pz.
	Medidas Dimensions Maße Размеры	Artículo Article Artikel Артикул	Peso neto Poids net Reingewicht вес нетто	Acabados Finitions Farbe Отделки	Euro		шт. pallet Cont.
  <p><b>Semi-recessed round washbasin</b> Lavabo semiempotrado redondo / Vasque semi-encastree ronde / Rundiges Halbeinbaubecken / Раковина полустроенная круглая</p>	Ø40 x h14	EJLASIT(X)*	7,70	 <b>Gloss White</b>  <b>Le Terre di Cielo</b>	<b>392,00</b>	26	52
  <p><b>Semi-recessed square washbasin</b> Lavabo semiempotrado cuadrado / Vasque semi-encastree carrée / Quadrates Halbeinbaubecken / Раковина полустроенная квадратная</p>	40 x 40 x h14	EJLASIQ(X)*	9,65	 <b>Gloss White</b>  <b>Le Terre di Cielo</b>	<b>392,00</b>	26	52
 <p><b>Universal click/clack drain in CHROME with ceramic lid</b> Válvula universal click/clack Cromado con tapa en cerámica / Bonde universelle clic/clac Chromé avec clapet en céramique / Universal-Ablaufgarnitur Click-Clack Chrom mit Keramikstopfen / Универсальный донный клапан click/clack хром с керамической крышкой</p>		PIL01(X)*	0,40	 <b>Gloss White</b>  <b>Le Terre di Cielo</b>	<b>95,00</b>		
 <p><b>Universal click/clack drain in BLACK MATT finish with ceramic lid</b> Válvula universal click/clack Negro Matt con tapa en cerámica / Bonde universelle clic/clac Noir Mat avec clapet en céramique / Universal-Ablaufgarnitur Click-Clack Matt Schwarz mit Keramikstopfen / Универсальный донный клапан click/clack черный матовый с керамической крышкой</p>		PIL01NM(X)*	0,40	 <b>Gloss White</b>  <b>Le Terre di Cielo</b>	<b>120,00</b>		
 <p><b>Universal click/clack drain in CEMENTO finish with ceramic lid</b> Válvula universal click/clack Cemento con tapa en cerámica / Bonde universelle clic/clac Cemento avec clapet en céramique / Universal-Ablaufgarnitur Click-Clack Cement mit Keramikstopfen / Универсальный донный Cemento click/clack с керамической крышкой</p>		PIL01CM(X)*	0,40	 <b>Gloss White</b>  <b>Le Terre di Cielo</b>	<b>120,00</b>		
 <p><b>Universal click/clack drain in BRONZE with ceramic lid</b> Válvula universal click/clack Bronce con tapa en cerámica / Bonde universelle clic/clac Bronce avec clapet en céramique / Universal-Ablaufgarnitur Click-Clack Bronze mit Keramikstopfen / Универсальный донный клапан click/clack бронза с керамической крышкой</p>		PIL01BR(X)*	0,40	 <b>Gloss White</b>  <b>Le Terre di Cielo</b>	<b>135,00</b>		
 <p><b>CHROMED siphon</b> Sífone Cromado \ Siphon Chromé \ Siphon Verchromt \ сифон Chrome</p>		SISP	0,93	 <b>Chrome</b>	<b>133,00</b>		
 <p><b>MATT BLACK siphon</b> Sífone Negro Mate \ Siphon Noir Mat \ Siphon Schwarz Matt \ Сифон Черный матовый</p>		SIFN	0,93	 <b>Matt Black</b>	<b>194,00</b>		
 <p><b>CEMENTO siphon</b> Sífone Cemento \ Siphon Cemento \ Siphon Cemento \ сифон Cemento</p>		SIFCM	0,93	 <b>Cemento</b>	<b>194,00</b>		
 <p><b>BRONZE siphon</b> Sífone Bronce \ Siphon Bronce \ Siphon Bronze \ бронза сифон</p>		SIFBR	0,93	 <b>Bronze</b>	<b>220,00</b>		

## Technical symbols legend

Simbolos técnicos clave / Légende symboles techniques / Technische Zeichenerklärung / Перечень технических символов

 <p><b>one side is unglazed</b> con un lado sin esmaltar avec un côté non émaillé eine Seite unglasiert одна сторона не покрыта эмалью</p>	 <p><b>all sides are enamelled</b> con todos los lados esmaltados avec tous les côtés émaillés alle Seiten glasiert все стороны покрыты эмалью</p>	 <p><b>with 1 hole prepared 3 holes</b> avec un trou prédisposition à trois trous mit 1-Loch auf 3-Loch durchschlagbar одно отверстие с возможностью выполнения трех отверстий</p>	 <p><b>no tap holes</b> sin agujero para grifo sans orifice robinet ohne Hahnloch без отверстия под смеситель</p>	 <p><b>no tap hole on request</b> sin agujero, solo a petición sans orifice sur demande auf Anfrage ohne Loch без отверстия под смеситель по запросу</p>	 <p><b>with overflow</b> con rebosadero avec trop-plein mit Überlauf с переливом</p>
 <p><b>on top installation</b> instalación de apoyo installation à partir du plan Montage auf Platte установка на столешницу</p>	 <p><b>wall-hung installation</b> instalación suspendida installation suspendue wandhängende Montage подвесная установка</p>	 <p><b>fitted installation</b> instalación en encimera installation sous plan Unterbaumontage встраиваемая установка</p>	 <p><b>with fixing parts</b> fijaciones incluidas fixations incluses inklusive Befestigungen в комплекте с крепежами</p>	 <p><b>without overflow</b> sin rebosadero sans trop-plein ohne Überlauf без слива-перелива</p>	 <p><b>semi-recessed installation</b> instalación semiempotrada installation semi encastrée Halbeinbaumontage подвесная установка</p>

SENZA BRIDA \ RIMLESS	Size (cm)	Product code	Net weight(Kg)	Finishes	Euro	Pz.	Pz.
	Medidas Dimensions Maße Размеры	Artículo Article Artikel Артикул	Peso neto Poids net Reingewicht вес нетто	Acabados Finitions Farbe Отделки	Евро	шт. pallet Italia	шт. pallet Cont.
 <p><b>Wall-hung wc with fixing kit (4,5 LT) - rimless</b> Wc suspendido completo con fijaciones (4,5 LT) - <b>sin brida</b> / Wc suspendu avec fixations (4,5 LT) - <b>sans brida</b> Wand-WC mit Befestigungskit (4,5 lt.) - <b>ohne Spülrand</b> Подвесной унитаз в комплекте с крепежами (4,5 литр) - без ободка</p>	35 x 53 x 26,5 h	EJVSK(X)*	19,40	<ul style="list-style-type: none"> <li> <b>Gloss White</b></li> <li> <b>*X = TL - Talco</b></li> <li> <b>Le Terre di Cielo*</b></li> <li> <b>Le Acque di Cielo</b></li> </ul>	<b>378,00</b> <b>602,00</b> <b>613,00</b> <b>613,00</b>	18	18
 <p><b>Wall-hung wc with fixing kit (4,5 LT)</b> Wc suspendido completo con fijaciones (4,5 LT) Wc suspendu avec fixation (4,5 LT) Wand-WC mit Befestigungskit (4,5 LT) Унитаз подвесной в комплекте со крепежами (4,5 LT)</p>	35 x 53 x 26,5 h	EJVS(X)*	18,25	<ul style="list-style-type: none"> <li> <b>Gloss White</b></li> <li> <b>*X = TL - Talco</b></li> <li> <b>Le Terre di Cielo*</b></li> <li> <b>Le Acque di Cielo</b></li> </ul>	<b>370,00</b> <b>594,00</b> <b>613,00</b> <b>613,00</b>	18	18
 <p><b>Thermosetting hard close seat &amp; cover</b> Asiento para inodoro / Abattant thermodurcissable Wc-sitz thermotur / Сиденье из термоотверждающейся смолы</p>		CPVEJT	2,30	<ul style="list-style-type: none"> <li> <b>Gloss White</b></li> </ul>	<b>110,00</b>		
 <p><b>Thermosetting contoured wrap lid soft close seat &amp; cover with quick release hinges</b> Asiento para inodoro amortiguado / Abattant thermo durcissable soft / Wc-sitz thermotur mit Abs / Сиденье из термоотверждающейся смолы, с плавным опусканием</p>		CPVEJTF(X)*	2,30	<ul style="list-style-type: none"> <li> <b>Gloss White</b></li> </ul>	<b>172,00</b>		
 <p><b>Thermosetting slim double flap soft close seat &amp; cover with quick release hinges</b> Asiento para inodoro amortiguado bisagra con sistema extraíble Abattant thermodurcissable soft avec charnières à ouverture Wc sitz in thermotur mit soft-closet und Takeoff Funktion Сиденье съемное из термоотверждающейся смолы с плавным опусканием</p>		CPVEJNEWF(X)*	2,30	<ul style="list-style-type: none"> <li> <b>Gloss White</b></li> <li> <b>*X = TL - Talco</b></li> <li> <b>Le Terre di Cielo*</b></li> <li> <b>Le Acque di Cielo</b></li> </ul>	<b>188,00</b> <b>296,00</b> <b>316,00</b> <b>316,00</b>		
 <p><b>Impact and acoustic protection panel</b> Protección antigolpes y acústica / Protection acoustique et anti-choc / Stoss- und Schalldämmung / Противоударная и акустическая защита</p>		PAA	0,16		<b>17,00</b>		
 <p><b>Couple of fixing brackets for wall-hung wc/bidet</b> - Pareja de estribo para Inodoro/ Bidet suspendido / Étriers de fixation pour Wc/Bidet suspendus / 1 Paar Halterungen für wandhängendes Wc/Bidet / Монтажная рама для подвесного унитаза/биде</p>	3,3 x 18,5 x 55 h	508	2,00		<b>39,00</b>		

## Technical symbols legend

Simbolos técnicos clave / Légende symboles techniques / Technische Zeichenerklärung / Перечень технических символов



**with fixing parts**  
fijaciones incluidas  
fixations incluses  
inklusive Befestigungen  
в комплекте с крепежами



**wall-hung installation**  
instalación suspendida  
installation suspendue  
wandhängende Montage  
подвесная установка



**Combifix compatibility**  
compatible Combifix  
mit Combifix kompatibel  
совместим с combifix



**rimless**  
sin brida  
sans brida  
ohne Spülrand  
без ободка



**4,5 l toilet tank**  
descarga 4,5 lt  
évacuation à 4,5 l  
4,5 l-Spülung  
бачок на 4,5 л



**quick release hinges**  
sistema extraíble  
charnières à ouverture  
Takeoff Funktion  
быстрый съем

**Acque di Cielo finishes available for wc-bidet** / Acabados Acque di Cielo disponibles para wc-bidet / Finitions Acque di Cielo disponibles pour cuvette-bidet / Für das WC/Bidet erhältliche Ausführungen Acque di Cielo / отделки Acque di Cielo доступны для унитаза и биде

 **OL - Oltremare**  **SM - Smeraldo**  **AL - Alga**  **CO - Corallo**  **NI - Ninfea**  **AM - Anemone**

**\* Terre di Cielo finishes available for wc-bidet** / Acabados Terre di Cielo disponibles para wc-bidet / Finitions Terre di Cielo disponibles pour cuvette-bidet / Für das WC/Bidet erhältliche Ausführungen Terre di Cielo / отделки Terre di Cielo доступны для унитаза и биде

 **TL - Talco**  **PM - Pomice**  **BR - Brina**  **AN - Arenaria**  **AV - Avena**  **CM - Cemento**  **BA - Basalto**  **LV - Lavagna**



	Size (cm) Medidas Dimensions Maße Размеры	Product code Artículo Article Artikel Артикул	Net weight (kg) Peso neto Poids net Reingewicht вес нетто	Finishes Acabados Finitions Farbe Отделка	Euro Евро	Pz. шт. pallet Italia	Pz. шт. pallet Cont.
<b>Wall-hung one hole bidet with fixing kit</b> Bidé suspendido monoagujero completo con fijaciones Bidet suspendu monotrou avec fixation Wand-Bidet einloch mit Befestigungskit Биде подвесное с одним отверстием под смеситель, в комплекте с крепежами	35 x 53 x 26,5 h	EJBS(x)*	17,60	○ Gloss White ○ *X = TL - Talco ● Le Terre di Cielo* ● Le Acque di Cielo	370,00 594,00 613,00 613,00	18	18
<b>Impact and acoustic protection panel</b> Protección antigolpes y acústica / Protection acoustique et anti-choc / Stoss- und Schalldämmung / Противоударная и акустическая защита		PAA	0,16		17,00		
<b>Couple of fixing brackets for wall-hung wc/bidet</b> Pareja de estribo para Inodoro/Bidet suspendido / Étriers de fixation pour Wc/Bidet suspendus / 1 Paar Halterungen für wandhängendes Wc/Bidet / Монтажная рама для подвесного унитаза/биде	3,3 x 18,5 x 55 h	508	2,00		39,00		
<b>Universal click/clack drain in CHROME with ceramic lid</b> Válvula universal click/clack Cromado con tapa en cerámica Bonde universelle clic/clac Chromé avec clapet en céramique Universal-Ablaufgarnitur Click-Clack Chrom mit Keramikstopfen Универсальный донный клапан click/clack хром с керамической крышкой		PIL01(x)*	0,40	○ Gloss White	95,00		
				● Le Terre di Cielo	139,00		
				● Le Acque di Cielo	139,00		
<b>Universal click/clack drain in BLACK MATT finish with ceramic lid</b> Válvula universal click/clack Negro Matt con tapa en cerámica / Bonde universelle clic/clac Noir Mat avec clapet en céramique Universal-Ablaufgarnitur Click-Clack Matt Schwarz mit Keramikstopfen Универсальный донный клапан click/clack черный матовый с керамической крышкой		PIL01NM(x)*	0,40	○ Gloss White	120,00		
				● Le Terre di Cielo	169,00		
				● Le Acque di Cielo	169,00		
<b>Universal click/clack drain in CEMENTO finish with ceramic lid</b> Válvula universal click/clack Cemento con tapa en cerámica Bonde universelle clic/clac Cemento avec clapet en céramique Universal-Ablaufgarnitur Click-Clack Cement mit Keramikstopfen Универсальный донный Cemento click/clack с керамической крышкой		PIL01CM(x)*	0,40	○ Gloss White	120,00		
				● Le Terre di Cielo	169,00		
				● Le Acque di Cielo	169,00		
<b>Universal click/clack drain in BRONZE with ceramic lid</b> Válvula universal click/clack Bronce con tapa en cerámica Bonde universelle clic/clac Bronze avec clapet en céramique Universal-Ablaufgarnitur Click-Clack Bronze mit Keramikstopfen Универсальный донный клапан click/clack бронза с керамической крышкой		PIL01BR(x)*	0,40	○ Gloss White	135,00		
				● Le Terre di Cielo	182,00		
				● Le Acque di Cielo	182,00		

## Technical symbols legend

Simbolos técnicos clave | Légende symboles techniques |  
 Technische Zeichenerklärung | Перечень технических  
 символов

### with fixing parts

fijaciones incluidas  
 fixations incluses  
 inklusive Befestigungen  
 в комплекте с крепежами

### one tap hole

con 1 agujero  
 monotrou  
 1-Loch  
 одно отверстие под  
 смеситель

### with overflow

con rebosadero  
 avec trop-plein  
 mit Überlauf  
 с переливом

### wall-hung installation

instalación suspendida  
 installation suspendue  
 wandhängende Montage  
 подвесная установка

### Combifix compatibility

compatible Combifix  
 mit Combifix kompatibel  
 совместим с combifix

Acque di Cielo finishes available for wc-bidet | Acabados  
 Acque di Cielo disponibles para wc-bidet | Finitions Acque di Cielo  
 disponibles pour cuvette-bidet | Für das WC/Bidet erhältliche  
 Ausführungen Acque di Cielo | отделка Acque di Cielo доступны  
 для унитаза и биде

● OL - Oltremare ● SM - Smeraldo ● AL - Alga ● CO - Corallo ● NI - Ninfea ● AM - Anemone

\* Terre di Cielo finishes available for wc-bidet |  
 Acabados Terre di Cielo disponibles para wc-bidet | Finitions Terre di  
 Cielo disponibles pour cuvette-bidet | Für das WC/Bidet erhältliche  
 Ausführungen Terre di Cielo | отделка Terre di Cielo доступны для  
 унитаза и биде

○ TL - Talco ○ PM - Pomice ○ BR - Brina ○ AN - Arenaria ○ AV - Avena ○ CM - Cemento ○ BA - Basalto ○ LV - Lavagna





## Wc with horizontal outlet convertible to floor outlet by technical curve (4,5 LT)

Wc con desagüe a pared convertible a suelo con curva técnica (4,5 LT)  
 Wc avec évacuation murale transformable à terre avec courbe technique (4,5L)  
 WC mit Wandabfluss, durch Kurventechnik auf Bodenabfluss umrüstbar (4,5 LT)  
 Слив в стену при помощи технического колена трансформируется на слив в пол (4,5 л)

Size (cm)	Product code	Net weight(Kg)	Finishes	Euro	Pz.	Pz.
Medidas Dimensions Maße Размеры	Artículo Article Artikel Артикул	Peso neto Poids net Reingewicht вес нетто	Acabados Finitions Farbe Отделки	Евро	шт. pallet Italia	шт. pallet Cont.
35 x 53 x 42 h	EJVA(X)*	25,80	○ Gloss White ○ *X = TL - Talco ● Le Terre di Cielo*	329,00 570,00 596,00	18	20
	CPVEJT	2,30	○ Gloss White	110,00		
	CPVEJTF(X)*	2,30	○ Gloss White	172,00		
	CPVEJNEWF(X)*	2,30	○ Gloss White ○ *X = TL - Talco ● Le Terre di Cielo*	188,00 296,00 316,00		
	CSB	0,40		18,00		
	RPB	0,35		15,00		



## Thermosetting hard close seat & cover

Asiento para inodoro / Abattant thermodurcissable  
 Wc-sitz thermodur / Сиденье из термоотверждающейся смолы



## QUICK RELEASE HINGES

## Thermosetting contoured wrap lid soft close seat & cover with quick release hinges

Asiento para inodoro amortiguado / Abattant thermo durcissable soft / Wc-sitz thermodur mit Abs / Сиденье из термоотверждающейся смолы, с плавным опусканием



## QUICK RELEASE HINGES

## Thermosetting slim double flap soft close seat & cover with quick release hinges

Asiento para inodoro amortiguado bisagra con sistema extraible  
 Abattant thermodurcissable soft avec charnières à ouverture  
 Wc sitzt in thermodur mit soft-closet und Takeoff Funktion  
 Сиденье съемное из термоотверждающейся смолы с плавным опусканием



## Technical curve "floor trap" for toilet

Curva técnica "salida vertical" para inodoro / Courbe technique à S pour cuvette avec sortie au sol / WC-Ablaufbogen "S" / олено "S"-образное для унитазов, регулируемое



## Straight pan connector for wall trap

Anclaje a pared para inodoro / Pipe pour sortie horizontale / WC-Anschlussstutzen für Abgang waagerecht / Фитинг для выпуска в стену для унитазов

### Technical symbols legend

Simbolos técnicos clave / Légende symboles techniques / Technische Zeichenerklärung / Перечень технических символов

**bifunctional drain**  
 descarga bifuncional  
 évacuation bifonctionnelle  
 Spülung mit zwei  
 Montagevarianten  
 функциональный бачок

**back to wall installation**  
 instalación a suelo  
 installation à terre  
 bodenstehende Montage  
 напольная установка

**with fixing parts**  
 fijaciones incluidas  
 fixations incluses  
 inklusive Befestigungen  
 в комплекте с крепежами

**4,5 l toilet tank**  
 descarga 4,5 l  
 évacuation à 4,5 l  
 4,5 l-Spülung  
 бачок на 4,5 л

**quick release hinges**  
 sistema extraible  
 charnières à ouverture  
 Takeoff Funktion  
 быстрый съем

\* Terre di Cielo finishes available for wc-bidet / Acabados Terre di Cielo disponibles para wc-bidet / Finitions Terre di Cielo disponibles pour cuvette-bidet / Für das WC/Bidet erhältliche Ausführungen Terre di Cielo / Отделка Terre di Cielo доступны для унитаза и биде

○ TL - Talco ○ PM - Pomice ● BR - Brina ● AN - Arenaria ● AV - Avena ● CM - Cemento ● BA - Basalto



## Back to wall one hole bidet

Bidé a suelo monoagujero  
Bidet monotrou  
Stand-Bidet einloch  
Биде напольное с одним отверстием под смеситель

Size (cm) Medidas Dimensions Maße Размеры	Product code Artículo Article Artikel Артикул	Net weight (Kg) Peso neto Poïds net Reingewicht вес нетто	Finishes Acabados Finitions Farbe Отделки	Euro Евро	Pz. шт. pallet Italia	Pz. шт. pallet Cont.
35 x 53 x 42 h	EJBI(X)*	23,50	<ul style="list-style-type: none"> <li><span style="display: inline-block; width: 10px; height: 10px; border: 1px solid black; border-radius: 50%; background-color: white; margin-right: 5px;"></span> Gloss White</li> <li><span style="display: inline-block; width: 10px; height: 10px; border: 1px solid black; border-radius: 50%; background-color: #cccccc; margin-right: 5px;"></span> *X = TL - Talco</li> <li><span style="display: inline-block; width: 10px; height: 10px; border: 1px solid black; border-radius: 50%; background-color: #663333; margin-right: 5px;"></span> Le Terre di Cielo*</li> </ul>	329,00 570,00 596,00	18	20
 <b>Universal click/clack drain in CHROME with ceramic lid</b> Válvula universal click/clack Cromado con tapa en cerámica Bonde universelle clic/clac Chromé avec clapet en céramique Universal-Abflussgarnitur Click-Clack Chrom mit Keramikstopfen Универсальный дренажный клапан click/clack хром с керамической крышкой	PIL01(X)*	0,40	<ul style="list-style-type: none"> <li><span style="display: inline-block; width: 10px; height: 10px; border: 1px solid black; border-radius: 50%; background-color: white; margin-right: 5px;"></span> Gloss White</li> <li><span style="display: inline-block; width: 10px; height: 10px; border: 1px solid black; border-radius: 50%; background-color: #663333; margin-right: 5px;"></span> Le Terre di Cielo</li> </ul>	95,00 139,00		
 <b>Universal click/clack drain in BLACK MATT finish with ceramic lid</b> Válvula universal click/clack Negro Matt con tapa en cerámica / Bonde universelle clic/clac Noir Mat avec clapet en céramique Universal-Abflussgarnitur Click-Clack Matt Schwarz mit Keramikstopfen Универсальный дренажный клапан click/clack черный матовый с керамической крышкой	PIL01NM(X)*	0,40	<ul style="list-style-type: none"> <li><span style="display: inline-block; width: 10px; height: 10px; border: 1px solid black; border-radius: 50%; background-color: white; margin-right: 5px;"></span> Gloss White</li> <li><span style="display: inline-block; width: 10px; height: 10px; border: 1px solid black; border-radius: 50%; background-color: #663333; margin-right: 5px;"></span> Le Terre di Cielo</li> </ul>	120,00 169,00		
 <b>Universal click/clack drain in CEMENTO finish with ceramic lid</b> Válvula universal click/clack Cemento con tapa en cerámica Bonde universelle clic/clac Cemento avec clapet en céramique Universal-Abflussgarnitur Click-Clack Cement mit Keramikstopfen Универсальный дренажный клапан Cemento click/clack с керамической крышкой	PIL01CM(X)*	0,40	<ul style="list-style-type: none"> <li><span style="display: inline-block; width: 10px; height: 10px; border: 1px solid black; border-radius: 50%; background-color: white; margin-right: 5px;"></span> Gloss White</li> <li><span style="display: inline-block; width: 10px; height: 10px; border: 1px solid black; border-radius: 50%; background-color: #663333; margin-right: 5px;"></span> Le Terre di Cielo</li> </ul>	120,00 169,00		
 <b>Universal click/clack drain in BRONZE finish with ceramic lid</b> Válvula universal click/clack Bronce con tapa en cerámica Bonde universelle clic/clac Bronze avec clapet en céramique Universal-Abflussgarnitur Click-Clack Bronze mit Keramikstopfen Универсальный дренажный клапан click/clack бронза с керамической крышкой	PIL01BR(X)*	0,40	<ul style="list-style-type: none"> <li><span style="display: inline-block; width: 10px; height: 10px; border: 1px solid black; border-radius: 50%; background-color: white; margin-right: 5px;"></span> Gloss White</li> <li><span style="display: inline-block; width: 10px; height: 10px; border: 1px solid black; border-radius: 50%; background-color: #663333; margin-right: 5px;"></span> Le Terre di Cielo</li> </ul>	135,00 182,00		

### Technical symbols legend

Simbolos técnicos clave | Légende symboles techniques | Technische Zeichenerklärung | Перечень технических символов







-  **one tap hole**  
con 1 agujero  
monotrou  
1-Loch  
одно отверстие под смеситель
-  **with overflow**  
con rebosadero  
avec trop-plein  
mit Überlauf  
с переливом
-  **with fixing parts**  
fijaciones incluidas  
fixations incluses  
inklusive Befestigungen  
в комплекте с крепежами
-  **back to wall installation**  
instalación a suelo  
installation à terre  
bodenstehende Montage  
напольная установка

\* Terre di Cielo finishes available for wc-bidet / Acabados Terre di Cielo disponibles para wc-bidet / Finitions Terre di Cielo disponibles pour cuvette-bidet / Für das WC/Bidet erhältliche Ausführungen Terre di Cielo / отделки Terre di Cielo доступны для унитаза и биде

● TL - Talco ● PM - Pomice ● BR - Brina ● AN - Arenaria ● AV - Avena ● CM - Cemento ● BA - Basalto

# Enjoy Mini 48 - wc

# cielo

 <p>   <b>SENZA BRIDA \ RIMLESS</b> </p>	<b>Size (cm)</b> Medidas Dimensions Maße Размеры	<b>Product code</b> Artículo Article Artikel Артикул	<b>Net weight (Kg)</b> Peso neto Poids net Reingewicht вес нетто	<b>Finishes</b> Acabados Finitions Farbe Отделка	<b>Euro</b> Евро	<b>Pz.</b> шт. pallet Italia	<b>Pz.</b> шт. pallet Cont.
<b>Wall-hung wc with fixing kit (4,5 LT) - rimless *</b> Wc suspendido completo con fijaciones (4,5 LT) - sin brida / Wc suspendu avec fixations (4,5 LT) - sans bride Wand-WC mit BefestigungsKit (4,5 lt.) - ohne Spülrand Подвесной унитаз в комплекте с крепежами (4,5 литр) - без ободка	35 x 48 x 26,5 h	EJVSKR(X)*	17,00	● Gloss White ● *X = TL - Talco ● Le Terre di Cielo* ● Le Acque di Cielo	396,00 623,00 648,00 648,00	18	18
 <b>Thermosetting hard close seat &amp; cover</b> Asiento para inodoro Abattant thermodurcissable Wc-sitz thermodur Сиденье из термоотверждающейся смолы		CPVEJT	2,30	● Gloss White	110,00		
 <b>Thermosetting contoured wrap lid soft close seat &amp; cover with quick release hinges</b> Asiento para inodoro amortiguado / Abattant thermo durcissable soft / Wc-sitz thermodur mit Abs / Сиденье из термоотверждающейся смолы, с плавным опусканием		CPVEJTF(X)*	2,30	● Gloss White	172,00		
 <b>Thermosetting slim double flap soft close seat &amp; cover with quick release hinges</b> Asiento para inodoro amortiguado bisagra con sistema extraible Abattant thermodurcissable soft avec charnières à ouverture Wc-sitz in thermodur mit soft-closet und Takeoff Funktion Сиденье съемное из термоотверждающейся смолы с плавным опусканием		CPVEJNEWF(X)*	2,30	● Gloss White ● *X = TL - Talco ● Le Terre di Cielo* ● Le Acque di Cielo	188,00 296,00 316,00 316,00		
 <b>Impact and acoustic protection panel</b> Protección antigolpes y acústica / Protection acoustique et anti-choc / Stoss-und Schalldämmung Противоударная и акустическая защита	3,3 x 18,5 x 55 h	PAA	0,16		17,00		
 <b>Couple of fixing brackets for wall-hung wc/bidet</b> Pareja de estribo para Inodoro/Bidet suspendido / Étriers de fixation pour Wc/Bidet suspendus / 1 Paar Halterungen für wandhängendes Wc/Bidet / Монтажная рама для подвесного унитаза/биде		508	2,00		39,00		

## Technical symbols legend

Simbolos técnicos clave | Légende symboles techniques | Technische Zeichenerklärung | Перечень технических символов

**with fixing parts**  
 fijaciones incluidas  
 fixations incluses  
 inklusive Befestigungen  
 в комплекте с крепежами

**4,5 l toilet tank**  
 descarga 4,5 lt  
 évacuation à 4,5 l  
 4,5 l-Spülung  
 бак на 4,5 л

**quick release hinges**  
 sistema extraíble  
 charnières à ouverture  
 Takeoff Funktion  
 быстрый съем

**Combifix compatibility**  
 compatible Combifix  
 mit Combifix kompatibel  
 совместим с combifix

**rimless**  
 sin brida  
 sans bride  
 ohne Spülrand  
 без ободка

**wall-hung installation**  
 instalación suspendida  
 installation suspendue  
 wandhängende Montage  
 подвесная установка

### Acque di Cielo finishes available for wc-bidet / Acabados

Acque di Cielo disponibles para wc-bidet / Finitions Acque di Cielo disponibles pour cuvette-bidet / Für das WC/Bidet erhältliche Ausführungen Acque di Cielo / отделки Acque di Cielo доступны для унитаза и биде

● OL - Oltremare ● SM - Smeraldo ● AL - Alga ● CO - Corallo ● NI - Ninfea ● AM - Anemone

### \* Terre di Cielo finishes available for wc-bidet /

Acabados Terre di Cielo disponibles para wc-bidet / Finitions Terre di Cielo disponibles pour cuvette-bidet / Für das WC/Bidet erhältliche Ausführungen Terre di Cielo / отделки Terre di Cielo доступны для унитаза и биде

● TL - Talco ● PM - Pomice ● BR - Brina ● AN - Arenaria ● AV - Avena ● CM - Cemento ● BA - Basalto ● LV - Lavagna

# Enjoy Mini 48 - bidet

# cielo



## Wall-hung one hole bidet with fixing kit \*

Bidé suspendido monoagujero completo con fijaciones  
Bidet suspendu monotrou avec fixation  
Wand-Bidet einloch mit Befestigungskit  
Биде подвесное с одним отверстием под смеситель, в комплекте с крепежами

Size (cm)	Product code	Net weight(Kg)	Finishes	Euro	Pz.	Pz.
Medidas Dimensions Maße Размеры	Artículo Article Artikel Артикул	Peso neto Poïds net Reingewicht вес нетто	Acabados Finitions Farbe Отделки	Евро	шт. pallet Italia	шт. pallet Cont.
35 x 48 x 26,5 h	EJBSR(X)*	16,00	<ul style="list-style-type: none"> <li><span style="display: inline-block; width: 10px; height: 10px; border: 1px solid black; border-radius: 50%; background-color: white; margin-right: 5px;"></span> Gloss White</li> <li><span style="display: inline-block; width: 10px; height: 10px; border: 1px solid black; border-radius: 50%; background-color: #cccccc; margin-right: 5px;"></span> *X = TL - Talco</li> <li><span style="display: inline-block; width: 10px; height: 10px; border: 1px solid black; border-radius: 50%; background-color: #808080; margin-right: 5px;"></span> Le Terre di Cielo*</li> <li><span style="display: inline-block; width: 10px; height: 10px; border: 1px solid black; border-radius: 50%; background-color: #008080; margin-right: 5px;"></span> Le Acque di Cielo</li> </ul>	359,00 566,00 602,00 602,00	18	18

## Impact and acoustic protection panel

Protección antigolpes y acústica /  
Protection acoustique et anti-choc / Stoss-  
und Schalldämmung / Противоударная и  
акустическая защита



	PAA	0,16		17,00		
--	-----	------	--	-------	--	--

## Couple of fixing brackets for wall-hung wc/bidet -

Pareja de estribo para Inodoro/Bidet suspendido / Étriers de fixation pour Wc/Bidet suspendus / 1 Paar Halterungen für wandhängendes Wc/Bidet / Монтажная рама для подвесного унитаза/ биде



3,3 x 18,5 x 55 h	508	2,00		39,00		
-------------------	-----	------	--	-------	--	--

## Universal click/clack drain in CHROME with ceramic lid

Válvula universal click/clack Cromado con tapa en cerámica  
Bonde universelle clic/clac Chromé avec clapet en céramique  
Universal-Abflussgarnitur Click-Clack Chrom mit Keramikstopfen  
Универсальный донный клапан click/clack хром с керамической крышкой



PIL01(X)*	0,40	<span style="display: inline-block; width: 10px; height: 10px; border: 1px solid black; border-radius: 50%; background-color: white; margin-right: 5px;"></span> Gloss White	95,00
		<span style="display: inline-block; width: 10px; height: 10px; border: 1px solid black; border-radius: 50%; background-color: #808080; margin-right: 5px;"></span> Le Terre di Cielo	139,00
		<span style="display: inline-block; width: 10px; height: 10px; border: 1px solid black; border-radius: 50%; background-color: #008080; margin-right: 5px;"></span> Le Acque di Cielo	139,00

## Universal click/clack drain in BLACK MATT finish with ceramic lid

Válvula universal click/clack Negro Matt con tapa en cerámica  
Bonde universelle clic/clac Noir Mat avec clapet en céramique  
Universal-Abflussgarnitur Click-Clack Matt Schwarz mit Keramikstopfen  
Универсальный донный клапан click/clack черный матовый с керамической крышкой



PIL01NM(X)*	0,40	<span style="display: inline-block; width: 10px; height: 10px; border: 1px solid black; border-radius: 50%; background-color: white; margin-right: 5px;"></span> Gloss White	120,00
		<span style="display: inline-block; width: 10px; height: 10px; border: 1px solid black; border-radius: 50%; background-color: #808080; margin-right: 5px;"></span> Le Terre di Cielo	169,00
		<span style="display: inline-block; width: 10px; height: 10px; border: 1px solid black; border-radius: 50%; background-color: #008080; margin-right: 5px;"></span> Le Acque di Cielo	169,00

## Universal click/clack drain in CEMENTO finish with ceramic lid

Válvula universal click/clack Cemento con tapa en cerámica  
Bonde universelle clic/clac Cimento avec clapet en céramique  
Universal-Abflussgarnitur Click-Clack Cement mit Keramikstopfen  
Универсальный донный Cimento click/clack с керамической крышкой



PIL01CM(X)*	0,40	<span style="display: inline-block; width: 10px; height: 10px; border: 1px solid black; border-radius: 50%; background-color: white; margin-right: 5px;"></span> Gloss White	120,00
		<span style="display: inline-block; width: 10px; height: 10px; border: 1px solid black; border-radius: 50%; background-color: #808080; margin-right: 5px;"></span> Le Terre di Cielo	169,00
		<span style="display: inline-block; width: 10px; height: 10px; border: 1px solid black; border-radius: 50%; background-color: #008080; margin-right: 5px;"></span> Le Acque di Cielo	169,00

## Universal click/clack drain in BRONZE with ceramic lid

Válvula universal click/clack Bronce con tapa en cerámica  
Bonde universelle clic/clac Bronze avec clapet en céramique  
Universal-Abflussgarnitur Click-Clack Bronze mit Keramikstopfen  
Универсальный донный клапан click/clack бронза с керамической крышкой



PIL01BR(X)*	0,40	<span style="display: inline-block; width: 10px; height: 10px; border: 1px solid black; border-radius: 50%; background-color: white; margin-right: 5px;"></span> Gloss White	135,00
		<span style="display: inline-block; width: 10px; height: 10px; border: 1px solid black; border-radius: 50%; background-color: #808080; margin-right: 5px;"></span> Le Terre di Cielo	182,00
		<span style="display: inline-block; width: 10px; height: 10px; border: 1px solid black; border-radius: 50%; background-color: #008080; margin-right: 5px;"></span> Le Acque di Cielo	182,00

## Technical symbols legend

Simbolos técnicos clave / Légende symboles techniques / Technische Zeichenerklärung / Перечень технических символов

**with fixing parts**  
Fijaciones incluidas  
fixations incluses  
inklusive Befestigungen  
в комплекте с крепежами

**one tap hole**  
con 1 agujero  
monotrou  
1-Loch  
одно отверстие под  
смеситель

**with overflow**  
con rebosadero  
avec trop-plein  
mit Überlauf  
с переливом

**wall-hung installation**  
instalación suspendida  
installation suspendue  
wandhängende Montage  
подвесная установка

**Combifix compatibility**  
compatible Combifix  
mit Combifix kompatibel  
совместим с combifix

Acque di Cielo finishes available for wc-bidet / Acabados Acque di Cielo disponibles para wc-bidet / Finitions Acque di Cielo disponibles pour cuvette-bidet / Für das WC/Bidet erhältliche Ausführungen Acque di Cielo / отделки Acque di Cielo доступны для унитаза и биде

OL - Oltremare  SM - Smeraldo  AL - Alga  CO - Corallo  NI - Ninfea  AM - Anemone

\* Terre di Cielo finishes available for wc-bidet / Acabados Terre di Cielo disponibles para wc-bidet / Finitions Terre di Cielo disponibles pour cuvette-bidet / Für das WC/Bidet erhältliche Ausführungen Terre di Cielo / отделки Terre di Cielo доступны для унитаза и биде

TL - Talco  PM - Pomice  BR - Brina  AN - Arenaria  AV - Avena  CM - Cemento  BA - Basalto  LV - Lavagna



# Fluid

design Marco Piva

indice collezione \ collection index pg. 499

listino prezzi \ price list pg. 500 - 507







## Washbasins finishes (FLFREEC - FLFREEP - FLLA60 - FLLA45)

Acabados de Lavabos (FLFREEC - FLFREEP - FLLA60 - FLLA45)

Finitions des Lavabos (FLFREEC - FLFREEP - FLLA60 - FLLA45)

Waschbecken Farbe (FLFREEC - FLFREEP - FLLA60 - FLLA45)

Отделки Раковина (FLFREEC - FLFREEP - FLLA60 - FLLA45)

- Gloss White
- N - Gloss Black

### Le Terre di Cielo

- TL - Talco
- PM - Pomice
- BR - Brina
- CM - Cemento
- BA - Basalto
- LV - Lavagna
- FN - Fango
- CA - Cacao
- AN - Arenaria
- AV - Avena
- MU - Muschio
- AG - Agave
- LN - Lino
- CN - Canapa
- CP - Cipria
- PL - Polvere

## WC and Bidets finishes

Acabados de Sanitarios

Finitions des WC et Bidets

WC und Bidet Farbe

Отделки Унитаз и Биде

- Gloss White
- N - Gloss Black
- TL - Talco

### Le Terre di Cielo

- PM - Pomice
- BR - Brina
- AV - Avena
- AN - Arenaria
- CM - Cemento
- BA - Basalto

**The possible variations of the colour cannot be considered as defect, but as a guarantee of the completely artisan manufacturing of this unique and high quality product.**

*Las variaciones de colores no se consideran un defecto sino una garantía de una elaboración manual y artesanal en un producto único y de calidad.*

*Les éventuelles variations de couleur ne peuvent être considérées comme des défauts, elles témoignent en revanche d'une méthode de travail totalement manuelle et artisanale employée pour obtenir un produit fini unique et de qualité.*

*Eventuelle Farbvariationen sind nicht als Mangel anzusehen, sondern als Garantie für die komplett handwerkliche Anfertigung eines einzigartigen und hochqualitativen Produkts.*

*Возможные вариации цвета не могут считаться дефектом, а являются подтверждением ручной работы, гарантией качества и уникальности изделия.*

## Lavabi / washbasins



**FLFREEC**  
45 x 45 x 82 h  
pag. 500



**FLFREEP**  
45 x 45 x 82 h  
pag. 500



**FLLA60**  
60 x 45 x 14,5 h  
pag. 501



**FLLA45**  
45 x 45 x 14,5 h  
pag. 501

## Wc - bidet



**FLVS**  
37 x 53 x 37 h  
pag. 502

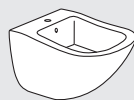

**FLBS**  
37 x 53 x 37 h  
pag. 503



**FLVA**  
37 x 53 x 41,5 h  
pag. 504



**FLBI**  
37 x 53 x 41,5 h  
pag. 505









**FLVM + FLCM**  
37 x 68 x 85,5 h  
pag. 506

# Fluid

washbasins / lavabi / Aufsatzbecken / Раковина

# cielo

	Size (cm)	Product code	Net weight (Kg)	Finishes	Euro	Pz.	Pz.
	Medidas Dimensions Maße Размеры	Artículo Article Artikel Артикул	Peso neto Poids net Reingewicht вес нетто	Acabados Finitions Farbe Отделка	Евро	шт. pallet Italia	шт. pallet Cont.
 <p><b>Freestanding washbasin - room centre installation</b>                      Installation lavabo freestanding instalación en el centro del cuarto                      Lavabo sur pied à installer en milieu de pièce                      Freistehender Säulenwaschtisch Montage in der Bad- Mitte                      Раковина отдельностоящая, установка по центру комнаты</p>	45 x 45 x 82 h	FLFREEC(X)*	38,90	● Gloss White ● *X = N - Gloss Black ● Le Terre di Cielo	1738,00 2176,00 2703,00	4	8
 <p><b>Freestanding washbasin - back to wall installation</b>                      Lavabo freestanding instalación a pared                      Lavabo sur pied à installer au mur                      Freistehender Säulenwaschtisch Montage an der Wand                      Раковина отдельностоящая, пристенная установка</p>	45 x 45 x 82 h	FLFREEP(X)*	38,90	● Gloss White ● *X = N - Gloss Black ● Le Terre di Cielo	1738,00 2176,00 2703,00	4	8
 <p><b>Universal click/clack drain in CHROME with ceramic lid</b>                      Válvula universal click/clack Cromado con tapa en cerámica                      Bonde universelle clic/clac Chromé avec clapet en céramique                      Universal-Abflussgarnitur Click-Clack Chrom mit Keramikstopfen                      Универсальный донный клапан click/clack хром с керамической крышкой</p>		PIL01(X)*	0,40	● Gloss White ● *X = N - Gloss Black ● Le Terre di Cielo	95,00 114,00 139,00		
 <p><b>Universal click/clack drain in BLACK MATT finish with ceramic lid</b>                      Válvula universal click/clack Negro Matt con tapa en cerámica                      Bonde universelle clic/clac Noir Mat avec clapet en céramique                      Universal-Abflussgarnitur Click-Clack Matt Schwarz mit Keramikstopfen                      Универсальный донный клапан click/clack черный матовый с керамической крышкой</p>		PIL01NM(X)*	0,40	● Gloss White ● *X = N - Gloss Black ● Le Terre di Cielo	120,00 159,00 169,00		
 <p><b>Universal click/clack drain in CEMENTO finish with ceramic lid</b>                      Válvula universal click/clack Cemento con tapa en cerámica                      Bonde universelle clic/clac Cemento avec clapet en céramique                      Universal-Abflussgarnitur Click-Clack Cement mit Keramikstopfen                      Универсальный донный Cemento click/clack с керамической крышкой</p>		PIL01CM(X)*	0,40	● Gloss White ● *X = N - Gloss Black ● Le Terre di Cielo	120,00 159,00 169,00		
 <p><b>Universal click/clack drain in BRONZE with ceramic lid</b>                      Válvula universal click/clack Bronce con tapa en cerámica                      Bonde universelle clic/clac Bronze avec clapet en céramique                      Universal-Abflussgarnitur Click-Clack Bronze mit Keramikstopfen                      Универсальный донный клапан click/clack бронза с керамической крышкой</p>		PIL01BR(X)*	0,40	● Gloss White ● *X = N - Gloss Black ● Le Terre di Cielo	135,00 171,00 182,00		

## Technical symbols legend

Simbolos técnicos clave / Légende symboles techniques / Technische Zeichenerklärung / Перечень технических символов











 <p><b>all sides are enamelled</b>                      con todos los lados                      avec tous les côtés                      émaillés                      alle Seiten glasiert                      все стороны                      глазурированные</p>	 <p><b>no tap holes</b>                      sin agujero para grifo                      sans orifice robinet                      ohne Hahnloch                      все стороны покрыты                      эмалью</p>	 <p><b>without overflow</b>                      sin rebosadero                      sans trop-plein                      ohne Überlauf                      без слива-перелива</p>	 <p><b>back to wall freestanding installation</b>                      instalación freestanding a pared                      installation autoportante murale                      freistehende Montage an der                      Wand                      свободная установка                      пристенная установка</p>	 <p><b>room centre freestanding installation</b>                      instalación freestanding centro                      habitación                      installation autoportante centre                      pièce                      freistehende Montage in der                      Raummitte                      свободная установка                      по центру комнаты</p>	 <p><b>with fixing parts</b>                      fijaciones incluidas                      fixations incluses                      inklusive                      Befestigungen                      в комплекте с                      крепежами</p>	 <p><b>with technical joint or siphon</b>                      completo de curva/sifón                      fourni avec raccord courbé                      / siphon                      komplett mit Rohrbogen/ Siphon                      в комплекте с коленом /                      сифоном</p>
--	--	--	--	---	---	---

Le Terre di Cielo	● TL - Talco	● PM - Pomice	● BR - Brina	● BA - Basalto	● LV - Lavagna	● CM - Cemento	● FN - Fango	● CA - Cacao
	● AN - Arenaria	● AV - Avena	● LN - Lino	● AG - Agave	● MU - Muschio	● PL - Polvere	● CP - Cipria	● CN - Canapa

# Fluid

washbasins / lavabi / Aufsatzbecken / Раковина

# cielo

	Size (cm) Medidas Dimensions Maße Размеры	Product code Artículo Article Artikel Артикул	Net weight (Kg) Peso neto Poids net Reingewicht вес нетто	Finishes Acabados Finitions Farbe Отделки	Euro Евро	Pz. шт. pallet Italia	Pz. шт. pallet Cont.
 <p><b>On top washbasin 60</b> Lavabo sobre encimera 60 Lavabo à poser 60 Aufsatzbecken 60 Раковина накладная 60</p>	60 x 45 x 14,5 h	FLLA60(X)*	13,30	<ul style="list-style-type: none"> <li>Gloss White</li> <li>*X = N - Gloss Black</li> <li>Le Terre di Cielo</li> </ul>	<ul style="list-style-type: none"> <li>373,00</li> <li>483,00</li> <li>622,00</li> </ul>	16	32
 <p><b>On top washbasin 45</b> Lavabo sobre encimera 45 Lavabo à poser 45 Aufsatzbecken 45 Раковина накладная 45</p>	45 x 45 x 14,5 h	FLLA45(X)*	10,30	<ul style="list-style-type: none"> <li>Gloss White</li> <li>*X = N - Gloss Black</li> <li>Le Terre di Cielo</li> </ul>	<ul style="list-style-type: none"> <li>285,00</li> <li>375,00</li> <li>532,00</li> </ul>	20	34
 <p><b>Universal click/clack drain in CHROME with ceramic lid</b> Válvula universal click/clack Cromado con tapa en cerámica Bonde universelle clic/clac Chromé avec clapet en céramique Universal-Abflussgarnitur Click-Clack Chrom mit Keramikstopfen Универсальный донный клапан click/clack хром с керамической крышкой</p>		PIL01(X)*	0,40	<ul style="list-style-type: none"> <li>Gloss White</li> <li>*X = N - Gloss Black</li> <li>Le Terre di Cielo</li> </ul>	<ul style="list-style-type: none"> <li>95,00</li> <li>114,00</li> <li>139,00</li> </ul>		
 <p><b>Universal click/clack drain in BLACK MATT finish with ceramic lid</b> Válvula universal click/clack Negro Matt con tapa en cerámica Bonde universelle clic/clac Noir Mat avec clapet en céramique Universal-Abflussgarnitur Click-Clack Matt Schwarz mit Keramikstopfen Универсальный донный клапан click/clack черный матовый с керамической крышкой</p>		PIL01NM(X)*	0,40	<ul style="list-style-type: none"> <li>Gloss White</li> <li>*X = N - Gloss Black</li> <li>Le Terre di Cielo</li> </ul>	<ul style="list-style-type: none"> <li>120,00</li> <li>159,00</li> <li>169,00</li> </ul>		
 <p><b>Universal click/clack drain in CEMENTO finish with ceramic lid</b> Válvula universal click/clack Cemento con tapa en cerámica Bonde universelle clic/clac Cimento avec clapet en céramique Universal-Abflussgarnitur Click-Clack Cement mit Keramikstopfen Универсальный донный Cemento click/clack с керамической крышкой</p>		PIL01CM(X)*	0,40	<ul style="list-style-type: none"> <li>Gloss White</li> <li>*X = N - Gloss Black</li> <li>Le Terre di Cielo</li> </ul>	<ul style="list-style-type: none"> <li>120,00</li> <li>159,00</li> <li>169,00</li> </ul>		
 <p><b>Universal click/clack drain in BRONZE with ceramic lid</b> Válvula universal click/clack Bronce con tapa en cerámica Bonde universelle clic/clac Bronze avec clapet en céramique Universal-Abflussgarnitur Click-Clack Bronze mit Keramikstopfen Универсальный донный клапан click/clack бронза с керамической крышкой</p>		PIL01BR(X)*	0,40	<ul style="list-style-type: none"> <li>Gloss White</li> <li>*X = N - Gloss Black</li> <li>Le Terre di Cielo</li> </ul>	<ul style="list-style-type: none"> <li>135,00</li> <li>171,00</li> <li>182,00</li> </ul>		
 <p><b>CHROMED siphon</b> Sifone Cromado \ Siphon Chromé \ Siphon Verchromt \ сифон Chrome</p>		SISP	0,93	<ul style="list-style-type: none"> <li>Chrome</li> </ul>	133,00		
 <p><b>MATT BLACK siphon</b> Sifone Negro Mate \ Siphon Noir Mat \ Siphon Schwarz Matt \ Сифон Черный матовый</p>		SIFN	0,93	<ul style="list-style-type: none"> <li>Matt Black</li> </ul>	194,00		
 <p><b>CEMENTO siphon</b> Sifone Cemento \ Siphon Cemento \ Siphon Cemento \ сифон Cemento</p>		SIFCM	0,93	<ul style="list-style-type: none"> <li>Cemento</li> </ul>	194,00		
 <p><b>BRONZE siphon</b> Sifone Bronce \ Siphon Bronze \ Siphon Bronze \ бронза сифон</p>		SIFBR	0,93	<ul style="list-style-type: none"> <li>Bronze</li> </ul>	220,00		







## Technical symbols legend

Simbolos técnicos clave / Légende symboles techniques / Technische Zeichenerklärung / Перечень технических символов

 all sides are enamelled / con todos los lados esmaltados / avec tous les côtés émaillés / alle Seiten glasiert / все стороны глазурированные  
 no tap holes / sin agujero para grifo / sans orifice robinet / ohne Hahnloch / все стороны покрыты эмалью  
 with overflow / con rebosadero / avec trop-plein / mit Überlauf / с переливом  
 on top installation / instalación de apoyo / installation à partir du plan / Montage auf Platte / установка на столешницу

Le Terre di Cielo TL - Talco PM - Pomice BR - Brina BA - Basalto LV - Lavagna CM - Cemento FN - Fango CA - Cacao  
 AN - Arenaria AV - Avena LN - Lino AG - Agave MU - Muschio PL - Polvere CP - Cipria CN - Canapa



	Size (cm)	Product code	Net weight(Kg)	Finishes	Euro	Pz.	Pz.
	Medidas Dimensions Maße Размеры	Artículo Article Artikel Артикул	Peso neto Poids net Reinewicht вес нетто	Acabados Finitions Farbe Отделка	Евро	шт. pallet Italia	шт. pallet Cont.
 <p><b>Wall-hung wc with fixing kit (4,5 LT)</b>                      Wc suspendido completo con fijaciones (4,5 LT)                      Wc suspendu avec fixation (4,5 LT)                      Wand-WC mit Befestigungskit (4,5 LT)                      Унитаз подвесной в комплекте с крепежами (4,5 LT)</p>	37 x 53 x 37 h	FLVS(X)*	24,50	<ul style="list-style-type: none"> <li><span style="display: inline-block; width: 10px; height: 10px; background-color: white; border: 1px solid black; border-radius: 50%; margin-right: 5px;"></span> Gloss White</li> <li><span style="display: inline-block; width: 10px; height: 10px; background-color: black; border: 1px solid black; border-radius: 50%; margin-right: 5px;"></span> *X = N - Gloss Black</li> <li><span style="display: inline-block; width: 10px; height: 10px; background-color: lightgrey; border: 1px solid black; border-radius: 50%; margin-right: 5px;"></span> *X = TL - Talco</li> <li><span style="display: inline-block; width: 10px; height: 10px; background-color: brown; border: 1px solid black; border-radius: 50%; margin-right: 5px;"></span> Le Terre di Cielo*</li> </ul>	529,00 765,00 844,00 965,00	15	20
 <p><b>Thermosetting seat &amp; cover</b>                      Asiento para inodoro                      Abattant thermodurcissable                      Wc-sitz thermodur                      Сиденье из термоотверждающейся смолы</p>		CPVFLT	2,40	<ul style="list-style-type: none"> <li><span style="display: inline-block; width: 10px; height: 10px; background-color: white; border: 1px solid black; border-radius: 50%; margin-right: 5px;"></span> Gloss White</li> </ul>	110,00		
 <p><b>Thermosetting soft close seat &amp; cover</b>                      Asiento para inodoro amortiguado                      Abattant thermodurcissable soft                      Wc-sitz thermodur mit Abs                      Сиденье из термоотверждающейся смолы, с плавным опусканием</p>		CPVFLTF(X)*	2,40	<ul style="list-style-type: none"> <li><span style="display: inline-block; width: 10px; height: 10px; background-color: white; border: 1px solid black; border-radius: 50%; margin-right: 5px;"></span> Gloss White</li> <li><span style="display: inline-block; width: 10px; height: 10px; background-color: black; border: 1px solid black; border-radius: 50%; margin-right: 5px;"></span> *X = N - Gloss Black</li> <li><span style="display: inline-block; width: 10px; height: 10px; background-color: lightgrey; border: 1px solid black; border-radius: 50%; margin-right: 5px;"></span> *X = TL - Talco</li> <li><span style="display: inline-block; width: 10px; height: 10px; background-color: brown; border: 1px solid black; border-radius: 50%; margin-right: 5px;"></span> Le Terre di Cielo*</li> </ul>	172,00 253,00 296,00 316,00		
 <p><b>Impact and acoustic protection panel</b>                      Protección antigolpes y acústica / Protection                      acoustique et anti-choc / Stoss-und Schalldämmung /                      Противоударная и акустическая защита</p>		PAA	0,16		17,00		
 <p><b>Couple of fixing brackets for wall-hung wc/bidet</b> - Pareja de estribo para Inodoro/Bidet suspendido / Étriers de fixation pour Wc/Bidet suspendus / 1 Paar Halterungen für wandhängendes Wc/Bidet / Монтажная рама для подвесного унитаза/биде</p>	3,3 x 18,5 x 55 h	508	2,00		39,00		

### Technical symbols legend

Símbolos técnicos clave / Légende symboles techniques / Technische Zeichenerklärung / Перечень технических символов

**wall-hung installation**  
 instalación suspendida  
 installation suspendue  
 wandhängende Montage  
 подвесная установка







**with fixing parts**  
 fijaciones incluidas  
 fixations incluses  
 inklusive Befestigungen  
 в комплекте с крепежами

**Combifix compatibility**  
 compatible Combifix  
 mit Combifix kompatibel  
 совместим с combifix

**4,5 l toilet tank**  
 descarga 4,5 l  
 évacuation à 4,5 l  
 4,5 l-Spülung  
 бачок на 4,5 л

\* Terre di Cielo finishes available for wc-bidet / Acabados Terre di Cielo disponibles para wc-bidet / Finitions Terre di Cielo disponibles pour cuvette-bidet / Für das WC/Bidet erhältliche Ausführungen Terre di Cielo / отделка Terre di Cielo доступны для унитаза и биде

TL - Talco   
  PM - Pomice   
  BR - Brina   
  AN - Arenaria  
 AV - Avena   
  CM - Cemento   
  BA - Basalto

	<b>Size (cm)</b> Medidas Dimensions Maße Размеры	<b>Product code</b> Artículo Article Artikel Артикул	<b>Net weight(Kg)</b> Peso neto Poids net Reingewicht вес нетто	<b>Finishes</b> Acabados Finitions Farbe Отделка	<b>Euro</b> Евро	<b>Pz.</b> шт. pallet Italia	<b>Pz.</b> шт. pallet Cont.
<b>Wall-hung one hole bidet with fixing kit</b> Bidé suspendido monoagujero completo con fijaciones Bidet suspendu monotrou avec fixation Wand-Bidet einloch mit Befestigungskit Биде подвесное с одним отверстием под смеситель, в комплекте с крепежами	37 x 53 x 37 h	FLBS(X)*	23,55	● Gloss White ● *X = N - Gloss Black ● *X = TL - Talco ● Le Terre di Cielo*	529,00 765,00 844,00 965,00	15	20
 <b>Impact and acoustic protection panel</b> Protección antigolpes y acústica / Protection acoustique et anti-choc / Stoss- und Schalldämmung / Противоударная и акустическая защита		PAA	0,16		17,00		
 <b>Couple of fixing brackets for wall-hung wc/bidet</b> - Pareja de estribo para Inodoro/ Bidet suspendido / Étriers de fixation pour Wc/Bidet suspendus / 1 Paar Halterungen für wandhängendes Wc/Bidet / Монтажная рама для подвесного унитаза/ биде	3,3 x 18,5 x 55 h	508	2,00		39,00		
 <b>Universal click/clack drain in CHROME with ceramic lid</b> Válvula universal click/clack Cromado con tapa en cerámica Bonde universelle clic/clac Chromé avec clapet en céramique Universal-Ablaufgarnitur Click-Clack Chrom mit Keramikstopfen Универсальный донный клапан click/clack хром с керамической крышкой		PIL01(X)*	0,40	● Gloss White ● *X = N - Gloss Black ● Le Terre di Cielo	95,00 114,00 139,00		
 <b>Universal click/clack drain in BLACK MATT finish with ceramic lid</b> Válvula universal click/clack Negro Matt con tapa en cerámica Bonde universelle clic/clac Noir Mat avec clapet en céramique Universal-Ablaufgarnitur Click-Clack Matt Schwarz mit Keramikstopfen Универсальный донный клапан click/clack черный матовый с керамической крышкой		PIL01NM(X)*	0,40	● Gloss White ● *X = N - Gloss Black ● Le Terre di Cielo	120,00 159,00 169,00		
 <b>Universal click/clack drain in CEMENTO finish with ceramic lid</b> Válvula universal click/clack Cemento con tapa en cerámica Bonde universelle clic/clac Cemento avec clapet en céramique Universal-Ablaufgarnitur Click-Clack Cement mit Keramikstopfen Универсальный донный Cemento click/clack с керамической крышкой		PIL01CM(X)*	0,40	● Gloss White ● *X = N - Gloss Black ● Le Terre di Cielo	120,00 159,00 169,00		
 <b>Universal click/clack drain in BRONZE with ceramic lid</b> Válvula universal click/clack Bronce con tapa en cerámica Bonde universelle clic/clac Bronze avec clapet en céramique Universal-Ablaufgarnitur Click-Clack Bronze mit Keramikstopfen Универсальный донный клапан click/clack бронза с керамической крышкой		PIL01BR(X)*	0,40	● Gloss White ● *X = N - Gloss Black ● Le Terre di Cielo	135,00 171,00 182,00		

### Technical symbols legend

Simbolos técnicos clave / Légende symboles techniques / Technische Zeichenerklärung / Перечень технических символов

 **wall-hung installation**  
 instalación suspendida  
 installation suspendue  
 wandhängende Montage  
 подвесная установка

 **with fixing parts**  
 fijaciones incluidas  
 fixations incluses  
 inklusive Befestigungen  
 в комплекте с крепежами







 **one tap hole**  
 con 1 agujero  
 monotrou  
 1-Loch  
 одно отверстие под смеситель

 **with overflow**  
 con rebosadero  
 avec trop-plein  
 mit Überlauf  
 с переливом

 **Combifix compatibility**  
 compatible Combifix  
 mit Combifix kompatibel  
 совместим с combifix

\* Terre di Cielo finishes available for wc-bidet / Acabados Terre di Cielo disponibles para wc-bidet / Finitions Terre di Cielo disponibles pour cuvette-bidet / Für das WC/Bidet erhältliche Ausführungen Terre di Cielo / Отделка Terre di Cielo доступны для унитаза и биде

● TL - Talco    ● PM - Pomice    ● BR - Brina    ● AN - Arenaria  
 ● AV - Avena    ● CM - Cemento    ● BA - Basalto

		Size (cm)	Product code	Net weight (Kg)	Finishes	Euro	Pz.	Pz.
		Medidas Dimensions Maße Размеры	Artículo Article Artikel Артикул	Peso neto Poids net Reingewicht вес нетто	Acabados Finitions Farbe Отделки	Евро	шт. pallet Italia	шт. pallet Cont.
<b>Wc with horizontal outlet convertible to floor outlet by technical curve (4,5 LT)</b> Wc con desagüe a pared convertible a suelo con curva técnica (4,5 LT) Wc avec évacuation murale transformable à terre avec courbe technique (4,5L) WC mit Wandabfluss, durch Kurventechnik auf Bodenabfluss umrüstbar (4,5 LT) Слив в стену при помощи технического колена трансформируется на слив в пол (4,5 л)		37 x 53 x 41,5 h	FLVA(X)*	31,35	● Gloss White ● *X = N - Gloss Black ● *X = TL - Talco ● Le Terre di Cielo*	492,00 741,00 828,00 940,00	15	20
 <b>Thermosetting seat &amp; cover</b> Asiento para inodoro Abattant thermodurcissable Wc-sitz thermotur Сиденье из термоотверждающейся смолы			CPVFLT	2,40	● Gloss White	110,00		
 <b>Thermosetting soft close seat &amp; cover</b> Asiento para inodoro amortiguado Abattant thermodurcissable soft Wc-sitz thermotur mit Abs Сиденье из термоотверждающейся смолы, с плавным опусканием			CPVFLTF(X)*	2,40	● Gloss White ● *X = N - Gloss Black ● *X = TL - Talco ● Le Terre di Cielo*	172,00 253,00 296,00 316,00		
 <b>Technical curve "floor trap" for toilet</b> Curva técnica "salida vertical" para inodoro / Courbe technique à S pour cuvette avec sortie au sol / WC-Ablaufbogen "S" / Колено "S"-образное для унитазов, регулируемое			CSB	0,40		18,00		
 <b>Straight pan connector for wall trap</b> Anclaje a pared para inodoro Pipe pour sortie horizontale WC-Anschlussstutzen für Abgang waagerecht Фитинг для выпуска в стену для унитазов			RPB	0,35		15,00		

### Technical symbols legend

Simbolos técnicos clave | Légende symboles techniques | Technische Zeichenerklärung | Перечень технических символов

 <b>back to wall installation</b> instalación a suelo installation à terre bodenstehende Montage напольная установка	 <b>with fixing parts</b> fijaciones incluidas fixations incluses inklusive Befestigungen в комплекте с крепежами	 <b>4,5 l toilet tank</b> descarga 4,5 lt évacuation à 4,5 l 4,5 l-Spülung бачок на 4,5 л	 <b>bifunctional drain</b> descarga bifuncional évacuation bifonctionnelle Spülung mit zwei Montagevarianten функциональный бачок
--	--	--	---





\* Terre di Cielo finishes available for wc-bidet | Acabados Terre di Cielo disponibles para wc-bidet | Finitions Terre di Cielo disponibles pour cuvette-bidet | Für das WC/Bidet erhältliche Ausführungen Terre di Cielo | отделки Terre di Cielo доступны для унитаза и биде

● TL - Talco	● PM - Pomice	● BR - Brina	● AN - Arenaria
● AV - Avena	● CM - Cemento	● BA - Basalto	







## Back to wall one hole bidet

Bidé a suelo monoagujero  
Bidet monotrou  
Stand-Bidet einloch  
Биде напольное с одним отверстием под смеситель

	Size (cm) Medidas Dimensions Maße Размеры	Product code Artículo Article Artikel Артикул	Net weight(Kg) Peso neto Poïds net Reingewicht вес нетто	Finishes Acabados Finitions Farbe Отделка	Euro Евро	Pz. шт. pallet Italia	Pz. шт. pallet Cont.
	37 x 53 x 41,5 h	FLBI(X)*	25,85	<ul style="list-style-type: none"> <li><span style="display: inline-block; width: 10px; height: 10px; border: 1px solid black; border-radius: 50%; background-color: white; margin-right: 5px;"></span> Gloss White</li> <li><span style="display: inline-block; width: 10px; height: 10px; border: 1px solid black; border-radius: 50%; background-color: black; margin-right: 5px;"></span> *X = N - Gloss Black</li> <li><span style="display: inline-block; width: 10px; height: 10px; border: 1px solid black; border-radius: 50%; background-color: #cccccc; margin-right: 5px;"></span> *X = TL - Talco</li> <li><span style="display: inline-block; width: 10px; height: 10px; border: 1px solid black; border-radius: 50%; background-color: #808080; margin-right: 5px;"></span> Le Terre di Cielo*</li> </ul>	492,00 741,00 828,00 940,00	15	20
 <b>Universal click/clack drain in CHROME with ceramic lid</b> Válvula universal click/clack Cromado con tapa en cerámica Bonde universelle clic/clac Chromé avec clapet en céramique Universal-Abflussgarnitur Click-Clack Chrom mit Keramikstopfen Универсальный донный клапан click/clack хром с керамической крышкой		PIL01(X)*	0,40	<ul style="list-style-type: none"> <li><span style="display: inline-block; width: 10px; height: 10px; border: 1px solid black; border-radius: 50%; background-color: white; margin-right: 5px;"></span> Gloss White</li> <li><span style="display: inline-block; width: 10px; height: 10px; border: 1px solid black; border-radius: 50%; background-color: black; margin-right: 5px;"></span> *X = N - Gloss Black</li> <li><span style="display: inline-block; width: 10px; height: 10px; border: 1px solid black; border-radius: 50%; background-color: #808080; margin-right: 5px;"></span> Le Terre di Cielo</li> </ul>	95,00 114,00 139,00		
 <b>Universal click/clack drain in BLACK MATT finish with ceramic lid</b> Válvula universal click/clack Negro Matt con tapa en cerámica Bonde universelle clic/clac Noir Mat avec clapet en céramique Universal-Abflussgarnitur Click-Clack Matt Schwarz mit Keramikstopfen Универсальный донный клапан click/clack черный матовый с керамической крышкой		PIL01NM(X)*	0,40	<ul style="list-style-type: none"> <li><span style="display: inline-block; width: 10px; height: 10px; border: 1px solid black; border-radius: 50%; background-color: white; margin-right: 5px;"></span> Gloss White</li> <li><span style="display: inline-block; width: 10px; height: 10px; border: 1px solid black; border-radius: 50%; background-color: black; margin-right: 5px;"></span> *X = N - Gloss Black</li> <li><span style="display: inline-block; width: 10px; height: 10px; border: 1px solid black; border-radius: 50%; background-color: #808080; margin-right: 5px;"></span> Le Terre di Cielo</li> </ul>	120,00 159,00 169,00		
 <b>Universal click/clack drain in CEMENTO finish with ceramic lid</b> Válvula universal click/clack Cemento con tapa en cerámica Bonde universelle clic/clac Cemento avec clapet en céramique Universal-Abflussgarnitur Click-Clack Cement mit Keramikstopfen Универсальный донный Cemento click/clack с керамической крышкой		PIL01CM(X)*	0,40	<ul style="list-style-type: none"> <li><span style="display: inline-block; width: 10px; height: 10px; border: 1px solid black; border-radius: 50%; background-color: white; margin-right: 5px;"></span> Gloss White</li> <li><span style="display: inline-block; width: 10px; height: 10px; border: 1px solid black; border-radius: 50%; background-color: black; margin-right: 5px;"></span> *X = N - Gloss Black</li> <li><span style="display: inline-block; width: 10px; height: 10px; border: 1px solid black; border-radius: 50%; background-color: #808080; margin-right: 5px;"></span> Le Terre di Cielo</li> </ul>	120,00 159,00 169,00		
 <b>Universal click/clack drain in BRONZE with ceramic lid</b> Válvula universal click/clack Bronce con tapa en cerámica Bonde universelle clic/clac Bronze avec clapet en céramique Universal-Abflussgarnitur Click-Clack Bronze mit Keramikstopfen Универсальный донный клапан click/clack бронза с керамической крышкой		PIL01BR(X)*	0,40	<ul style="list-style-type: none"> <li><span style="display: inline-block; width: 10px; height: 10px; border: 1px solid black; border-radius: 50%; background-color: white; margin-right: 5px;"></span> Gloss White</li> <li><span style="display: inline-block; width: 10px; height: 10px; border: 1px solid black; border-radius: 50%; background-color: black; margin-right: 5px;"></span> *X = N - Gloss Black</li> <li><span style="display: inline-block; width: 10px; height: 10px; border: 1px solid black; border-radius: 50%; background-color: #808080; margin-right: 5px;"></span> Le Terre di Cielo</li> </ul>	135,00 171,00 182,00		

### Technical symbols legend

Simbolos técnicos clave | Légende symboles techniques | Technische Zeichenerklärung | Перечень технических символов

 <p><b>one tap hole</b> con 1 agujero monotrou 1-Loch одно отверстие под смеситель</p>	 <p><b>with overflow</b> con rebosadero avec trop-plein mit Überlauf с переливом</p>	 <p><b>back to wall installation</b> instalación a suelo installation à terre bodenstehende Montage напольная установка</p>	 <p><b>with fixing parts</b> fijaciones incluidas fixations incluses inklusive Befestigungen в комплекте с крепежами</p>
--	---	--	---

\* Terre di Cielo finishes available for wc-bidet / Acabados Terre di Cielo disponibles para wc-bidet / Finitions Terre di Cielo disponibles pour cuvette-bidet / Für das WC/Bidet erhältliche Ausführungen Terre di Cielo / отделка Terre di Cielo доступны для унитаза и биде

<span style="display: inline-block; width: 10px; height: 10px; border: 1px solid black; border-radius: 50%; background-color: #cccccc; margin-right: 5px;"></span> TL - Talco	<span style="display: inline-block; width: 10px; height: 10px; border: 1px solid black; border-radius: 50%; background-color: #d3d3d3; margin-right: 5px;"></span> PM - Pomice	<span style="display: inline-block; width: 10px; height: 10px; border: 1px solid black; border-radius: 50%; background-color: #808080; margin-right: 5px;"></span> BR - Brina	<span style="display: inline-block; width: 10px; height: 10px; border: 1px solid black; border-radius: 50%; background-color: #654321; margin-right: 5px;"></span> AN - Arenaria
<span style="display: inline-block; width: 10px; height: 10px; border: 1px solid black; border-radius: 50%; background-color: #808080; margin-right: 5px;"></span> AV - Avena	<span style="display: inline-block; width: 10px; height: 10px; border: 1px solid black; border-radius: 50%; background-color: #404040; margin-right: 5px;"></span> CM - Cemento	<span style="display: inline-block; width: 10px; height: 10px; border: 1px solid black; border-radius: 50%; background-color: #404040; margin-right: 5px;"></span> BA - Basalto	



**Monoblock wc with horizontal outlet convertible to floor outlet by technical curve (4,5 LT) / Wc monobloque con desagüe a pared convertible a suelo con curva técnica (4,5 LT) / Ensemble WC avec évacuation murale transformable à terre avec courbe technique (4,5 LT) / Stand-Klosett WC mit Wandabfluss, durch Kurventechnik auf Bodenabfluss umrüstbar (4,5 LT) / Унитаз моноблочный Слив в стену при помощи технического колена трансформируется на слив в пол (4,5 LT)**

+

**Cistern for monoblock wc**

Tanque bajo para inodoro / Reservoir Mbl  
Spülkasten / Бачок с установкой на унитаз для моноблочного унитаза

Size (cm) Medidas Dimensions Maße Размеры	Product code Artículo Article Artikel Артикул	Net weight (Kg) Peso neto Poids net Reingewicht вес нетто	Finishes Acabados Finitions Farbe Отделки	Euro Евро	Pz. шт. pallet Italia	Pz. шт. pallet Cont.
37 x 68 x 41,5 h	FLVM(X)*	33,95	Gloss White	576,00	9+9	12+12
37 x 41 x 14 h	FLCM(X)*	12,40	Gloss White	189,00		
	CPVFLT	2,40	Gloss White	110,00		
	CPVFLT(X)*	2,40	Gloss White	172,00		
	SMMEC	2,45	Chrome	152,00		
	CSB	0,40		18,00		
	RPB	0,35		15,00		
	CSR90	0,75		19,00		

**Technical symbols legend**

Simbolos técnicos clave / Légende symboles techniques / Technische Zeichenerklärung / Перечень технических символов

**back to wall installation**  
instalación a suelo  
installation à terre  
bodenstehende Montage  
напольная установка

**with fixing parts**  
fijaciones incluidas  
fixations incluses  
inklusive Befestigungen  
в комплекте с крепежами

**4,5 l toilet tank**  
descarga 4,5 lt  
évacuation à 4,5 l  
4,5 l-Spülung  
бачок на 4,5 л

**bifunctional drain**  
descarga bifuncional  
évacuation bifonctionnelle  
Spülung mit zwei  
Montagevarianten  
функциональный бачок

\* Terre di Cielo finishes available for wc-bidet / Acabados Terre di Cielo disponibles para wc-bidet / Finitions Terre di Cielo disponibles pour cuvette-bidet / Für das WC/Bidet erhältliche Ausführungen Terre di Cielo / оттенки Terre di Cielo доступны для унитаза и биде

- TL - Talco
- PM - Pomice
- BR - Brina
- AN - Arenaria
- AV - Avena
- CM - Cemento
- BA - Basalto









# The Shower World

INFINITO h3 - ceramic  
pg. 513 - 523

SESSANTA h6 - ceramic  
pg. 525 - 529

VENTICINQUE h2,5 - marmogres  
pg. 531 - 537

AUGUSTO - ceramic  
pg. 539 - 541



### Infinito H3

piatto doccia in ceramica h3  
h3 ceramic shower tray  
pg. 513

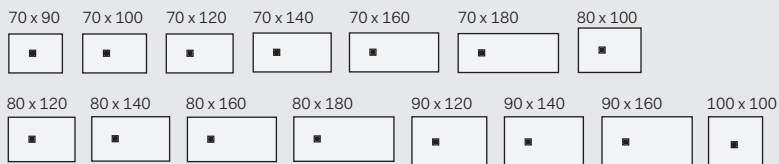

### Sessanta H6

piatto doccia in ceramica h6  
h6 ceramic shower tray  
pg. 525

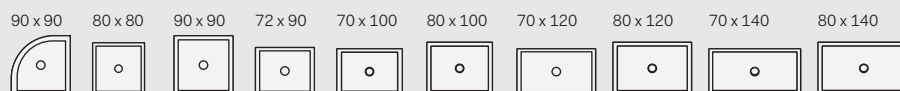

### Venticinque H2,5

piatto doccia in marmogres h2,5  
h2,5 ceramic shower tray  
pg. 531

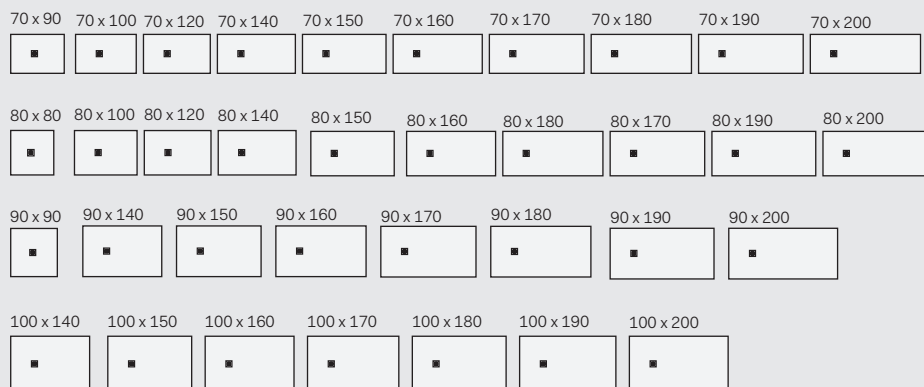

### I Catini - Augusto

piatto doccia Augusto in ceramica  
Augusto ceramic shower tray  
cm 106 x 106 x 20 h  
pg. 539

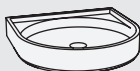

## Finishes\_Acabados\_Finitions\_Farbe\_Отделки

- Gloss White
- TW - Total White Antiscivolo - Non slip \*

### Le Terre di Cielo

- TL - Talco
- PM - Pomice
- BR - Brina
- CM - Cemento
- BA - Basalto
- LV - Lavagna
- CA - Cacao
- AN - Arenaria
- AV - Avena
- MU - Muschio
- LN - Lino
- PL - Polvere

**\* Note: Slip-resistant finish of Total White can only be possible on White Gloss finish. Add an additional 50% on the price White Gloss finish. 7) Please note, with the anti-slip, the shower tray has an unfinished side that needs to be installed against the wall, so please specify this when ordering.**

*P.S. El acabado antideslizante Total White sólo se realizan en blanco brillante. En el precio, hay un aumento del 50%. Atención, con el antideslizante el plato de ducha tendrá una cara sin rematar que irá necesariamente a pared, así que al hacer el pedido por favor especifíquelo. / N.B. La finition antidérapante Total White peuvent être réalisées uniquement sur le Blanc Brillant. Pour le prix il faut compter un supplément de l'ordre de 50% calculé sur le tarif du Blanc Brillant. Veuillez noter qu'avec l'antidérapant, le receveur de douche aura un côté non fini qui sera nécessairement contre le mur. Veuillez donc spécifier le côté en question lors de la commande. / Hinweis: Die rutschhemmenden Ausführungen Total White sind nur auf Weiß glänzend erhältlich. Der Aufpreis beträgt in diesem Fall 50 % auf den Preis von Weiß glänzend. Achtung: in der rutschhemmenden Ausführung hat die Duschwanne eine unbearbeitete Seite, die immer zur Wand hin ausgerichtet werden muss. Bitte geben Sie dies im Moment der Bestellung an. Bitte geben Sie dies im Moment der Bestellung unbedingt an. / N.B. Противоскользящая обработка Total White возможна только для Bianco Lucido. К цене добавляется 50% от цены Bianco Lucido. Внимание, у душевых поддонов (с антискользящей поверхностью) один край будет без обработки и поэтому необходимо обязательно пометить при заказе какой из краев должен примыкать к стене.*

**The possible variations of the colour cannot be considered as defect, but as a guarantee of the completely artisan manufacturing of this unique and high quality product.**

*Las variaciones de colores no se consideran un defecto sino una garantía de una elaboración manual y artesanal en un producto único y de calidad.*

*Les éventuelles variations de couleur ne peuvent être considérées comme des défauts, elles témoignent en revanche d'une méthode de travail totalement manuelle et artisanale employée pour obtenir un produit fini unique et de qualité.*

*Eventuelle Farbvariationen sind nicht als Mangel anzusehen, sondern als Garantie für die komplett handwerkliche Anfertigung eines einzigartigen und hochqualitativen Produkts.*

*Возможные вариации цвета не могут считаться дефектом, а являются подтверждением ручной работы, гарантией качества и уникальности изделия.*

## Shower Trays\_Bac a douche\_ Duschwanne\_ Душевой поддон



**PD37090**  
70 x 90 x 3 h  
pag. 518



**PD370100**  
70 x 100 x 3 h  
pag. 518



**PD370120**  
70 x 120 x 3 h  
pag. 518



**PD370140**  
70 x 140 x 3 h  
pag. 518



**PD370160**  
70 x 160 x 3 h  
pag. 519

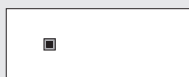

**PD370180**  
70 x 180 x 3 h  
pag. 519



**PD380100**  
80 x 100 x 3 h  
pag. 520



**PD380120**  
80 x 120 x 3 h  
pag. 520



**PD380140**  
80 x 140 x 3 h  
pag. 520



**PD380160**  
80 x 160 x 3 h  
pag. 521



**PD380180**  
80 x 180 x 3 h  
pag. 521



**PD390120**  
90 x 120 x 3 h  
pag. 522



**PD390140**  
90 x 140 x 3 h  
pag. 522



**PD390160**  
90 x 160 x 3 h  
pag. 522

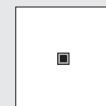

**PD3100100**  
100 x 100 x 3 h  
pag. 523

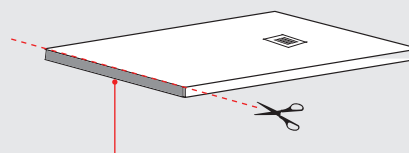

### **N.B.: The custom sizes have unglazed sides.**

*P.D.: Los tamaños personalizados tienen el lado del corte sin esmaltar.*

*NB: les formats sur mesure ont les arrêtes qui ne sont pas émaillés.*

*Hinweis: Bei maßgefertigten Formaten ist die zugeschnittene Seite nicht glasiert.*

*N.B.: У изделий с подрезкой под размер клиента обрезанный торец не будет покрыт эмалью.*



## Custom cuts

**N.B.** Made-to-measure shower trays will be charged an additional fee of €25 per piece (net price + VAT) with reference to the size immediately above the one requested.

**N.B.** Para los platos de ducha con cortes a medida se cobrará un coste adicional de 25 € por pieza (precio neto + IVA) en referencia a la medida inmediatamente superior a la solicitada.

**N.B.** Les receveurs de douche réalisés sur mesure feront l'objet d'une majoration de l'ordre de 25 € par pièce (prix net + TVA) en référence à la taille immédiatement supérieure à celle demandée.

**N.B.** Для душевых поддонов с нестандартными размерами и для всех подрезок под размер применяется наценка в размере 25 евро за штуку (цена нетто + НДС), для расчета берется стандартный размер, наиболее близкий к запрашиваемому в сторону увеличения.

**DX**

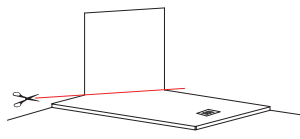
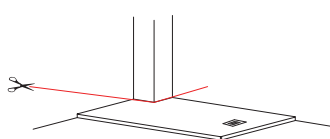

**SX**

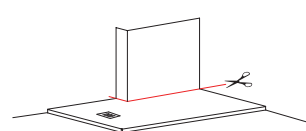
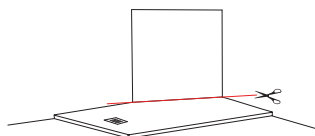
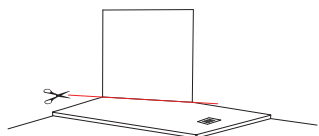
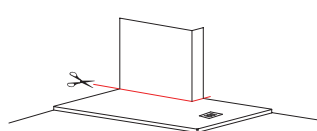
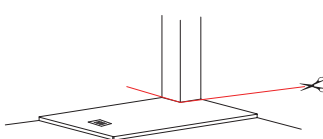
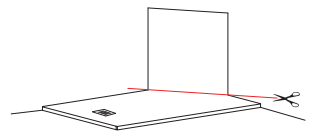

**DX**

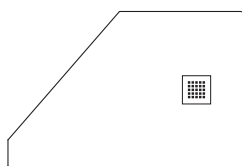
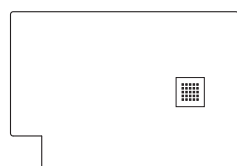

**SX**

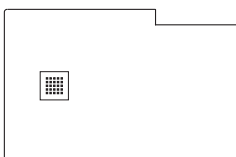
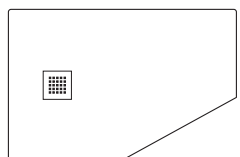
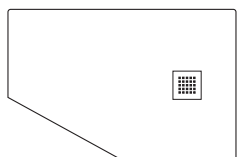
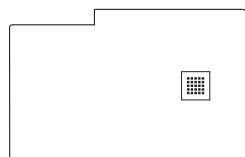
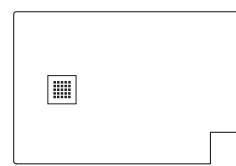
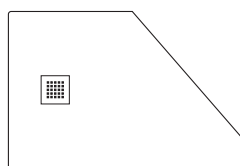

## Custom Cut Request form

All of the Infinito collection's shower trays may be custom cut. / Todos los platos de ducha de la colección Infinito se pueden cortar a medida. / Tous les receveurs de douche de la collection Infinito peuvent être découpés sur mesure. / Alle Duschwannen der Kollektion Infinito sind nach Maß zuschneidbar. / Все душевые поддоны из коллекции Infinito могут быть вырезаны под размер

 = 5 cm (Every square corresponds to a module of 5 cm)  
 = 5 cm (chaque carré correspond à un module de 5 cm)  
 = 5 cm (cada cuadro corresponde a un módulo de 5 cm)  
 = 5 cm (jedes Quadrat entspricht einem Modul von 5 cm)  
 = 5 cm (каждый квадратик соответствует одному модулю на 5 см)

\*Mark in the provided boxes the final size of the shower tray and draw the cut lines on the diagram. / \*Indicar en los rectángulos especiales la medida final del plato de ducha y dibujar las líneas de corte. / \*Indiquer dans l'encadré prévu à cet effet la dimension finale du receveur et dessiner sur le schéma les lignes de découpe. \*Bitte geben Sie in den entsprechenden Rechtecken das Endmaß der Duschwanne an, und zeichnen Sie im Schema die Schnittlinien ein. / \*В соответствующих ячейках укажите окончательный размер душевого поддона и нарисуйте на схеме линии вырезов.

All requests must be specifically evaluated and approved by our technical department.

Todos los pedidos deben ser evaluados y aprobados por nuestro Departamento Técnico.

Toutes les demandes devront être évaluées au cas par cas et approuvées par notre Service Technique.

Alle Anfragen müssen einer gesonderten Prüfung und Genehmigung durch unser Technisches Büro unterzogen werden. Toutes les demandes devront être évaluées au cas par cas et approuvées par notre Service Technique.

Все запросы должны быть проанализированы и подтверждены нашим Техническим Отделом.

## Note:



Cuts cannot be performed in the zone highlighted in grey (about 70 x 70 cm).

No es posible hacer cortes en el área resaltada en color gris (alrededor de 70 x 70 cm). / Il n'est pas possible d'effectuer de découpe dans la zone surlignée en gris (environ 70 x 70 cm). / Im grau gekennzeichneten Bereich können keine Schnitte ausgeführt werden (ca. 70 x 70 cm)

Невозможно выполнить вырезы в зоне, обозначенной серым цветом (около 70 x 70 см).



The minimum measurements of the cut is 1 cm. Beyond this measure you may perform cuts of 0.5 in 0.5 centimetres.

La medida mínima del corte es de 1 cm. Además de esa medida se pueden realizar cortes de 0,5 en 0,5 centímetros.

La mesure minimum de découpe est de 1 cm. Au-delà de cette mesure on peut effectuer des découpes de 5 millimètres en 5 millimètres.

Das Mindestmaß für Schnitte ist 1 cm. Über dieses Maß hinaus können Schnitte im Abstand von jeweils 0,5 Zentimetern ausgeführt werden.

- Минимальный размер выреза 1 см. Кроме этого размера можно выполнять вырезы 0,5 на 0,5 см.



The cut side will not be glazed, so must be flush against the wall or recessed in the floor, in any case must be well sealed.

El lado cortado permanece sin esmaltar, se debe colocar contra la pared o empotrado en el suelo, o bien sellado.

Le côté découpé restera non émaillé et devra être accolé à la paroi ou encastré au sol et bien isolé.

Die zugeschnittene Seite ist nicht glasiert und muss an der Wand positioniert oder in den Boden eingelassen und gut versiegelt werden.

Сторона, которая была подвержена резке, остается без эмали, и должна быть установлена к стене либо встроена в пол и хорошо заизолирована.



Curved cuts are not possible.



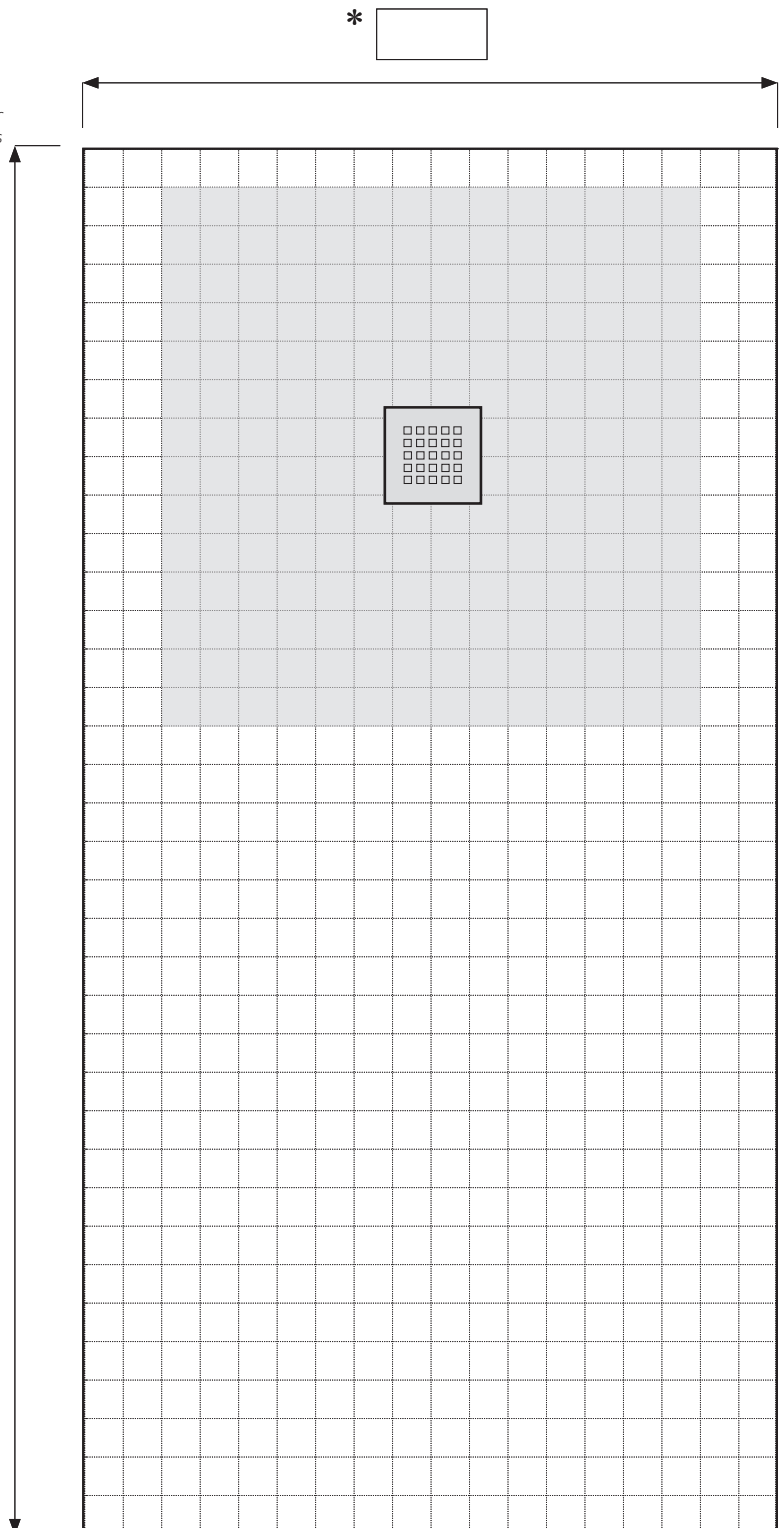

No se pueden efectuar cortes curvos. / Il n'est pas possible d'effectuer de découpes.

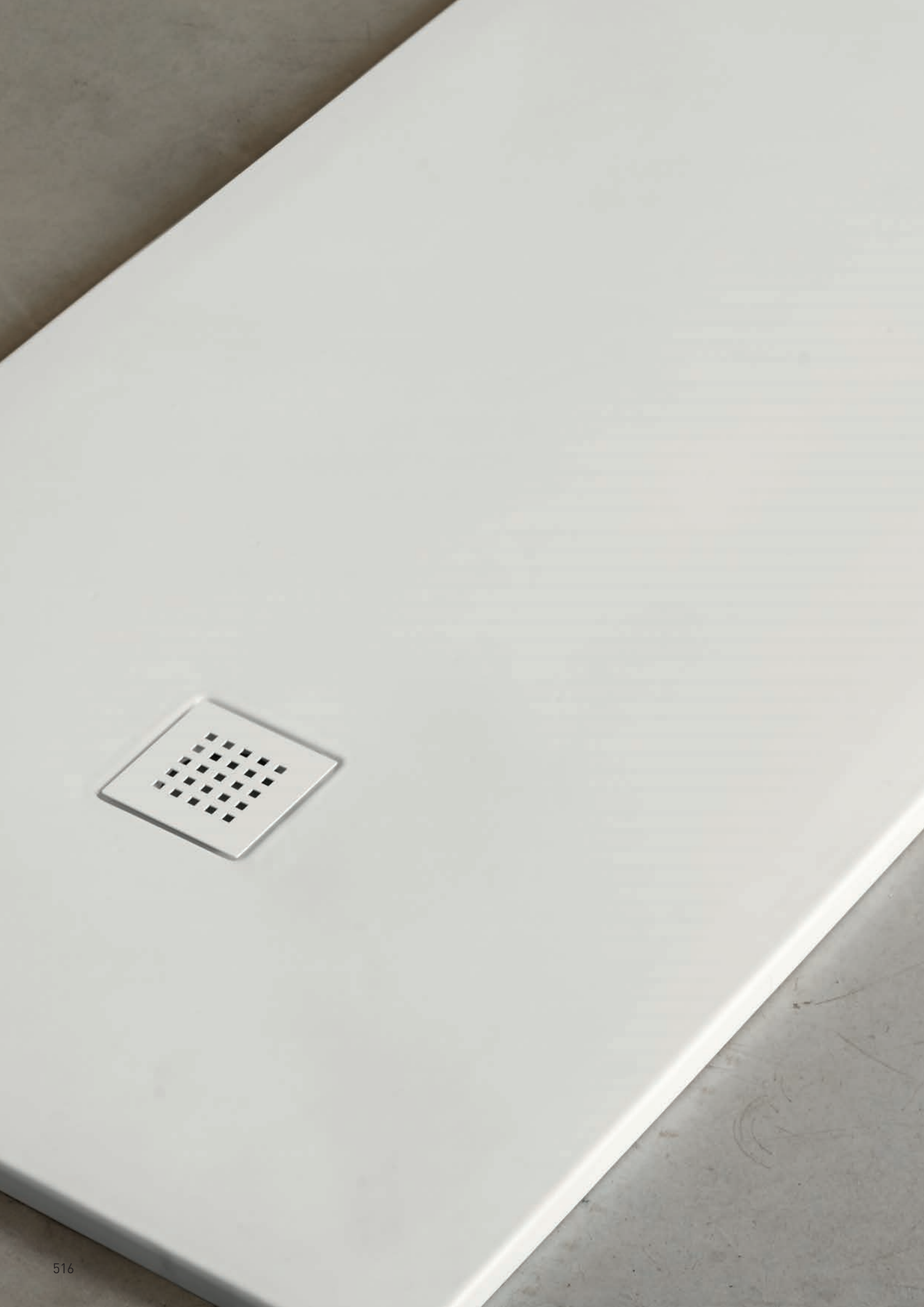
Es können keine gebogenen Schnitte ausgeführt werden. / Выполнение закругленных вырезов невозможно.







	Size (cm)	Product code	Net weight(Kg)	Finishes	Euro	Pz.	Pz.
	Medidas Dimensions Maße Размеры	Artículo Article Artikel Артикул	Peso neto Poids net Reingewicht вес нетто	Acabados Finitions Farbe Отделки	Евро	шт. pallet Italia	шт. pallet Cont.
 <p><b>Rectangular shower tray</b> Plato de ducha rectangular Receveur de douche rectangulaire rechteckige Duschplatte Душевой поддон прямоугольный</p>	<b>70 x 90 x 3 h</b>	PD37090(X)*	22,38	<ul style="list-style-type: none"> <li><span style="display: inline-block; width: 10px; height: 10px; background-color: white; border: 1px solid black; border-radius: 50%; margin-right: 5px;"></span> Gloss White</li> <li><span style="display: inline-block; width: 10px; height: 10px; background-color: #808080; border: 1px solid black; border-radius: 50%; margin-right: 5px;"></span> Le Terre di Cielo*</li> </ul>	<p>605,00</p> <p>721,00</p>		
 <p><b>Rectangular shower tray</b> Plato de ducha rectangular Receveur de douche rectangulaire rechteckige Duschplatte Душевой поддон прямоугольный</p>	<b>70 x 100 x 3 h</b>	PD370100(X)*	25,18	<ul style="list-style-type: none"> <li><span style="display: inline-block; width: 10px; height: 10px; background-color: white; border: 1px solid black; border-radius: 50%; margin-right: 5px;"></span> Gloss White</li> <li><span style="display: inline-block; width: 10px; height: 10px; background-color: #808080; border: 1px solid black; border-radius: 50%; margin-right: 5px;"></span> Le Terre di Cielo*</li> </ul>	<p>645,00</p> <p>745,00</p>		
 <p><b>Rectangular shower tray</b> Plato de ducha rectangular Receveur de douche rectangulaire rechteckige Duschplatte Душевой поддон прямоугольный</p>	<b>70 x 120 x 3 h</b>	PD370120(X)*	31,50	<ul style="list-style-type: none"> <li><span style="display: inline-block; width: 10px; height: 10px; background-color: white; border: 1px solid black; border-radius: 50%; margin-right: 5px;"></span> Gloss White</li> <li><span style="display: inline-block; width: 10px; height: 10px; background-color: #808080; border: 1px solid black; border-radius: 50%; margin-right: 5px;"></span> Le Terre di Cielo*</li> </ul>	<p>723,00</p> <p>889,00</p>		
 <p><b>Rectangular shower tray</b> Plato de ducha rectangular Receveur de douche rectangulaire rechteckige Duschplatte Душевой поддон прямоугольный</p>	<b>70 x 140 x 3 h</b>	PD370140(X)*	36,70	<ul style="list-style-type: none"> <li><span style="display: inline-block; width: 10px; height: 10px; background-color: white; border: 1px solid black; border-radius: 50%; margin-right: 5px;"></span> Gloss White</li> <li><span style="display: inline-block; width: 10px; height: 10px; background-color: #808080; border: 1px solid black; border-radius: 50%; margin-right: 5px;"></span> Le Terre di Cielo*</li> </ul>	<p>913,00</p> <p>1170,00</p>		

### Technical symbols legend

Simbolos técnicos clave | Légende symboles techniques | Technische Zeichenerklärung | Перечень технических символов

**all sides are enamelled**  
con todos los lados esmaltados  
avec tous les côtés émaillés  
alle Seiten glasiert  
все стороны покрыты эмалью





**floor installation**  
instalación de apoyo  
installation à poser  
Aufsatzmontage  
накладная установка

**recessed installation**  
instalación a ras de suelo  
installation à l'italienne au ras  
du sol  
bodenbündige Montage  
установка на пол

\* Terre di Cielo finishes available for shower tray | Acabados Terre di Cielo disponibles para Plato de ducha | Finitions Terre di Cielo disponibles pour Receveur de douche | Für das WC/Duschplatte erhältliche Ausführungen Terre di Cielo | отделки Terre di Cielo доступны для Душевой поддон

TL - Talco
  PM - Pomice
  BR - Brina
  AN - Arenaria
  LV - Lavagna
  CA - Cacao

LN - Lino
  BA - Basalto
  AV - Avena
  CM - Cemento
  MU - Muschio
  PL - Polvere

	Size (cm)	Product code	Net weight (Kg)	Finishes	Euro	Pz.	Pz.
	Medidas Dimensions Maße Размеры	Artículo Article Artikel Артикул	Peso neto Poids net Reingewicht вес нетто	Acabados Finitions Farbe Отделки	Евро	шт. pallet Italia	шт. pallet Cont.
 <p><b>Rectangular shower tray</b> Plato de ducha rectangular Receveur de douche rectangulaire rechteckige Duschplatte Душевой поддон прямоугольный</p>	<b>70 x 160 x 3 h</b>	PD370160(X)*	44,30	<ul style="list-style-type: none"> <li>Gloss White</li> <li>Le Terre di Cielo*</li> </ul>	<ul style="list-style-type: none"> <li>1063,00</li> <li>1363,00</li> </ul>		
 <p><b>Rectangular shower tray</b> Plato de ducha rectangular Receveur de douche rectangulaire rechteckige Duschplatte Душевой поддон прямоугольный</p>	<b>70 x 180 x 3 h</b>	PD370180(X)*	43,50	<ul style="list-style-type: none"> <li>Gloss White</li> <li>Le Terre di Cielo*</li> </ul>	<ul style="list-style-type: none"> <li>1391,00</li> <li>1612,00</li> </ul>		
 <p><b>Siphon drain for shower tray Infinito H3 (obligatory)</b> Desagüe para plato de ducha Infinito H3 (obligatorio) Bonde avec siphon pour receveur de douche Infinito H3 (nécessaire) Ablaufgarnitur mit Siphon für Duschwanne Infinito H3 (geböten) Донный клапан с сифоном для душевого поддона Infinito H3 (обязателен)</p>		SIFPD	0,20		36,00		
 <p><b>Siphon with vertical drain for shower tray Infinito H3 (optional)</b> Desagüe para plato de ducha Infinito H3 (opcional) Bonde avec siphon avec sortie vertical pour receveur de douche Infinito H3 (sur demande) Ablaufgarnitur mit Siphon mit vertikalem Ablauf für Duschwanne Infinito H3 (wahlweise) Донный клапан с сифоном с вертикальным сливом для душевого поддона Infinito H3 (по желанию)</p>		SIFPDV	0,20		36,00		
 <p><b>Stainless steel grate for shower tray Infinito H3 (obligatory)</b> Rejilla en acero inox para plato de ducha Infinito H3 (obligatorio) Grille en acier inox pour receveur de douche Infinito H3 (nécessaire) Gitter aus Edelstahl für Duschwanne Infinito H3 (obligatorisch) Решетка из нержавеющей стали для душевого поддона Infinito H3 (обязательна)</p>		GRPD3	0,20	<ul style="list-style-type: none"> <li>Polished steel Acero pulido Acier poli brillant polierter Stahl Полпированная сталь</li> <li>Le Terre di Cielo*</li> </ul>	<ul style="list-style-type: none"> <li>45,00</li> <li>59,00</li> </ul>		

### Technical symbols legend

Simbolos técnicos clave / Légende symboles techniques / Technische Zeichenerklärung / Перечень технических символов

**all sides are enamelled**  
con todos los lados esmaltados  
avec tous les côtés émaillés  
alle Seiten glasiert  
все стороны покрыты эмалью













**floor installation**  
instalación de apoyo  
installation à poser  
Aufsatzmontage  
накладная установка

**recessed installation**  
instalación a ras de suelo  
installation à l'italienne au ras  
du sol  
bodenbündige Montage  
установка на пол

\* Terre di Cielo finishes available for shower tray / Acabados Terre di Cielo disponibles para Plato de ducha / Finitions Terre di Cielo disponibles pour Receveur de douche / Für das WC/Duschplatte erhältliche Ausführungen Terre di Cielo / отделки Terre di Cielo доступны для Душевой поддон

- TL - Talco
- PM - Pomice
- BR - Brina
- AN - Arenaria
- LV - Lavagna
- CA - Cacao
- LN - Lino
- BA - Basalto
- AV - Avena
- CM - Cemento
- MU - Muschio
- PL - Polvere



	Size (cm)	Product code	Net weight (Kg)	Finishes	Euro	Pz.	Pz.
	Medidas Dimensions Maße Размеры	Artículo Article Artikel Артикул	Peso neto Poids net Reingewicht вес нетто	Acabados Finitions Farbe Отделки	Евро	шт. pallet Italia	шт. pallet Cont.
  <p><b>Rectangular shower tray</b> Plato de ducha rectangular Receveur de douche rectangulaire rechteckige Duschplatte Душевой поддон прямоугольный</p>	80 x 100 x 3 h	PD380100(X)*	29,68	 <b>Gloss White</b>  <b>Le Terre di Cielo*</b>	664,00 839,00		
  <p><b>Rectangular shower tray</b> Plato de ducha rectangular Receveur de douche rectangulaire rechteckige Duschplatte Душевой поддон прямоугольный</p>	80 x 120 x 3 h	PD380120(X)*	38,23	 <b>Gloss White</b>  <b>Le Terre di Cielo*</b>	747,00 994,00		
  <p><b>Rectangular shower tray</b> Plato de ducha rectangular Receveur de douche rectangulaire rechteckige Duschplatte Душевой поддон прямоугольный</p>	80 x 140 x 3 h	PD380140(X)*	44,70	 <b>Gloss White</b>  <b>Le Terre di Cielo*</b>	944,00 1207,00		

### Technical symbols legend











Simbolos técnicos clave | Légende symboles techniques | Technische Zeichenerklärung | Перечень технических символов

**all sides are enamelled**  
con todos los lados esmaltados  
avec tous les côtés émaillés  
alle Seiten glasiert  
все стороны покрыты эмалью

**floor installation**  
instalación de apoyo  
installation à poser  
Aufsatzmontage  
накладная установка

**recessed installation**  
instalación a ras de suelo  
installation à l'italienne au ras  
du sol  
bodenbüändige Montage  
установка на пол

\* Terre di Cielo finishes available for shower tray | Acabados Terre di Cielo disponibles para Plato de ducha | Finitions Terre di Cielo disponibles pour Receveur de douche | Für das WC/Duschplatte erhältliche Ausführungen Terre di Cielo | Отделки Terre di Cielo доступны для Душевой поддон

	Size (cm)	Product code	Net weight (Kg)	Finishes	Euro	Pz.	Pz.
	Medidas Dimensions Maße Размеры	Artículo Article Artikel Артикул	Peso neto Poids net Reingewicht вес нетто	Acabados Finitions Farbe Отделки	Евро	шт. pallet Italia	шт. pallet Cont.
 <p><b>Rectangular shower tray</b> Plato de ducha rectangular Receveur de douche rectangulaire rechteckige Duschplatte Душевой поддон прямоугольный</p>	80 x 160 x 3 h	PD380160(X)*	47,18	 <b>Gloss White</b>  <b>Le Terre di Cielo*</b>	1296,00 1611,00		
 <p><b>Rectangular shower tray</b> Plato de ducha rectangular Receveur de douche rectangulaire rechteckige Duschplatte Душевой поддон прямоугольный</p>	80 x 180 x 3 h	PD380180(X)*	49,35	 <b>Gloss White</b>  <b>Le Terre di Cielo*</b>	1482,00 1732,00		
 <p><b>Siphon drain for shower tray Infinito H3 (mandatory)</b> Desagüe para plato de ducha Infinito H3 (obligatorio) Bonde avec siphon pour receveur de douche Infinito H3 (nécessaire) Ablaufgarnitur mit Siphon für Duschwanne Infinito H3 (geböten) Донный клапан с сифоном для душевого поддона Infinito H3 (обязателен)</p>		SIFPD	0,20		36,00		
 <p><b>Siphon with vertical drain for shower tray Infinito H3 (optional)</b> Desagüe para plato de ducha Infinito H3 (opcional) Bonde avec siphon avec sortie vertical pour receveur de douche Infinito H3 (sur demande) Ablaufgarnitur mit Siphon mit vertikalem Ablauf für Duschwanne Infinito H3 (wahlweise) Донный клапан с сифоном с вертикальным сливом для душевого поддона Infinito H3 (по желанию)</p>		SIFPDV	0,20		36,00		
 <p><b>Stainless steel grate for shower tray Infinito H3 (mandatory)</b> Rejilla en acero inox para plato de ducha Infinito H3 (obligatorio) Grille en acier inox pour receveur de douche Infinito H3 (nécessaire) Gitter aus Edelstahl für Duschwanne Infinito H3 (obligatorisch) Решетка из нержавеющей стали для душевого поддона Infinito H3 (обязательна)</p>		GRPD3	0,20	 <b>Polished steel</b> Acero pulido Acier poli brillant polierter Stahl Полированная сталь  <b>Le Terre di Cielo*</b>	45,00 59,00		

### Technical symbols legend

Simbolos técnicos clave | Légende symboles techniques | Technische Zeichenerklärung | Перечень технических символов



**all sides are enamelled**  
con todos los lados esmaltados  
avec tous les côtés émaillés  
alle Seiten glasiert  
все стороны покрыты эмалью

**floor installation**  
instalación de apoyo  
installation à poser  
Aufsatzmontage  
накладная установка

**recessed installation**  
instalación a ras de suelo  
installation à l'italienne au ras  
du sol  
bodenbündige Montage  
установка на пол

\* Terre di Cielo finishes available for shower tray | Acabados Terre di Cielo disponibles para Plato de ducha | Finitions Terre di Cielo disponibles pour Receveur de douche | Für das WC/Duschplatte erhältliche Ausführungen Terre di Cielo | оттенки Terre di Cielo доступны для Душевой поддон

 TL - Talco   
  PM - Pomice   
  BR - Brina   
  AN - Arenaria   
  LV - Lavagna   
  CA - Cacao  
 LN - Lino   
  BA - Basalto   
  AV - Avena   
  CM - Cemento   
  MU - Muschio   
  PL - Polvere

	Size (cm)	Product code	Net weight (Kg)	Finishes	Euro	Pz.	Pz.
	Medidas Dimensions Maße Размеры	Artículo Article Artikel Артикул	Peso neto Poids net Reingewicht вес нетто	Acabados Finitions Farbe Отделки	Евро	шт. pallet Italia	шт. pallet Cont.
 <p><b>Rectangular shower tray</b> Plato de ducha rectangular Receveur de douche rectangulaire rechteckige Duschplatte Душевой поддон прямоугольный</p>	90 x 120 x 3 h	PD390120(X)*	39,67	<p>● Gloss White</p> <p>● Le Terre di Cielo*</p>	896,00 1120,00		
 <p><b>Rectangular shower tray</b> Plato de ducha rectangular Receveur de douche rectangulaire rechteckige Duschplatte Душевой поддон прямоугольный</p>	90 x 140 x 3 h	PD390140(X)*	45,55	<p>● Gloss White</p> <p>● Le Terre di Cielo*</p>	1163,00 1363,00		
 <p><b>Rectangular shower tray</b> Plato de ducha rectangular Receveur de douche rectangulaire rechteckige Duschplatte Душевой поддон прямоугольный</p>	90 x 160 x 3 h	PD390160(X)*	56,95	<p>● Gloss White</p> <p>● Le Terre di Cielo*</p>	1363,00 1689,00		

### Technical symbols legend

Simbolos técnicos clave | Légende symboles techniques | Technische Zeichenerklärung | Перечень технических символов









**all sides are enamelled**  
con todos los lados esmaltados  
avec tous les côtés émaillés  
alle Seiten glasiert  
все стороны покрыты эмалью

**floor installation**  
instalación de apoyo  
installation à poser  
Aufsatzmontage  
накладная установка

**recessed installation**  
instalación a ras de suelo  
installation à l'italienne au ras  
du sol  
bodenbündige Montage  
установка на пол

\* Terre di Cielo finishes available for shower tray | Acabados Terre di Cielo disponibles para Plato de ducha | Finitions Terre di Cielo disponibles pour Receveur de douche | Für das WC/Duschplatte erhältliche Ausführungen Terre di Cielo | отделки Terre di Cielo доступны для Душевой поддон

● TL - Talco ● PM - Pomice ● BR - Brina ● AN - Arenaria ● LV - Lavagna ● CA - Cacao  
● LN - Lino ● BA - Basalto ● AV - Avena ● CM - Cemento ● MU - Muschio ● PL - Polvere

	Size (cm)	Product code	Net weight(Kg)	Finishes	Euro	Pz.	Pz.
	Medidas Dimensions Maße Размеры	Artículo Article Artikel Артикул	Peso neto Poids net Reingewicht вес нетто	Acabados Finitions Farbe Отделки	Евро	шт. pallet Italia	шт. pallet Cont.
 <p><b>Square shower tray</b> Plato de ducha square Receveur de douche carré Duschwanne Душевой поддон квадратный</p>	100 x 100 x 3 h	PD3100100(X)*	34,30	 <b>Gloss White</b>  <b>Le Terre di Cielo*</b>	864,00 1000,00		
 <p><b>Siphon drain for shower tray Infinito H3 (mandatory)</b> Desagüe para plato de ducha Infinito H3 (obligatorio) Bonde avec siphon pour receveur de douche Infinito H3 (nécessaire) Ablaufgarnitur mit Siphon für Duschwanne Infinito H3 (geböten) Донный клапан с сифоном для душевого поддона Infinito H3 (обязателен)</p>		SIFPD	0,20		36,00		
 <p><b>Siphon with vertical drain for shower tray Infinito H3 (optional)</b> Desagüe para plato de ducha Infinito H3 (opcional) Bonde avec siphon avec sortie vertical pour receveur de douche Infinito H3 (sur demande) Ablaufgarnitur mit Siphon mit vertikalem Ablauf für Duschwanne Infinito H3 (wahlweise) Донный клапан с сифоном с вертикальным сливом для душевого поддона Infinito H3 (по желанию)</p>		SIFPDV	0,20		36,00		
 <p><b>Stainless steel grate for shower tray Infinito H3 (mandatory)</b> Rejilla en acero inox para plato de ducha Infinito H3 (obligatorio) Grille en acier inox pour receveur de douche Infinito H3 (nécessaire) Gitter aus Edelstahl für Duschwanne Infinito H3 (obligatorisch) Решетка из нержавеющей стали для душевого поддона Infinito H3 (обязательна)</p>		GRPD3	0,20	 <b>Polished steel</b> Acero pulido Acier poli brillant polierter Stahl Полпированная сталь  <b>Le Terre di Cielo*</b>	45,00 59,00		

### Technical symbols legend

Simbolos técnicos clave | Légende symboles techniques | Technische Zeichenerklärung | Перечень технических символов

 **all sides are enamelled**  
con todos los lados esmaltados  
avec tous les côtés émaillés  
alle Seiten glasiert  
все стороны покрыты эмалью

 **floor installation**  
instalación de apoyo  
installation à poser  
Aufsatzmontage  
накладная установка

 **recessed installation**  
instalación a ras de suelo  
installation à l'italienne au ras  
du sol  
bodenbüdinge Montage  
установка на пол

\* Terre di Cielo finishes available for shower tray | Acabados Terre di Cielo disponibles para Plato de ducha | Finitions Terre di Cielo disponibles pour Receveur de douche | Für das WC/Duschplatte erhältliche Ausführungen Terre di Cielo | Отделку Terre di Cielo доступны для Душевой поддон

 TL - Talco   
  PM - Pomice   
  BR - Brina   
  AN - Arenaria   
  LV - Lavagna   
  CA - Cacao  
 LN - Lino   
  BA - Basalto   
  AV - Avena   
  CM - Cemento   
  MU - Muschio   
  PL - Polvere

## Finishes\_Acabados\_Finitions\_Farbe\_Отделки

 Gloss White

 **Le Terre di Cielo**

 TL - Talco

 PM - Pomice

 BR - Brina

 CM - Cemento

 BA - Basalto

 LV - Lavagna

 FN - Fango

 CA - Cacao

 AN - Arenaria

 AV - Avena

 MU - Muschio

 AG - Agave

 LN - Lino

 CN - Canapa

 CP - Cipria

 PL - Polvere

 **Antiscivolo / Non Slip**

 **TW - Total White**  
Antiscivolo - Non slip

**The possible variations of the colour cannot be considered as defect, but as a guarantee of the completely artisan manufacturing of this unique and high quality product.**

*Las variaciones de colores no se consideran un defecto sino una garantía de una elaboración manual y artesanal en un producto único y de calidad.*

*Les éventuelles variations de couleur ne peuvent être considérées comme des défauts, elles témoignent en revanche d'une méthode de travail totalement manuelle et artisanale employée pour obtenir un produit fini unique et de qualité.*

*Eventuelle Farbvariationen sind nicht als Mangel anzusehen, sondern als Garantie für die komplett handwerkliche Anfertigung eines einzigartigen und hochqualitativen Produkts.*

*Возможные вариации цвета не могут считаться дефектом, а являются подтверждением ручной работы, гарантией качества и уникальности изделия.*

## Shower Trays\_Bac a douche\_ Duschwanne\_ Душевой поддон

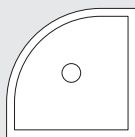

**PDCI690**  
90 x 90 x 6 h  
pag. 528

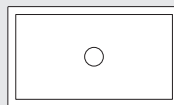

**PD670120**  
70 x 120 x 6 h  
pag. 529

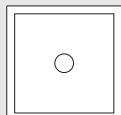

**PD68080**  
80 x 80 x 6 h  
pag. 528



**PD680120**  
80 x 120 x 6 h  
pag. 529

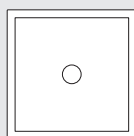

**PD69090**  
90 x 90 x 6 h  
pag. 528

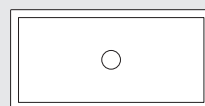

**PD670140**  
70 x 140 x 6 h  
pag. 529

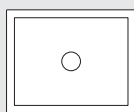

**PD67290**  
72 x 90 x 6 h  
pag. 528

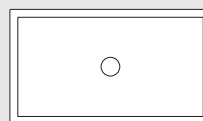

**PD680140**  
80 x 140 x 6 h  
pag. 529

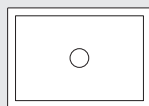

**PD670100**  
70 x 100 x 6 h  
pag. 528



























**PD680100**  
80 x 100 x 6 h  
pag. 528







	Size (cm)	Product code	Net weight(Kg)	Finishes	Euro	Pz.	Pz.
	Medidas Dimensions Maße Размеры	Artículo Article Artikel Артикул	Peso neto Poids net Reingewicht вес нетто	Acabados Finitions Farbe Отделки	Евро	шт. pallet Italia	шт. pallet Cont.
 <p><b>Corner shower tray 90</b> Plato de ducha angular 90 Receveur de douche d'angle 90 Eckduschanne 90 Душевой поддон угловой 90</p>	<b>90 x 90 x 6 h</b>	PDCI690(X)*	32,55	 <b>Non Slip*</b>  <b>Le Terre di Cielo</b>  <b>Gloss White</b>	<b>472,00</b> <b>542,00</b> <b>349,00</b>	15	
 <p><b>Square shower tray</b> Plato de ducha cuadro Receveur de douche carré Duschwanne Душевой поддон квадратный</p>	<b>80 x 80 x 6 h</b>	PD68080(X)*	27,20	 <b>Non Slip*</b>  <b>Le Terre di Cielo</b>  <b>Gloss White</b>	<b>297,00</b> <b>427,00</b> <b>266,00</b>	15	
 <p><b>Square shower tray</b> Plato de ducha cuadro Receveur de douche carré Duschwanne Душевой поддон квадратный</p>	<b>90 x 90 x 6 h</b>	PD69090(X)*	39,00	 <b>Non Slip*</b>  <b>Le Terre di Cielo</b>  <b>Gloss White</b>	<b>451,00</b> <b>542,00</b> <b>349,00</b>	15	
 <p><b>Rectangular shower tray</b> Plato de ducha rectangular Bac a douche rectangulaire Duschwanne rechteckig Душевой поддон квадратный</p>	<b>72 x 90 x 6 h</b>	PD67290(X)*	29,60	 <b>Non Slip*</b>  <b>Le Terre di Cielo</b>  <b>Gloss White</b>	<b>407,00</b> <b>529,00</b> <b>336,00</b>	15	
 <p><b>Rectangular shower tray</b> Plato de ducha rectangular Bac a douche rectangulaire Duschwanne rechteckig Душевой поддон квадратный</p>	<b>70 x 100 x 6 h</b>	PD670100(X)*	29,10	 <b>Non Slip*</b>  <b>Le Terre di Cielo</b>  <b>Gloss White</b>	<b>420,00</b> <b>555,00</b> <b>361,00</b>	15	
 <p><b>Rectangular shower tray</b> Plato de ducha rectangular Bac a douche rectangulaire Duschwanne rechteckig Душевой поддон квадратный</p>	<b>80 x 100 x 6 h</b>	PD680100(X)*	35,05	 <b>Non Slip*</b>  <b>Le Terre di Cielo</b>  <b>Gloss White</b>	<b>466,00</b> <b>618,00</b> <b>413,00</b>	15	































 **one side is unglazed /** con un lado sin esmaltar / avec un côté non émaillé / eine Seite unglasiert / одна сторона не покрыта эмалью

 **floor installation /** instalación de apoyo / installation à poser / Aufsatzmontage / накладная установка

 **recessed installation /** instalación a ras de suelo / installation à l'italienne / au ras du sol / bodenbündige Montage / установка на пол

\* **Non-slip finish is Total White** Para el antideslizante se hacen los acabados Total White / Par antidérapant nous entendons les finitions Total White / Nur die Fertigungen Total White sind antislip

- Le Terre di Cielo
-  TL - Talco
  -  PM - Pomice
  -  BR - Brina
  -  BA - Basalto
  -  LV - Lavagna
  -  CM - Cemento
  -  FN - Fango
  -  CA - Cacao
  -  AN - Arenaria
  -  AV - Avena
  -  LN - Lino
  -  AG - Agave
  -  MU - Muschio
  -  PL - Polvere
  -  CP - Cipria
  -  CN - Canapa

	Size (cm)	Product code	Net weight (Kg)	Finishes	Euro	Pz.	Pz.
	Medidas Dimensions Maße Размеры	Artículo Article Artikel Артикул	Peso neto Poids net Reingewicht вес нетто	Acabados Finitions Farbe Отделка	Евро	шт. pallet Italia	шт. pallet Cont.
  <p><b>Rectangular shower tray</b> Plato de ducha rectangular Bac a douche rectangulaire Duschwanne rechteckig Душевой поддон квадратный</p>	<b>70 x 120 x 6 h</b>	PD670120(X)*	40,10	 Non Slip*  Le Terre di Cielo  Gloss White	<b>609,00</b> <b>634,00</b> <b>427,00</b>	13	
  <p><b>Rectangular shower tray</b> Plato de ducha rectangular Bac a douche rectangulaire Duschwanne rechteckig Душевой поддон квадратный</p>	<b>80 x 120 x 6 h</b>	PD680120(X)*	45,50	 Non Slip*  Le Terre di Cielo  Gloss White	<b>645,00</b> <b>747,00</b> <b>510,00</b>	13	
  <p><b>Rectangular shower tray</b> Plato de ducha rectangular Bac a douche rectangulaire Duschwanne rechteckig Душевой поддон квадратный</p>	<b>70 x 140 x 6 h</b>	PD670140(X)*	42,00	 Non Slip*  Le Terre di Cielo  Gloss White	<b>902,00</b> <b>1031,00</b> <b>773,00</b>	13	
  <p><b>Rectangular shower tray</b> Plato de ducha rectangular Bac a douche rectangulaire Duschwanne rechteckig Душевой поддон квадратный</p>	<b>80 x 140 x 6 h</b>	PD680140(X)*	50,20	 Non Slip*  Le Terre di Cielo  Gloss White	<b>992,00</b> <b>1043,00</b> <b>812,00</b>	13	
 <p><b>Shower tray siphon with chrome cover</b> Valvula cromada para plato e ducha Bonde de douche chromée pour la gamme Duschwannen Ablauf verchromt Донный клапан для душевого поддона, хром</p>		SIF90	0,25	 Chrome	<b>48,00</b>		
 <p><b>Adaptable shower tray waste with ceramic cover</b> valvula desagüe con tapa de cerámica adaptable Bonde adaptable avec cache-écoulement en céramique Auslauf anpassungsfähig mit Deckel aus Keramik Донный клапан в комплекте с накладкой из керамики</p>		SIF90CE(X)*	0,50	 Non Slip*  Le Terre di Cielo  Gloss White	<b>123,00</b> <b>198,00</b> <b>99,00</b>		
 <p><b>Ceramic cover</b> Sólo tapa de cerámica para valvula Cache-écoulement en céramique Deckel aus Keramik Керамическая накладка для донного клапана</p>		COPCE(X)*	0,30	 Non Slip*  Le Terre di Cielo  Gloss White	<b>78,00</b> <b>132,00</b> <b>63,00</b>		

 **one side is unglazed** / con un lado sin esmaltar / avec un côté non émaillé / eine Seite unglasiert / одна сторона не покрыта эмалью

 **floor installation** / instalación de apoyo / installation à poser / Aufsatzmontage / накладная установка

 **recessed installation** / instalación a ras de suelo / installation à l'intérieur au ras du sol / bodenbündige Montage / установка на пол

\* **Non-slip finish is Total White** Para el antideslizante se hacen los acabados Total White / Par antidérapant nous entendons les finitions Total White / Nur die Fertigungen Total White sind antislip

- Le Terre di Cielo
-  TL - Talco
  -  PM - Pomice
  -  BR - Brina
  -  BA - Basalto
  -  LV - Lavagna
  -  CM - Cemento
  -  FN - Fango
  -  CA - Cacao
  -  AN - Arenaria
  -  AV - Avena
  -  LN - Lino
  -  AG - Agave
  -  MU - Muschio
  -  PL - Polvere
  -  CP - Cipria
  -  CN - Canapa

## Finishes\_Acabados\_Finitions\_Farbe\_Отделки



**B** - Bianco Matt  
*Matt White*



**TO** - Tortora Matt



**N** - Nero Matt  
*Matt Black*

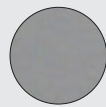

**GR** - Grigio Matt



**AR** - Ardesia Matt



**CR** - Crema Matt

**The possible variations of the colour cannot be considered as defect, but as a guarantee of the completely artisan manufacturing of this unique and high quality product.**

*Las variaciones de colores no se consideran un defecto sino una garantía de una elaboración manual y artesanal en un producto único y de calidad.*

*Les éventuelles variations de couleur ne peuvent être considérées comme des défauts, elles témoignent en revanche d'une méthode de travail totalement manuelle et artisanale employée pour obtenir un produit fini unique et de qualité.*

*Eventuelle Farbvariationen sind nicht als Mangel anzusehen, sondern als Garantie für die komplett handwerkliche Anfertigung eines einzigartigen und hochqualitativen Produkts.*

*Возможные вариации цвета не могут считаться дефектом, а являются подтверждением ручной работы, гарантией качества и уникальности изделия.*



## Shower Trays\_Bac a douche\_Duschwanne\_Душевой поддон



**PDR8080**  
80 x 80 x 2,5 h  
pag. 536



**PDR9070**  
70 x 90 x 2,5 h  
pag. 536



**PDR10080**  
80 x 100 x 2,5 h  
pag. 536



**PDR14090**  
90 x 140 x 2,5 h  
pag. 537



**PDR140100**  
100 x 140 x 2,5 h  
pag. 537



**PDR9090**  
90 x 90 x 2,5 h  
pag. 536



**PDR10070**  
70 x 100 x 2,5 h  
pag. 536



**PDR12080**  
80 x 120 x 2,5 h  
pag. 536



**PDR15090**  
90 x 150 x 2,5 h  
pag. 537



**PDR150100**  
100 x 150 x 2,5 h  
pag. 537



**PDR12070**  
70 x 120 x 2,5 h  
pag. 536



**PDR14080**  
80 x 140 x 2,5 h  
pag. 536



**PDR16090**  
90 x 160 x 2,5 h  
pag. 537



**PDR160100**  
100 x 160 x 2,5 h  
pag. 537



**PDR14070**  
70 x 140 x 2,5 h  
pag. 536



**PDR15080**  
80 x 150 x 2,5 h  
pag. 536



**PDR17090**  
90 x 170 x 2,5 h  
pag. 537



**PDR170100**  
100 x 170 x 2,5 h  
pag. 537



**PDR15070**  
70 x 150 x 2,5 h  
pag. 536



**PDR16080**  
80 x 160 x 2,5 h  
pag. 536



**PDR18090**  
90 x 180 x 2,5 h  
pag. 537



**PDR180100**  
100 x 180 x 2,5 h  
pag. 537



**PDR16070**  
70 x 160 x 2,5 h  
pag. 536



**PDR17080**  
80 x 170 x 2,5 h  
pag. 536



**PDR19090**  
90 x 190 x 2,5 h  
pag. 537



**PDR190100**  
100 x 190 x 2,5 h  
pag. 537



**PDR17070**  
70 x 170 x 2,5 h  
pag. 536

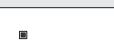

**PDR18080**  
80 x 180 x 2,5 h  
pag. 536



**PDR20090**  
90 x 200 x 2,5 h  
pag. 537



**PDR200100**  
100 x 200 x 2,5 h  
pag. 537

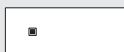

**PDR18070**  
70 x 180 x 2,5 h  
pag. 536



**PDR19080**  
80 x 190 x 2,5 h  
pag. 536

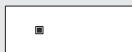

**PDR19070**  
70 x 190 x 2,5 h  
pag. 536

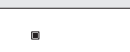

**PDR20080**  
80 x 200 x 2,5 h  
pag. 536



**PDR20070**  
70 x 200 x 2,5 h  
pag. 536



## Custom cuts examples

Tutti i piatti doccia della Collezione Venticinque sono reversibili, cioè è possibile installarli con la piletta posizionata a destra o a sinistra. La misura minima è 90x70 cm. La misura massima è 200x100 cm. Tutte le richieste di personalizzazione dovranno essere comprese nell'intervallo di queste misure minime e massime. Non sono possibili tagli curvi.

en

**All shower trays of Venticinque Collection are reversible, in other words, you can install them with right or left waste.**  
**The smallest available size is 90x70 cms.**  
**The biggest available size is 200x100 cms.**  
**All bespoke requests cannot get beyond smallest/biggest available size.**  
**Rounded cuts are not realizable.**

fr

Tous receveur de douche de la Collection Venticinque sont réversibles, c'est-à-dire que la pose peut être avec bonde à droite autant qu'à gauche. La mesure, la plus petite possible est de 90x70cm. La mesure, la plus grand possible est de 200x100cm." Les découpages courbes ne sont pas réalisables.

N.B. Per i piatti doccia con misure fuori standard e per tutti i tagli su misura sarà addebitato un costo ulteriore di euro 25 a pezzo (prezzo netto + IVA) con riferimento alla misura standard immediatamente superiore a quella richiesta.

en

**N.B. For shower trays with non-standard size and/or custom cuts € 25,00 (net price + VAT) will be added to the listed price of the standard size that would allow the customization.**

fr

Pour tous les receveurs de douche avec mesures pas conventionnelles et pour les personnalisations du produit, l'entreprise appliquera un coût supplémentaire de 25,00€ avec référence à la mesure standard immédiatement supérieure à celle commandé.

sp

N.B. Para platos de ducha con medidas no estándar y para todos los cortes a medida se cobrará un suplemento de 25 € por unidad (precio neto + IVA) , con referencia a la medida estándar inmediatamente superior a la solicitada.

de

N.B. Zur Berechnung einer Duschtasse ausserhalb der Standardmasse ist der Preis für die nach dem Wunschmass nächstgrößere Standardduschtasse + zzgl. noch einmal 25,00 € zu nehmen.

DX

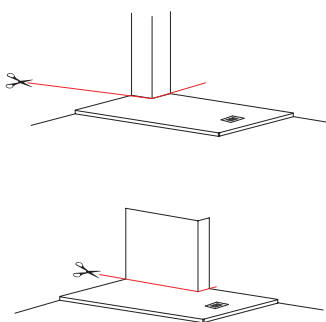

SX

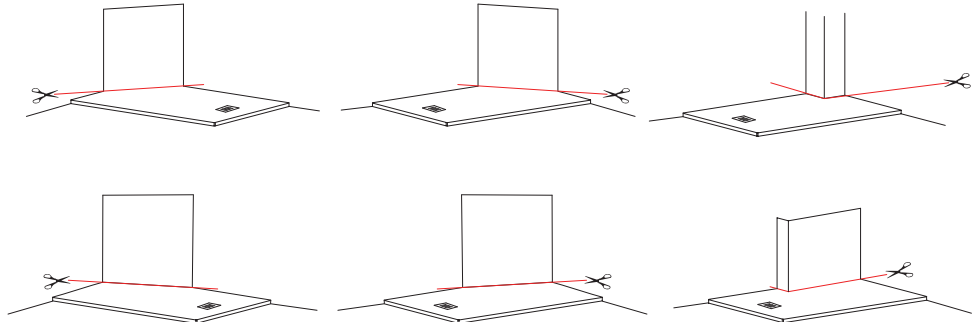

DX

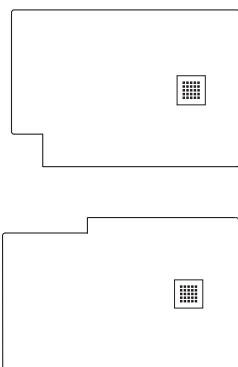

SX

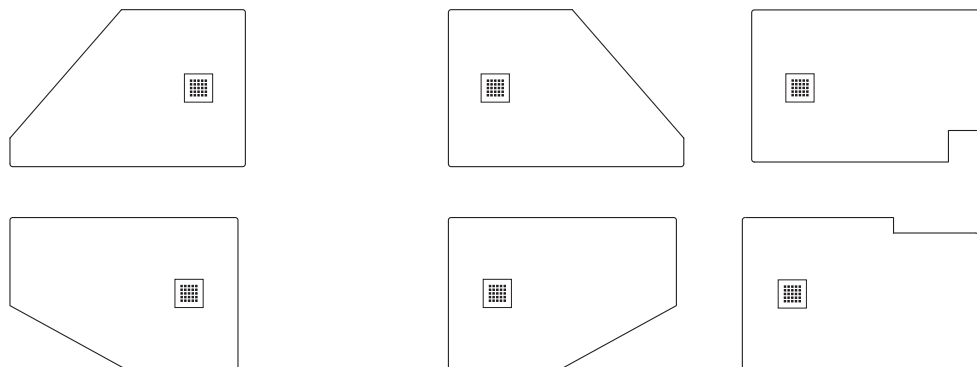

## Custom Cut Request form

 = 5 cm

\* 

Indicare negli appositi rettangoli \* la misura finale del piatto doccia e disegnare sullo schema le linee di taglio.

**en: Indicate into the graphic \* the definitive shower tray size and draw on it all cut lines.**

**fr: Indiquer dans les rectangles \* la mesure définitive du receveur de douche et après, indiquer sur le dessin les lignes du découpage.**

Tutte le richieste dovranno essere specificamente valutate ed approvate dal Nostro Ufficio Tecnico.

**en: All bespoke requests must be valued and approved by our technical staff.**

**fr: Tous demandes de personnalisation seront évaluées et approuvées de notre staff technique.**

\_\_\_\_\_ for customer approvance  
*timbro e firma del cliente*



**NB:** Non è possibile effettuare tagli nella zona evidenziata in grigio.



**Note:** It is not possible to cut the product in the grey area.

**Attention:** On n'a pas la possibilité d'effectuer modifications dans la partie indiquée en gris.



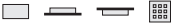

 <b>Square shower tray shower tray</b> Plato de ducha cuadro reversible Receveur de douche carré et réversible Umdrehbare rechteckige Duschplatte Душевой поддон квадратный реверсивный	Size (cm)	Product code	Net weight (Kg)	Finishes	Euro	Pz.	Pz.
	Medidas Dimensions Maße Размеры	Artículo Article Artikel Артикул	Peso neto Poids net Reingewicht вес нетто	Acabados Finitions Farbe Отделки	Евро	шт. pallet Italia	шт. pallet Cont.
	<b>80 x 80 x 2,5 h</b>	PDR8080(x)*	23,30	● <b>Marmogres</b>	<b>706,00</b>		
	<b>90 x 90 x 2,5 h</b>	PDR9090(x)*	29,50	● <b>Marmogres</b>	<b>736,00</b>		
 <b>Rectangular and reversible shower tray</b> Plato de ducha rectangular reversible Receveur de douche rectangulaire et réversible Umdrehbare rechteckige Duschplatte Душевой поддон прямоугольный реверсивный	<b>70 x 90 x 2,5 h</b>	PDR9070(x)*	23,00	● <b>Marmogres</b>	<b>546,00</b>		
	<b>70 x 100 x 2,5 h</b>	PDR10070(x)*	25,50	● <b>Marmogres</b>	<b>577,00</b>		
	<b>70 x 120 x 2,5 h</b>	PDR12070(x)*	30,60	● <b>Marmogres</b>	<b>640,00</b>		
	<b>70 x 140 x 2,5 h</b>	PDR14070(x)*	35,70	● <b>Marmogres</b>	<b>763,00</b>		
	<b>70 x 150 x 2,5 h</b>	PDR15070(x)*	38,20	● <b>Marmogres</b>	<b>810,00</b>		
	<b>70 x 160 x 2,5 h</b>	PDR16070(x)*	40,80	● <b>Marmogres</b>	<b>871,00</b>		
	<b>70 x 170 x 2,5 h</b>	PDR17070(x)*	43,30	● <b>Marmogres</b>	<b>944,00</b>		
	<b>70 x 180 x 2,5 h</b>	PDR18070(x)*	45,90	● <b>Marmogres</b>	<b>956,00</b>		
	<b>70 x 190 x 2,5 h</b>	PDR19070(x)*	48,40	● <b>Marmogres</b>	<b>1080,00</b>		
	<b>70 x 200 x 2,5 h</b>	PDR20070(x)*	51,00	● <b>Marmogres</b>	<b>1104,00</b>		
	<b>80 x 100 x 2,5 h</b>	PDR10080(x)*	29,10	● <b>Marmogres</b>	<b>614,00</b>		
	<b>80 x 120 x 2,5 h</b>	PDR12080(x)*	35,00	● <b>Marmogres</b>	<b>683,00</b>		
	<b>80 x 140 x 2,5 h</b>	PDR14080(x)*	40,80	● <b>Marmogres</b>	<b>846,00</b>		
	<b>80 x 150 x 2,5 h</b>	PDR15080(x)*	43,70	● <b>Marmogres</b>	<b>896,00</b>		
	<b>80 x 160 x 2,5 h</b>	PDR16080(x)*	46,60	● <b>Marmogres</b>	<b>944,00</b>		
	<b>80 x 170 x 2,5 h</b>	PDR17080(x)*	49,50	● <b>Marmogres</b>	<b>1030,00</b>		
<b>80 x 180 x 2,5 h</b>	PDR18080(x)*	52,40	● <b>Marmogres</b>	<b>1061,00</b>			
<b>80 x 190 x 2,5 h</b>	PDR19080(x)*	55,30	● <b>Marmogres</b>	<b>1165,00</b>			
<b>80 x 200 x 2,5 h</b>	PDR20080(x)*	58,30	● <b>Marmogres</b>	<b>1188,00</b>			

	Size (cm)	Product code	Net weight (Kg)	Finishes	Euro	Pz.	Pz.
	Medidas Dimensions Maße Размеры	Artículo Article Artikel Артикул	Peso neto Poids net Reingewicht вес нетто	Acabados Finitions Farbe Отделки	Евро	шт. pallet Italia	шт. pallet Cont.
  <p><b>Rectangular and reversible shower tray</b> Plato de ducha rectangular reversible Receveur de douche rectangulaire et réversible Umdrehbare rechteckige Duschplatte Душевой поддон прямоугольный реверсивный</p>	<b>90 x 140 x 2,5 h</b>	PDR14090(X)*	45,90	● <b>Marmogres</b>	<b>956,00</b>		
	<b>90 x 150 x 2,5 h</b>	PDR15090(X)*	49,20	● <b>Marmogres</b>	<b>1018,00</b>		
	<b>90 x 160 x 2,5 h</b>	PDR16090(X)*	52,40	● <b>Marmogres</b>	<b>1055,00</b>		
	<b>90 x 170 x 2,5 h</b>	PDR17090(X)*	56,70	● <b>Marmogres</b>	<b>1164,00</b>		
	<b>90 x 180 x 2,5 h</b>	PDR18090(X)*	59,00	● <b>Marmogres</b>	<b>1239,00</b>		
	<b>90 x 190 x 2,5 h</b>	PDR19090(X)*	62,30	● <b>Marmogres</b>	<b>1289,00</b>		
	<b>90 x 200 x 2,5 h</b>	PDR20090(X)*	65,50	● <b>Marmogres</b>	<b>1348,00</b>		
	<b>100 x 140 x 2,5 h</b>	PDR140100(X)*	51,00	● <b>Marmogres</b>	<b>1066,00</b>		
	<b>100 x 150 x 2,5 h</b>	PDR150100(X)*	54,60	● <b>Marmogres</b>	<b>1147,00</b>		
	<b>100 x 160 x 2,5 h</b>	PDR160100(X)*	58,30	● <b>Marmogres</b>	<b>1196,00</b>		
	<b>100 x 170 x 2,5 h</b>	PDR170100(X)*	61,90	● <b>Marmogres</b>	<b>1294,00</b>		
	<b>100 x 180 x 2,5 h</b>	PDR180100(X)*	65,50	● <b>Marmogres</b>	<b>1385,00</b>		
	<b>100 x 190 x 2,5 h</b>	PDR190100(X)*	69,20	● <b>Marmogres</b>	<b>1427,00</b>		
	<b>100 x 200 x 2,5 h</b>	PDR200100(X)*	72,80	● <b>Marmogres</b>	<b>1576,00</b>		

## Technical symbols legend

Simbolos técnicos clave / Légende symboles techniques / Technische Zeichenerklärung / Перечень технических символов

 **all sides are enamelled**  
con todos los lados esmaltados  
avec tous les côtés émaillés  
alle Seiten glasiert  
все стороны покрыты эмалью

 **floor installation**  
instalación de apoyo  
installation à poser  
Aufsatzmontage  
накладная установка

 **recessed installation**  
instalación a ras de suelo  
installation à l'italienne au ras du sol  
bodenbündige Montage  
установка на пол

 **with grate and siphon**  
avec grille et siphon  
avec siphon et grille inclus  
inklusive Siphon und Gitter  
сифон и решетка входят в комплект

Marmogres

● **B - Bianco**  
Matt

● **N - Nero**  
Matt

● **AR - Ardesia**  
Matt

● **TO - Tortora**  
Matt

● **GR - Grigio**  
Matt

● **CR - Crema**  
Matt







**piatto doccia Augusto in ceramica**

Augusto ceramic shower tray  
cm 106 x 106 x 20 h  
pg. 540

## Finiture\_Acabados\_Finitions\_Farbe\_Отделки

 **Bianco Lucido**





### Le Terre di Cielo

 **TL - Talco**

 **PM - Pomice**

 **BR - Brina**

 **CM - Cemento**

 **BA - Basalto**

 **LV - Lavagna**

 **FN - Fango**

 **CA - Cacao**

 **AN - Arenaria**

 **AV - Avena**

 **MU - Muschio**

 **AG - Agave**

 **LN - Lino**

 **CN - Canapa**

 **CP - Cipria**

 **PL - Polvere**





### Le Acque di Cielo

 **OL - Oltremare**

 **SM - Smeraldo**

 **AL - Alga**

 **CO - Corallo**

 **NI - Ninfea**

 **AM - Anemone**

The possible variations of the colour cannot be considered as defect, but as a guarantee of the completely artisan manufacturing of this unique and high quality product.

Las variaciones de colores no se consideran un defecto sino una garantía de una elaboración manual y artesanal en un producto único y de calidad.

Les éventuelles variations de couleur ne peuvent être considérées comme des défauts, elles témoignent en revanche d'une méthode de travail totalement manuelle et artisanale employée pour obtenir un produit fini unique et de qualité.















Eventuelle Farbvariationen sind nicht als Mangel anzusehen, sondern als Garantie für die komplett handwerkliche Anfertigung eines einzigartigen und hochqualitativen Produkts.

Возможные вариации цвета не могут считаться дефектом, а являются подтверждением ручной работы, гарантией качества и уникальности изделия.

# I Catini - Augusto

shower tray / plato de ducha / Receveur de douche / Duschwanne / Душевой поддон

# cielo

	Size (cm)	Product code	Net weight (Kg)	Finishes	Euro	Pz.	Pz.
	Medidas Dimensions Maße Размеры	Artículo Article Artikel Артикул	Peso neto Poids net Reingewicht вес нетто	Acabados Finitions Farbe Отделки	Евро	шт. pallet Italia	шт. pallet Cont.
 <p><b>Augusto Shower tray</b> Plato de ducha Augusto Receveur de douche Augusto Duschwanne Augusto Душевой поддон Augusto</p>	106 x 106 x h20	PDCA106(X)*	76,50	<ul style="list-style-type: none"> <li> <b>Gloss White</b></li> <li> <b>Le Terre di Cielo</b></li> <li> <b>Le Acque di Cielo</b></li> </ul>	1329,00 1733,00 1733,00		
 <p><b>Shower tray siphon with chrome cover</b> Valvula cromada para plato e ducha Bonde de douche chromée pour la gamme Duschwannen Ablauf verchromt Донный клапан для душевого поддона, хром</p>		SIF90	0,25	<ul style="list-style-type: none"> <li> <b>Chrome</b></li> </ul>	48,00		
 <p><b>Adaptable shower tray waste with ceramic cover</b> valvula desagüe con tapa de cerámica adaptable Bonde adaptable avec cache-écoulement en céramique Auslauf anpassungsfähig mit Deckel aus Keramik Донный клапан в комплекте с накладкой из керамики</p>		SIF90CE(X)*	0,50	<ul style="list-style-type: none"> <li> <b>Glossy White</b></li> <li> <b>Le Terre di Cielo</b></li> <li> <b>Le Acque di Cielo</b></li> </ul>	99,00 198,00 198,00		
 <p><b>Ceramic cover</b> Sólo tapa de cerámica para valvula Cache-écoulement en céramique Deckel aus Keramik Керамическая накладка для донного клапана</p>		COPCE(X)*	0,30	<ul style="list-style-type: none"> <li> <b>Glossy White</b></li> <li> <b>Le Terre di Cielo</b></li> <li> <b>Le Acque di Cielo</b></li> </ul>	63,00 132,00 132,00		

## Technical symbols legend

Simbolos técnicos clave | Légende symboles techniques | Technische Zeichenerklärung | Перечень технических символов

 **floor installation**  
instalación de apoyo  
installation à poser  
Aufsatzmontage  
накладная установка

**Le Terre di Cielo**  TL - Talco  PM - Pomice  BR - Brina  BA - Basalto  LV - Lavagna  CM - Cemento  FN - Fango  CA - Cacao  
 AN - Arenaria  AV - Avena  LN - Lino  AG - Agave  MU - Muschio  PL - Polvere  CP - Cipria  CN - Canapa  
**Le Acque di Cielo**  OL - Oltremare  SM - Smeraldo  AL - Alga  CO - Corallo  NI - Ninfea  AM - Anemone

	Size (cm)	Product code	Net weight (Kg)	Finishes	Euro	Pz.	Pz.
	Medidas Dimensions Maße Размеры	Artículo Article Artikel Артикул	Peso neto Poids net Reingewicht вес нетто	Acabados Finitions Farbe Отделки	Евро	шт. pallet Italia	шт. pallet Cont.
 <p><b>Shower rod</b> estructura de cortina / mât pour drapeau / Vorhangstange /</p> <p><b>The shower rod is height adjustable. We recommend using 2 curtains 150 cm wide and 220 or 240 cm high. N.B. in order to avoid water leakage it is advisable to make sure that the curtain hangs inside the shower tray by at least 4 cms.</b> / La barra de la ducha es regulable en altura. Se recomienda usar 2 cortinas de ancho 150 cm y 220/240 cm de altura. P.D. Es aconsejable que la cortina entre en el plato de ducha de al menos 4 cm / La barre de douche est réglable en hauteur. Nous recommandons d'utiliser 2 rideaux de 150 cm de large et de 220/240 cm de haut. NB: Il est conseillé de veiller à ce que le rideau entre dans le receveur de douche sur au moins 4 cm pour éviter les fuites d'eau. / Die Vorhangstange ist höhenverstellbar. Wir empfehlen den Einsatz von zwei Vorhangbahnen mit Breite 150 cm und Höhe 220/240 cm. Hinweis: Der Vorhang sollte mindestens 4 cm in die Duschwanne hineinreichen, um dem Austreten von Wasser vorzubeugen. / Штанга для душа регулируется по высоте. Мы рекомендуем использовать 2 шторы шириной 150 см и высотой 220/240 см. Примечание: убедитесь, что штора минимально входит в душевой поддон 4 см, во избежание утечки воды.</p>		CAAS(x)*	2,50	<ul style="list-style-type: none"> <li>● X* = <b>NM - Matt Black</b></li> <li>● X* = <b>CM - Cemento</b></li> </ul>	551,00		
					561,00		

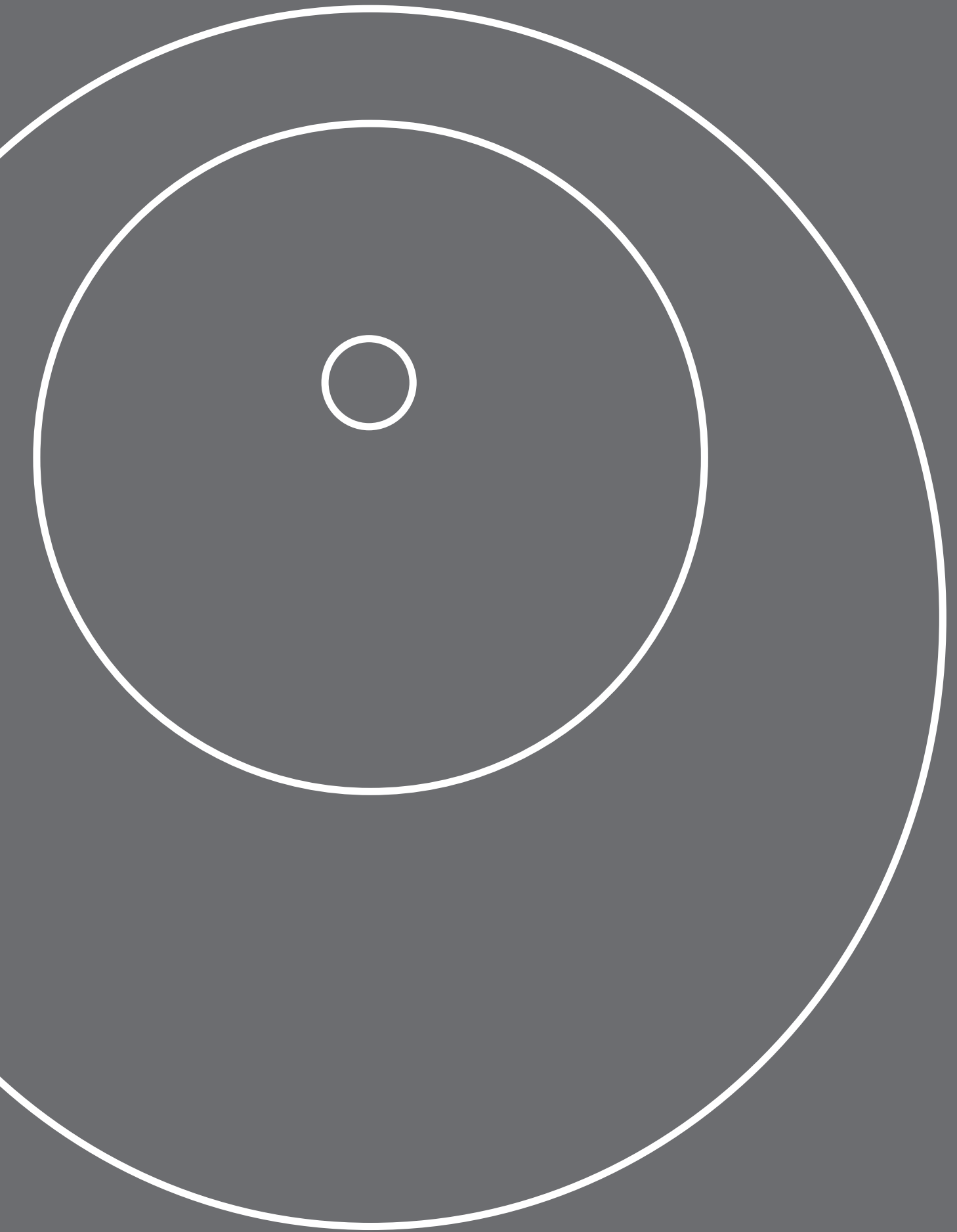

# Orinatoï

## Mini Ball

design 5.5 Designers

## Era

design Luca Cimarra



## Mini Ball Urinal finishes

Acabados de Urinario  
Finitions de l'urinoir  
Urinal Farbe  
Отделки писсуар

-  Gloss White
-  N - Gloss Black

## Le Terre di Cielo

-  TL - Talco
-  PM - Pomice
-  BR - Brina
-  CM - Cemento
-  BA - Basalto
-  LV - Lavagna
-  FN - Fango
-  CA - Cacao
-  AN - Arenaria
-  AV - Avena
-  MU - Muschio
-  AG - Agave
-  LN - Lino
-  CN - Canapa
-  CP - Cipria
-  PL - Polvere

## Era Urinal finishes

Acabados de Urinario  
Finitions de l'urinoir  
Urinal Farbe  
Отделки писсуар

-  Gloss White

## Le Terre di Cielo

-  TL - Talco
-  PM - Pomice
-  BR - Brina
-  CM - Cemento
-  BA - Basalto
-  LV - Lavagna
-  FN - Fango
-  CA - Cacao
-  AN - Arenaria
-  AV - Avena
-  MU - Muschio
-  AG - Agave
-  LN - Lino
-  CN - Canapa
-  CP - Cipria
-  PL - Polvere

**The possible variations of the colour cannot be considered as defect, but as a guarantee of the completely artisan manufacturing of this unique and high quality product.**

*Las variaciones de colores no se consideran un defecto sino una garantía de una elaboración manual y artesanal en un producto único y de calidad.*

*Les éventuelles variations de couleur ne peuvent être considérées comme des défauts, elles témoignent en revanche d'une méthode de travail totalement manuelle et artisanale employée pour obtenir un produit fini unique et de qualité.*

*Eventuelle Farbvariationen sind nicht als Mangel anzusehen, sondern als Garantie für die komplett handwerkliche Anfertigung eines einzigartigen und hochqualitativen Produkts.*

*Возможные вариации цвета не могут считаться дефектом, а являются подтверждением ручной работы, гарантией качества и уникальности изделия.*

## Mini Ball

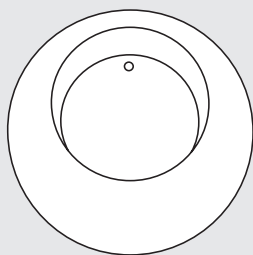

**ORBLM**  
47 x 24 x 50 h  
pag. 547

## Era

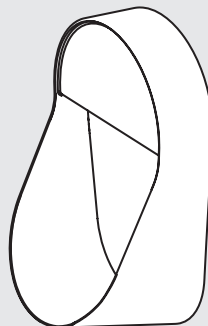

**EROR**  
33,5 x 27 x 63 h  
pag. 549



	Size (cm)	Product code	Net weight(Kg)	Finishes	Euro	Pz.	Pz.
	Medidas Dimensions Maße Размеры	Artículo Article Artikel Артикул	Peso neto Poids net Reingewicht вес нетто	Acabados Finitions Farbe Отделки	Евро	шт. pallet Italia	шт. pallet Cont.
 <p><b>Mini Ball wall-hung Urinal</b>                      Urinario suspendido Mini Ball                      Urinoir suspendu Mini Ball                      Wand-Urinal Mini Ball                      писсуар подвесной Mini Ball</p>	47 x 24 x 50 h	ORB <sup>LM</sup> (X)*	15,55	● Gloss White ● *X = N - Gloss Black ● Le Terre di Cielo	513,00 759,00 894,00	10	20
<p><b>Fixing, dispensing and siphon kit for urinal Ball, Mini Ball (mandatory)</b>                      Kit montaje-entrega-sifón urinario Ball, Mini Ball (obligatorio). / Accessoires de fixation, chasse et siphon pour urinoir Ball, Mini Ball (nécessaire) / Befestigungen und Ablaufschlauch Set für Urinal Ball, Mini Ball (geböten) / Комплект для крепления/подачи воды в писсуар Ball, Mini Ball (обязательный)</p>		ORKITB(X)*	0,50	● *X = B - White ● *X = C - Chrome	108,00 112,00		

**! N.B. The flush mechanism is not included**  
 El kit no incluye el mecanismo de descarga / Le kit ne comprend pas le mécanisme de chasse d'eau / Achtung: Der Spülmechanismus ist im Set nicht enthalten / Примечание: сливной механизм в комплект не входит

**Technical symbols legend**  
 Símbolos técnicos clave | Légende symboles techniques | Technische Zeichenerklärung | Перечень технических символов

 **wall-hung installation**  
 instalación suspendida  
 installation suspendue  
 wandhängende Montage  
 подвесная установка

 **one side is unglazed**  
 con un lado sin esmaltar  
 avec un côté non émaillé  
 eine Seite unglasiert  
 одна сторона не покрыта эмалью

- Le Terre di Cielo
- TL - Talco
  - PM - Pomice
  - BR - Brina
  - BA - Basalto
  - LV - Lavagna
  - CM - Cemento
  - FN - Fango
  - CA - Cacao
  - AN - Arenaria
  - AV - Avena
  - LN - Lino
  - AG - Agave
  - MU - Muschio
  - PL - Polvere
  - CP - Cipria
  - CN - Canapa







## Wall-hung urinal

Urinario suspendido \ Urinoir suspendu  
Wand-Urinal \ писсуар подвесной

Size (cm)	Product code	Net weight (Kg)	Finishes	Euro	Pz.	Pz.
Medidas Dimensions Maße Размеры	Artículo Article Artikel Артикул	Peso neto Poids net Reingewicht вес нетто	Acabados Finitions Farbe Отделки	Евро	шт. pallet Italia	шт. pallet Cont.
33,5 x 27 x 63h	EROR(X)*		<ul style="list-style-type: none"> <li><span style="display: inline-block; width: 10px; height: 10px; background-color: white; border: 1px solid black; border-radius: 50%;"></span> Gloss White</li> <li><span style="display: inline-block; width: 10px; height: 10px; background-color: #444; border-radius: 50%;"></span> Le Terre di Cielo</li> </ul>	<p>613,00</p> <p>855,00</p>	16	32
<p><b>!</b></p> <p><b>Fixing, dispensing and siphon kit for urinal Era (mandatory)</b></p> <p>Kit montaje/entrega/sifón urinario Era (obligatorio) Accessoires de fixation, chasse et siphon pour urinoir Era (nécessaire) / Befestigungen und Ablaufschlauch Set für Urinal Era (geböten) / Комплект для крепления/подачи воды в писсуар (обязательный)</p>	ORKITER(X)*		<ul style="list-style-type: none"> <li><span style="display: inline-block; width: 10px; height: 10px; background-color: white; border: 1px solid black; border-radius: 50%;"></span> *X = B - White</li> </ul>	130,00		



## N.B. The flush mechanism is not included

El kit no incluye el mecanismo de descarga / Le kit ne comprend pas le mécanisme de chasse d'eau / Achtung: Der Spülmechanismus ist im Set nicht enthalten / Примечание: сливной механизм в комплект не входит

### Technical symbols legend

Símbolos técnicos clave | Légende symboles techniques | Technische Zeichenerklärung | Перечень технических символов

**wall-hung installation**  
instalación suspendida  
installation suspendue  
wandhängende Montage  
подвесная установка

**one side is unglazed**  
con un lado sin esmaltar  
avec un côté non émaillé  
eine Seite unglasiert  
одна сторона не покрыта эмалью

Le Terre di Cielo





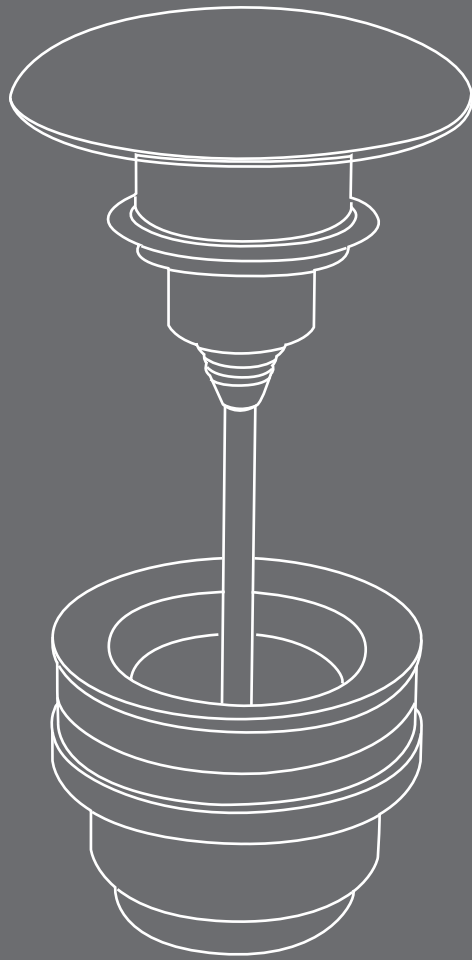



























- TL - Talco
- PM - Pomice
- BR - Brina
- BA - Basalto
- LV - Lavagna
- CM - Cemento
- FN - Fango
- CA - Cacao
- AN - Arenaria
- AV - Avena
- LN - Lino
- AG - Agave
- MU - Muschio
- PL - Polvere
- CP - Cipria
- CN - Canapa

































# **Ricambi / Accessori**

*Spare Parts / Accessories*

	<b>Product code</b> Artículo Article Artikel Артикул	<b>Net weight</b> (Kg) Peso neto Poids net Reingewicht вес нетто	<b>Finishes</b> Acabados Finitions Farbe Отделки	<b>Euro</b> Евро
 <p><b>Universal click/clack drain in CHROME with ceramic lid</b> Válvula universal click/clack Cromado con tapa en cerámica Bonde universelle clic/clac Chromé avec clapet en céramique Universal-Abflussgarnitur Click-Clack Chrom mit Keramikstopfen Универсальный донный клапан click/clack хром с керамической крышкой</p>	PIL01(X)*	0,40	<ul style="list-style-type: none"> <li> <b>Gloss White</b></li> <li> <b>N - Black</b></li> <li> <b>Le Terre di Cielo</b></li> <li> <b>Le Pietre</b></li> <li> <b>Le Acque di Cielo</b></li> </ul>	<p><b>95,00</b></p> <p><b>114,00</b></p> <p><b>139,00</b></p> <p><b>148,00</b></p> <p><b>139,00</b></p>
 <p><b>Universal click/clack drain in BLACK MATT finish with ceramic lid</b> Válvula universal click/clack Negro Matt con tapa en cerámica Bonde universelle clic/clac Noir Mat avec clapet en céramique Universal-Abflussgarnitur Click-Clack Matt Schwarz mit Keramikstopfen Универсальный донный клапан click/clack черный матовый с керамической крышкой</p>	PIL01NM(X)*	0,40	<ul style="list-style-type: none"> <li> <b>Gloss White</b></li> <li> <b>N - Black</b></li> <li> <b>Le Terre di Cielo</b></li> <li> <b>Le Pietre</b></li> <li> <b>Le Acque di Cielo</b></li> </ul>	<p><b>120,00</b></p> <p><b>159,00</b></p> <p><b>169,00</b></p> <p><b>185,00</b></p> <p><b>169,00</b></p>
 <p><b>Universal click/clack drain in CEMENTO finish with ceramic lid</b> Válvula universal click/clack Cemento con tapa en cerámica Bonde universelle clic/clac Cemento avec clapet en céramique Universal-Abflussgarnitur Click-Clack Cement mit Keramikstopfen Универсальный донный Cemento click/clack с керамической крышкой</p>	PIL01CM(X)*	0,40	<ul style="list-style-type: none"> <li> <b>Gloss White</b></li> <li> <b>N - Black</b></li> <li> <b>Le Terre di Cielo</b></li> <li> <b>Le Pietre</b></li> <li> <b>Le Acque di Cielo</b></li> </ul>	<p><b>120,00</b></p> <p><b>159,00</b></p> <p><b>169,00</b></p> <p><b>185,00</b></p> <p><b>169,00</b></p>
 <p><b>Universal click/clack drain in BRONZE with ceramic lid</b> Válvula universal click/clack Bronce con tapa en cerámica Bonde universelle clic/clac Bronze avec clapet en céramique Universal-Abflussgarnitur Click-Clack Bronze mit Keramikstopfen Универсальный донный клапан click/clack бронза с керамической крышкой</p>	PIL01BR(X)*	0,40	<ul style="list-style-type: none"> <li> <b>Gloss White</b></li> <li> <b>N - Black</b></li> <li> <b>Le Terre di Cielo</b></li> <li> <b>Le Pietre</b></li> <li> <b>Le Acque di Cielo</b></li> </ul>	<p><b>135,00</b></p> <p><b>171,00</b></p> <p><b>182,00</b></p> <p><b>185,00</b></p> <p><b>182,00</b></p>
 <p><b>CHROMED siphon</b> Sifone Cromado Siphon Chromé Siphon Verchromt сифон Chrome</p>	SISP	0,93	<ul style="list-style-type: none"> <li> <b>Chrome</b></li> </ul>	<b>133,00</b>
 <p><b>MATT BLACK siphon</b> Sifone Negro Mate Siphon Noir Mat Siphon Schwarz Matt Сифон Черный матовый</p>	SIFN	0,93	<ul style="list-style-type: none"> <li> <b>Matt Black</b></li> </ul>	<b>194,00</b>
 <p><b>CEMENTO siphon</b> Sifone Cemento Siphon Cemento Siphon Cemento сифон Cemento</p>	SIFCM	0,93	<ul style="list-style-type: none"> <li> <b>Cemento</b></li> </ul>	<b>194,00</b>
 <p><b>BRONZE siphon</b> Sifone Bronce Siphon Bronze Siphon Bronze бронза сифон</p>	SIFBR	0,93	<ul style="list-style-type: none"> <li> <b>Bronze</b></li> </ul>	<b>220,00</b>

- Le Terre di Cielo  TL - Talco  PM - Pomice  BR - Brina  BA - Basalto  LV - Lavagna  CM - Cemento  FN - Fango  CA - Cacao
-  AN - Arenaria  AV - Avena  LN - Lino  AG - Agave  MU - Muschio  PL - Polvere  CP - Cipria  CN - Canapa
- Le Acque di Cielo  OL - Oltremare  SM - Smeraldo  AL - Alga  CO - Corallo  NI - Ninfea  AM - Anemone



	<b>Product code</b> Artículo Article Artikel Артикул	<b>Net weight</b> (Kg) Peso neto Poids net Reingewicht вес нетто	<b>Finishes</b> Acabados Finitions Farbe Отделки	<b>Euro</b> Евро
 <p><b>Universal free flow drain in CHROME with ceramic lid</b> Válvula con desagüe libre CROMO con tapa en cerámica Bonde à écoulement libre CROMO avec clapet en céramique Freie Ablaufgarnitur CHROM mit Keramikstopfen Самотечный донный клапан в отделке CROMO с пробкой из керамики</p>	PILSL(X)*	0,40	 <b>Gloss White</b>	<b>91,00</b>
			 <b>N - Black</b>	<b>109,00</b>
			 <b>Le Terre di Cielo</b>	<b>133,00</b>
			 <b>Le Pietre</b>	<b>141,00</b>
			 <b>Le Acque di Cielo</b>	<b>133,00</b>
 <p><b>Universal free flow drain in BLACK MATT with ceramic lid</b> Válvula con desagüe libre NEGRO MATE con tapa en cerámica Bonde à écoulement libre NERO MATT avec clapet en céramique Freie Ablaufgarnitur MATT SCHWARZ mit Keramikstopfen Самотечный донный клапан в отделке NERO MATT с пробкой из керамики</p>	PILSLNM(X)*	0,40	 <b>Gloss White</b>	<b>115,00</b>
			 <b>N - Black</b>	<b>152,00</b>
			 <b>Le Terre di Cielo</b>	<b>161,00</b>
			 <b>Le Pietre</b>	<b>177,00</b>
			 <b>Le Acque di Cielo</b>	<b>161,00</b>
 <p><b>Universal free flow drain in CEMENTO with ceramic lid</b> Válvula con desagüe libre CEMENTO con tapa en cerámica Bonde à écoulement libre CEMENTO avec clapet en céramique Freie Ablaufgarnitur CEMENTO mit Keramikstopfen Самотечный донный клапан в отделке CEMENTO с пробкой из керамики</p>	PILSLCM(X)*	0,40	 <b>Gloss White</b>	<b>115,00</b>
			 <b>N - Black</b>	<b>152,00</b>
			 <b>Le Terre di Cielo</b>	<b>161,00</b>
			 <b>Le Pietre</b>	<b>177,00</b>
			 <b>Le Acque di Cielo</b>	<b>161,00</b>
 <p><b>Universal free flow drain in BRONZE with ceramic lid</b> Válvula con desagüe libre BRONCE con tapa en cerámica Bonde à écoulement libre BRONZO avec clapet en céramique Freie Ablaufgarnitur BRONZE mit Keramikstopfen Самотечный донный клапан в отделке BRONZO с пробкой из керамики</p>	PILSLBR(X)*	0,40	 <b>Gloss White</b>	<b>129,00</b>
			 <b>N - Black</b>	<b>163,00</b>
			 <b>Le Terre di Cielo</b>	<b>174,00</b>
			 <b>Le Pietre</b>	<b>177,00</b>
			 <b>Le Acque di Cielo</b>	<b>174,00</b>

 <p><b>Ceramic plug for PIL01 drain</b> Ceramic plug for PIL01 drain Tapon de cerámica para válvula PIL01 Bouchon en céramique pour bonde PIL01 Keramikstopfen für Ablaufgarnitur PIL01 Накладка из керамики на донный клапан PIL01</p>	COPIL(X)*	0,13	 <b>Gloss White</b>	<b>48,00</b>
			 <b>Le Terre di Cielo</b>	<b>72,00</b>
			 <b>Le Acque di Cielo</b>	<b>72,00</b>

Le Terre di Cielo  TL - Talco  PM - Pomice  BR - Brina  BA - Basalto  LV - Lavagna  CM - Cemento  FN - Fango  CA - Cacao







 AN - Arenaria  AV - Avena  LN - Lino  AG - Agave  MU - Muschio  PL - Polvere  CP - Cipria  CN - Canapa

Le Acque di Cielo  OL - Oltremare  SM - Smeraldo  AL - Alga  CO - Corallo  NI - Ninfea  AM - Anemone

	<b>Product code</b> Artículo Article Artikel Артикул	<b>Net weight</b> (Kg) Peso neto Poids net Reingewicht вес нетто	<b>Finishes</b> Acabados Finitions Farbe Отделки	<b>Euro</b> Евро
 <p><b>Siphon for freestanding washbasin</b>                      Sifon para lavabo freestanding                      Siphon pour lavabo freestanding                      Siphon für Säulewaschbecken Freestanding                      Сифон для отдельностоящей раковины</p>	SHFRSI	0,30		<b>58,00</b>
 <p><b>Shower tray siphon with chrome cover</b>                      Valvula cromada para plato e ducha                      Bonde de douche chromée pour la gamme                      Duschwannen Ablauf verchromt                      Донный клапан для душевого поддона, хром</p>	SIF90	0,25	 <b>Chrome</b>	<b>48,00</b>

## flow reducer



 <p><b>Flow reducer</b>                      Réducteur de portée                      Durchflussreduzierer                      Редуктор напора</p>	RP	0,08		<b>8,00</b>
---	----	------	--	-------------

	<b>Product code</b> Artículo Article Artikel Артикул	<b>Net weight</b> (Kg) Peso neto Poids net Reingewicht вес нетто	<b>Finishes</b> Acabados Finitions Farbe Отделки	<b>Euro</b> Евро
 <p><b>Technical curve “floor trap” for toilet</b>                      Curva técnica “salida vertical” para inodoro                      Courbe technique à S pour cuvette avec sortie au sol                      WC-Ablaufbogen “S”                      Колено “S”- образное для унитазов, регулируемое</p>	CSB	0,40		18,00
 <p><b>Straight pan connector for wall trap</b>                      Anclaje a pared para inodoro                      Pipe pour sortie horizontale                      WC-Anschlussstutzen für Abgang waagerecht                      Фитинг для выпуска в стену для унитазов</p>	RPB	0,35		15,00
 <p><b>90° technical curve</b>                      Curva de técnica a noventa grado                      Pipe d'évacuation à 90°                      WC-Aublaufbogen 90 Grad                      Колено 90° регулируемое</p>	CSR90	0,75		19,00
 <p><b>Pipe fitting with fixing bracket</b>                      Curva con estribos                      Pipe d'évacuation avec étrier de fixation                      WC-Aublaufbogen mit Halterung                      Колено с крепежом</p>	CSBST	0,50		21,00
 <p><b>PVC pipe for adjustable water outlet WC</b>                      Curva técnica para inodoro con salida a distancia especial                      Courbe technique pour vase avec raccord décharge                      Technischer Bogen zum WC mit einstellbaren Ablauf                      Колено для унитаза со сливом в пол</p>	CSTR	0,75		41,00
 <p><b>Eccentric pipe for water outlet up to ± 1,5 cm</b>                      Tubo buque trasero excéntrico máximo ± 1,5 cm                      Pipe de raccordement d'évacuation WC excentré max ± 1,50 cm                      WC-Abgangstutzen mit Excenter (max ± 1,5 cm)                      Патрубок для унитаза эксцентрический макс. ± 1,5 cm</p>	RSE	0,10		15,00









## fixing system for washbasin







# cielo





	<b>Product code</b> Artículo Article Artikel Артикул	<b>Net weight</b> (Kg) Peso neto Poids net Reingewicht вес нетто	<b>Finishes</b> Acabados Finitions Farbe Отделки	<b>Euro</b> Евро
 <p><b>Fixing system for wall-hung washbasin</b>                      Fijaciones para lavabo suspendido                      Fixations pour lavabo suspendu                      Befestigungen für waschtische hängender                      Крепежи для раковин подвесная</p>	54/A	0,10		7,00
 <p><b>Fixing system for Enjoy undercounter washbasin</b>                      Fijaciones para lavabo bajo encimera                      Fixations pour vasque à encastrer par dessous                      Befestigungen für Unterbaubecken Enjoy                      Крепления для раковины для установки под столешницу</p>	FISP	0,40		17,00







## fixing system for sanitary





 <p><b>Fixing system for back to wall wc/bidet</b>                      Fijaciones para Inodoro/Bidet a suelo                      Fixations au sol pour Cuvette/Bidet au sol                      Stand -WC Befestigung                      Крепежи напольные для напольных унитазов/биде</p>	52L	0,10		9,00
 <p><b>Fixed system for suspended wc/bidet</b>                      Fijaciones para inodoro/bidet suspendidos                      Fixage au mur pour cuvette/bidet suspendus                      Befestigungskit für Wand-WC/Bidet                      Настенная монтажная рама для подвесных унитазов</p>	508	2,00		39,00
<p><b>Universal fixing system for wall-hung wc/bidet</b>                      Fijación universal inodoro/bidet suspendidos                      Fixations universel pour cuvette/bidet suspendus                      Rasche Befestigungen für Wand-WC/Bidet                      Упрощенные крепежи для подвесных унитазов/биде</p>	FIUS			32,00

	<b>Product code</b> Artículo Article Artikel Артикул	<b>Net weight</b> (kg) Peso neto Poids net Reingewicht вес нетто	<b>Finishes</b> Acabados Finitions Farbe Отделки	<b>Euro</b> Евро
<p><b>Chrome hinges kit for Catino seat cover</b></p> <p>Bisagras cromado para asiento Catino Charnières cromées pour abattant Catino Scharniere verchromt für WC-Sitz Catino Комплект хромированных петель для сиденья Catino</p>	CACE	0,50	 <b>Chrome</b>	<b>32,00</b>
<p><b>Soft close chrome quick release hinges kit for Catino</b></p> <p>Bisagras cromado para asiento Catino amortiguado Charnières cromées pour abattant Catino avec frein de chute Scharniere mit Softclose-Funktion für WC-Sitz Catino Комплект хромированных петель для сиденья Catino с плавным опусканием</p>	CACEF	0,53	 <b>Chrome</b>	<b>65,00</b>
<p><b>Chrome hinges kit for Mare seat cover</b></p> <p>Bisagras cromado para asiento Mare Charnières cromées pour abattant Mare Scharniere verchromt für WC-Sitz Mare Комплект хромированных петель для сиденья Mare</p>	MRCE	0,67	 <b>Chrome</b>	<b>32,00</b>
<p><b>Soft close chrome quick release hinges kit for Mare</b></p> <p>Bisagras cromado para asiento Mare amortiguado Charnières cromées pour abattant Mare avec frein de chute Scharniere mit Softclose-Funktion für WC-Sitz Mare Комплект хромированных петель для сиденья Mare с плавным опусканием</p>	MRCEF	0,70	 <b>Chrome</b>	<b>65,00</b>

	<b>Product code</b> Artículo Article Artikel Артикул	<b>Net weight</b> (Kg) Peso neto Poids net Reingewicht вес нетто	<b>Finishes</b> Acabados Finitions Farbe Отделки	<b>Euro</b> Евро
<p><b>Chrome hinges kit for Smile seat cover</b></p> <p>Bisagras cromado para asiento Smile Charnières cromées pour abattant Smile Scharniere verchromt für WC-Sitz Smile Комплект хромированных петель для сиденья Smile</p>	SMCE	0,18	 <b>Chrome</b>	<b>32,00</b>
<p><b>Soft close chrome hinges kit for Smile seat cover</b></p> <p>Bisagras cromado para asiento Smile NEW amortiguado Charnières cromées pour abattant Smile avec frein de chute Scharniere mit Softclose-Funktion für WC-Sitz Smile Комплект хромированных петель для сиденья Smile с плавным опусканием</p>	SMCEF	0,20	 <b>Chrome</b>	<b>52,00</b>
<p><b>Soft close chrome quick release hinges kit for Smile</b></p> <p>Bisagras cromado para asiento Smile Charnières cromées pour abattant Smile avec frein de chute Scharniere mit Softclose-Funktion für WC-Sitz Smile Комплект хромированных петель для сиденья Smile с плавным опусканием</p>	SMCEFS	0,20	 <b>Chrome</b>	<b>52,00</b>
<p><b>Soft close chrome quick release hinges kit for Smile NEW</b></p> <p>Bisagras cromado para asiento Smile NEW Charnières cromées pour abattant Smile NEW avec frein de chute Scharniere mit Softclose-Funktion für WC-Sitz Smile NEW Комплект хромированных петель для сиденья Smile NEW с плавным опусканием</p>	SMNWCES	0,20	 <b>Chrome</b>	<b>52,00</b>
<p><b>Chrome hinges kit for Shui seat cover</b></p> <p>Bisagras cromado para asiento Shui Charnières cromées pour abattant Shui Scharniere verchromt für WC-Sitz Shui Комплект хромированных петель для сиденья Shui Chrome</p>	SHCE	0,18	 <b>Chrome</b>	<b>32,00</b>
<p><b>Soft close chrome hinges kit for Shui</b></p> <p>Bisagras cromado para asiento Shui amortiguado Charnières cromées pour abattant Shui avec frein de chute Scharniere mit Softclose-Funktion für WC-Sitz Shui Комплект хромированных петель для сиденья Shui с плавным опусканием</p>	SHCEF	0,20	 <b>Chrome</b>	<b>52,00</b>
<p><b>Chrome hinges kit for Shui Comfort seat cover</b></p> <p>Bisagras cromado para asiento Shui Comfort Charnières cromées pour abattant Shui Comfort Scharniere verchromt für WC-Sitz Shui Comfort Комплект хромированных петель для сиденья Shui Comfort</p>	SHCOCE	0,18	 <b>Chrome</b>	<b>32,00</b>

	<b>Product code</b> Artículo Article Artikel Артикул	<b>Net weight</b> (Kg) Peso neto Poids net Reingewicht вес нетто	<b>Finishes</b> Acabados Finitions Farbe Отделки	<b>Euro</b> Евро
<p><b>Soft close chrome quick release hinges kit for Shui Comfort</b></p> <p>Bisagras cromado para asiento Shui Comfort amortiguado Charnières cromées pour abattant Shui Comfort avec frein de chute Scharniere mit Softclose-Funktion für WC-Sitz Shui Comfort Комплект хромированных петель для сиденья Shui Comfort с плавным опусканием</p>	SHCOCEF	0,20	 <b>Chrome</b>	<b>65,00</b>
<p><b>Chrome hinges kit for Opera seat cover</b></p> <p>Bisagras cromado para asiento Opera Charnières cromées pour abattant Opera Scharniere verchromt für WC-Sitz Opera Комплект хромированных петель для сиденья Opera</p>	OPCE	0,18	 <b>Chrome</b>	<b>32,00</b>
<p><b>Soft close chrome hinges kit for Opera seat cover</b></p> <p>Bisagras cromado para asiento Opera amortiguado Charnières cromées pour abattant Opera avec frein de chute Scharniere mit Softclose-Funktion für WC-Sitz Opera Комплект хромированных петель для сиденья Opera с плавным опусканием</p>	OPCEF	0,20	 <b>Chrome</b>	<b>52,00</b>
<p><b>Chrome hinges kit for Le Giare seat cover</b></p> <p>Bisagras cromado para asiento Le Giare Charnières cromées pour abattant Le Giare Scharniere verchromt für WC-Sitz Le Giare Комплект хромированных петель для сиденья Le Giare</p>	LGCE	0,18	 <b>Chrome</b>	<b>32,00</b>
<p><b>Soft close chrome hinges kit for Le Giare seat cover</b></p> <p>Bisagras cromado para asiento Le Giare amortiguado Charnières cromées pour abattant Le Giare avec frein de chute Scharniere mit Softclose-Funktion für WC-Sitz Shui Комплект хромированных петель для сиденья Le Giare с плавным опусканием</p>	LGCEF	0,20	 <b>Chrome</b>	<b>52,00</b>

	<b>Product code</b> Artículo Article Artikel Артикул	<b>Net weight</b> (Kg) Peso neto Poids net Reingewicht вес нетто	<b>Finishes</b> Acabados Finitions Farbe Отделки	<b>Euro</b> Евро
<p><b>Chrome hinges kit for Fluid seat cover</b> Bisagras cromado para asiento Fluid Charnières cromées pour abattant Fluid Scharniere verchromt für WC-Sitz Fluid Комплект хромированных петель для сиденья Fluid</p>	FLCE	0,18	 <b>Chrome</b>	<b>32,00</b>
<p><b>Soft close chrome hinges kit for Fluid seat cover</b> Bisagras cromado para asiento Fluid amortiguado Charnières cromées pour abattant Fluid avec frein de chute Scharniere mit Softclose-Funktion für WC-Sitz Fluid Комплект хромированных петель для сиденья Fluid с плавным опусканием</p>	FLCEF	0,20	 <b>Chrome</b>	<b>52,00</b>
<p><b>Chrome hinges kit for Enjoy seat cover</b> Bisagras cromado para asiento Enjoy Charnières cromées pour abattant Enjoy Scharniere verchromt für WC-Sitz Enjoy Комплект хромированных петель для сиденья Enjoy</p>	EJCE	0,18	 <b>Chrome</b>	<b>32,00</b>
<p><b>Soft close chrome hinges kit for Enjoy seat cover</b> Bisagras cromado para asiento Enjoy amortiguado Charnières cromées pour abattant Enjoy avec frein de chute Scharniere mit Softclose-Funktion für WC-Sitz Enjoy Комплект хромированных петель для сиденья Enjoy с плавным опусканием</p>	EJCEF	0,20	 <b>Chrome</b>	<b>52,00</b>
<p><b>Soft close chrome quick release hinges kit for Enjoy NEW</b> Bisagras cromado para asiento Enjoy NEW Charnières cromées pour abattant Enjoy NEW avec frein de chute Scharniere mit Softclose-Funktion für WC-Sitz Enjoy NEW Комплект хромированных петель для сиденья Enjoy NEW с плавным опусканием</p>	EJNWCES	0,20	 <b>Chrome</b>	<b>52,00</b>
<p><b>Chrome quick release hinges kit for Era seat cover</b> Bisagras cromado para asiento Era Charnières cromées pour abattant Era Scharniere verchromt für WC-Sitz Era Комплект хромированных петель для сиденья Era</p>	ERCE	0,18	 <b>Chrome</b>	<b>32,00</b>
<p><b>Soft close chrome quick release hinges kit for Era seat cover</b> Bisagras cromado para asiento Era amortiguado Charnières cromées pour abattant Era avec frein de chute Scharniere mit Softclose-Funktion für WC-Sitz Shui Comfort Комплект хромированных петель для сиденья Era с плавным опусканием</p>	ERCEF	0,20	 <b>Chrome</b>	<b>52,00</b>

	<b>Product code</b> Artículo Article Artikel Артикул	<b>Net weight</b> (Kg) Peso neto Poids net Reingewicht вес нетто	<b>Finishes</b> Acabados Finitions Farbe Отделки	<b>Euro</b> Евро
<b>Complete hinge kit with fixtures for Enjoy / Smile toilet seat covers</b>  Kit bisagras completas de fijaciones para tapa Enjoy/Smile Комплект петель с креплениями для сидений Enjoy/Smile Kit de charnières avec fixations pour abattants de WC Enjoy/Smile Scharnierset mit Befestigungselementen für WC-Deckel Enjoy/Smile	EJSMCEFIX	0,14	 <b>Chrome and White</b>	<b>44,00</b>
<b>Complete hinge kit with fixtures for Enjoy / Smile soft close toilet seat covers</b>  Kit bisagras completas de fijaciones para tapa Enjoy/Smile amortiguada Комплект петель с креплениями для сидений с плавным опусканием Enjoy/Smile Kit de charnières avec fixations pour abattants de WC soft close Enjoy/Smile Scharnierset mit Befestigungselementen für WC-Deckel Enjoy/Smile mit Absenkautomatik	EJSMCEFFIX	0,14	 <b>Chrome and White</b>	<b>72,00</b>
<b>Quick release hinges for Smile / Enjoy</b>  Kit bisagras para tapa Enjoy/Smile Комплект петель для сидений Enjoy/Smile Kit de charnières pour abattants de WC Enjoy/Smile Scharnierset für WC-Deckel Enjoy/Smile mit Absenkautomatik	EJSMCE	0,03	 <b>White</b>	<b>23,00</b>
<b>Soft close quick release hinges for Smile / Enjoy</b>  Kit bisagras para tapa Enjoy/Smile amortiguada Комплект петель для сидений с плавным опусканием Enjoy/Smile Kit de charnières pour abattants de WC soft close Enjoy/Smile Scharnierset für WC-Deckel Enjoy/Smile mit Absenkautomatik	EJSMCEF	0,05	 <b>White</b>	<b>52,00</b>
<b>Enjoy / Smile fixtures</b>  Fijaciones Enjoy/Smile Крепления Enjoy/Smile Fixations Enjoy/Smile Befestigungselemente Enjoy/Smile	EJSMFCPV	0,09	 <b>Chrome</b>	<b>31,00</b>
<b>Enjoy / Smile bumpers</b>  Parachoques Enjoy/Smile Амортизаторы для сидений Enjoy/Smile Pare-chocs Enjoy/Smile Puffer Enjoy/Smile	EJSMPCPV	0,02		<b>12,00</b>





# Discontinued

















Available until sell-out of goods







	Size (cm)	Product code	Net weight(Kg)	Finishes	Euro	Pz.	Pz.
	Medidas Dimensions Maße Размеры	Artículo Article Artikel Артикул	Peso neto Poids net Reingewicht вес нетто	Acabados Finitions Farbe Отделки	Евро	шт. pallet Italia	шт. pallet Cont.
 <p><b>Pedestal for Amedeo Ovale washbasin with siphon</b> Columna Amedeo para lavabo Ovale con sifon Colonne Amedeo pour lavabo Ovale avec siphon Amedeo Säule für rundes Waschbecken Ovale Пьедестал Amedeo для раковины Ovale, в комплекте с сифоном</p>	65 x 45 x 87,5 h	AMCOLO(x)*	42,50	 <b>Gloss White</b>  <b>*X = N - Gloss Black</b>  <b>Le Terre di Cielo</b>	1286,00 1726,00 2063,00	2	4
 <p><b>Amedeo Ovale countertop or recessed installation washbasin</b> Lavabo Amedeo Ovale de apoyo o encastre Vasque Amedeo Ovale à poser ou à encastrer Amedeo Ovale Aufsatz- oder einbauwaschbecken Раковина Amedeo Ovale накладная или встраиваемая</p>	65 x 45 x 17 h	AMLA65(x)*	11,50	 <b>Gloss White</b>  <b>*X = N - Gloss Black</b>  <b>Le Terre di Cielo</b>	698,00 901,00 1125,00	16	32
 <p><b>Ceramic Plate Amedeo Ovale washbasin</b> Lámina cubre válvula cerámica para Lavabo Amedeo Ovale \ Cache-écoulement en céramique pour lavabo Amedeo Ovale Keramik-Abdeckplatte für Waschbecken Amedeo Ovale \ Накладка керамическая на донный клапан для раковины Amedeo Ovale</p>	30 x 50	AMPILO(x)*	3,00	 <b>Gloss White</b>  <b>*X = N - Gloss Black</b>  <b>Le Terre di Cielo</b>	152,00 215,00 250,00		
 <p><b>Pedestal for Amedeo Tondo washbasin with siphon</b> Columna Amedeo para lavabo Tondo con sifon Colonne Amedeo pour lavabo Tondo avec siphon Amedeo Säule für rundes Waschbecken Tondo Пьедестал Amedeo для раковины Tondo, в комплекте с сифоном</p>	ø45 x 87,5 h	AMCOLT(x)*	23,00	 <b>Gloss White</b>  <b>*X = N - Gloss Black</b>  <b>Le Terre di Cielo</b>	1103,00 1487,00 1769,00	2	4
 <p><b>Amedeo Tondo countertop or recessed installation washbasin</b> Lavabo Amedeo Tondo de apoyo o encastre Vasque Amedeo Tondo à poser ou à encastrer Amedeo Tondo Aufsatz- oder Einbauwaschbecken Раковина Amedeo Tondo накладная или встраиваемая</p>	ø45 x 17 h	AMLA45(x)*	8,00	 <b>Gloss White</b>  <b>*X = N - Gloss Black</b>  <b>Le Terre di Cielo</b>	566,00 750,00 913,00	20	40
 <p><b>Ceramic Plate Amedeo Tondo washbasin</b> Lámina cubre válvula cerámica para lavabo Amedeo Tondo \ Cache-écoulement en céramique pour lavabo Amedeo Tondo \ Keramik- Abdeckplatte für rundes Waschbecken Amedeo Tondo \ Накладка керамическая на донный клапан для раковины Amedeo Tondo</p>	ø31	AMPILT(x)*	1,50	 <b>Gloss White</b>  <b>*X = N - Gloss Black</b>  <b>Le Terre di Cielo</b>	126,00 177,00 206,00		
<b>Fixing system for Amedeo Ovale Pedestal (mandatory with AMCOLO)</b> Fijaciones para columna Amedeo Ovale (obligatorio con AMCOLO) / Fixations pour colonne Amedeo Ovale (nécessaire avec AMCOLO) / Halterung für Säule Amedeo Ovale (geboten mit AMCOLO) / Крепежи для пьедестала Amedeo Ovale (обязательный с AMCOLO)		AMFIO	1,90		76,00		
<b>Fixing system for Amedeo Tondo Pedestal (mandatory with AMCOLT)</b> Fijaciones para columna Amedeo Tondo (obligatorio con AMCOLT) / Fixations pour colonne Amedeo Tondo (nécessaire avec AMCOLT) / Halterung für Amedeo Tondo Säule (geboten mit AMCOLT) / Крепежи для пьедестала Amedeo Tondo (обязательный с AMCOLT)		AMFIT	1,70		76,00		

## Technical symbols legend





Simbolos técnicos clave / Légende symboles techniques / Technische Zeichenerklärung / Перечень технических символов

 <p><b>all sides are enamelled</b> con todos los lados esmaltados avec tous les côtés émaillés alle Seiten glasiert все стороны покрыты эмалью</p>	 <p><b>room centre freestanding installation</b> instalación freestanding centro habitación installation autoportante centre pièce freistehende Montage in der Raummitte свободностоящая установка по центру комнаты</p>	 <p><b>with technical joint or siphon</b> completo de curva/sifon fourni avec raccord courbé / siphon komplett mit Rohrbogen/ Siphon в комплекте с коленом / сифоном</p>	 <p><b>no tap holes</b> sin agujero para grifo sans orifice robinet ohne Hahnloch без отверстия под смеситель</p>	 <p><b>without overflow</b> sin rebosadero sans trop-plein ohne Überlauf без слива-перелива</p>
 <p><b>on top installation</b> instalación de apoyo installation à partir du plan Montage auf Platte установка на столешницу</p>	 <p><b>semirecessed installation</b> instalación semiempotrada installation semi encastrée Halbeinbaumontage подвесная установка</p>	 <p><b>on pedestal/half pedestal installation</b> instalación en columna/semicolumna Montage auf Säule/Halbsäule установка на пьедестал</p>		

Le Terre di Cielo	 TL - Talco	 PM - Pomice	 BR - Brina	 BA - Basalto	 LV - Lavagna	 CM - Cemento	 FN - Fango	 CA - Cacao
	 AN - Arenaria	 AV - Avena	 LN - Lino	 AG - Agave	 MU - Muschio	 PL - Polvere	 CP - Cipria	 CN - Canapa

	Size (cm)	Product code	Net weight(Kg)	Finishes	Euro	Pz.	Pz.
	Medidas Dimensions Maße Размеры	Artículo Article Artikel Артикул	Peso neto Poids net Reingewicht вес нетто	Acabados Finitions Farbe Отделки	Euro	шт. pallet Italia	шт. pallet Cont.
 <p><b>Back to wall one hole bidet</b> Bidé a suelo monoagujero Bidet monotrou Stand-Bidet einloch Биде напольное с одним отверстием под смеситель</p>	37 x 55 x 42,5 h	LGBI	26,30	 <b>Gloss White</b>	<b>491,00</b>	15	20
 <p><b>Wall-hung one hole bidet with fixing kit</b> Bidé suspendido monoagujero completo con fijaciones / Bidet suspendu monotrou avec fixation / Wand-Bidet einloch mit Befestigungsset / Биде подвесное с одним отверстием под смеситель, в комплекте с крепежами</p>	37 x 55 x 33,5 h	LGBS(X)*	18,25	 <b>Gloss White</b>  <b>*X = N - Gloss Black</b>  <b>*X = TL - Talco</b>  <b>Le Terre di Cielo*</b>	<b>605,00</b> <b>898,00</b> <b>898,00</b> <b>965,00</b>	18	18

## Enjoy

	Size (cm)	Product code	Net weight(Kg)	Finishes	Euro	Pz.	Pz.
	Medidas Dimensions Maße Размеры	Artículo Article Artikel Артикул	Peso neto Poids net Reingewicht вес нетто	Acabados Finitions Farbe Отделки	Euro	шт. pallet Italia	шт. pallet Cont.
 <p><b>Wall-hung or on top washbasin</b> Lavabo suspendido o de apoyo Lavabo suspendu ou à poser Waschtisch hängender oder Aufsatz Installation Раковина с одним отверстием под смеситель, подвесная или накладная установка</p>	140 x 48 x 13 h	EJLS140(X)*	39,10	 <b>Gloss White</b>  <b>Le Terre di Cielo</b>	<b>1128,00</b> <b>1669,00</b>	10	10
	120 x 48 x 13 h	EJLS120(X)*	36,05	 <b>Gloss White</b>  <b>Le Terre di Cielo</b>	<b>898,00</b> <b>1374,00</b>	10	20
<p><b>The washbasin is recommended for wall hung installation. For on top installation customers are advised to the require the "RETTIFICA" option.</b> Se recomienda la instalación del lavabo suspendido. Para instalaciones de apoyo se aconseja usar la opción "RETTIFICA". / La vasque est recommandée pour l'installation suspendu. Pour l'installation à poser on conseille l'option "RETTIFICA". / Es empfiehlt sich, das Waschbecken hängend zu installieren. Bei Aufsatzmontage bitte die Option "RETTIFICA" anfragen. / Данная раковина предназначена для подвесной установки. При установке на столешницу рекомендуется запросить опцию "RETTIFICA".</p>					<b>10,00</b>		
		<b>RETTIFICA GRINDING РЕКТИФИКАЦИЯ</b>					

### Technical symbols legend

Simbolos técnicos clave /  
Légende symboles techniques  
Technische Zeichenerklärung  
Перечень технических символов

 **one tap hole**  
con 1 agujero monotrou  
1-Loch  
одно отверстие под смеситель

 **with overflow**  
con rebosadero  
avec trop-plein  
mit Überlauf  
с переливом







 **back to wall installation**  
instalación a suelo  
installation à terre  
bodenstehende Montage  
напольная установка

 **with fixing parts**  
fijaciones incluidas  
fixations incluses  
inklusive Befestigungen  
в комплекте с крепежами











 **Combifix compatibility**  
compatible Combifix  
mit Combifix kompatibel  
совместим с combifix

\* Terre di Cielo finishes available for bidet /  
Acabados Terre di Cielo disponibles para bidet / Finitions  
Terre di Cielo disponibles pour bidet | Für das Bidet  
erhältliche Ausführungen Terre di Cielo | отделку Terre di  
Cielo доступны для биде

 **TL - Talco**  **PM - Pomice**  **BR - Brina**  **AN - Arenaria**  **AV - Avena**  **CM - Cemento**  **BA - Basalto**  **LV - Lavagna**

 <b>Wall-hung washbasin</b> Lavabo suspendido \ Lavabo suspendu \ Hängender Waschbecken \ Раковина подвесной	Size (cm)	Product code	Net weight (kg)	Finishes	Euro	Pz.	Pz.
	Medidas Dimensions Maße Размеры	Artículo Article Artikel Артикул	Peso neto Poids net Reingewicht вес нетто	Acabados Finitions Farbe Отделки	Евро	шт. pallet Italia	шт. pallet Cont.
 <b>Frontal towel-rail for wall-hung washbasin</b> Barra para toallas frontal para lavabo suspendido \ Porte-serviette frontale pour lavabo suspendu \ Handtuchhalter Installation unten für Hängender Waschbecken \ Полотенцедержатель нижний фронтальный для Раковина подвесной	100 x 48 x 15 h	FLLS100(X)*	23,30	 <b>Gloss White</b>	<b>680,00</b>	14	21
	80 x 48 x 15 h	FLLS80(X)*	22,05	 <b>Gloss White</b>	<b>579,00</b>	16	28
		FLPLS100	0,55	 <b>Chrome</b>	<b>181,00</b>		
		FLPLS80	0,45	 <b>Chrome</b>	<b>177,00</b>		

## Urinals

 <b>*Ball wall-hung Urinal</b> Urinario suspendido Ball Urinoir suspendu Ball Wand-Urinal Ball писсуар подвесной Ball *kit Ball pg. 547	Size (cm)	Product code	Net weight (kg)	Finishes	Euro	Pz.	Pz.
	Medidas Dimensions Maße Размеры	Artículo Article Artikel Артикул	Peso neto Poids net Reingewicht вес нетто	Acabados Finitions Farbe Отделки	Евро	шт. pallet Italia	шт. pallet Cont.
 <b>Slot floor-mounted urinal</b> Urinario a suelo Slot Urinoir au sol Slot Stand-Urinal Slot писсуар напольный Slot	60 x 30 x 63 h	ORBL(X)*	23,80	 <b>Gloss White</b>  <b>*X = N - Gloss Black</b>  <b>Le Terre di Cielo</b>	<b>605,00</b> <b>889,00</b> <b>1064,00</b>	6	9
	30 x 23 x 147 h	ORSL(X)*	45,65	 <b>Gloss White</b>  <b>*X = N - Gloss Black</b>  <b>Le Terre di Cielo</b>	<b>968,00</b> <b>1434,00</b> <b>1653,00</b>	9	9
		ORKITS(X)*		 <b>*X = B - White</b>  <b>*X = C - Chrome</b>	<b>88,00</b> <b>91,00</b>		

### N.B. The flush mechanism is not included

 El kit no incluye el mecanismo de descarga / Le kit ne comprend pas le mécanisme de chasse d'eau /  
 Achtung: Der Spülmechanismus ist im Set nicht enthalten / Примечание: сливной механизм в комплект не входит

#### Technical symbols legend

Símbolos técnicos clave /  
 Légende symboles techniques /  
 Technische Zeichenerklärung /  
 Перечень технических символов



**one side is unglazed**  
 con un lado sin esmaltar  
 avec un côté non émaillé  
 eine Seite unglasiert  
 одна сторона не покрыта эмалью



**with 1 hole prepared 3 holes**  
 avec un trou prédisposition à trois trous  
 mit 1-Loch auf 3-Loch durchschlagbar  
 одно отверстие с возможностью  
 выполнения трех отверстий



**with overflow**  
 con rebosadero  
 avec trop-plein  
 mit Überlauf  
 с переливом



**on top installation**  
 instalación de apoyo  
 installation à partir du plan  
 Montage auf Platte  
 установка на столешницу



**with fixing parts**  
 fijaciones incluidas  
 fixations incluses  
 inklusive Befestigungen  
 в комплекте с крепежами



**back to wall freestanding installation**  
 instalación freestanding a pared / installation  
 autoportante murale / freistehende Montage  
 an der Wand / свободная установка  
 пристенная установка



**wall-hung installation**  
 instalación suspendida  
 installation suspendue  
 wandhängende Montage  
 подвесная установка

Le Terre di Cielo



TL - Talco



PM - Pomice



BR - Brina



BA - Basalto



LV - Lavagna



CM - Cemento



FN - Fango



CA - Cacao



AN - Arenaria



AV - Avena



LN - Lino



AG - Agave



MU - Muschio



PL - Polvere



CP - Cipria





CN - Canapa

	<b>Size (cm)</b> Medidas Dimensions Maße Размеры	<b>Product code</b> Artículo Article Artikel Артикул	<b>Net weight (Kg)</b> Peso neto Poids net Reingewicht вес нетто	<b>Finishes</b> Acabados Finitions Farbe Отделки	<b>Euro</b> Евро	<b>Pz.</b> шт. pallet Italia	<b>Pz.</b> шт. pallet Cont.
 <p><b>Wall-hung or on top washbasin</b>                      Lavabo suspendido o de apoyo \ Lavabo suspendu ou à poser \ Waschtisch hängender oder Aufsatz Installation                      Раковина с одним отверстием под смеситель, подвесная или накладная установка</p> <p><b>The washbasin is recommended for wall hung installation. For on top installation customers are advised to the require the "RETTIFICA" option.</b>                      Se recomienda la instalación del lavabo suspendido. Para instalaciones de apoyo se aconseja usar la opción "RETTIFICA".                      La vasque est recommandée pour l'installation suspendu. Pour l'installation à poser on conseille l'option "RETTIFICA".                      Es empfiehlt sich, das Waschbecken hängend zu installieren. Bei Aufsatzmontage bitte die Option "RETTIFICA" anfragen.                      Данная раковина предназначена для подвесной установки. При установке на столешницу рекомендуется запросить опцию "RETTIFICA".</p>	80 x 48,5 x 15 h	SHLS80(X)*	24,20	 <b>Gloss White</b>	461,00	14	25
	54 x 48,5 x 15 h	SHLS54(X)*	16,10	 <b>Gloss White</b>	291,00	20	34
		<b>RETTIFICA GRINDING РЕКТИФИКАЦИЯ</b>			10,00		
 <p><b>Half pedestal washbasin - on top installation /</b> Lavabo semi columna instalación de apoyo / Vasque demi-colonne à poser sur plan / Halbsäule Aufsatzwaschtisch / Раковина с полупьедесталом, накладная установка</p>	36 x 36 x 45 h	SHLAA(X)*	19,50	 <b>Gloss White</b>	1076,00	8	16
 <p><b>One hole half pedestal washbasin - wall-hung installation /</b> Lavabo monoagujero semi columna instalación suspendida / Vasque demicolonne suspendue monotrou / Halbsäule Hängewaschtisch für Einlocharmatur / Раковина с одним отверстием под смеситель, с полупьедесталом, подвесная установка</p>	36 x 46 x 45 h	SHLASR(X)*	19,50	 <b>Gloss White</b>	1076,00	8	16
<p><b>The washbasins SHLAS, SHLASR are recommended for wall hung installation. For on top installation customers are advised to the require the "RETTIFICA" option.</b>                      Se recomienda la instalación del lavabo suspendido. Para instalaciones de apoyo se aconseja usar la opción "RETTIFICA" (SHLA-SHLASR). \ La vasque SHLA-SHLASR est recommandée pour l'installation suspendu. Pour l'installation à poser on conseille l'option "RETTIFICA". \ Es empfiehlt sich, das Waschbecken hängend zu installieren. Bei Aufsatzmontage bitte die Option "RETTIFICA" anfragen (SHLA-SHLASR).                      Данная раковина предназначена для подвесной установки. При установке на столешницу рекомендуется запросить опцию "RETTIFICA" (SHLA-SHLASR).</p>		<b>RETTIFICA GRINDING РЕКТИФИКАЦИЯ</b>			10,00		

### Technical symbols legend

Símbolos técnicos clave | Légende symboles techniques | Technische Zeichenerklärung | Перечень технических символов

 **with overflow**  
 con rebosadero  
 avec trop-plein  
 mit Überlauf  
 с переливом

 **one side is unglazed**  
 con un lado sin esmaltar  
 avec un côté non émaillé  
 eine Seite unglasiert  
 одна сторона не покрыта эмалью











 **with 1 hole prepared 3 holes**  
 1 agujero predispuerto 3 agujeros  
 avec un trou prédisposition à trois trous  
 mit 1-Loch auf 3-Loch durchschlagbar  
 одно отверстие с возможностью выполнения трех отверстий

 **on top installation**  
 instalación de apoyo  
 installation à partir du plan  
 Montage auf Platte  
 установка на столешницу

 **wall-hung installation**  
 instalación suspendida  
 installation suspendue  
 wandhängende Montage  
 подвесная установка

 **with fixing parts**  
 fijaciones incluidas  
 fixations incluses  
 inklusive Befestigungen  
 в комплекте с крепежами



	<b>Size (cm)</b> Medidas Dimensions Maße Размеры	<b>Product code</b> Artículo Article Artikel Артикул	<b>Net weight(Kg)</b> Peso neto Poids net Reingewicht вес нетто	<b>Finishes</b> Acabados Finitions Farbe Отделки	<b>Euro</b> Евро	<b>Pz.</b> шт. pallet Italia	<b>Pz.</b> шт. pallet Cont.
 <p><b>Square washbasin</b>            Lavabo Square            Waschbecken Square            Раковина Square</p>	100 x 48 x 16 h	SMLA100(X)*	28,55	 <b>Gloss White</b>	<b>597,00</b>	12	20
<p><b>It would be advisable to have a wall-hung installation of the washbasin. For the installation of an "on top" or semi-recessed basin we recommend to request the RETTIFICA option, specifying the type of installation.</b>            Se aconseja para este lavabo la instalación suspendida. Para la instalación de apoyo o semi-empotrado se aconseja la opción "RETTIFICA", especificando el tipo de instalación / Le lavabo est conseillé pour une installation suspendue. Pour une installation posée ou encastrée sur plan nous conseillons de requérir l'option "RECTIFICATION", en précisant le type d'installation / Es empfiehlt sich, das Waschbecken hängend zu installieren. Bei Aufsatz oder Halbeinbaumontage bitte die Option "RETTIFICA" anfragen. Bei der Bestellung ,bitte, Montagesorte auch angeben. / Данная раковина предназначена для подвесной установки. При установке на столешницу рекомендуется запросить опцию "RETTIFICA".</p>	48 x 48 x 16 h	SMLA48(X)*	15,85	 <b>Gloss White</b>	<b>300,00</b>	28	56
 <p><b>Towel-rail lateral upper installation right/left for Square 100/48 washbasin</b>            Barra para toallas instalación lateral superior derecha/izquierda para lavabos Square 100/48 Porte-serviette installation supérieure latérale droite/gauche pour lavabo Square 100/48 / Handtuchhalter Installation seitlich oben rechts/links für Aufsatzbecken Square 100/48 / Полотенцедержатель верхний боковой, правосторонний/левосторонний для Square 100/48</p>	46 x 8 h	SMPSS48	0,35	 <b>Chrome</b>	<b>124,00</b>		
 <p><b>Towel-rail lower installation, frontal (for 48 washbasin) or lateral (for 100/48 washbasins)</b>            Barra para toallas frontal (para lavabo 48) o lateral (para lavabos 100/48) instalación inferior / Porte-serviette installation inferieure frontal (pour lavabo 48) ou latéral (pour lavabo 100/48) / Handtuchhalter Installation vorn unten (für Aufsatzbecken 48) oder seitlich unten (für Aufsatzbecken 100/48) / Полотенцедержатель нижний, установка как фронтальная (для Square 48), так и боковая (для Square 100)</p>	46 x 8 h	SMPSI48	0,35	 <b>Chrome</b>	<b>124,00</b>		
 <p><b>Towel-rail lower installation for 100 washbasin</b>            Barra para toallas instalación inferior para lavabo 100            Porte serviette installation sous meuble pour lavabo 100            Handtuchhalter montage unter dem möbel für Aufsatzbecken 100            Полотенцедержатель нижний для Square 100</p>	98 x 8 h	SMPSI100	0,53	 <b>Chrome</b>	<b>163,00</b>		

### Technical symbols legend

Simbolos técnicos clave / Légende symboles techniques / Technische Zeichenerklärung / Перечень технических символов

**one side is unglazed**  
 con un lado sin esmaltar  
 avec un côté non émaillé  
 eine Seite unglasiert  
 одна сторона не покрыта эмалью

**with 1 hole prepared 3 holes**  
 avec un trou prédisposition à trois trous  
 mit 1-Loch auf 3-Loch durchschlagbar  
 одно отверстие с возможностью выполнения трех отверстий









**with overflow**  
 con rebosadero  
 avec trop-plein  
 mit Überlauf  
 с переливом

**on top installation**  
 instalación de apoyo  
 installation à partir du plan  
 Montage auf Platte  
 установка на столешницу

**wall-hung installation**  
 instalación suspendida  
 installation suspendue  
 wandhängende Montage  
 подвесная установка

**semirecessed installation**  
 instalación semiempotrada  
 installation semi encastrée  
 Halbeinbaumontage  
 подвесная установка

**with fixing parts**  
 fijaciones incluidas  
 fixations incluses  
 inklusive Befestigungen  
 в комплекте с крепежами

 	Size (cm)	Product code	Net weight (Kg)	Finishes	Euro	Pz.	Pz.
	Medidas Dimensions Maße Размеры	Artículo Article Artikel Артикул	Peso neto Poids net Reingewicht вес нетто	Acabados Finitions Farbe Отделки	Евро	шт. pallet Italia	шт. pallet Cont.
<b>Washbasin Blink left top</b> Lavabo Blink plan derecho / Lavabo Blink plan droite / Waschbecken Blink brett links / Раковина Blink с плоской поверхностью слева	75 x 47,5 x 16 h	SMLA75SX(X)	19,00	 <b>Gloss White</b>	<b>476,00</b>	16	32
<b>It would be advisable to have a wall-hung installation of the washbasin. For the installation of an "on top" or semi-recessed basin we recommend to request the RETTIFICA option, specifying the type of installation.</b> Se aconseja para este lavabo la instalación suspendida. Para la instalación de apoyo o semi-empotrado se aconseja la opción "RETTIFICA", especificando el tipo de instalación. / Le lavabo est conseillé pour une installation suspendue. Pour une installation posée ou encastrée sur plan nous conseillons de requérir l'option "RECTIFICATION", en précisant le type d'installation. / Es empfiehlt sich, das Waschbecken hängend zu installieren. Bei Aufsatz oder Halbeinbaumontage bitte die Option "RETTIFICA" anfragen. Bei der Bestellung ,bitte, Montagesorte auch angeben. / Данная раковина предназначена для подвесной установки. При установке на столешницу рекомендуется запросить опцию "RETTIFICA".		<b>RETTIFICA GRINDING РЕКТИФИКАЦИЯ</b>			<b>10,00</b>		
 <b>Towel-rail lateral upper right/left for Blink washbasin</b> Barra para toallas instalación lateral superior para lavabos Blink Porte-serviette installation supérieure latérale pour lavabo Blink Handtuchhalter Installation seitlich oben rechts/links für Aufsatzbecken Blink Полотенцедержатель верхний боковой, правосторонний/левосторонний	46 x 8 h	SMPSS48	0,35	 <b>Chrome</b>	<b>124,00</b>		
 <b>Towel-rail lateral low installation right/left for Blink washbasin</b> Barra para toallas inferior lateral para lavabo Blink Porte-serviette installation inferieure latéral pour lavabo Blink Handtuchhalter Installation seitlich unten für Aufsatzbecken Blink Towel-rail lateral low installation right/left for Blink washbasin	46 x 8 h	SMPSI48	0,35	 <b>Chrome</b>	<b>124,00</b>		
 <b>Towel-rail low frontal installation for Blink washbasin</b> Barra para toallas instalacion inferior para lavabo Blink Porte serviette installation sous meuble pour lavabo Blink Handtuchhalter montage unter dem möbel für Aufsatzbecken Blink Полотенцедержатель нижний боковой, правосторонний/левосторонний	73 x 8 h	SMPSI75	0,50	 <b>Cromo</b>	<b>152,00</b>		

### Technical symbols legend

Símbolos técnicos clave / Légende symboles techniques / Technische Zeichenerklärung / Перечень технических символов

 **one side is unglazed**  
 con un lado sin esmaltar  
 avec un côté non émaillé  
 eine Seite unglasiert  
 одна сторона не покрыта эмалью

 **one tap hole**  
 con 1 agujero  
 monotrou  
 1-Loch  
 одно отверстие  
 под смеситель

 **with overflow**  
 con rebosadero  
 avec trop-plein  
 mit Überlauf  
 с переливом

 **on top installation**  
 instalación de apoyo  
 installation à partir du plan  
 Montage auf Platte  
 установка на столешницу

 **wall-hung installation**  
 instalación suspendida  
 installation suspendue  
 wandhängende Montage  
 подвесная установка





 **semi-recessed installation**  
 instalación semiempotrada  
 installation semi encastrée  
 Halbeinbaumontage  
 подвесная установка

 **with fixing parts**  
 fijaciones incluidas  
 fixations incluses  
 inklusive Befestigungen  
 в комплекте с крепежами

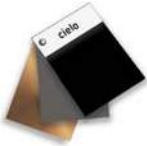

# **Espositori e merchandising**

*Displays and merchandising*

	<b>Size (cm)</b> Medidas Dimensions Maße Размеры	<b>Product code</b> Artículo Article Artikel Артикул	<b>Net weight(Kg)</b> Peso neto Poids net Reingewicht вес нетто	<b>Euro</b> Евро
 <p><b>Sample folder Terre di Cielo</b> Carpeta Terre di Cielo Catalogue nuancier Terre di Cielo Mustermappe Terre di Cielo Папка с образцами Terre di Cielo</p>	21 x 39 x 4,5 h	CCCO	1,90	120,00
 <p><b>Sample folder Acque di Cielo</b> Carpeta Acque di Cielo Catalogue nuancier Acque di Cielo Mustermappe Acque di Cielo Папка с образцами Acque di Cielo</p>	21 x 30 x 2,5 h	CCCA	0,80	120,00
 <p><b>Samples of Oak and Eucalyptus finishes</b> Muestrario de acabados Roble y Eucalipto Échantillonnage des finitions Rovere et Eucalypto Mustersammlung Ausführungen Eiche und Eukalyptus Образцы отделки Rovere и Eucalipto</p>		CCE	0,25	65,00
 <p><b>Metal sample catalogue</b> Muestras de metales Échantillonnage des métaux Mustersammlung Metalle Образцы металла</p>		CCM	0,35	65,00
 <p><b>Fenix sample catalogue</b> Muestrario Fenix Échantillonnage Fenix Mustersammlung Fenix Образцы материала Fenix</p>		CCF	0,15	65,00

## Exhibitors

	<b>Size (cm)</b> Medidas Dimensions Maße Размеры	<b>Product code</b> Artículo Article Artikel Артикул	<b>Net weight(Kg)</b> Peso neto Poids net Reingewicht вес нетто	<b>Finishes</b> Acabados Finitions Farbe Отделки	<b>Euro</b> Евро
 <p><b>Metal display for wall-hung wc and wall-hung bidet</b> Expositor en metal para inodoro y bidet Présentoir en métal pour toilette et bidet suspendus Metallaufsteller für wandhängendes WC und Bidet Экспозитор металлический для подвешенного унитаза и биде</p>	50 x 50 x 65 h	83/E	2,50		97,00

## 5 mm adhesive forex panels

Pannelli in forex 5 mm, con adesivo en la parte posterior

Panneaux adhesives en forex 5 mm

Paneele aus Forex 5mm, beidseitiges Klebeband auf der Rückseite

Панели из материала forex 5 мм

**ON REQUEST** / Bajo pedido / sur demande / Auf Anfrage / ПО ЗАПРОСУ :

- **sizes** / medidas / dimensions / maße / размеры

- **customizations** / personalización / personnalisations / personalisierbar / индивидуализации

- **prices** / precios / prix / preise / цены

**image examples** / Imágenes de muestra / exemples d'images / Bildbeispiele / Образцы картинок





# **Condizioni di vendita**

*Sale terms*

en

## 1. ORDERS

The orders, binding on the customer, must always be considered "unless expressly acceptance of the company".

## 2. PRICES

The prices in this list concern the goods delivered ex-factory. All the invoice costs are at the expense of the customer. The prices are only suggestive and susceptible of change without notice.

## 3. PAYMENT

Every invoice must be settled separately even if there are residuals of orders to be fulfilled. The late payment will cause the application of the interests of default. The contestation of the goods doesn't give the customer the right to suspend or delay the payment.

## 4. PACKAGING

On shipping with a taxable amount lower than 600,00 Eur a fixed amount of 18,00 Eur for packaging fees would be charged.

For taxable amounts exceeding the above amount, will be applied a 3% packaging fee.

## 5. WEIGHT DETAILS - MEASURES - TECHNICALS

Weights and dimensions of items in ceramic are subject to slight variations and must be considered approximate; dimensions quoted at the store or listed in catalogues and price lists may have slight differences due to factory tolerance of ceramic articles. Weights may vary up to 20%. In order to improve our products, Ceramica Cielo LTD reserves the right to vary technical specifications, shape and dimensions quoted at any time and without prior notice.

## 6. SHIPMENTS

The order can be executed by Ceramica Cielo in multiple shipments. Even though it will be dispatched by Ceramica Cielo or on its behalf, the goods travel at the expense, risk and peril of the Buyer, who remains responsible for any breaks or shortages.

## 7. DELIVERY

The date of the delivery is always suggestive. The delivery is considered done when the goods are at disposal in our factory in Fabbrica di Roma.

## 8. WARRANTY

Every item possesses that particular feature of being processed according to purely traditional principles that guarantee its absolute originality and uniqueness. The small variations in colour, hues or streaks on the items are to be considered as qualities and not defects, since they warranty the handcrafted processing which makes each Cielo item a unique and exclusive piece that cannot be compared to industrial standardization. When making the order, the client implicitly accepts those various features that may give rise to claims of any sort. Colour tones on different materials are similar but not identical. The warranty is, in any case, exclusively limited, to the replacement of the goods and subject to compliance with the terms of the law of discovery and dispute, with the exclusion of any other service and accessory charge. In fact, the company will not be responsible for any costs and charges related to assembly, disassembly, installation, etc. for any reason whatsoever. Claims or complaints will not be accepted if not communicated within eight days of the receipt of the goods. Complaints or defects after installation will not be considered if the defected flaw was visible and /or verifiable before installation. Installation implies acceptance of the article itself. The guarantee does not cover defects that, derive from a use that does not conform to the type of product; tampering, alterations, normal deterioration of use, unsuitable maintenance, etc. excluding any responsibility for the use of aggressive, abrasive products, etc. that can deteriorate surfaces. The duration of the product warranty is set at two years from the date of purchase of the product.

## 9. PLACE OF JURISDICTION

For the settlement or definition of any disputes or controversy of any kind and/or nature, the Court of Viterbo (Italy) will be the exclusive place of jurisdiction of the Italian law, even if the contract is agreed/signed elsewhere.

## 10. ONLINE SELLING

Ceramica Cielo does not authorise the sale its products through internet sites or portals, unless expressly authorised.

These general conditions shall be considerate fully accepted by customer in case of purchase .

sp

## 1. PEDIDOS

Los pedidos se comprenden "salvo expresa aceptación de la Casa".

## 2. PERCIOS

Los precios indicados en esta lista se entienden como franco fábrica. Todos los gastos complementarios derivados de la compra son de exclusivo cargo del comprador. Los precios son puramente indicativos y susceptibles de variación sin previo aviso

## 3. PAGOS

Cada factura debe ser abonada separadamente, aunque existan restos de pedidos por entregar. El atraso en el pago causará la aplicación de los intereses de mora.

En caso de reclamación de cualquier naturaleza el comprador no tiene derecho a suspender los pagos.

## 4. EMBALAJE

En todos los envíos con importe inferior a 600.00 euro se aplicará en factura un cargo fijo de 18,00 euro. Para importe superior a la cantidad indicada arriba los gastos de embalaje será igual al 3%.

## 5. PESO - MEDIDAS - TÉCNICO

El peso y el tamaño de los artículos de cerámica son sometidos a ligeras variaciones y deben considerarse aproximados; las medidas que figuran en los catálogos o listas de precios, pueden tener ligeras diferencias debido a tolerancias de fabricación de los objetos de cerámica. El peso puede variar hasta un 20%. Con el fin de mejorar los productos Cerámica CIELO Spa se reserva el derecho a modificar en cualquier momento y sin previo aviso las características, forma ,tamaño y dimensiones técnicas.

## 6. TRANSPORTE

Ceramica Cielo podrá hacer un seguimiento de los envíos. Aunque se envía de Ceramica Cielo o en su nombre, la mercancía viaja a cuenta y riesgo del comprador, quién será el único responsable de roturas o desapariciones."

## 7. ENTREGA

Las fechas de entrega comunicadas son siempre aproximadas y no compromete en ningún caso a Cerámica cielo y pueden sufrir variaciones debidas a diversos factores ajenos a nuestra voluntad. Nada podrá ser atribuible a Cerámica Cielo, en caso de retrasos en las entregas indicadas inicialmente.

## 8. GARANTÍA

Cada objeto tiene la particularidad de estar elaborado según principios puramente tradicionales, de manera para garantizar su absoluta originalidad y singularidad. Cualquier pequeña variación en color, tono o grano entre los artículos deben ser considerados puntos fuertes y no defectos, como garantía de la producción manual del producto, lo que hace de cada objeto Cielo una pieza única y exclusiva, lejos de la homología industrial. En fase de orden, por tanto, estas tolerancias se entienden aceptadas y no pueden dar lugar a reclamaciones de cualquier género. Los tonos de los colores en diferentes materiales son similares pero no idénticos.

La garantía está limitada exclusivamente a la sustitución de los productos y está sujeta al cumplimiento de los términos de la ley de descubrimiento y disputa, con la exclusión de cualquier otro servicio y cargo accesorio. De hecho, la empresa no responderá por ningún motivo, sea cual sea el costo y los cargos relacionados con el montaje, desmontaje, instalación, etc. Las reclamaciones o quejas no se admiten si no se llevan a cabo dentro de los ocho días a partir de la recepción de los bienes. No se admitirán reclamaciones después de la instalación, si el defecto es visible y / o verifiable antes de la instalación. La instalación implica la aceptación del artículo en sí. La garantía no cubre los defectos que se derivan de un uso inapropiado del producto; manipulación, mantenimiento inadecuado, deterioro normal del uso, etc. excluyendo cualquier responsabilidad por el uso de productos agresivos, abrasivos, etc. eso puede deteriorar las superficies. La duración de la garantía del producto se establece en dos años a partir de la fecha de compra del producto.

## 9. FORO COMPETENTE

Por la definición de eventuales controversias de cualquier tipo se considerará competente exclusivamente el foro de Viterbo (Italia) y exclusivamente ley italiana

## 10. VENTA EN LINEA

Ceramica Cielo no autoriza la venta de sus productos a través de sitios web o portales, a menos que esté expresamente autorizado por nuestra parte.

fr

## 1. COMMANDES

Chaque commande, engageante pour le client, doivent être considérés par contre toujours « sauf acceptation de l'entreprise »

## 2. PRIX

Les prix des produits sont ex factory. Les coûts accessoires sont à la charge du destinataire. Les prix sont indicatifs et susceptibles des changements sans préavis.

## 3. PAIEMENT

Chaque facture doit être réglée séparément dans tout cas, aussi s'il y a des commandes restantes. Le retard du paiement comporte l'application des intérêts moratoires. N'importe quelle contestation sur la marchandise donne droit au client de suspendre ou retarder le paiement.

## 4. EMBALLAGE

Pour tous les commandes avec un net montant inférieur à 600.00€ nous appliquerons en facture une contribution fixe pour l'emballage de 18.00€. Pour commandes supérieur au montant susmentionné, les frais d'emballage seront du 3%.

## 5. POIDS - MESURES - TECHNIQUE

Les poids, les dimensions des articles en céramique sont soumis à de légères variations et doivent être considérés comme approximatifs. Les mesures de chantier, reportées dans les catalogues ou tableaux tarifaires peuvent présenter de légères différences dues aux tolérances de fabrication des articles céramiques. Les poids peuvent subir des variations jusqu'à 20%. Dans le but d'améliorer ses produits Ceramica CIELO Spa se réserve le droit à tout moment et sans préavis d'apporter des variations aux caractéristiques techniques, de formes et dimensions.

## 6. EXPEDITIONS:

Le service pourra être effectué par Ceramica Cielo, éventuellement en plusieurs fois. Même si la marchandise est expédiée par Ceramica Cielo ou par un de ses sous-traitants, la marchandise voyage aux frais, risques et dépens de l'Acquéreur. Tout éventuel matériel venant à être endommagé ou manquant sera de la responsabilité exclusive de l'Acquéreur.

## 7. CONSIGNE

Les délais de livraison sont toujours indicatifs et en aucun cas engagés pour Ceramica Cielo. Ils peuvent subir changements à cause de nombreux facteurs. Rien ne peut être imputé à Ceramica Cielo pour retards dans les livraisons initialement indiqués.

## 8. GARANTIE

Chaque objet a la particularité d'être élaboré selon des principes purement traditionnels, afin de garantir son originalité et son unicité absolues. Toutes les petites variations de couleur, de ton ou de grain entre les articles doivent être considérées comme des points forts et pas des défauts, car elles garantissent la fabrication manuelle du produit, qui fait de chaque objet Cielo une pièce unique et exclusive, loin de l'homologation industrielle. A la réception de l'AR, ces tolérances s'entendent donc acceptées, ce qui ne peut donner lieu à des contestations d'aucune sorte. Les tons de couleur des différents matériaux sont similaires mais pas identiques. La garantie est, dans tous les cas exclusivement limitée au remplacement de la marchandise et subordonnée à l'observation des termes de loi de détection et contestation, en excluant toute autre prestation et charge accessoire. L'entreprise ne répondra en aucun cas et pour aucune raison des coûts et frais engendrés par le montage, démontage et pose sur le chantier, etc. Aucune contestation ou réclamation ne sera admise une fois passé le délai de 8 jours à compter de la réception de la marchandise. Les réclamations ou défauts après la pose ne seront pas pris en examen si le défaut contesté résulte visible ou vérifiable avant l'installation. L'installation implique que le produit est accepté tel qu'il est. La garantie ne couvre pas les vices et défauts dérivant d'une utilisation non conforme au type de produit : modifications, altérations, détérioration normale dû à l'usage, entretien non approprié, etc., et exclue toute responsabilité en cas d'utilisation de produits agressifs ou abrasifs, etc., qui sont susceptibles de détériorer les surfaces. La durée de la garantie du produit est de 2 ans, à compter de sa date d'achat.

## 9. TRIBUNAL COMPÉTENT

Tout éventuel litige quant au présent contrat, même si celui-ci est stipulé dans un autre pays, est du ressort exclusif de la loi italienne et sera confié à la compétence exclusive du Tribunal de Viterbo.

## 10. VENTE EN LIGNE

Ceramica Cielo n'autorise en aucun cas la vente de ses produits par le biais de sites ou portails internet, sous réserve d'une autorisation expresse spéciale préalablement accordée.

Cette conditions générales seront considérées comme entièrement acceptées du Client en cas d'achat.

de

## 1. BESTELLUNGEN

Die Bestellungen von, verbindlich für den Kunden, brauchen immer die „ offene Bestätigung von der Firma „ zu haben.

## 2. PREISE

Die Preise von dieser Preisliste sind immer Ab werk. Die sind nur indikative Preise, die ändern können. Der Kund muss alle weitere Koste bezahlen.

## 3. BEZAHLUNGEN

Jede Rechnung muss reguliert sein, obwohl es weitere gebliebene Bestellungen zu senden gab. Die Verspätung von der Bezahlung gibt uns Rechts Verzugszins zu applizieren. Keine Reklamation darf dem Kund die Möglichkeit Bezahlungen abzulehnen.

## 4. VERPACKUNG

Zu jeder Lieferung ab € 600,- wird eine Beteiligung für die Verpackungskosten angefragt, in der Regel sind das 3% vom Warenwert; zu jeder Lieferung unter € 600,-, wird die Beteiligung i.H.v. € 18 € / Lieferung sein.

## 5. GEWICHTE - MASSE - TECHNISCHE

Gewicht und Abmessungen der Artikel aus Keramik unterliegen geringfügigen Variationen und sind daher als Näherungswerte zu verstehen. Die in den Katalogen und Preislisten angegebenen technischen Maße können leichte Abweichungen aufweisen, die auf die Fertigungstoleranzen von Keramikartikeln zurückzuführen sind. Beim Gewicht kann es zu Variationen von bis zu 20 % kommen. Zum Zwecke einer konstanten Verbesserung ihrer Produkte behält sich Ceramica CIELO Spa vor, die technischen Merkmale, Formen und Abmessungen jederzeit ohne Vorankündigung zu ändern.

## 6. LIEFERUNG

Aufträge können von Ceramica Cielo auch über mehrere Teillieferungen abgewickelt werden. Der Transport der Ware erfolgt auf Kosten und auf Gefahr des Käufers, auch dann, wenn er von Ceramica Cielo oder auf deren Rechnung vorgenommen wird, und eventuelle Beschädigungen und Fehlmengen gehen ausschließlich zu Lasten des Käufers.

## 7. ERHALTUNG

Der Liefertermin ist immer indikativ. Die Erhaltung erfolgt durch die Bereitung und die Verfügbarkeit der Ware an unserem Lager von Fabrica di Roma.

## 8. GEWÄHRLEISTUNG

Die Besonderheit der einzelnen Elemente besteht darin, dass sie ausschließlich unter Anwendung traditioneller Kriterien verarbeitet werden, als Garantie für ihre Originalität und Einzigartigkeit. Mögliche geringfügige Abweichungen der Farbe, Nuance oder Maserung verschiedener Artikel sind daher nicht als Mängel sondern als Vorzüge anzusehen: sie sind eine Garantie für handwerkliche Herstellung, dank derer jedes Produkt von Cielo ein exklusives Einzelstück ist, fern von der industriellen Standardisierung. Im Falle einer Bestellung verstehen sich diese Toleranzen als akzeptiert und können daher nicht als Reklamationsgrund, gleich welcher Art, verwendet werden. Die Farbtöne unterschiedlicher Materialien sind ähnlich, nicht aber identisch. Die Gewährleistung beschränkt sich in jedem Falle ausschließlich auf den Ersatz der Ware, und unterliegt bezüglich Feststellung und Reklamation der Einhaltung der gesetzlichen Vorschriften, unter Ausschluss aller weiteren Leistungen und Nebenkosten. Das Unternehmen haftet in keinem Fall, gleich aus welchem Grund, für Kosten und Aufwendungen, die durch Montage, Demontage, Installation usw. entstehen. Beanstandungen oder Reklamationen, die nicht innerhalb der Frist von acht Tagen nach Erhalt der Ware vorgenommen werden, gelten als nicht akzeptiert. Reklamationen oder Mängel nach der Installation werden nicht berücksichtigt, falls der beanstandete Mangel vor der Installation sichtbar oder überprüfbar war. Die Installation impliziert die Akzeptanz des Artikels. Die Gewährleistung deckt keine Mängel ab, die durch einen nicht mit dem Produkttyp konformen Einsatz, Manipulationen, Veränderungen, normale Gebrauchsabnutzung, unsachgemäße Unterhaltspflege usw. entstehen, und schließt jede Haftung für den Einsatz aggressiver, scheuernder u.ä. Produkte aus, durch die die Oberflächen Schaden nehmen können. Die Gewährleistungsdauer beträgt zwei Jahre ab Kaufdatum des Produkts.

## 9. GERICHTSSTAND

Zur Beilegung eventueller Streitigkeiten, gleich welcher Art, ist ausschließlich das Gericht von Viterbo zuständig, und es gilt ferner ausschließlich italienisches Recht, auch wenn der Vertrag an einem anderen Ort geschlossen wurde. Die obigen AGB gelten ab dem Zeitpunkt des Kaufs der Produkte als vom Auftraggeber zur Gänze akzeptiert.

## 10. ONLINE-VERKAUF

Ceramica Cielo genehmigt keinerlei Online-Verkäufe ihrer Produkte, weder auf Websites im Internet noch über Portale. Hierfür ist unsere ausdrückliche Zustimmung erforderlich.

ru

## 1. ЗАКАЗЫ

Заказы, полученные от клиентов, считаются принятыми при условии подтверждения принятия данных заказов фабрикой.

## 2. ЦЕНЫ

Цены, указанные в данном прайс-листе, относятся к товару с учетом поставки «франко-фабрика». Все расходы, сопутствующие покупке, ложатся исключительно на Покупателя. Цены являются ориентировочными и могут претерпевать изменения без какого-либо предупреждения. Указанные цены не включают НДС.

## 3. ОПЛАТА

Каждая фактура должна оплачиваться отдельно, даже если часть заказа требует дополнительного времени для выполнения. Задержка в оплате приведет к начислению процентов по задолженности. Рекламация на товар не дает Покупателю права приостановить или задержать оплату.

## 4. УПАКОВКА

На все заказы, стоимость которых не превышает 600 евро, будет начисляться фиксированная сумма на расходы по упаковке в размере 18 евро. Если стоимость заказа превышает вышеуказанную сумму, то расходы на упаковку составят 3%

## 5. ВЕС - РАЗМЕРЫ - ТЕХНИЧЕСКИЕ

Вес, размеры артикулов из керамики могут быть подвержены небольшим изменениям и должны считаться приблизительными; значения, приведенные в каталогах или прайс-листах, могут слегка отличаться от реальных в связи с производственными допусками для изделий из керамики. Различия в весе могут достигать 20%. С целью совершенствования изделий Ceramica CIELO Spa оставляет за собой право в любой момент и без предупреждения изменять технические характеристики и размерные значения.

## 6. ОТГРУЗКИ

Заказ может быть отгружен фабрикой Cielo несколькими партиями. Отгрузка осуществляется за счет Покупателя, также на него ложатся все риски, даже в случае отгрузки непосредственно с фабрики или по ее поручению третьими лицами. Исключаются любые возмещения за возможный бой товара или недостачу.

## 7. ПОСТАВКА

Даты поставки всегда являются ориентировочными и не налагают каких-либо обязательств на Ceramica Cielo, кроме того, они могут изменяться вследствие многочисленных причин, не зависящих от намерений. Поэтому задержки поставок относительно изначально указанных дат не могут вменяться в вину компании Ceramica Cielo.

## 8. ГАРАНТИЯ

Особенность каждого изделия заключается в исконно традиционных принципах производства, которые гарантируют абсолютную оригинальность и уникальность изделий. Небольшие различия в цвете, тоне или текстуре между изделиями следует рассматривать как достоинства, а не дефекты, поскольку они подтверждают ручное производство изделий, что делает каждое изделие Cielo уникальным и эксклюзивным, далеким от промышленной омологии. Таким образом, при оформлении заказа эти допуски принимаются и это не может привести к какому-либо спорам. В любом случае, гарантия ограничивается только заменой товара, при условии соблюдения сроков, предусмотренных законом, на обнаружение и заявление о рекламации, любые другие претензии или дополнительные обязательства не могут быть предъявлены. При любых обстоятельствах, компания, не несет ответственности за дополнительные издержки и расходы, связанные с установкой, демонтажем, укладкой и т.д. Рекламации или жалобы не рассматриваются, если они поданы после истечения восьми дней от даты получения товара. Тональность цвета на разных материалах похожа, но не идентична. После установки любые обнаруженные рекламации или недостатки не рассматриваются, если указанный брак был видимый/или мог быть обнаружен до начала установки. Установка означает подтверждение приема данного товара. Гарантия не распространяется на брак, по причине ненадлежащего применения данного вида товара; нарушения целостности, нормального износа товара, несоответствующего обслуживания и т.д., таким образом, исключая любую ответственность в случае применения агрессивных, абразивных средств и т.д., которые могут повредить поверхность. Срок действия гарантии – 2 года с момента приобретения товара.

## 9. КОМПЕТЕНТНЫЙ ОРГАН

Для решения всех возможных споров любого рода и происхождения компетентным является исключительно суд города Витербо, исключительно в соответствии с итальянским законодательством, независимо от места подписания договора. Все вышеуказанные общие условия считаются полностью принятыми заказчиком с момента приобретения продукции.

## 10. продажа в режиме онлайн

Ceramica Cielo запрещает любую продажу своих товаров через интернет-сайты или порталы без предварительного разрешения.







Settembre 2023

Print Telligraf

© Tutti i diritti sono riservati.

Nessuna parte di questo catalogo può essere riprodotta o trasmessa in qualsiasi forma o con qualsiasi mezzo elettronico, meccanico o altro senza l'autorizzazione scritta dei proprietari dei diritti.

© All rights reserved. No part of this catalogue may be reproduced or transmitted in any form or by any electronic, mechanical or other means without the written permission of the owners of the rights.