



# Lavabi Washbasins

A terra e sospesi, Freestanding and wall hung

# Indice

## Summary

04	<b><u>Overview</u></b>
06	Smoking
16	O_O
28	Discovolante
40	Fonte totem
44	Fonte
50	Hole
54	Unico rotondo
58	Argo
62	Unico
70	Roll
76	Funnel
80	<b><u>Informazioni tecniche</u>   <u>Technical informations</u></b>

Rexa Design dà vita ad uno spazio bagno concepito non soltanto per trasmettere serenità e benessere, ma anche per ispirare chi lo vive. Tutto ciò si realizza grazie alla presenza di oggetti che caratterizzano l'ambiente, infondendogli personalità.

Rexa Design presenta il suo programma completo di lavabi freestanding, che combinano sensorialità e funzionalità, imponendosi come protagonisti della stanza da bagno, senza mai smettere di dialogare con gli elementi circostanti.

Rexa Design gives life to a space bathroom designed not only for transmit peacefulness and well-being, but also to inspire those who live it. All this is achieved through the presence of objects that characterize the environment, by giving it personality. Rexa Design presents its complete range of freestanding washbasins, which combine a sensory experience with the functionality, imposing itself as protagonists of the bathroom, but always connected to the surrounding elements.

Rexa Design donne vie à un espace salle de bain conçu pas seulement pour transmettre la tranquillité et le bien-être, mais aussi pour inspirer ceux qui la vivent. Tout cela se réalise par la présence d'objets qui caractérisent l'ambiance, en lui donnant de la personnalité. Rexa Design présente sa gamme complète de lavabos en îlot, qui combinent une expérience sensorielle avec la fonctionnalité, et s'imposent comme protagonistes de la salle de bain, en restant toujours connectés aux autres éléments de la salle de bain.

Rexa Design schafft ein Badezimmer, die nicht nur Ruhe und Wohlbefinden vermittelt, sondern auch die Menschen inspiriert. All dies geschieht durch das Vorhandensein von Objekten, die den Raum prägen und ihm Persönlichkeit verleihen. Rexa Design präsentiert sein komplettes Freestanding-Waschbeckenprogramm, welches Sinnlichkeit und Funktionalität kombiniert und sich als Protagonisten im Badezimmer aufdrängt, die aber nie aufhören, mit den umliegenden Elementen zu verhandeln.

Rexa Design da vida a un espacio de baño concebido no solo para transmitir serenidad y bienestar, sino también para inspirar a quienes lo viven. Todo esto se consigue gracias a la presencia de objetos que caracterizan el ambiente, dotándolo de personalidad. Rexa Design presenta su completo programa de lavabos a suelo, que combinan sensorialidad y funcionalidad, consolidándose como los protagonistas del baño, que sin embargo no deja de comunicarse con los elementos circundantes.

# Overview



Smoking  
P 06



O\_O  
P 16



Discovolante  
P 28



Fonte totem  
P 40



Fonte  
P 44



Hole  
P 50



Unico rotondo  
P 54



Argo  
P 58



Unico  
P 62



Roll  
P 68



Funnel  
P 74

# Smoking

design by Daniele Della Porta

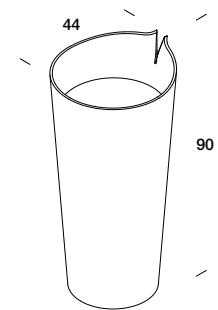

Lavabi a terra e sospesi

Smoking

6



7

Smoking

Freestanding and wall hung washbasins



Lavabo Smoking freestanding in Corian® Deep Nocturne Ø44x90h cm. Miscelatore a parete Drop nero opaco. Specchiera Filolucido 200x48h cm con illuminazione perimetrale a LED. Mensole contenitive a parete in lamiera opaca nera.

Smoking freestanding washbasin in Corian® Deep Nocturne Ø44x90h cm. Matt black wall-mounted mixer Drop. Filolucido mirror 200x48h cm with LED light. Black metal storage shelves.

Lavabo Smoking en îlot en Corian® Deep Nocturne Ø44x90h cm. Mitigeur a paroi Drop noir mat. Miroir Filolucido 200x48h cm avec éclairage LED. Étagères en métal noir mat.

Smoking Freestanding-Waschbecken aus Corian® Deep Nocturne Ø44x90h cm. Schwarz matt Drop Einbau-Wannenmischer. Filolucido Spiegel 200x48h cm mit LED Raumbelichtung. Schwarz matt Rückhalteregale aus Blech.

Lavabo Smoking a suelo en Corian® Deep Nocturne Ø44x90h cm. Mezclador a pared Drop en negro mate. Espejo Filolucido 200x48h cm con iluminación LED perimetral. Estantes a pared en lámina negra mate.

– Making of Smoking

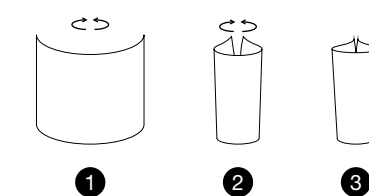

# Smoking

design by Daniele Della Porta

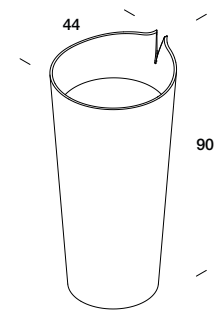

Lavabi a terra e sospesi

Smoking



Smoking

Freestanding and wall hung washbasins





Lavabo Smoking freestanding  
in Corian® Glacier White  
Ø44x90h cm con miscelatore  
Drop a parete nero opaco.  
Specchiera R1 contenitiva a  
incasso 90x12x70h cm.  
Appendini Moon Ø 4 cm in Corian®  
Ash Aggregate e sgabello Fonte  
in frassino tinto olmo  
44x38x40h cm.

Smoking freestanding washbasin  
in Corian® Glacier White  
Ø44x90h cm with Drop black matt  
wall-mounted mixer. R1 recessed  
cabinet mirror 90x12x70h cm.  
Moon hooks Ø 4 cm in Corian®  
Ash Aggregate and Fonte stool  
in wood 44x38x40h cm.

Lavabo Smoking en îlot en  
Corian® Glacier White Ø44x90h cm  
avec mitigeur Drop a paroi noir mat.  
Armoire miroir encastré R1  
90x12x70h cm. Crochet Moon  
4 cm en Corian® Ash Aggregate  
et tabouret Fonte en bois  
44x38x40h cm.

Smoking Freestanding-  
Waschbecken aus Corian® Glacier  
White Ø44x90h cm mit schwarz  
matt Drop Einbau-Wannenmischer.  
R1 Einbau-Spiegel 90x12x70h cm.  
Moon Haken Ø 4 cm aus Corian®  
Ash Aggregate und Fonte Hocker  
aus Eschenholz 44x38x40h cm.

Lavabo Smoking a suelo en Corian®  
Glacier White Ø44x90h cm con  
Mezclador Drop de pared negro  
mate. Espejo contenedor  
empotrado R1 90x12x70h cm.  
Perchas Moon Ø 4 cm en Corian®  
Ash Aggregate Taburete Fonte en  
fresno pintado olmo 44x38x40h cm.

# Smoking



**A terra**  
Freestanding

## Overview

a terra  
freestanding



Ø 44 H 90

## Finiture | Finishes

Corian®



glacier  
white

deep  
nocturne

## Miscelatori abbinabili | Combinable mixers

Mae

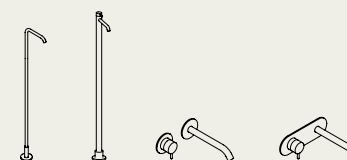

Drop



# O\_O

design by Bartoli Design

Lavabo O\_O freestanding in marmo Carrara Ø50x90h cm.

O\_O freestanding washbasin in Carrara marble Ø50x90h cm.

Lavabo O\_O en ilôt en marbre Carrare Ø50 x 90h cm.

O\_O Waschbecken aus Carrara Marmor Ø50x90h cm.

Lavabo O\_O a suelo en marmol Carrara Ø50x90h cm.

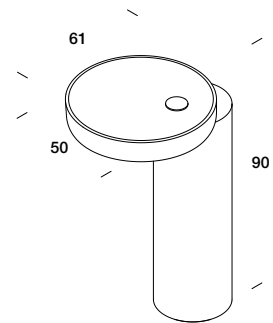



# O\_O

design by Bartoli Design

Lavabo O\_O freestanding  
in marmo Nero Marquinia  
Ø50x90h cm con miscelatore  
da piano Mae in Black Luxury.

O\_O freestanding washbasin  
in Nero Marquinia marble  
Ø50x90h cm with Mae floor  
mixer in Black Luxury.

Lavabo en ilôt en marbre noir  
Marquinia Ø50x90h cm avec  
mitigeur au sol Mae en  
Black Luxury.

O\_O Waschbecken aus Nero  
Marquina Marmor Ø50x90h cm  
mit Black Luxury Mae  
Waschtischmischer.

Lavabo O\_O a suelo en mármol  
Nero Marquinia Ø50x90h cm  
con Mezclador para lavabo  
Mae en acero Black Luxury.

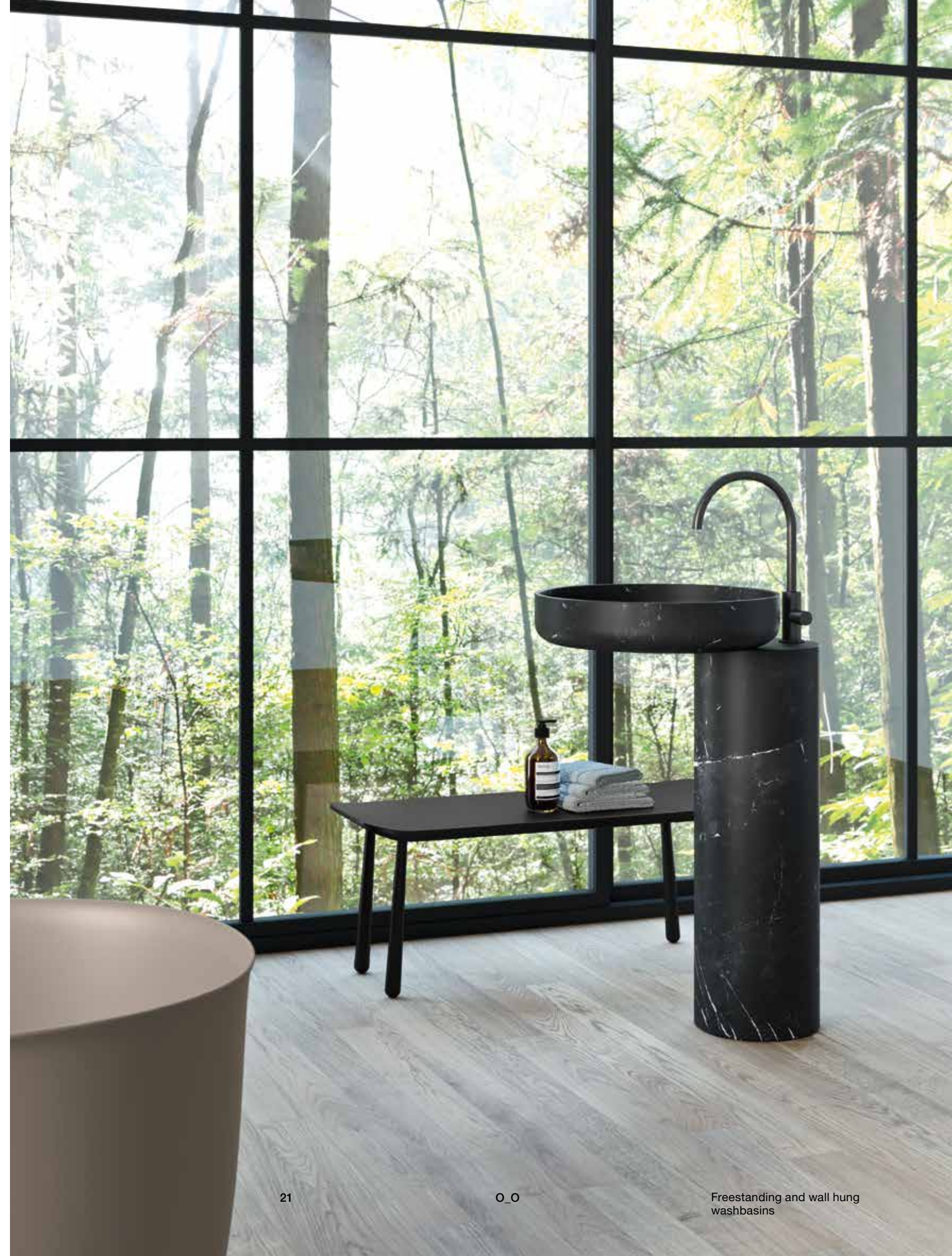
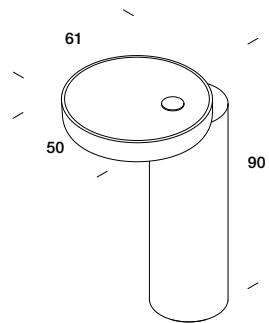

O\_O

design by Bartoli Design

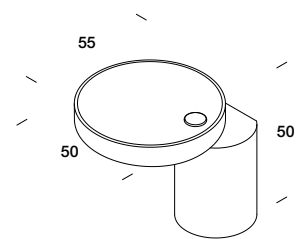

Lavabi a terra e sospesi

O\_O

22



23

O\_O

Freestanding and wall hung washbasins



Lavabo O\_O sospeso in Corian®  
Dune Prima con base in Glacier  
White Ø50x50h cm e miscelatore  
Mae da piano in Black Luxury.  
Specchiera Halo Ø42 cm con  
cornice in Corian® Deep Nocturne.  
Portasalviette dedicato in acciaio  
Inox satinato.

O\_O suspended washbasin in  
Corian® Dune Prima with base  
in Glacier White Ø50x50h cm  
and Mae deck mounted mixer  
in Black Luxury.  
Halo mirror Ø42 cm with frame  
in Corian® Deep Nocturne.  
Towel holder in brushed  
stainless steel.

Lavabo O\_O suspendu en Corian®  
Dune Prima avec base en Glacier  
White Ø50x50h cm et mitigeur  
Mae en Black Luxury. Miroir Halo  
Ø42 cm avec cadre en Corian®  
Deep Nocturne. Porte-serviettes  
en acier Inox satiné.

O\_O Wand-Waschbecken aus  
Corian® Dune Prima mit Basis  
aus Glacier White Ø50x50h cm  
und Black Luxury Mae  
Waschtischmischer. Halo Spiegel  
Ø42 cm mit Rahmen aus Corian®  
Deep Nocturne. Handtuchhalter  
aus Satin-Edelstahl.

Lavabo suspendido O\_O de Corian®  
Dune Prima con base en Glacier  
White Ø50x50h cm y mezclador  
para lavabo Mae en acero Black  
Luxury. Espejo Halo Ø42 cm con  
marco en Corian® Deep Nocturne.  
Toallero dedicado en acero  
inoxidable satinado.



**Portasalviette**  
Towel rail



**A terra**  
Freestanding



**Sospeso**  
Wall hung

**Overview**

**a terra**  
freestanding

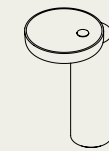

Ø 50 (lavabo | washbasin)  
L 50 P 61 H 90

**sospeso**  
wall hung

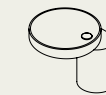

Ø 50 (lavabo | washbasin)  
L 50 P 55 H 50

**Finiture | Finishes**

**Corian®**



**Marmo | Marble**

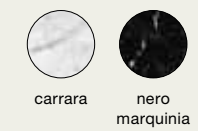

**Accessori abbinabili | Combinable accessories**



**portasalviette**  
towel rail



**appendino**  
hook

**Miscelatori abbinabili | Combinable mixers**

**Mae**

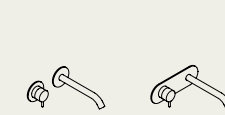

O\_O

**Drop**



Freestanding and wall hung washbasins

# Discovolante

design by Monica Graffeo

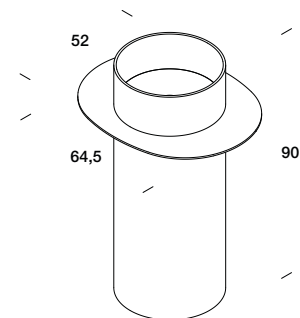

Lavabi a terra e sospesi

Discovolante

28

29

Discovolante

Freestanding and wall hung washbasins







Lavabo Discovolante in Corian® Deep Nocturne Ø37x90h cm con piano in vetro Grigio 64x52 cm e miscelatore Drop nero opaco. Specchiera Brame con cornice in vetro Grigio Ø 80 cm. Appendino dedicato in acciaio nero opaco.

Discovolante washbasin in Corian® Deep Nocturne Ø37x90hcm with Grey glass top 64x52 cm and matt black Drop mixer. Brame mirror with frame in Grey glass Ø80 cm. Hanger in black mat steel.

Lavabo Discovolante en Corian® Deep Nocturne Ø37x90h cm avec plan étagère en verre gris 64x52 cm et mitigeur Drop noir mat. Miroir Brame avec cadre en verre Gris Ø80 cm. Crochet en acier noir mat.

Discovolante Waschbecken aus Corian® Deep Nocturne Ø37x90h cm mit Regal aus graue Glas 64x52 cm und schwarz matt Drop Mischer. Brame Spiegel mit Rahmen aus graues Glas Ø 80 cm. Haken aus schwarz matt Edelstahl.

Lavabo Discovolante en Corian® Deep Nocturne Ø37x90h cm con encimera de vidrio Gris 64x52 cm y mezclador Drop negro mate. Espejos Brame con marco Vidrio Gris Ø 80 cm. Percha dedicada en acero negro opaco.



# Discovolante

design by Monica Graffeo

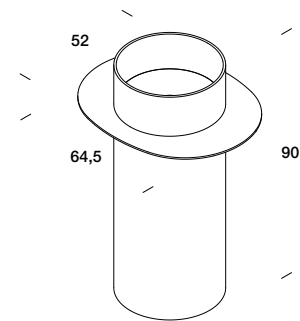

Lavabi a terra e sospesi

Discovolante

32



33

Discovolante

Freestanding and wall hung washbasins



Lavabo Discovolante in Corian® Glacier White Ø37x90h cm con piano in marmo Carrara 64x52 cm e miscelatore Mae a parete satinato. Specchiera Filolucido Ø 70 cm con lampada Spin per specchiera Ø 20 cm in Corian® Glacier White con illuminazione a LED orientabile.

Discovolante washbasin in Corian® Glacier White Ø37x90h cm with Carrara marble top 64x52 cm and Mae wall-mounted mixer in brushed steel. Filolucido mirror Ø70 cm with Spin lamp for mirror 20 cm in Corian® Glacier White with adjustable LED lighting.

Lavabo Discovolante in Corian® Glacier White Ø37x90h cm avec Plan étagère en marbre Carrara 64x52 cm et Mae mitigeur à paroi en acier brossé. Miroir Filolucido Ø70 cm avec lampe Spin pour miroir 20 cm en Corian® Glacier White avec éclairage LED orientable.

Discovolante Waschbecken aus Corian® Glacier White Ø37x90h cm mit Carrara Marmor Ablage 64x52 cm und Mae Satin-Wandwaschtischmischer. Filolucido Spiegel Ø 70 cm mit Spin Lampe Ø 20 cm aus Corian® Glacier White mit orientierbarer LED Beleuchtung.

Lavabo Discovolante en Corian® Glacier White Ø37x90h cm con encimera de mármol Carrara 64x52 cm y mezclador Mae de pared satinado. Espejo Filolucido Ø 70 cm con lámpara Spin para espejo Ø 20 cm en Corian® Glacier White con iluminación LED orientable.



Corian® Glacier White + Corian® Glacier White



Corian® Glacier White + Corian® Ash Aggregate



Corian® Deep Nocturne + Corian® Deep Nocturne



Corian® Deep Nocturne + Corian® Carbon Aggregate



Corian® Glacier White + Vetro bronzo / Bronze glass



Corian® Deep Nocturne + Marmo Nero Marquina / Nero Marquina marble

# Discovolante



Portasalviette  
Towel rail



A terra  
Freestanding

## Overview

a terra  
freestanding

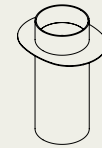

Ø 37 (lavabo | washbasin)  
L 64,5 P 52 H 90

## Finiture | Finishes

Corian® (Lavabo | Basin)



Corian® (Mensola | Shelf)



Vetro | Glass (Mensola | Shelf)



Marmo | Marble (Mensola | Shelf)



## Accessori abbinabili | Combinable accessories



appendino  
hook

## Miscelatori abbinabili | Combinable mixers

Mae



Discovolante

Drop



Freestanding and wall hung washbasins

# Fonte totem

design by Monica Graffeo

Lavabo Fonte Totem freestanding 80x48x90h cm in Corian® Glacier White con miscelatore Drop nero opaco. Appendini Moon Ø 4 cm in Corian® Deep Nocturne. Lampada Arm a parete in vetro bianco e sgabello Fonte in frassino tinto olmo Ø 28x43h cm.

Fonte Totem freestanding washbasin 80x48x90h cm in Corian® Glacier White with matt black Drop mixer. Hangers Moon Ø4 cm in Corian® Deep Nocturne. Arm wall lamp in white glass and Fonte stool in wood 28x43h cm.

Lavabo en ilòt Fonte Totem 80x48x90h cm en Corian® Glacier Blanc avec mitigeur Drop noir mat. Crochet Moon Ø4 cm en Corian® Deep Nocturne. Lampe Arm à paroi en verre blanc et tabouret Fonte bois 28x43h cm.

Fonte Totem Freestanding-Waschbacken 80x48x90h cm aus Corian® Glacier White mit Schwarz matt Drop Mischer. Moon Hänger Ø 4 cm aus Corian® Deep Nocturne. Arm Wandlampe aus weiss Glas und Fonte Hocker aus Eschenholz Ø 28x43h cm.

Lavabo Fonte Totem a suelo 80x48x90h cm in Corian® Glacier White con mezclador Drop negro opaco. Percha Moon Ø 4 cm en Corian® Deep Nocturne. Lámpara Arm de pared en vidrio blanco y taburete Fonte en fresno pintado Olmo Ø 28x43h cm.

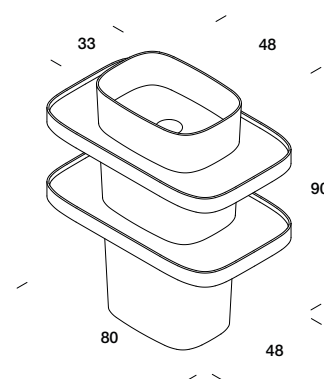



# Fonte Totem



**A terra**  
Freestanding



**Sospeso**  
Wall hung

## Overview

**a terra**  
freestanding

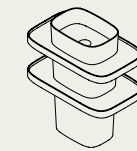

L 48 P 33 (lavabo | washbasin)  
L 80 P 48 H 90

**sospeso**  
wall hung

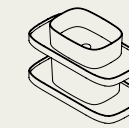

L 48 P 33 (lavabo | washbasin)  
L 80 P 48 H 50

**sospeso**  
wall hung

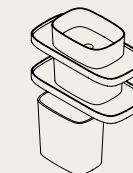

L 48 P 33 (lavabo | washbasin)  
L 80 P 48 H 90

## Finiture | Finishes

Corian®



glacier  
white

## Miscelatori abbinabili | Combinable mixers

Mae

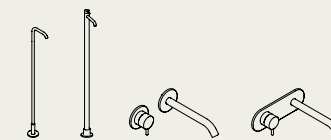

Drop



# Fonte

design by **Monica Graffeo**

Lavabo Fonte freestanding in Corian® Glacier White 48x34x90h cm con miscelatore a terra Mae in acciaio Inox satinato. Specchiera Filolucido 90x200h cm e lampada Metrolineare nera L 120 cm. Appendino dedicato in faggio naturale.

Fonte freestanding washbasin in Corian® Glacier White 48x34x90h cm with floorstanding mixer Mae in brushed stainless steel. Filolucido mirror 90x200h cm and Metrolineare black light L 120 cm. Hanger in wood.

Lavabo Fonte en îlôt en Corian® Glacier White 48x34x90h cm avec mitigeur Mae au sol en acier satiné. Miroir Filolucido 90x200h cm et lampe Metrolineare noire L 20 cm. Crochet en bois.

Fonte Freestanding-Washbecken aus Corian® Glacier White 48x34x90h cm mit Mae bodenstehender Waschtischmischer aus Satin-Edelstahl. Filolucido Spiegel 90x200h cm und schwarze Metrolineare Lamp L 120 cm. Haken aus Buchenholz.

Lavabo Fonte independiente en Corian® Glacier White 48x34x90h cm con mezclador a suelo Mae en acero inoxidable satinado. Espejo Filolucido 90x200h cm y la lámpara Metrolineare negro L 120 cm. Percha dedicada en haya natural.

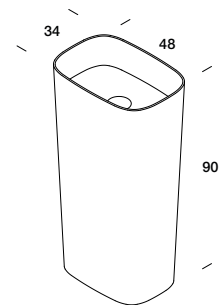

Lavabi a terra e sospesi

Fonte

44



45

Fonte

Freestanding and wall hung washbasins





Appendino  
Hook

# Fonte



**A terra**  
Freestanding



**Sospeso**  
Wall hung



**Sospeso con cassetto**  
Wall hung with drawer

## Overview

**a terra**  
freestanding



L 48 P 34 H 90

**sospeso**  
wall hung

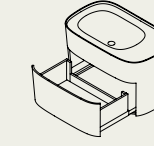
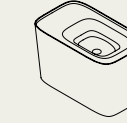
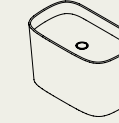

L 80 P 48 H 50

## Finiture | Finishes

\* Disponibile solo per Fonte a terra | Available only for freestanding Fonte

Corian®



glacier  
white



deep  
nocturne\*

## Accessori abbinabili | Combinable accessories



appendino  
hook

## Miscelatori abbinabili | Combinable mixers

Mae

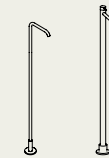

Drop



# Hole

design by Susanna Mandelli

Lavabo Hole freestanding in Corian® Glacier White Ø 41x90h cm con interno in Corian® Deep Nocturne e miscelatore Mae a parete in Black Luxury.

Hole freestanding washbasin in Corian® Glacier White Ø41x90h cm with inside part in Corian® Deep Nocturne and Mae wall-mounted mixer in Black Luxury.

Lavabo Hole en îlot en Corian® Glacier White Ø 41x90h cm avec partie interne en Corian® Deep Nocturne et mitigeur Mae a paroi en Black Luxury.

Hole Freestanding-Waschbecken aus Corian® Glacier White Ø 41x90h cm mit Innenseite aus Corian® Deep Nocturne und Mae Black Luxury Wandwaschtischmischer.

Lavabo Hole a suelo in Corian® Glacier White Ø 41x90h cm con Interior en Corian® Deep Nocturne y mezclador Mae a pared en Black Luxury.

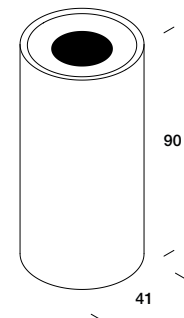



# Hole



**A terra**  
Freestanding



**Sospeso**  
Wall hung

## Overview

**a terra**  
freestanding



Ø 41 H 90

**sospeso**  
wall hung



Ø 41 H 50

## Finiture | Finishes

Corian®



glacier  
white +  
deep  
nocturne

## Miscelatori abbinabili | Combinable mixers

Mae

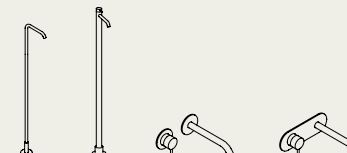

53

Drop



Hole

Freestanding and wall hung  
washbasins

# Unico rotondo

design by Rexa Design Studio

Lavabo Unico rotondo freestanding in Corian® Deep Nocturne Ø41x90h cm con miscelatore a terra Mae in acciaio Inox satinato. Specchiera Halo Ø72 cm con cornice in Corian® Deep Nocturne.

Unico Rotondo freestanding washbasin in Corian® Deep Nocturne Ø41x90h cm with Mae floorstanding mixer in brushed stainless steel. Halo mirror Ø72 cm with frame in Corian® Deep Nocturne.

Lavabo Unico Rotondo en îlot en Corian® Deep Nocturne Ø41x90h cm avec mitigeur au sol Mae en acier satiné. Miroir Halo Ø72 cm avec cadre en Corian® Deep Nocturne.

Unico rotondo Freestanding-Waschbecken aus Corian® Deep Nocturne Ø41x90h cm mit Mae bodenstehender Waschtischmischer aus Satin-Edelstahl. Halo Spiegel Ø72 cm mit Rahmen aus Corian® Deep Nocturne.

Lavabo Único redondo a suelo en Corian® Deep Nocturne Ø41x90h cm con mezclador a suelo Mae en acero inoxidable satinado. Espejo Halo Ø72 cm con marco en Corian® Deep Nocturne.

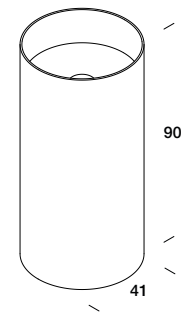



# Unico rotondo



**A terra**  
Freestanding



**Sospeso**  
Wall hung

## Overview

**a terra**  
freestanding



Ø 41 H 90

**sospeso**  
wall hung



Ø 41 H 50

## Finiture | Finishes

Corian®



## Accessori abbinabili | Combinable accessories



**appendino**  
hook

## Miscelatori abbinabili | Combinable mixers

**Mae**



**Drop**

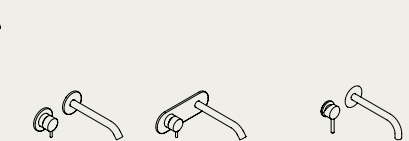

# Argo

design by Imago Design

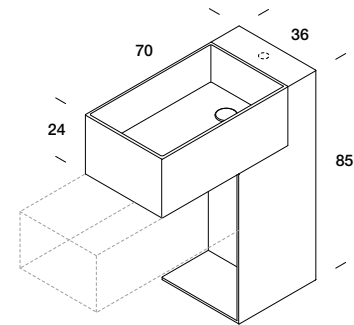

Lavabi a terra e sospesi

Argo



Argo

Freestanding and wall hung washbasins



Lavabo Argo freestanding in Corian® Silver Grey 70x36x85h cm con cassetto in accosto in Corian® Deep Nocturne con frontale in Eucalipto 70x36x24h cm. Specchiera Filolucido 70x90h cm.

Argo freestanding washbasin in Corian® Silver Grey 70x36x85h cm with drawer in Corian® Deep Nocturne with front door in Eucalyptus 70x36x24h cm. Filolucido mirror 70x90h cm.

Lavabo Argo en îlot en Corian® Silver Grey 70x36x85h cm avec tiroir en Corian® Deep Nocturne avec façade en eucalyptus 70x36x24h cm. Miroir Filolucido 70x90h cm.

Argo Freestanding-Waschbecken aus Corian® Silver Grey 70x36x85h cm mit Schublade aus Corian® Deep Nocturne mit Vorderseite aus Eucalypto 70x36x24h cm. Filolucido Spiegel 70x90h cm.

Lavabo Argo a suelo en Corian® Silver Grey 70x36x85h cm con cajón en el lado de Corian® Deep Nocturne con frontal Eucalipto 70x36x24h cm. Espejo Filolucido 70x90h cm.

# Argo



**A terra**  
Freestanding



**Sospeso**  
Wall hung

## Overview

a terra  
freestanding  
— dx / sx

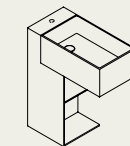

L 70 P 36 H 85

sospeso  
wall hung  
— dx / sx

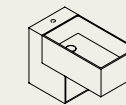

L 70 P 36 H 48

cassetto  
drawer

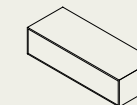

L 70 P 36 H 24

Scocca: Corian®  
Frontale: Corian® / legno  
Carcase: Corian®  
Frontal: Corian® / wood

## Finiture | Finishes

Corian® (lavabo e cassetto | washbasin and drawer)



Legno | Wood (frontale | frontal)



## Miscelatori abbinabili | Combinable mixers

Mae

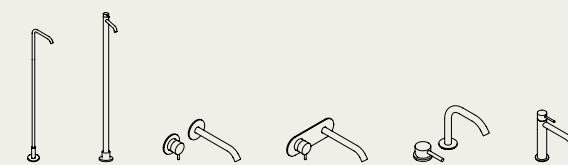

61

Drop



Argo

Freestanding and wall hung washbasins



# Unico

design by Rexa Design Studio

Lavabo Unico freestanding con pianetto interno laterale ribassato 50x36x85h cm in Corian® Dune Prima. Miscelatore Mae a parete in acciaio Inox satinato. Specchiera Filolucido 50x80h cm con lampada Spin in Corian® Dune Prima 20x40h cm con illuminazione a led orientabile. Appendini Stone nello stesso materiale.

Unico freestanding washbasin with internal shelf 50x36x85h cm in Corian® Dune Prima. Mae wall-mounted mixer in brushed stainless steel. Filolucido mirror 50x80h cm with Spin lamp in Corian® Dune Prima 20x40h cm and adjustable led lighting. Stone hangers in the same material.

Lavabo Unico en îlot avec Tablette interne 50x36x85h cm en Corian® Dune Prima. Mitigeur Mae à paroi en acier satiné. Miroir Filolucido 50x80h cm avec lampe Spin in Corian® Dune Prima 20x40h cm et éclairage led orientable. Crochet Stone dans le même matériau.

Unico Freestanding-Waschbecken mit abgesenkt seitliche innere Ebene 50x36x85h cm aus Corian® Dune Prima. Mae Wandwaschtischmischer. Aus Satin-Edenstahl. Filolucido Spiegel 50x80h cm mit Spin Lampe aus Corian® Dune Prima 20x40h cm mit orientierbarer LED Beleuchtung. Stone Haken aus demselben Material.

Lavabo Único a suelo con estante lateral rebajado 50x36x85h cm en Corian® Dune Prima. Mezclador a pared Mae en acero inoxidable satinado. Espejo Filolucido 50x80h cm con lámpara LED Spin en Corian® Dune Prima 20x40h cm con iluminación orientable. Perchas Stone en el mismo material.

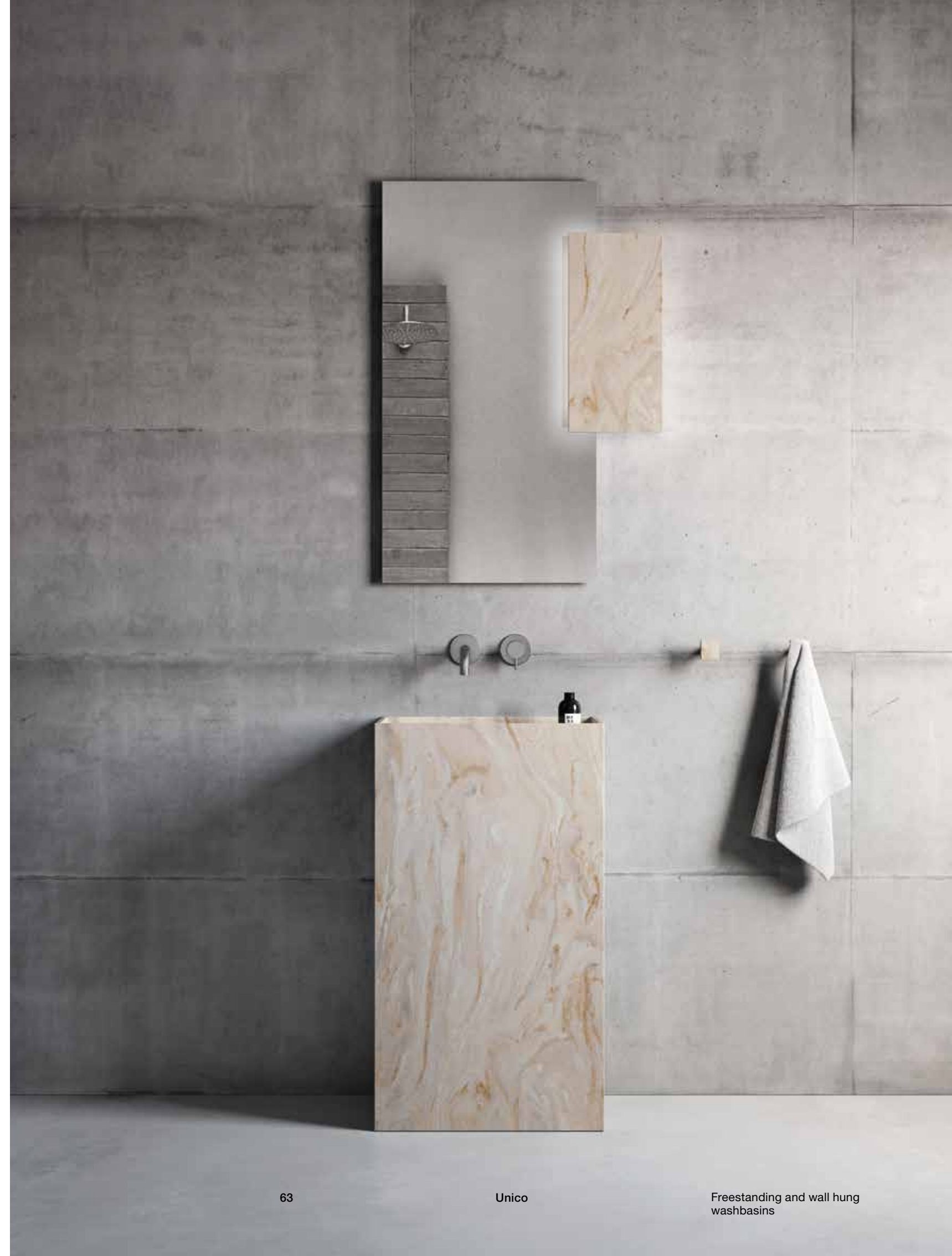
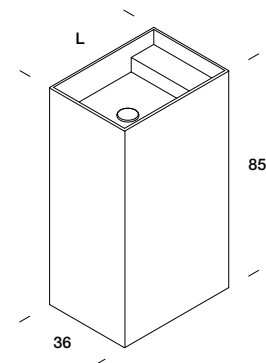



# Unico



**A terra**  
Freestanding



**Sospeso**  
Wall hung

## Overview

a terra  
freestanding

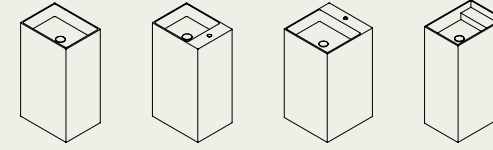

L 50-60 P 36-46 H 85



sospeso  
wall hung

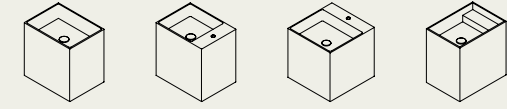

L 50-60 P 36-46 H 50



## Finiture | Finishes

Corian®

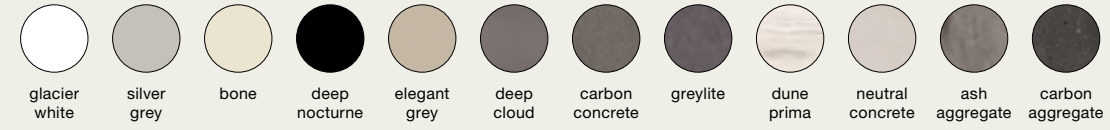

glacier white silver grey bone deep nocturne elegant grey deep cloud carbon concrete greylite dune prima neutral concrete ash aggregate carbon aggregate

## Accessori abbinabili | Combinable accessories



appendino  
hook

## Miscelatori abbinabili | Combinable mixers

Mae

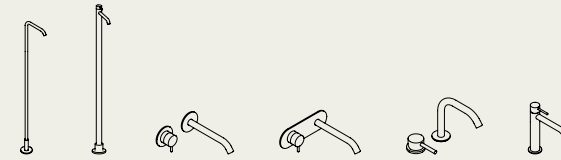

Drop



# Roll

Doppio lavabo Roll Ø 46x90h cm in marmo Nero Marquinia con doppia specchiera Reflex 90x5x72,5h cm con specchio Grigio ed illuminazione a LED perimetrale esterna. Appendini Moon in Corian® Deep Nocturne.

Double Roll washbasin Ø46x90h cm in black Marquinia marble with double mirror Reflex 90x5x72,5h cm with grey mirror and LED lighting. Moon hangers in Corian® Deep Nocturne.

Double lavabo Roll Ø46x90h cm en marbre noir Marquinia avec double miroir Reflex 90x5x72,5h cm, avec miroir gris et éclairage LED. Crochets Moon en Corian® Deep Nocturne.

Roll Doppel-Waschbecken Ø46x90h cm aus Nero Marquinia Marmor mit Reflex Doppel-Spiegel 90x5x72,5h cm mit grauem Spiegel und LED Raumbelichtung. Moon Haken aus Corian® Deep Nocturne.

Doble lavabo Roll Ø46x90h cm en mármol Negro Marquinia con doble espejo Reflex 90x5x72,5h cm con espejo Gris e iluminación a LED perimetral exterior. Perchas Moon en Corian® Deep Nocturne.

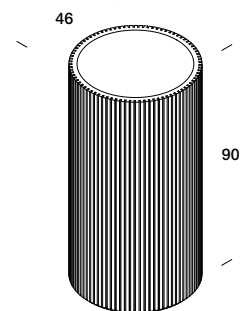

Lavabi a terra e sospesi

Roll



68

69

Roll

Freestanding and wall hung washbasins



A. Specchiera Reflex  
90-120-140-160x72,5h cm  
con specchio Grigio.  
B. Specchiera Reflex  
90-120-140-160x72,5h cm  
con specchio Bronzo.

A. A. Reflex mirror  
90-120-140-160x72,5h cm  
with grey mirror.  
B. Reflex mirror  
90-120-140-160x72,5h  
with bronze mirror.

A. Miroir Reflex  
90-120-140-160x72,5h cm  
Avec miroir gris.  
B. Miroir Reflex  
90-120-140-160x72,5h  
avec miroir bronze.

A. Reflex Spiegel  
90-120-140-160x72,5h cm  
mit grauen Spiegel.  
B. Reflex Spiegel  
90-120-140-160x72,5h  
mit bronze Spiegel.

A. Espejo Reflex  
90-120-140-160x72,5h cm  
con espejo gris.  
B. Espejo Reflex  
90-120-140-160x72,5h  
con espejo bronze.

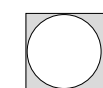

L 90-120 cm

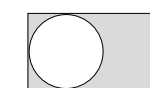

L 140-160 cm

# Roll



A terra  
Freestanding

## Overview

a terra  
freestanding

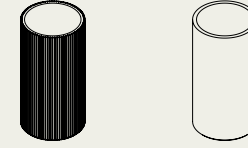

Ø 46 H 90

## Finiture | Finishes

Marmo | Marble

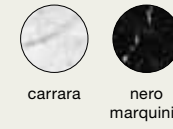

carrara

nero  
marquina

## Miscelatori abbinabili | Combinable mixers

Mae

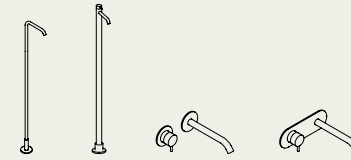

Drop



# Funnel

Lavabo Funnel Ø 45x90h cm in marmo Carrara e specchiera Halo Ø 72 cm con cornice in Corian® Deep Nocturne.  
Mensola e portasalviette Moon in Corian® Deep Nocturne.

Funnel washbasin Ø45x90h cm in Carrara marble and Halo mirror Ø72 cm with frame in Corian® Deep Nocturne. Shelf and towel holder Moon in Corian® Deep Nocturne.

Lavabo Funnel Ø45x90h cm en marbre Carrara et miroir Halo Ø72 cm avec cadre en Corian® Deep Nocturne. Porte-serviette et étagère Moon en Corian® Deep Nocturne.

Funnel Waschbecken Ø45x90h cm aus Carrara Marmor und Halo Spiegel Ø72 cm mit Rahmen aus Corian® Deep Nocturne. Moon Regal und Handtuchhalter aus Corian® Deep Nocturne.

Lavabo Funnel Ø45x90h cm en mármol Carrara y espejo Halo Ø72 cm con marco en Corian® Deep Nocturne. Estante y toallero Moon en Corian® Deep Nocturne.

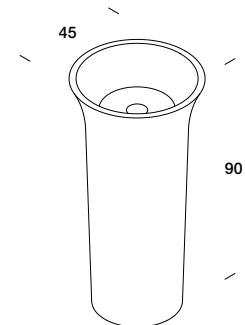



# Funnel



**A terra**  
Freestanding

## Overview

a terra  
freestanding



Ø 45 H 90

## Finiture | Finishes

**Marmo | Marble**

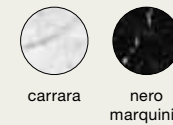

carrara    nero  
marquina

## Miscelatori abbinabili | Combinable mixers

**Mae**

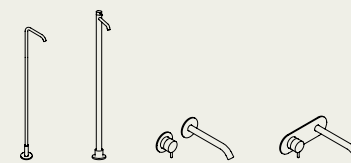

**Drop**







**Ruler**

Lampada a parete con illuminazione a led orientabile  
Wall hung lamp with adjustable led lighting

**Dimensioni | Dimensions**  
L 20 H 40 - L 20 H 20

**Finiture | Finishes**  
Corian®

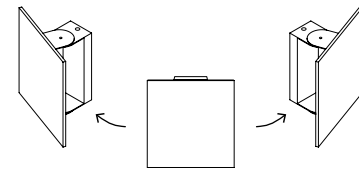

**Spin**

Lampada a parete con illuminazione a led orientabile  
Wall hung lamp with adjustable led lighting

**Dimensioni | Dimensions**  
Ø 20

**Finiture | Finishes**  
Corian®

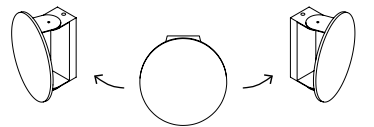

# Materiali

Materials

Corian®



Impiegato per la realizzazione di top, lavabi, piatti doccia, vasche, rivestimenti e accessori | Used for the realisation of tops, washbasins, shower trays, bathtubs, wall panelling and accessories | Employé pour plans, vasques, receveurs de douche, baignoire, revêtement mural et accessoires | Es wurde für die Herstellung von Platten, Waschbecken, Duschtassen und Badewannen entwickelt | Es empleado para la realización de encimeras, lavabos, platos de ducha, bañeras, revestimiento de paredes y accesorios

Corian® è un materiale non poroso, omogeneo e inalterabile alla luce, composto da  $\pm 1/3$  di resina acrilica (polimetilmetacrilato o PMMA) e da  $\pm 2/3$  di sostanze minerali. Il componente principale è il tri-idrato di alluminio (ATH), minerale derivato dalla bauxite, da cui si ricava l'alluminio. Dal 1967, anno della sua produzione, a oggi il Corian® ha dimostrato di essere un materiale resistente, versatile e igienico. Non essendo poroso, muffe e batteri non trovano appigli e non possono diffondersi nelle giunture o sotto la superficie. Inerte e non tossico, in condizioni normali di temperatura non emette gas. Quando viene bruciato rilascia ossidi di carbonio, il fumo è leggero e non contiene gas alogeni tossici. Per ulteriori informazioni consultare il sito internet: [www.dupont.it](http://www.dupont.it)

Corian® is a solid, non-porous, homogeneous surfacing material, composed of  $\pm 1/3$  acrylic resin (also known as Polymethyl Methacrylate or PMMA), and  $\pm 2/3$  of natural minerals. These minerals are composed of Aluminium Trihydrate (ATH) derived from bauxite, an ore from which aluminium is extracted. Since its birth in 1967 Corian® has proved to be really resistant, versatile and hygienic. Being a non-porous material, mold and bacteria cannot root nor spread themselves in the joints or under the surface. Corian® is non-toxic and inert. In normal temperature conditions is not emitting gas. If burnt releases mostly carbon monoxide and the light smoke does not have any halogen toxic gas. For further information on its composition, consult the website: [www.corian.uk](http://www.corian.uk)

Corian® est un matériel de revêtement homogène massif et non poreux, composé de  $\pm 1/3$  de résine acrylique (également connue sous le nom de Polyméthyle

Méthacrylate ou PMMA), et de  $\pm 2/3$  de minéraux naturels. Son composant principal est le Trihydrate de la bauxite (ATH), un minéral dérivé de la bauxite, le minéral dont on extrait l'aluminium. Depuis sa naissance en 1967, Corian® a démontré d'être vraiment résistant, versatile et hygiénique. Etant aussi un matériel homogène et non-poreux, moisissures et bactéries ne se déposent pas ni dans les joint et ni en dessous de la surface. Corian® est inerte et nontoxique. En condition de température normale, il génère aucune émission de gaz. En cas de combustion, il émet surtout des oxydes de carbone et le fumée est léger et contient pas des gaz halogènes toxiques. Pour plus d'information, consultez le site: [www.dupontdenemours.fr](http://www.dupontdenemours.fr)

Corian® ist ein massives, nicht poröses und homogenes Oberflächenmaterial aus  $\pm 1/3$  Acrylharz (auch als Polymethylmetacrylat oder PMMA bekannt) und  $\pm 2/3$  natürlichen Mineralien. Der Hauptbestandteil ist das Mineral Aluminiumhydroxid (ATH), das aus Bauxit (Aluminiumerz) gewonnen wird. Seit der Markteinführung im Jahr 1967 hat sich Corian® als langlebiges und nutzerfreundliches Material bewährt. Das porenlose, massive Corian® kann optisch fugenlos verarbeitet werden und verfügt deshalb über eine besonderes hygienische Oberfläche. Diese verhindert das Wachstum von Bakterien oder Schimmelpilzen. Corian® ist ein inaktives, nicht toxisches Material. Bei Normaltemperatur kommt es zu keiner Gasentwicklung. Wird es verbrannt, setzt der Werkstoff hauptsächlich Kohlendioxid frei. Der Rauch ist optisch hell und enthält keine toxischen halogenierten Gase. Informationen zur

Materialzusammensetzung entnehmen Sie bitte dem Corian® auf: [www.dupont.de](http://www.dupont.de)

Corian® es un material no poroso, homogéneo e inalterable a la luz, compuesto de  $\pm 1/3$  de resina acrílica (también conocida como Polimetilmetacrilato o PMMA) y  $\pm 2/3$  de minerales naturales. Su principal ingrediente es el mineral trihidrato de aluminio (ATH), un derivado de la bauxita que sirve de base para la producción de aluminio. Desde su introducción en 1967, Corian® ha demostrado ser un material resistente, versátil e higiénico. Como no es poroso, el moho y las bacterias no encuentran bodegas y no pueden propagarse en las articulaciones o debajo de la superficie. Corian® es un material inerte y no tóxico. Bajo condiciones normales de temperatura, no emite gases. Cuando se quema, principalmente desprende gas carbónico, el humo que genera es liviano y no contiene gases halogenados tóxicos. Para tener más información sobre la composición del material, consulte Corian® la página: [www.dupont.es](http://www.dupont.es)



non poroso  
non porous



igienico  
hygienic



termoformabile  
thermo-formable



facilmente ripristinabile  
easy restorable



assenza di giunzioni  
absence of joints



inalterabile alla luce  
lightfast

## Pulizia Corian®

### Uso e manutenzione Corian®

#### Manutenzione giornaliera A – B – C

Acqua ricca di calcare, sapone, minerali  
A – B – F – H

Graffio significativo, bruciatura di sigaretta,  
inchiostro, segni di penna A – B – C – E – H

Mercurocromo, sangue, profumo A – B – C –  
D – E – H

Smalto per unghie A – B – C – G – H

Ferro o ruggine A – B – C – G – H

Iodio A – B – C – E – H

Corian® colorato A – B – G

Agire sempre con movimenti circolari.  
Se non viene rimossa completamente  
risciacquando con acqua, la candeggina  
può scolorire il Corian®.

#### Metodi di pulizia

A. Rimuovere il residuo con un panno.

B. Sciacquare la superficie con acqua calda e  
asciugare con un panno morbido.

C. Usare un panno umido e una crema  
abrasiva leggera (es. Cif).

D. Usare una spugna, strofinare sulla  
macchia con un prodotto detergente a base  
di ammoniaca.

E. Usare una spugna, strofinare sulla  
macchia con candeggina diluita con

acqua, sciacquare più volte con acqua  
calda e asciugare con un panno morbido.

F. Usare una spugna e strofinare sulla  
macchia con un prodotto di pulizia  
anticalcare (tipo Viakal®) o aceto.  
Sciacquare più volte con acqua calda ed  
asciugare con un panno morbido.

G. Usare una spugna e strofinare sulla  
macchia con un prodotto privo di acetone.  
Sciacquare più volte con acqua calda ed  
asciugare con un panno morbido.

H. Se le macchie persistono, contattare  
Rexa Design (tel: 0434 593182).

Molti danni dovuti a urti, calore o prodotti  
chimici possono essere riparati solitamente  
sul luogo ridando integralmente alla  
superficie il suo aspetto originale, regolare,  
igienico.

## Cleaning methods for Corian®

### Corian® use and maintainance

#### For everyday cleaning A – B – C

Water rich of limestone, soaps, minerals  
A – B – F – H

Light scratch, cigarette burns, ink, marker  
pen A – B – C – E – H

Mercurochrome, blood, perfume  
A – B – C – D – E – H

Nail varnish spills A – B – C – G – H

Iron or rust A – B – C – G – H

Iodine A – B – C – E – H

Colored Corian® A – B – G

Always clean using circular motion.  
Bleach can discolour Corian® if not  
removed completely by rinsing with water  
afterwards.

#### Cleaning methods

A. Remove excess with a soft cloth.

B. Rinse surface with warm water and dry  
with a soft cloth.

C. Use a damp microfiber cloth and a light  
abrasive cream.

D. Use a microfiber cloth and wipe the  
stain with an ammonia detergent

E. Use a microfiber cloth and rub over the  
stain with some diluted bleach. Rinse  
several times with warm water and dry with  
a soft cloth.

F. Use a microfiber cloth and rub over the

stain with a standard household lime-scale  
remover (Viakal®, Lime-lite) or vinegar .  
Rinse several times with warm water and dry  
with a soft cloth.

G. Use a microfiber cloth and rub over the  
stain with a non-acetone based Nail varnish  
remover. Rinse several times with warm  
water and dry with a soft cloth.

H. If the stains persist, contact Rexa Design  
(tel: +39 0434 593182).

Most damages, including sever impact, heat  
or chemical damage, can usually be  
repaired on site to restore the original,  
smooth, hygienic solid surface integrity.



## Corian® Methodes de nettoyage

### Corian® utilisation et maintenance

#### Nettoyage quotidien A – B – C

Dépôt calcaire, savons, minéraux  
A – B – F – H

Égratignure importante, brûlure de  
cigarette, encre, marques de stylo  
A – B – C – E – H

Mercurochrome, sang, parfum  
A – B – C – D – E – H

Vernis à angle A – B – C – G – H

Fer ou rouille A – B – C – G – H

Iode A – B – C – E – H

Corian® coloré A – B – G

Nettoyez toujours en effectuant un  
mouvement circulaire. L'eau de javel risque  
de décolorer le Corian® si elle n'est pas  
ensuite rincée complètement à l'eau.

#### Methodes de nettoyage

A. Épongez avec un chiffon doux.

B. Rincez à l'eau chaude et séchez avec un  
chiffon doux.

C. Utilisez un chiffon humide et un détergent  
doux en crème (type Cif).

D. Utilisez une éponge et frottez la tâche  
avec un détergent ou un nettoyant pour  
surface dure à l'ammoniaque dilué (type Ajax  
ou Monsieur Propre).

E. Utilisez une éponge à récurer et frottez la

tâche avec un peu d'eau de javel dilué.  
Rincez plusieurs fois à l'eau chaude, puis  
séchez avec un chiffon doux.

F. Utilisez une éponge à récurer et frotter la  
tâche avec un produit anti-calcaire (type  
Viakal®) ou de vinaigre. Rincez plusieurs  
fois à l'eau chaude, puis séchez avec un  
chiffon doux.

G. Utilisez une éponge à récurer et frottez la  
tâche avec un dissolvant à ongles sans  
acétone. Rincez plusieurs fois à l'eau  
chaude, puis séchez avec un chiffon doux.

H. Si la tache persiste, contactez Rexa  
Design (tel: +39 0434 593182).

La plupart des dégâts, y compris les  
dommages importants dus à un choc, à la  
chaleur ou à des produits chimiques, sont  
habituellement réparables sur place pour  
redonner aux

## Corian® metodos de limpieza

### Corian® uso y mantenimiento

#### Para la limpieza cotidiana A – B – C

Cal de agua dura, jabon, minerales  
A – B – F – H

Rasguños significativos, quemaduras de  
cigarrillos, tinta, marcas de lápiz  
A – B – C – E – H

Sangre, vino, perfume A – B – C – D – E – H

Manchas de esmalte de uñas  
A – B – C – G – H

Hierro u oxidacion A – B – C – G – H

Yodo A – B – C – E – H

Corian® de colores A – B – G

Siempre limpie con movimientos circulares.  
La Lejia puede dejar manchas blancas en  
la superficie de Corian® si no se aclare con  
agua abundante.

#### Metodos de limpieza

A. Elimine manchas con un trapo suave.

B. Aclare la superficie con agua caliente y  
segue con un trapo suave.

C. aplique una crema ligeramente abrasiva  
(como Cif) con un paño mojado.

D. Con un estropajo que esté gastado frote  
la mancha con un producto para limpiar  
superficies sólidas a base de amoniaco.

E. Con un estropajo que esté gastado frote  
la mancha con un poco de lejia diluida.  
Aclare varias veces con agua caliente y

seque con un trapo suave.

F. Con un estropajo que esté gastado frote  
la mancha con un producto doméstico para  
eliminar los residuos de cal (Viakal®) o  
vinaigre. Aclare varias veces con agua  
caliente y seque con un trapo suave.

G. Con un estropajo que esté gastado frote  
la mancha con un detergente sin acetona.  
Aclare varias veces con agua caliente y  
seque con un trapo suave.

H. Si la mancha persiste, contacte Rexa  
Design (tel: +39 0434 593182).

La mayoría de los daños, incluso los  
causados por un golpe, el calor y productos  
químicos, se pueden reparar en el sitio de  
instalación.

## Corian® Reinigungsmethode

### Corian® gebrauch und wartung

#### Tägliche Reinigung A – B – C

Kalk-, Seifen- Mineralablagerungen  
A – B – F – I

Lilienpollen, Safran, leichte Kratzer,  
Zigarettenbrandfleck Tinte, Filzstift  
A – B – C – E – I

Mercurchrom, Blut, Rotwein, Parfum  
A – B – C – D – E – I

Nagellack A – B – C – G – I

Eisen oder Rost A – B – C – H – I

Jod A – B – C – E – I

\*Reinigen Sie die Oberfläche immer mit  
kreisenden Bewegungen  
\*\*Bleiche sofort mit Waser vollständig  
abspülen, andernfalls kann sich die Corian®  
Oberfläche verfärben.

#### Reinigungsmethode

A. Rückstände mit einem weichen Tuch  
entfernen.

B. Oberfläche mit warmen Wasser abspülen und  
mit einem weichen Tuch trockenwischen.

C. Ein feuchtes Tuch und eine milde  
Scheuermilch verwenden (z.B. Viss, Frosch  
Scheuermilch).

D. Mit einem abrasiven Scheuerschwamm  
(z.B. Scotch Brite®) und einem Reinigungs-mittel  
oder Reiniger für Massivoberflächen auf  
Ammoniakbasis (z.B. Ajax, Meister Proper,

General) über den Fleck reiben.

E. Mit einem abrasiver Scheuerschwamm  
(z.B. Scotch Brite®) und Haushaltsbleiche.  
Oberfläche mehrmals mit warmem Wasser  
abspülen und mit einem weichen Tuch  
trockenwischen.

F. Mit einem abrasiver Scheuerschwamm (z.B.  
Scotch Brite®) und einem standard-mäßigen  
Haushaltsmittel zur Entfernung von  
Kalkablagerungen (Sido) oder Essig über den  
Fleck reiben. Oberfläche mehrmals mit warmem  
Wasser abspülen und mit einem weichen Tuch  
trockenwischen.

G. Mit einem abrasiver Scheuerschwamm  
(z.B. Scotch Brite®) und einem acetonefreien  
Nagellackentferner über den Fleck reiben.  
Oberfläche mehrmals mit warmem Wasser  
abspülen und mit einem weichen Tuch  
trockenwischen.

H. Mit einem abrasiver Scheuerschwamm (z.B.  
Scotch Brite®) und einem Metallreiniger  
oder Rostentferner über den Fleck reiben.  
Oberfläche mehrmals mit warmem Wasser  
abspülen und mit einem weichen Tuch  
trockenwischen.

I. Wenn Flecken nicht entfernt werden können,  
setzen Sie sich mit Rexa Design (tel: +39 0434  
593182) in Verbindung.

Die meisten Schäden, ei nschließlich Schäden,  
die durch starke Schläge, Hitze oder Chemikalien  
verursacht wurden, können in der Regel vor Ort  
beseitigt werden. Die Oberfläche erhält dadurch  
ihre ursprüngliche, glatte, hygienische und  
massive Oberflächenbeschaffenheit zurück.



I Marmi e i Graniti selezionati offrono la possibilità di inserire in casa materiali naturali con toni abbinabili alle collezioni bagno. Il Marmo bianco di Carrara lascia trasparire un leggero grigio chiaro che si scurisce nelle venature. I marmi: Carrara, Grigio Veneto, Marquinia, Grigio Carnico ed Emperador sono caratterizzati da venature. Sulla superficie dei marmi sono presenti delle porosità. Il Nero Assoluto è un Granito naturale nero, resistente, con un bassissimo assorbimento e una texture uniforme contenente piccoli elementi in avorio.

Marbles and Granites selected offer the opportunity to incorporate natural materials at home with tones matching the bathroom collections. The white Carrara marble reveals a light gray which darkens in the grain. The marbles: Carrara, Grigio Veneto, Marquinia, Grigio Carnico and Emperador are characterized by their veins. Porosity can be seen on the surface of marbles. The Nero Assoluto is a natural black granite, resistant, with very low absorption and a uniform texture containing small items made of ivory.

Marbres et granits sélectionnés offrent la possibilité d'insérer chez soi des matériaux naturels avec des tons correspondants aux collections de salle de bains. Le marbre blanc de Carrare révèle un gris clair qui obscurcit dans le veinage: Le marbre: Carrara, Grigio Veneto, Marquinia, Grigio Carnico et Emperador se caractérisent par leurs veines. Sur la surface des marbres il est possible de percevoir la porosité. Le granit Nero Assoluto noir est un produit naturel, durable, avec une très faible absorption et une texture uniforme contenant de petites parties en ivoire.

Ausgewählte Marmors und

Lavabi a terra e sospesi

Materiali

Impiegato per la realizzazione dei top integrati e lavabi | Used for the realization of integrated top and washbasins | Utilisé pour la réalisation de plans intégrés et vasques | Wird für die Produktion von integrierten Waschbecken und Waschbecken verwendet | Se utiliza para la realización de la lavabo integrados y lavabos.

**Pulizia**

Pulire la superficie con acqua e detersivi neutri. I piani vengono trattati con un prodotto specifico (olio/idrorepellente) per migliorare le caratteristiche di resistenza all'assorbimento. È consigliabile trattare il piano con prodotti protettivi almeno una volta all'anno.

**Cleaning**

Clean the surface with water and mild detergents. The plans are treated with a specific product (oil/water-repellent) to improve the characteristics of resistance to the absorption. It is recommended to treat the top with protective products at least once a year.

**Nettoyage**

Nettoyer la surface avec de l'eau et des détergents doux. Les plans sont traités avec un produit spécifique (huile/produit hydrofuge) pour améliorer les caractéristiques de résistance à l'absorption. Il est recommandé de traiter le plan avec des produits de protection au moins une fois par année.

**Reinigung**

Reinigen Sie die Oberfläche mit Wasser und einem milden Reinigungsmittel. Die Platten werden mit einem bestimmten Produkt (Öl/Dichtmittel) behandelt, um die Eigenschaften der Beständigkeit gegen die Absorption zu verbessern. Es wird empfohlen, die Platte mit Schutzprodukten mindestens einmal im Jahr zu behandeln.

**Limpieza**

Limpiar la superficie con agua ydetergentes suaves. Las encimeras son tratadas con un producto específico (aceite/sellante) para mejorar las características de resistencia a la absorción. Se recomienda tratar la encimera con productos de protección al menos una vez al año.



poroso  
porous



resistente  
resistant



Impiegato per la realizzazione del lavabo Discovolante | Used for the realization of Discovolante basin | Utilisé pour la réalisation du lavabo Discovolante | Wird für die Herstellung des Discovolante Waschbecken verwendet | Es empleado para la realización de lavabo Discovolante en vidrio.

Vetro che si ottiene tramite la solidificazione di un liquido viscoso, ottenuto per fusione di minerali cristallini. Il vetro è temperato e trattato con anticalcare. Colorato in pasta, grazie all'aggiunta di elementi naturali che ne caratterizzano il colore.

Glass is obtained through the solidification of a viscous liquid, obtained by melting of crystalline minerals. The glass is tempered and treated with a descaler. Paste colored thanks to the addition of natural elements which characterizes the color.

Verre obtenu par la solidification d'un liquide visqueux et par fusion de minéraux cristallins. Le verre est trempé et traité avec anticalcaire. Coloré en pâte, grâce à l'ajout d'éléments naturels qui caractérisent la couleur.

Glas, das durch Verfestigung einer zähen Flüssigkeit gewonnen wird, die durch Schmelzen von kristallinen Mineralien gewonnen wird. Glas ist gehärtet und mit Kalklösend behandelt. Farblich im Teig, durch den Zusatz natürlicher Elemente, die seine Farbe charakterisieren.

Vidrio que se obtiene mediante la solidificación de un líquido viscoso, obtenido por fusión de minerales cristalinos. El vidrio es templado y tratado con anticalcare. Coloreado en pasta, gracias a la adición de elementos naturales que caracterizan el color.

**Pulizia**

Utilizzare i normali prodotti per la pulizia del vetro avendo cura di risciacquare e asciugare bene.

**Cleaning**

Use normal glass cleaning products taking care to rinse and dry well.

**Nettoyage**

Utilisez des produits de nettoyage pour verre normaux en prenant soin de bien rincer et bien sécher.

**Reinigung**

Zur Reinigung nur neutrale Reinigungsmittel und keinen aggressiven Entkalker verwenden.

**Limpieza**

Use productos de limpieza de vidrio normales teniendo cuidado de enjuagar y secar bien.



inalterabile alla luce  
lightfast



riciclabile  
recyclable

127

Materials

Freestanding and wall hung washbasins

**Credits**

Art direction

Monica Graffeo

Render

Studio Iride

Photolithography

Luce group

Print

Grafiche Italprint

**Rexa Design S.r.l.**

Via Maniago, 57/A 33080  
San Quirino PN – Italy

T +39 0434 593182  
F +39 0434 921579

[info@rexadesign.it](mailto:info@rexadesign.it)  
[www.rexadesign.it](http://www.rexadesign.it)

rexadesign.it  
T +39 0434 593182

**REXA**  
DESIGN