

Vision

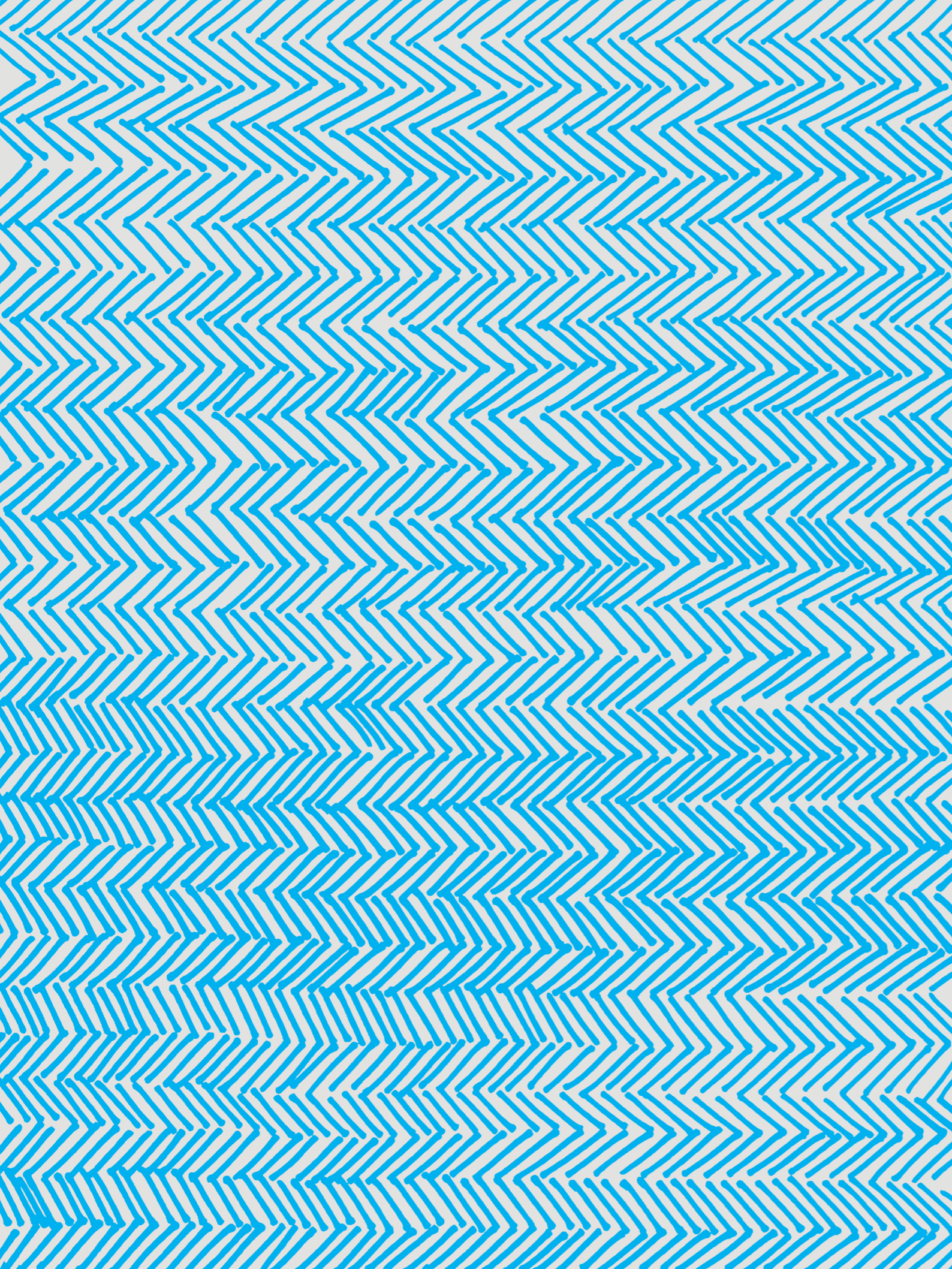

REXA



Vision

design Monica Graffeo

REXA

An introduction



IT Una collezione concepita come uno spazio in cui sensorialità e funzionalità si uniscono e dialogano in modo armonioso.

In Vision i protagonisti sono elementi monoliti: moduli di contenimento che diventano volumi sospesi scolpiti, e pareti materiche che inglobano la parte tecnica e funzionale, celandola, per portare alla luce l'acqua attraverso gli elementi fonte e gli oggetti che la circondano.

EN A collection conceived as a space where sensoriality and functionality come together and interact harmoniously.

The protagonists in Vision are monolithic elements: storage units that become sculpted suspended modules and textured walls that incorporate the technical and functional part, hiding it, to enhance the water concept through the spring elements and the objects that surround it.

FR Une collection conçue comme un espace dans lequel sensorialité et fonctionnalité se rencontrent et dialoguent de manière harmonieuse.

Dans Vision, les protagonistes sont des éléments monolithiques, des modules de rangement qui

Monica Graffeo: Vision nasce dall'idea di trasformare la parete in un contenitore di funzioni, celando vani tecnici attrezzati e integrando i lavabi, che diventano fonti disegnate per portare alla luce il mondo dell'acqua e dei suoi rituali.

Monica Graffeo: The project was born from the idea of transforming the wall into a functional storage, hiding equipped technical compartments and integrating the washbasin, which become a sort of fountain designed to enhance the world of water and its rituals.

Monica Graffeo: Vision est née de l'idée de transformer le mur en un conteneur de fonctions, dissimulant des compartiments techniques équipés et intégrant les lavabos, qui deviennent des sources destinées à mettre en lumière le monde de l'eau et ses rituels.

Monica Graffeo: Vision entsteht durch die Idee, die Wand in einen Behälter für die Funktionen zu verwandeln, indem technische Räume verborgen und Waschbecken integriert werden, die sich in Quellen verwandeln, die entworfen wurden, um die Welt des Wassers und seiner Rituale zu enthüllen.

Monica Graffeo: Vision nace de la idea de transformar la pared en un contenedor de funciones, ocultando vanos técnicos equipados y incorporando los lavabos, que se convierten en fuentes diseñadas para traer a la luz el mundo del agua y de sus rituales.

deviennent des volumes sculptés suspendus, et des parois des matériaux qui intègrent la partie technique et fonctionnelle, la cachent, pour mettre l'eau en lumière à travers les éléments sources et les objets qui l'entourent.

DE Eine als Raum konzipierte Kollektion, in der Sinnlichkeit und Funktionalität harmonisch miteinander in Verbindung stehen.

In Vision sind die Protagonisten monolithische Eindämmungsmodule, die zu suspendierten Klumpen werden, und Materialwände, die den technischen und funktionellen Teil enthalten und verbergen, um das Wasser durch die Quelle-Elemente und der Objekte, die es umgeben, ans Licht zu bringen.

ES Una colección concebida como un espacio en el que sensorialidad y funcionalidad se unen y hablan de forma armoniosa.

En Vision los protagonistas son elementos monolíticos, módulos contenedores que se convierten en volúmenes suspendidos esculpidos, y paredes de materia que incorporan la parte técnica y funcional, ocultándola, para sacar el agua a la luz a través de los elementos fuente y los objetos que la rodean.

An introduction What is Vision

1.

Verticalità che contiene e regala volume allo spazio circostante.
Vertical storage that confers volume to the surrounding space.
Le rangement vertical donne du volume à l'espace environnant.
Höhe, die Volumen in den umliegenden Raum einbezieht und verschenkt.
Verticalidad que contiene y regala volumen al espacio circundante.

3.

Esperienza d'uso all'insegna di una funzionalità espressa solo all'occorrenza.
User experience where functionality is expressed only when necessary.
C'est une expérience d'utilisation où la fonctionnalité n'est exprimée que lorsque cela est nécessaire.
Bedienungserfahrung mit Funktionalität, die nur bei Bedarf zum Ausdruck kommt.
Experiencia de uso con funcionalidad expresada sólo cuando es necesario.

2.

Architetture monolitiche dall'effetto scenografico, essenziale.
Monolithic architectures with an essential, scenic effect.
Il propose des architectures monolithiques avec un effet scénographique, essentiel.
Monolithische Architekturen mit wesentlicher Bühnenwirkung.
Arquitecturas monolíticas de efecto escenográfico, esencial.

4.

Grande capacità di contenimento, compatibile anche con gli spazi più contenuti.
Large storage capacity, compatible with even smallest spaces.
Grande capacité de rangement, compatible même avec les plus petits espaces.
Grosse Auffangkapazität, kompatibel mit kleineren Räumen
Gran capacidad de contención, compatible también con los espacios más contenidos.

Modello registrato / IT Registered design

Rexa Design ha scelto di proteggere Vision come Modello Registrato a tutela dell'unicità del progetto.

Rexa Design has chosen to protect Vision as a Registered Model to preserve the uniqueness of the project.

Rexa Design a choisi de protéger Vision comme modèle enregistré pour protéger l'unicité du projet.

Rexa Design hat sich dafür entschieden, Vision als eingetragenes Modell zu schützen, um die Einzigartigkeit des Projekts zu wahren.

Rexa Design ha elegido proteger Vision como Modelo Registrado para proteger la singularidad del proyecto.

2021 ADA Winner



archiproducts
DESIGN AWARDS
WINNER 2021

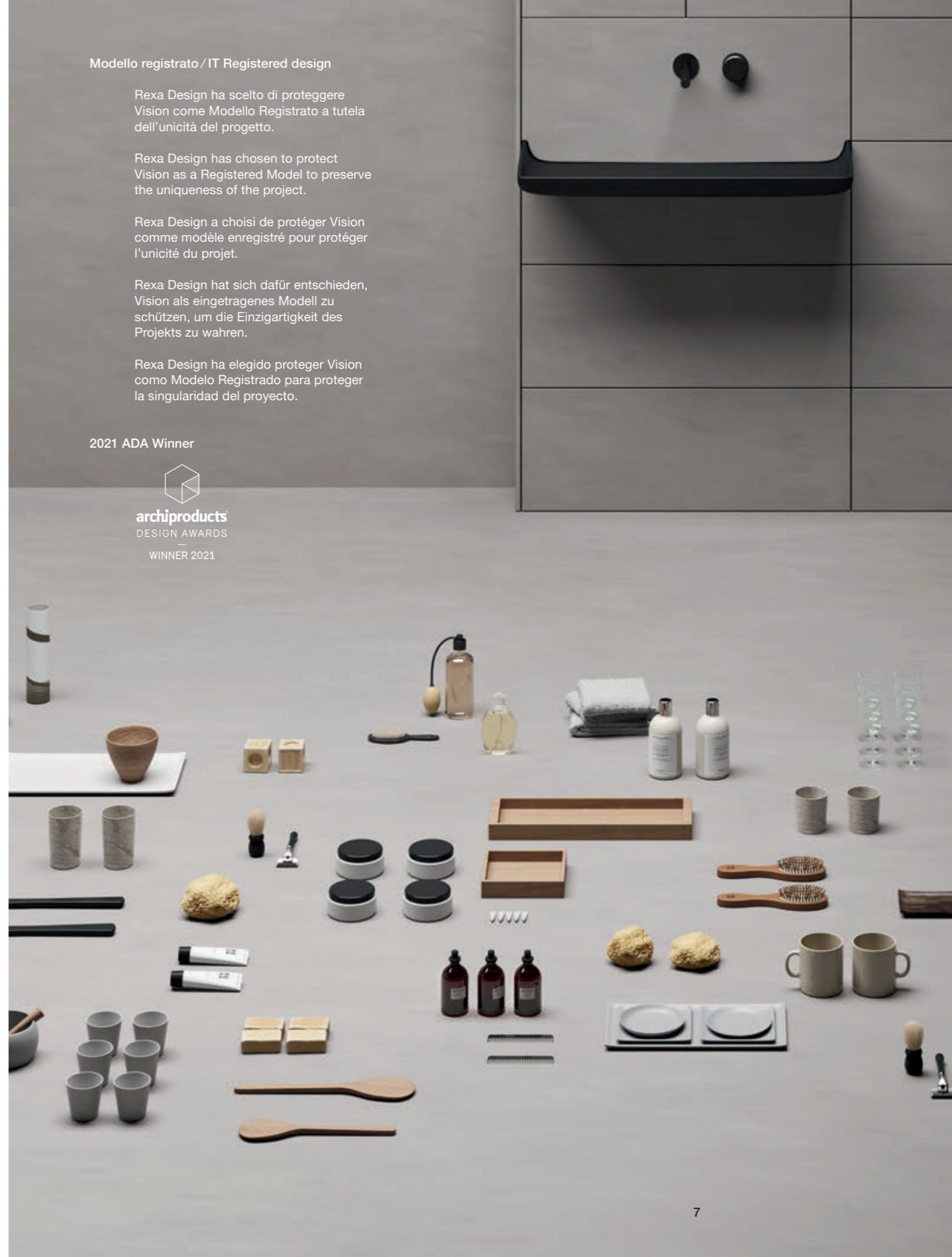

Vision Catalogue Contents

- 13 Spaces
 - Dive into materials
 - Natural essentiality
 - A modern way to live
 - Architectural tension
 - Embrace new classics

- 77 More Compositions

- 89 Elements

- 105 Materials, Colours
Moods

- 114 About Monica Graffeo

- 116 Inside Rexa

- 118 Spaces Index

Spaces

Space 1

Dive into materials



Composition 1

- IT Colonna, modulo lavabo con specchiera e colonne 80x18x240h cm con tamponamento superiore 30h cm, finitura Corian® Carbon Aggregate. Lavabo in Shark Nero 80x35x6,5h cm. Rivestimento a pavimento, vasca *Unico Maxi* e piatto doccia *Unico* in Corian® Carbon Aggregate.
- EN Column, washbasin module with mirror and column units 80x18x240h cm with upper infill panel 30h cm, Corian® Carbon Aggregate finish. Washbasin 80x35x6,5h cm in Shark Nero. Floor covering panels, *Unico Maxi* bathtub and *Unico* shower tray in Corian® Carbon Aggregate.
- FR Colonne, module lavabo avec miroir et colonnes 80x18x240h cm avec tamponnement supérieur 30h cm, finition Corian® Carbon Aggregate. Lavabo en Shark Nero 80x35x6,5h cm. Revêtement au sol, baignoire *Unico Maxi* et receveur de douche *Unico* en Corian® Carbon Aggregate.
- DE Säulenschrank, Waschtischmodul mit Spiegel und Säulenschränken 80x18x240h cm mit Abdeckplatte 30h cm, Ausführung Corian® Carbon Aggregate. Waschbecken 80x35x6,5h cm aus Shark Nero. Bodenverkleidung, *Unico Maxi*-Badewanne und *Unico*-Duschwanne aus Corian® Carbon Aggregate.
- ES Columna, mueble lavabo con espejo y columnas 80x18x240h cm y relleno superior 30h cm, acabado Corian® Carbon Aggregate. Lavabo en Shark Nero 80x35x6,5h cm. Revestimiento a suelo, bañera *Unico Maxi* y plato de ducha *Unico* en Corian® Carbon Aggregate.





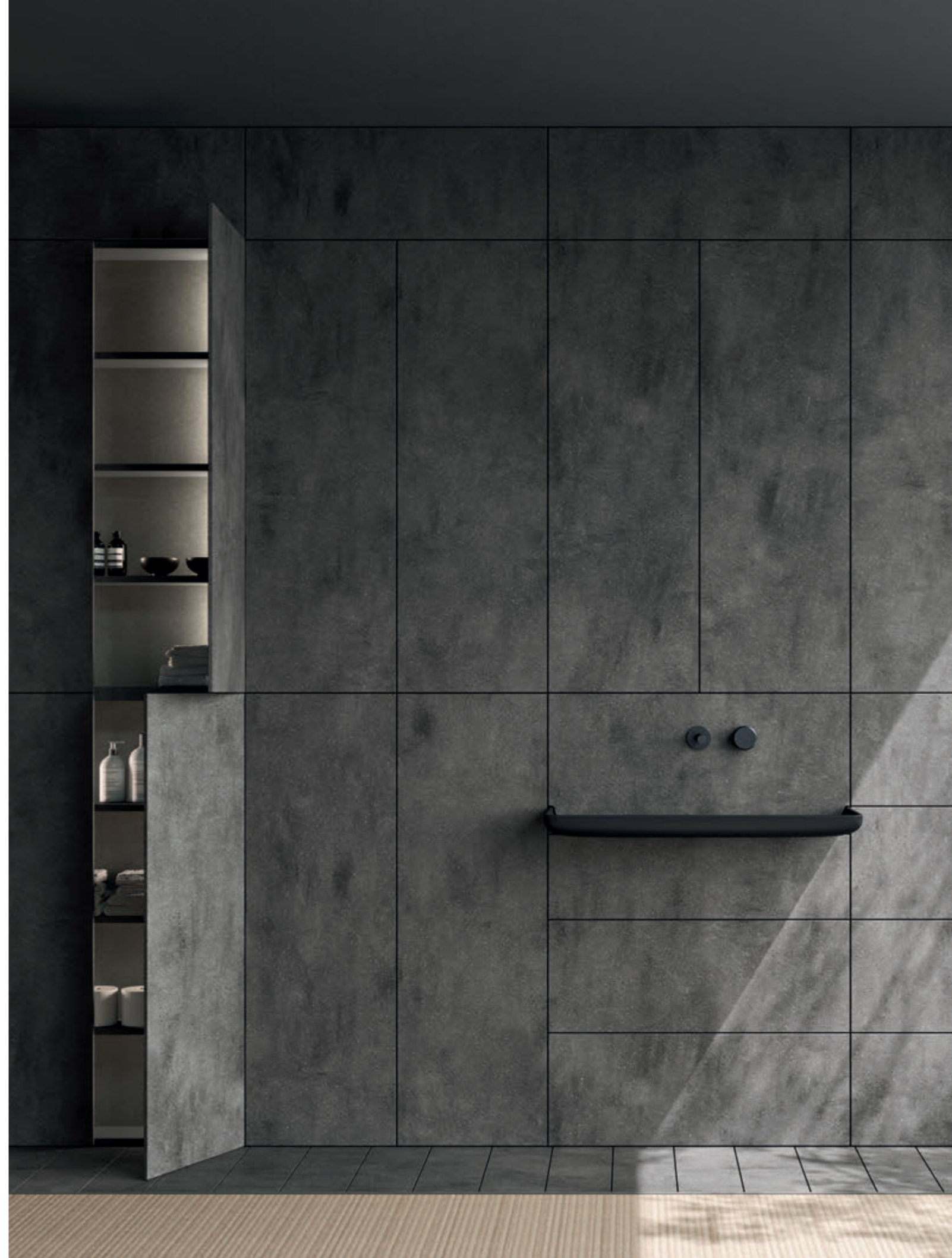



Space 2

Natural essentiality



Composition 2

- IT Modulo lavabo con specchiera e modulo arredo 80x18x240h cm finitura Eco.malta Beige Chiaro. Lavabo in Shark Nero 80x35x6,5h cm.
- EN Washbasin module with mirror and simple module 80x18x240h cm Beige Chiaro Eco.malta finish. Washbasin 80x35x6,5h cm in Shark Nero.
- FR Module lavabo avec miroir et module rangement 80x18x240h cm en finition Eco.malta Beige Chiaro. Lavabo en Shark Nero 80x35x6,5h cm.
- DE Waschbeckenmodul mit Spiegel und Möbelmodul 80x18x240h cm in der Ausführung Eco.malta Light Beige. Waschbecken 80x35x6,5h aus Shark Nero.
- ES Mueble lavabo con espejo y módulo auxiliar 80x18x240h cm en acabado Eco.malta Beige Chiaro. Lavabo en Shark Nero 80x35x6,5h cm.





Composition 3

- IT Moduli lavabo e moduli arredo 60x18x60h cm finitura Fenix® Grigio Efeso. Lavabo in Marmo Carrara 60x35x6,5h cm. Specchiere Halo Ø 72 cm con cornice in Corian® Glacier White.
- EN Washbasin modules and simple modules 60x18x60h cm Fenix® Grigio Efeso finish. Carrara Marble washbasin 60x35x6,5h cm. Halo mirrors Ø 72 cm with Corian® Glacier White frame.
- FR Modules lavabo et modules rangement 60x18x60h cm finition Fenix® Grigio Efeso. Lavabo en Marbre Carrara 60x35x6,5h cm. Miroirs Halo 72 cm avec cadre en Corian® Glacier White.
- DE Waschbecken und Möbelmodule 60x18x60h cm in der Ausführung Fenix® Grigio Efeso. Waschbecken 60x35x6,5h cm aus Carrara Marmor. Halo Spiegel Ø 72 cm mit Rahmen aus Corian® Glacier White.
- ES Mueble lavabo y módulo auxiliar 60x18x60h cm acabado Fenix® Grigio Efeso. Lavabo en Marmol Carrara 60x35x6,5h cm. Espejos Halo Ø 72 cm con marco en Corian® Glacier White.









Space 3

A modern way to live

Composition 4

- IT Modulo lavabo e moduli arredo 80x18x120h cm finitura Corian® Neutral Concrete. Lavabo in Korakril™ Blend Ice White 80x35x14h cm. Rivestimento a parete e piatto doccia *Unico* in Corian® Neutral Concrete.
- EN Washbasin module and simple modules 80x18x120h cm Corian® Neutral Concrete finish. Washbasin 80x35x14h cm in Korakril™ Blend Ice White. Wall paneling and *Unico* shower tray in Corian® Neutral Concrete.
- FR Module lavabo et modules rangement 80x18x120h cm finition Corian® Neutral Concrete. Lavabo en Korakril™ Blend Ice White 80x35x14h cm. Revêtement mural et receveur de douche *Unico* en Corian® Neutral Concrete.
- DE Waschtischmodul und Möbelmodule 80x18x120h cm in der Ausführung Corian® Neutral Concrete. Waschbecken 80x35x14h cm aus Korakril™ Blend Ice White. Wandverkleidung und *Unico*-Duschwanne aus Corian® Neutral Concrete.
- ES Mueble lavabo y módulo auxiliar 80x18x120h cm acabado Corian® Neutral Concrete. Lavabo en Korakril™ Blend Ice White 80x35x14h cm. Revestimiento de pared y plato de ducha *Unico* en Corian® Neutral Concrete.







Composition 5

- IT Modulo lavabo 60x18x120h cm finitura Corian® Silver Birch con lavabo in Korakril™ Blend Ice White 60x35x6,5h cm.
- EN Washbasin module 60x18x120h cm Corian® Silver Birch finish with washbasin 60x35x6,5h cm in Korakril™ Blend Ice White.
- FR Module lavabo 60x18x120h cm finition Corian® Silver Birch avec lavabo en Korakril™ Blend Ice White 60x35x6,5h cm.
- DE Waschtischmodul 60x18x120h cm in der Ausführung Corian® Silver Birch mit Waschbecken 60x35x6,5h cm aus Korakril™ Blend Ice White.
- ES Mueble lavabo 60x18x120h cm acabado Corian® Silver Birch con lavabo en Korakril™ Blend Ice White 60x35x6,5h cm.







Space 4

Architectural tension





Composition 6

- IT Moduli arredo 60x18x60h cm finitura Fenix® Oro Cortez. Specchiere contenitive 60x18x90h cm. Lavabo a terra *Discovolante* in Corian® Deep Nocturne Ø 37x90h cm con piano in vetro Grigio. Appendino in acciaio nero.
- EN Simple modules 60x18x60h cm Fenix® Oro Cortez finish. Mirrored cabinets 60x18x90h cm. Freestanding *Discovolante* washbasin Ø 37x90h cm in Corian® Deep Nocturne with Gray glass shelf. Black steel hanger.
- FR Modules rangement 60x18x60h cm finition Fenix® Oro Cortez. Armoire miroir 60x18x90h cm. Lavabo au sol *Discovolante* en Corian® Deep Nocturne Ø 37x90h cm avec plateau en verre Gris. Crochet en acier noir.
- DE Möbelmodule 60x18x60h cm in der Ausführung Fenix® Oro Cortez. Aufbewahrungsspiegel 60x18x90h cm. Bodenstehender Waschtisch *Discovolante* aus Corian® Deep Nocturne Ø 37x90h cm mit Glasplatte Grau. Aufhänger aus schwarzem Stahl.
- ES Módulos auxiliares 60x18x60h cm cm acabado Fenix® Oro Cortez. Espejos contenedores 60x18x90h cm. Lavabo a suelo *Discovolante* en Corian® Deep Nocturne Ø 37x90h cm con encimera de vidrio Gris. Percha de acero negro.







Composition 7

- IT Moduli arredo 80x18x60h cm finitura Laccato lucido Grafite.
Modulo lavabo finitura Fenix® Nero Ingo. Lavabo in Marmo Nero Marquinia 80x35x6,5h cm. Specchiere contenitive 120x18x40h cm con anta specchio a ribalta.
- EN Simple modules 80x18x60h cm Grafite glossy lacquered finish.
Washbasin module Fenix® Nero Ingo finish. Washbasin 80x35x6,5h cm in Nero Marquinia marble. Mirrored cabinets 120x18x40h cm with flap mirror door.
- FR Modules rangement 80x18x60h cm finition Laqué brillant Grafite.
Module lavabo finition Fenix® Nero Ingo. Lavabo en Marbre Nero Marquinia 80x35x6,5h cm. Armoire miroir 120x18x40h cm avec porte miroir à abattant.
- DE Möbelmodule 80x18x60h cm Grafite glänzend lackiert.
Waschtischmodul in der Ausführung Fenix® Nero Ingo.
Waschbecken 80x35x6,5h cm aus Nero Marquinia Marmor.
Ablagespiegel 120x18x40h cm mit abklappbarer Spiegeltür.
- ES Módulos auxiliares 80x18x60h cm acabado lacado brillo Grafite.
Mueble lavabo en acabado Fenix® Nero Ingo. Lavabo de Mármol Nero Marquinia 80x35x6,5h cm. Espejos contenedores 120x18x40h cm con puerta abatible.







Space 5

Embrace new classics

Composition 8

- IT Modulo lavabo con specchiera e colonna 80x18x240h cm finitura Gres Bianco Statuario matt. Lavabo in Shark Nero opaco. Pensili 80x18x120h cm finitura Laminam Bianco Statuario matt. Base *Moode* 140x43x25h cm in Laccato opaco Grafite. Vasca *Unico Maxi* in Corian® Deep Nocturne. Moduli arredo 80x18x240h cm in Noce Canaletto Cannettato.
- EN Washbasin module with mirror and column 80x18x240h cm Bianco Statuario matt Gres finish. Washbasin in Shark Nero matt. Wall units 80x18x120h cm in Laminam Bianco Statuario matt finish. *Moode* unit 140x43x25h cm Grafite matt lacquered. *Unico Maxi* bathtub in Corian® Deep Nocturne. Simple modules 80x18x240h cm in American ribbed walnut.
- FR Module lavabo avec miroir et colonne 80x18x240h cm finition Grès Bianco Statuario matt. Lavabo en Shark Nero mat. Unités murales suspendues 80x18x120h cm finition Laminam Bianco Statuario matt. Base *Moode* 140x43x25h cm en Laqué mat Grafite. Baignoire *Unico Maxi* en Corian® Deep Nocturne. Modules rangement 80x18x240h cm en Noyer Canaletto Cannetté.
- DE Waschtischmodul mit Spiegel und Säulenschrank 80x18x240h cm Ausführung Gres Bianco Statuario matt. Waschtischbecken aus Shark Nero matt. Hängeschränke 80x18x120h cm in der Ausführung Laminam Bianco Statuario matt. *Moode* Unterschrank 140x43x25h cm Grafite matt lackiert. *Unico Maxi*-Badewanne aus Corian® Deep Nocturne. Möbelmodule 80x18x240h cm Canaletto Nussbaum gerippt.
- ES Mueble lavabo con espejo y columnas 80x18x240h cm, acabado Laminam Bianco Statuario mate. Lavabo en Shark Nero mate. Colgantes 80x18x120h cm en acabado Laminam Bianco Statuario mate. Módulo *Moode* 140x43x25h cm en lacado opaco Grafite. Bañera *Unico Maxi* en Corian® Deep Nocturne. Módulos auxiliares 80x18x240h cm en Nogal Canaletto encanalado.









More Compositions

Composition 9

VARIATION – Composition 2, p 26



- IT Modulo lavabo con specchiera e modulo arredo 60x18x180h cm finitura Fenix® Verde Comodoro. Lavabo in Marmo Verde Alpi 60x35x6,5h cm.
- EN Washbasin module with mirror and simple module 60x18x180h cm Fenix® Verde Comodoro finish. Unit with washbasin 60x35x6,5h cm in Verde Alpi marble.
- FR Module lavabo avec miroir et module rangement 60x18x180h cm Fenix® Verde Comodoro. Lavabo en Marbre Verde Alpi 60x35x6,5h cm.
- DE Waschtischmodul mit Spiegel und Möbelmodul 60x18x180h cm in der Ausführung Fenix® Verde Comodoro. Unterschrank mit Waschbecken 60x35x6,5h cm aus Verde Alpi Marmor.
- ES Mueble lavabo con espejo y módulo mobiliario 60x18x180h cm acabado Fenix® Verde Comodoro. Lavabo de mármol Verde Alpi 60x35x6,5h cm.

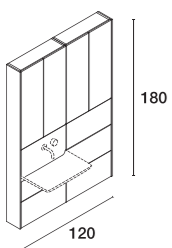

Composition 10

VARIATION – Composition 6, p 52



- IT Moduli arredo 60x18x90h cm finitura Laccato opaco Grigio Foresta. Base *Moode* 240x53x40h cm finitura Fenix® Grigio Bromo con top in finitura e lavabo in appoggio *Moode* in Corian® Deep Nocturne. Specchiera *Reflex* 120x72,5h cm.
- EN Simple modules 60x18x90h cm Grigio Foresta matt lacquered. *Moode* unit 240x53x40h cm Fenix® Grigio Bromo finish with top in Corian® and *Moode* overcounter washbasin in Corian® Deep Nocturne. *Reflex* mirror 120x72,5h cm.
- FR Modules rangement 60x18x90h cm finition Laqué mat Grigio Foresta. Base *Moode* 240x53x40h cm finition Fenix® Grigio Bromo avec top dans la même finition et lavabo à poser *Moode* en Corian® Deep Nocturne. Miroir *Reflex* 120x72,5h cm.
- DE Möbelmodule 60x18x90h cm, Grigio Foresta matt lackiert. *Moode* Unterschrank 240x53x40h cm in der Ausführung Fenix® Grigio Bromo mit Platte in der gleichen Ausführung und *Moode* Aufsatzwaschbecken aus Corian® Deep Nocturne. *Reflex* Spiegel 120x72,5h cm.
- ES Módulos auxiliares 60x18x90h cm acabado lacado mate Grigio Foresta. Módulo *Moode* 240x53x40h cm acabado Fenix® Grigio Bromo con encimera en Corian® y lavabo en apoyo *Moode* en Corian® Deep Nocturne. Espejo *Reflex* 120x72,5h cm.

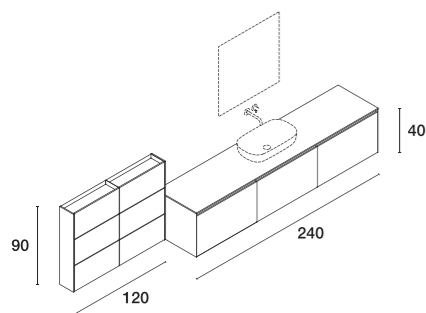

Composition 11

VARIATION – Composition 3, p 30



- IT Moduli arredo 60x18x120h cm in finitura laccato opaco Rosa Polvere e modulo lavabo in Corian® Carbon Aggregate. Lavabo Shark Nero 60x35x14h cm. Specchiera Rettangolo con cornice in Corian® Deep Nocturne.
- EN Simple modules 60x18x120h cm Rosa Polvere matt lacquered and washbasin module in Corian® Carbon Aggregate. Washbasin 60x35x14h cm in Shark Nero. Rettangolo mirror with frame in Corian® Deep Nocturne.
- FR Modules rangement 60x18x120h cm en finition laqué mat Rosa Polvere et module lavabo en Corian® Carbon Aggregate. Lavabo Shark Nero 60x35x14h cm. Miroir Rectangle avec cadre en Corian® Deep Nocturne.
- DE Möbelmodule 60x18x120h cm Rosa Polvere matt lackiert und Waschtischmodul aus Corian® Carbon Aggregate. Waschtisch 60x35x14h cm aus Shark Nero. Rechteckiger Spiegel mit Rahmen aus Corian® Deep Nocturne.
- ES Módulos auxiliares 60x18x120h cm en acabado lacado mate Rosa Polvere y mueble lavabo en Corian® Carbon Aggregate. Lavabo en Shark Nero 60x35x14h cm. Espejo rectangular con marco en Corian® Deep Nocturne.

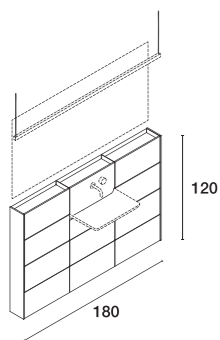

Composition 12

VARIATION – Composition 5, p 44



- IT Modulo lavabo con specchiera 80x18x180h cm finitura Fenix® Nero Ingo e lavabo in Shark Nero 80x35x6,5h cm. Modulo arredo 80x18x180h cm finitura Noce Canaletto Cannettato. Portasalviette *Moon* in Corian® Deep Nocturne.
- EN Washbasin module with mirror 80x18x180h cm Fenix® Nero Ingo finish and washbasin 80x35x6,5h cm in Shark Nero. Simple module 80x18x180h cm American ribbed walnut finish. *Moon* towel holder in Corian® Deep Nocturne.
- FR Module lavabo avec miroir 80x18x180h cm finition Fenix® Nero Ingo et lavabo en Shark Nero 80x35x6,5h cm. Module rangement 80x18x180h cm finition Noyer Canaletto Cannetté. Porte-serviette *Moon* en Corian® Deep Nocturne
- DE Waschtischmodul mit Spiegel 80x18x180h cm in der Ausführung Fenix® Nero Ingo und Waschtisch 80x35x6,5h cm aus Shark Nero. Möbelmodul 80x18x180h cm Canaletto Nussbaum gerippt. *Moon* Handtuchhalter aus Corian® Deep Nocturne.
- ES Mueble lavabo con espejo 80x18x180h cm acabado Fenix® Nero Ingo y lavabo en Shark Nero 80x35x6,5h cm. Módulos modulo auxiliar 80x18x180h cm en Nogal Canaletto encañado. Toallero *Moon* en Corian® Deep Nocturne.

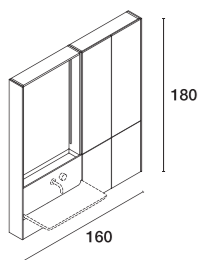

Composition 13

VARIATION – Composition 4, p 38



- IT Modulo lavabo e modulo arredo 60x18x90h cm in finitura Eco.malta Grafite. Lavabo 60x35x6,5h cm in Shark Zenzero. Moduli arredo con ante battenti 60x18x90h cm in laccato opaco Zenzero. Specchiera *Filolucido* 240x90h cm.
- EN Washbasin module and simple module 60x18x90h cm Eco.malta Grafite finish. Washbasin 60x35x6,5h cm in Shark Zenzero. Simple modules with hinged doors 60x18x90h cm Zenzero matt lacquered. *Filolucido* mirror 240x90h cm.
- FR Module lavabo et Module rangement 60x18x90h cm en finition Eco.malta Grafite. Lavabo 60x35x6,5h cm en Shark Zenzero. Modules rangement avec portes battantes 60x18x90h cm en laqué mat Zenzero. Miroir *Filolucido* 240x90h cm.
- DE Waschbeckenmodul und Möbelmodul 60x18x90h cm in der Ausführung Eco.malta Grafite. Waschbecken 60x35x6,5h cm aus Shark Zenzero. Möbelmodule mit Flügeltüren 60x18x90h cm Zenzero matt lackiert. *Filolucido* Spiegel 240x90h cm.
- ES Mueble lavabo y módulo auxiliar 60x18x90h cm en acabado Eco.malta Grafite. Lavabo 60x35x6,5h cm en Shark Zenzero. Módulos auxiliares con puerta batientes 60x18x90h cm en acabado laccado Zenzero mate. Espejo *Filolucido* 240x90h cm.

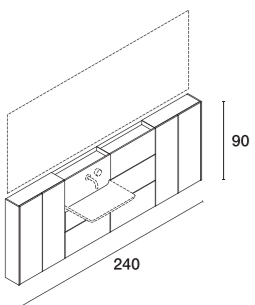

Elements

IT Vision dà vita ad un programma di moduli sospesi e sommabili con vani e modalità di interazione progettati per rispondere alle esigenze quotidiane.

EN Vision introduces a program of suspended and summable modules with units and ways of interaction designed to meet everyday needs.

FR Vision crée un programme d'éléments suspendus et modulaires avec des compartiments et des modes d'interaction conçus pour répondre aux besoins quotidiens.

DE Vision schafft ein Programm von abgehängte und summierbare Module mit Fächern und Interaktionsmöglichkeiten, die auf die Bedürfnisse des Alltags zugeschnitten sind.

ES Vision da vida a un programa de módulos suspendidos que se integran con vanos y elementos para responder a las exigencias cotidianas.

Funzionalità quotidiana /Daily functionality

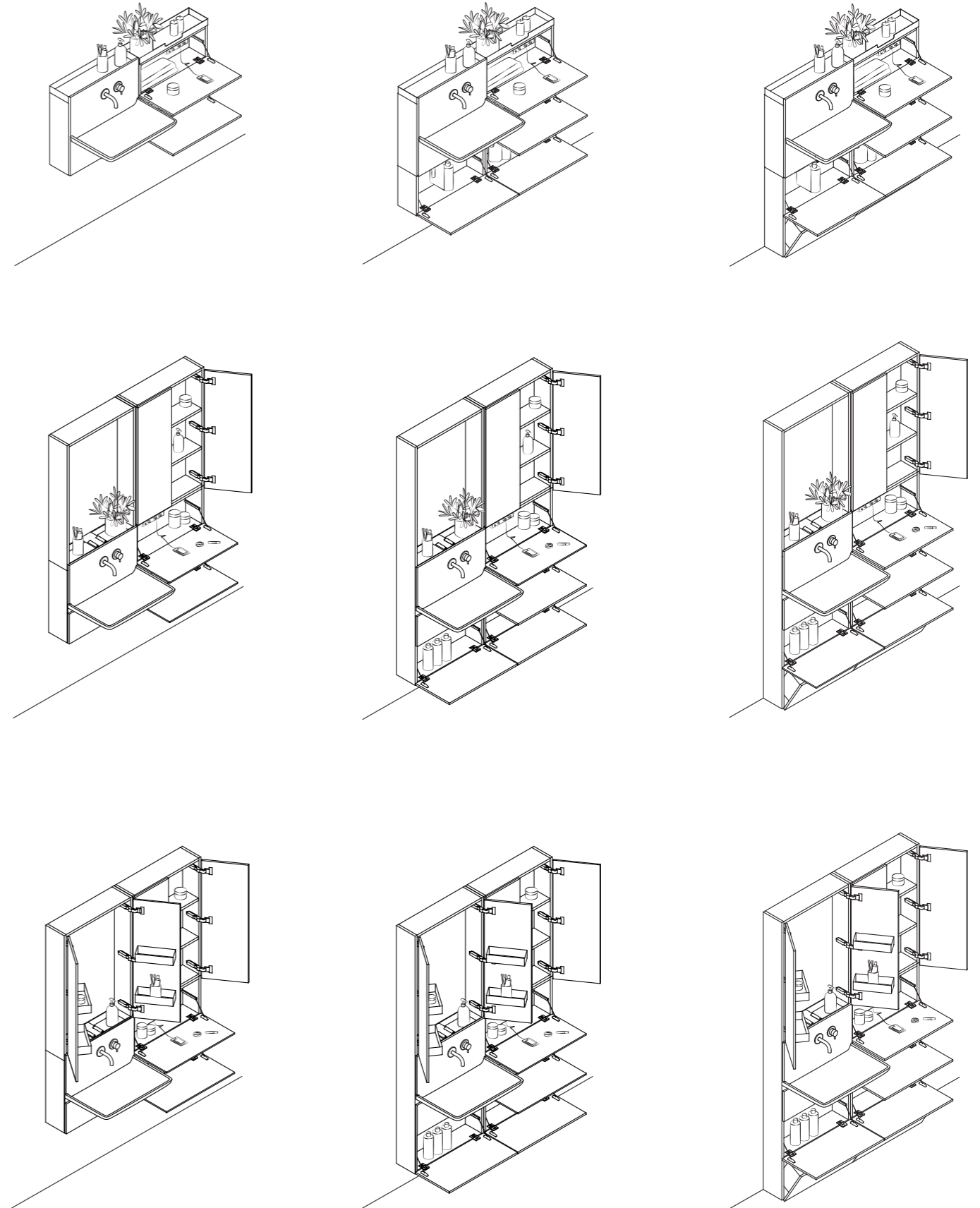

Elementi della collezione/Collection's elements

Moduli lavabo
/Basin modules
L 60-80 P 18

Fenix®
Corian®
Eco.malta
Gres

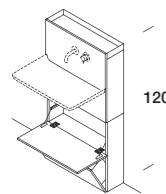
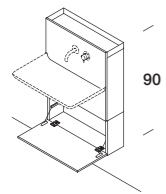
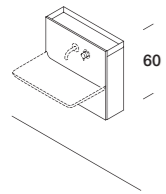

Moduli arredo
/Simple modules
L 60-80 P 18

Laccato opaco
/Matt lacquered
Laccato lucido
/Glossy lacquered
Fenix®
Corian®
Eco.malta
Gres

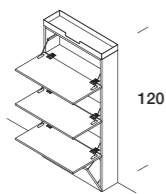
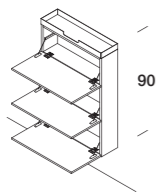
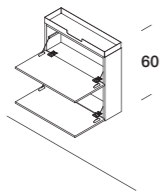

Moduli arredo
/Simple modules
L 30-40 P 18

Laccato opaco
/Matt lacquered
Laccato lucido
/Glossy lacquered
Fenix®
Corian®
Eco.malta
Legno/Wood

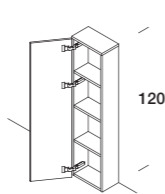
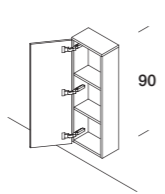
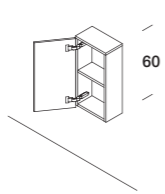

Moduli arredo
/Simple modules
L 60-80 P 18

Laccato opaco
/Matt lacquered
Laccato lucido
/Glossy lacquered
Fenix®
Corian®
Eco.malta
Legno/Wood

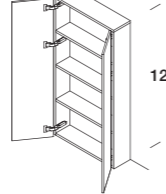
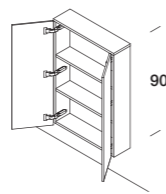
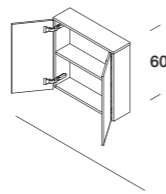

Moduli lavabo con specchiera
/Basin modules with mirror
L 60-80 P 18

Fenix®
Corian®
Eco.malta
Gres

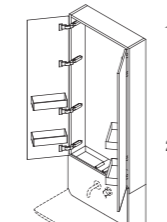
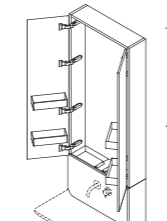
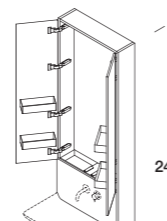
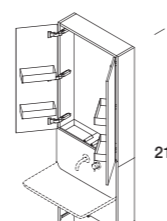
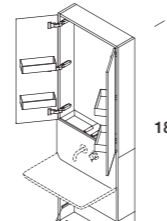
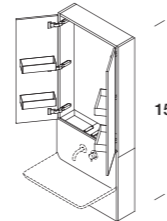

Moduli lavabo con specchiera
/Basin modules with mirror
L 60-80 P 18

Fenix®
Corian®
Eco.malta
Gres

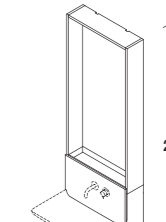
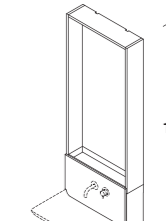
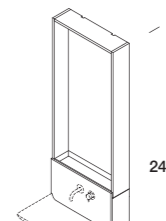
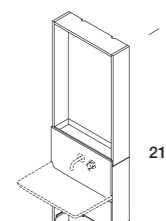
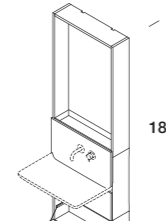
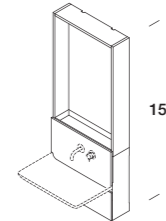

Elementi della collezione/Collection's elements

Pensili
/Wall units
L 60-80 P 18



Laccato opaco/Matt lacquered
Laccato lucido/Glossy lacquered
Fenix®
Corian®
Eco.malta
Gres
Legno/Wood

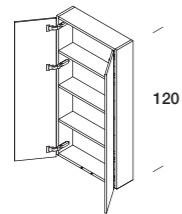
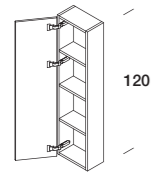
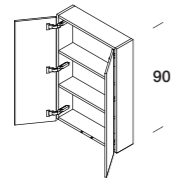
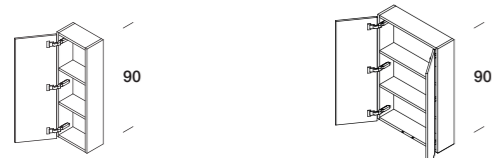

Colonne
/Columns
L 60-80 P 18

Laccato opaco/Matt lacquered
Laccato lucido/Glossy lacquered
Fenix®
Corian®
Eco.malta
Gres

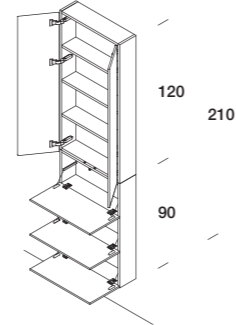
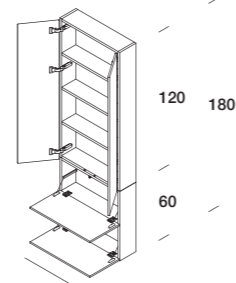
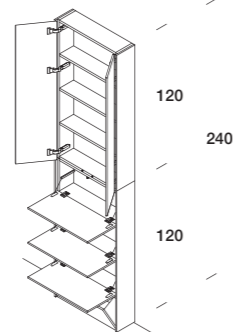
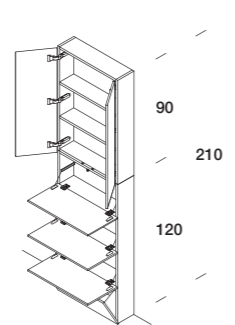
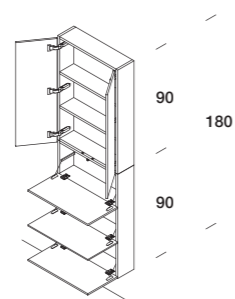
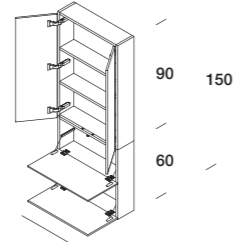

Colonne
/Columns
L 60-80 P 18



Laccato opaco/Matt lacquered
Laccato lucido/Glossy lacquered
Fenix®
Corian®
Eco.malta
Gres
Legno/Wood

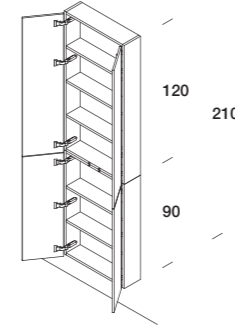
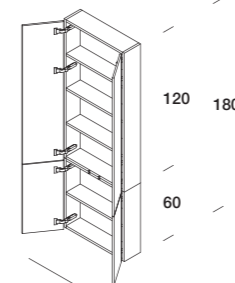
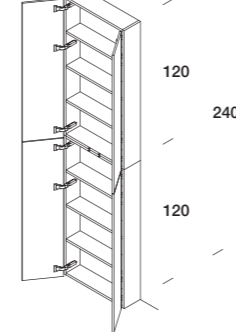
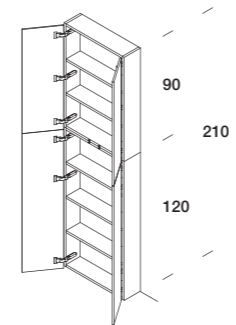
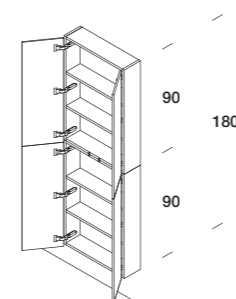
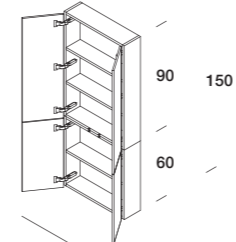

Colonne
/Columns
L 60-80 P 18



Laccato opaco/Matt lacquered
Laccato lucido/Glossy lacquered
Fenix®
Corian®
Eco.malta
Gres
Legno/Wood

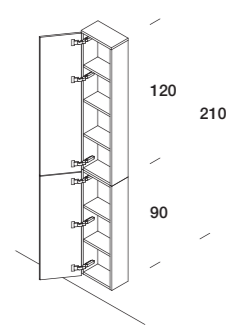
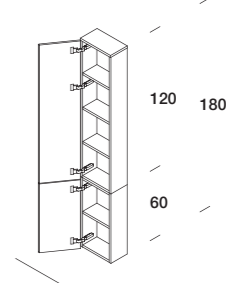
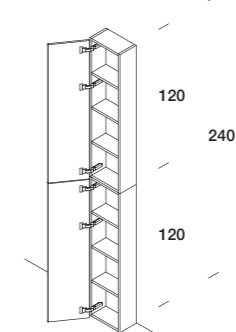
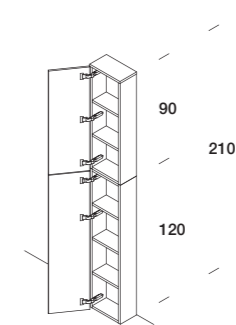
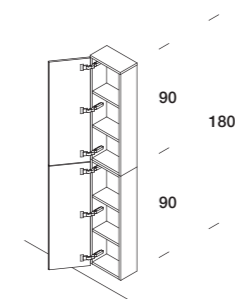
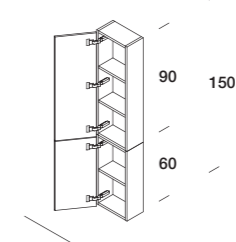

Elementi della collezione/Collection's elements

Specchiere contenitive
/Mirrored cabinets
L 60-80 P 18

Laccato opaco/Matt lacquered
Laccato lucido/Glossy lacquered
Fenix®
Corian®
Eco.malta
Gres
Legno/Wood

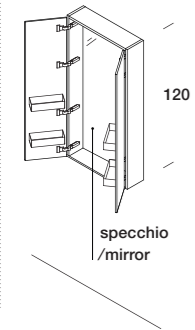
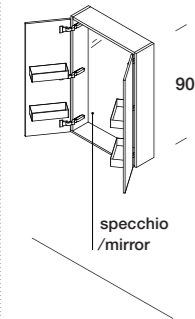

Specchiere contenitive
/Mirrored cabinets
L 90-120 P 18

Laminato grigio/Grey laminate
Laccato opaco/Matt lacquered

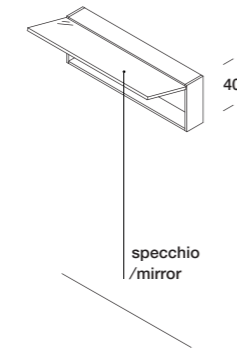

Elementi di tamponamento/Infill panels

Accosto parete con tamponamento sx e dx
/Wall hung installation with left and right infill

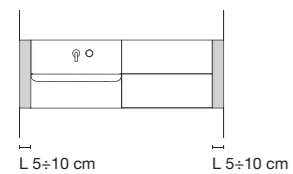

Nicchia con tamponamento sx e dx e tamponamento superiore
/Niche installation with top, left and right infill

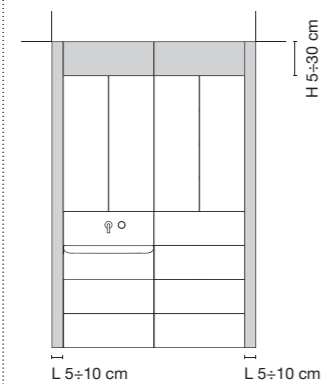

Accosto parete con modulo arredo su misura/Wall hung installation with simple module on measure

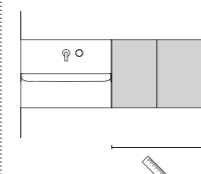

Nicchia con tamponamento superiore e modulo arredo su misura/Niche installation with top infill and simple module on measure

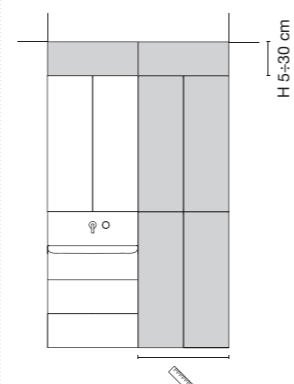

Componibilità/Modularity

A Modulo lavabo + Modulo arredo
/Basin module + Simple module
H 60-90-120

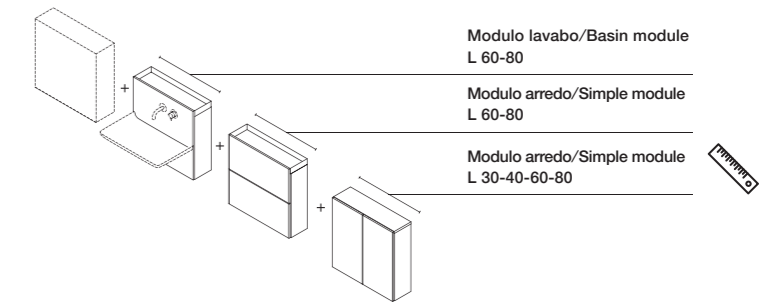

B Modulo lavabo con specchiera + Colonna
/Basin module with mirror + Column
H 150-180-210-240

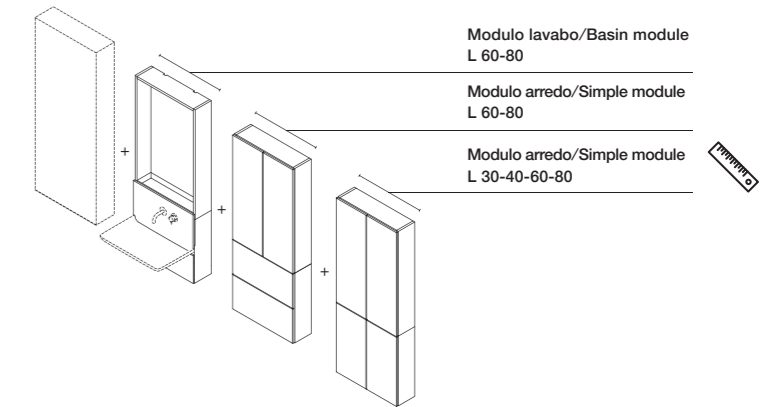

C Colonna + Colonna
/Column + Column
H 150-180-210-240

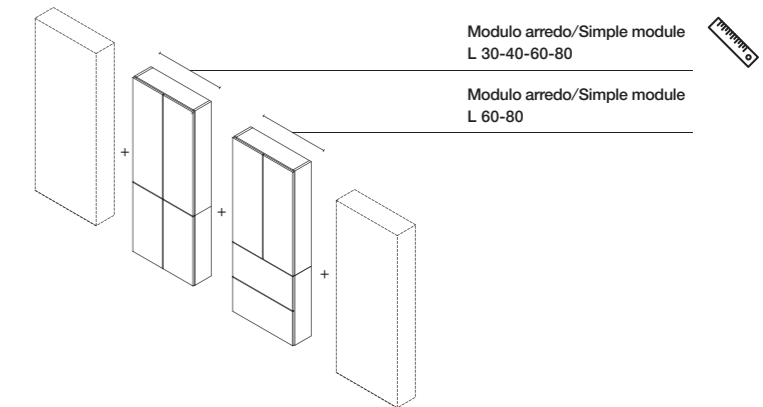

D Pensile, specchiera contenitiva + pensile,
specchiera contenitiva
/Wall unit, Mirrored cabinet + Wall unit,
Mirrored cabinet
H 90-120

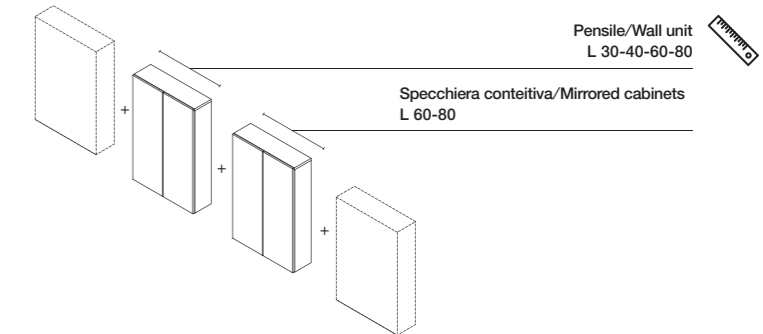



Lavabo/Washbasin

Forma/Shape

Materiali e colori/Materials and colours

A

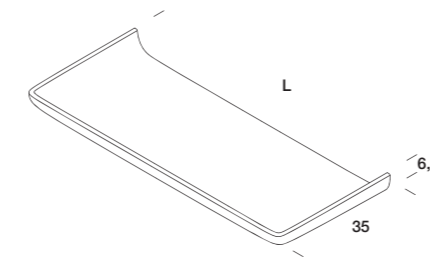

Korakril™ Blend (matt)



K31
Ice White

Shark (matt)



G25
Grigio Luce



G23
Fango Luce



G24
Zenzero



G22
Grafite



G26
Nero

Marmo/Marble



M01
Carrara



M11
Verde Alpi



M09
Nero Marquinia

B

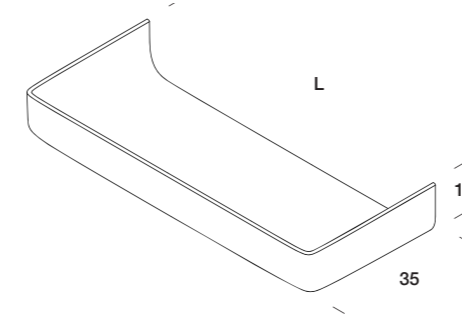

Korakril™ Blend (matt)



K31
Ice White

Shark (matt)



G25
Grigio Luce



G23
Fango Luce



G24
Zenzero



G22
Grafite



G26
Nero

illuminazione/Lighting

IT L1. Illuminazione laterale
L2. Illuminazione lavabo
L3. Illuminazione interna per specchiere e pensili

EN L1. Side lighting
L2. Washbasin lighting
L3. Internal lighting for mirrors and wall units

FR L1. Éclairage latéral
L2. Éclairage lavabo
L3. Éclairage intérieur pour miroirs et éléments hauts

DE L1. Seitenbeleuchtung
L2. Waschbeckenbeleuchtung
L3. Innenbeleuchtung für Spiegel und Oberschränke

ES L1. Iluminación lateral
L2. Iluminación para lavabo
L3. Iluminación interior para espejos y muebles colgantes

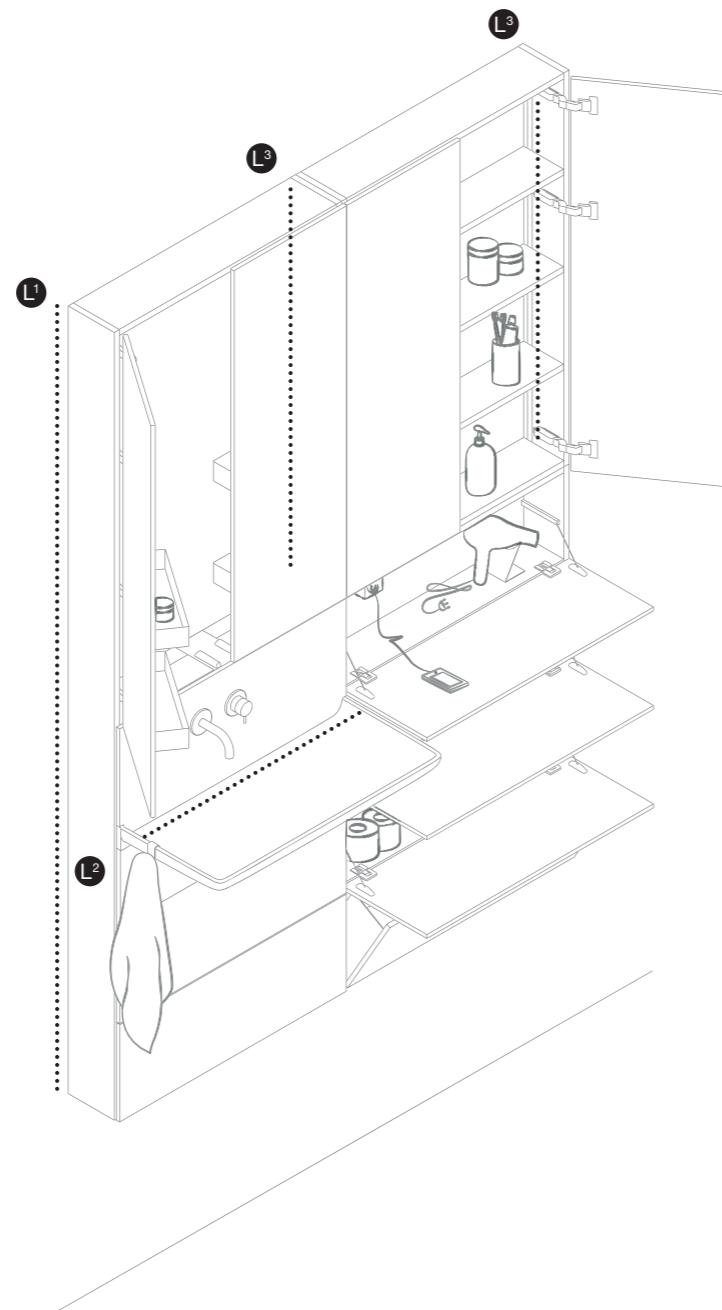

L1



L2

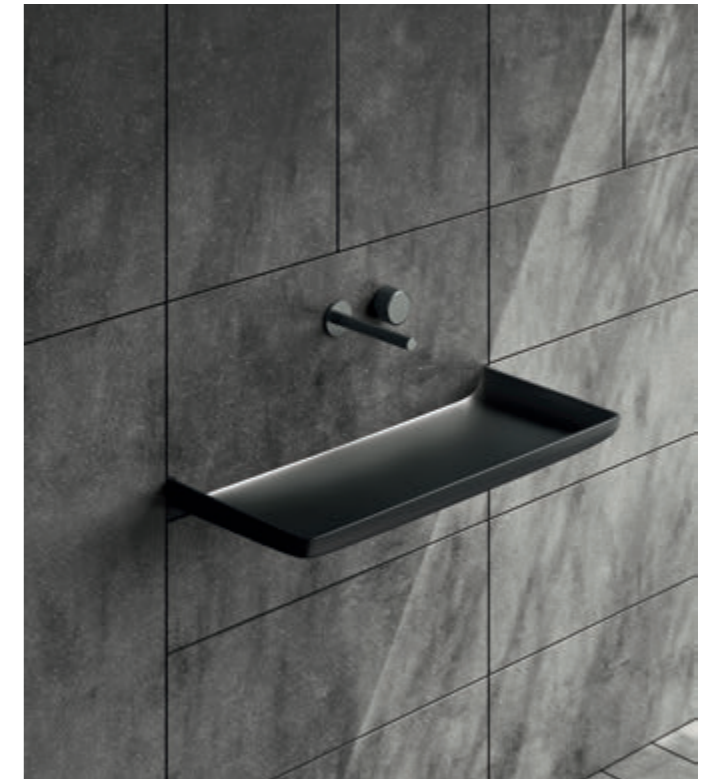

L3

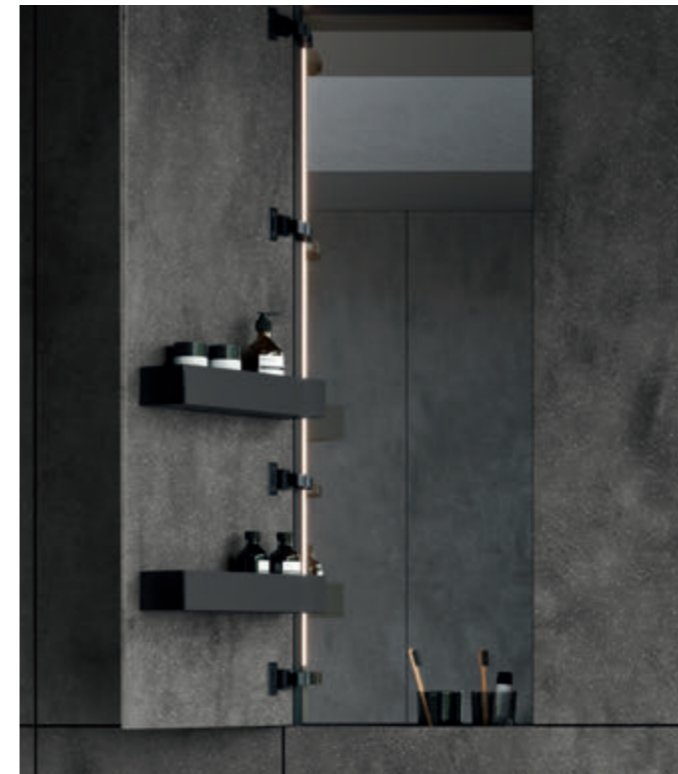

L3



Features

- IT 1. Vaschetta
2. Vaschetta specchiera
3. Apertura anta a ribalta
4. Prese e porta phon*
5. Appendino lavabo*
6. Appendino specchio*

- EN 1. Trays
2. Mirror trays
3. Flap door opening
4. Sockets and hairdryer holder*
5. Washbasin hanger*
6. Mirror hanger*

- FR 1. Bacs
2. Bacs pour miroirs
3. Ouverture porte battante
4. Prises et support de sèche-cheveux
5. Crochet pour lavabo
6. Crochet pour miroir

- DE 1. Tabletts
2. Spiegelnde Tabletts
3. Kippende Türöffnung
4. Steckdosen und Haartrocknerhalter*
5. Waschtischaufhänger*
6. Spiegelaufhänger*

- ES 1. Bandejas
2. Bandejas con espejos
3. Apertura de puerta semi-abatible
4. Enchufe shuko y porta secador*
5. Percha para lavabo*
6. Percha para espejo*

* opzionale/optional/optional
/optional/opcional

1



2



3



3,5



3,6



4



Materials and colours of Rexa

IT Rexa delinea i mondi materici coordinandoli per cromia e tattilità attraverso un sistema intuitivo e logico, pensato per un'efficace progettazione sensoriale dello spazio.

EN Rexa outlines the material worlds coordinating them by colour and tactility through an intuitive and logical system, designed to enhance the sensory spirit of space.

FR Rexa définit les mondes matériels en les coordonnant par chromie et tactilité à travers un système intuitif et logique, conçu pour une efficace conception sensorielle de l'espace.

DE Rexa definiert seine Materialwelten, indem es sie auf der Grundlage von Farben und Taktilität durch ein intuitives und logisches System koordiniert, das für eine wirksame, sensorische Gestaltung des Raums entwickelt wurde.

ES Rexa delinea los materiales coordinándolos por cromia y tacto a través de un sistema intuitivo y lógico, pensado para un eficaz diseño sensorial del espacio.

Come combinare i materiali /How to match materials

Monomaterico/Single-material

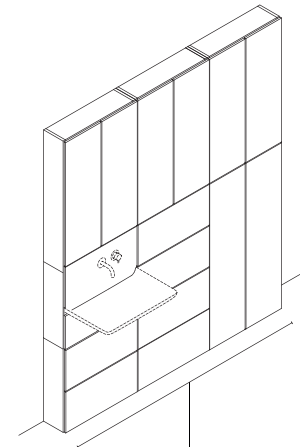

Fenix®
Corian®
Gres
Eco.malta

Multimaterico/Multi-material

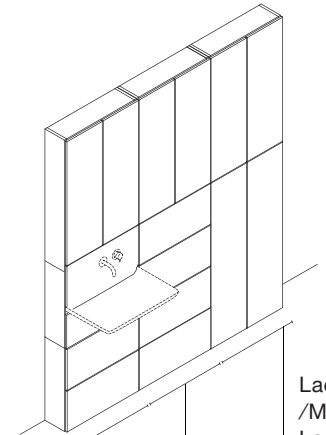

Laccato opaco
/Matt lacquered
Laccato lucido
/Glossy lacquered
Fenix®
Corian®
Eco.malta
Legno/ Wood



Laccato opaco
/Matt lacquered
Laccato lucido
/Glossy lacquered
Fenix®
Corian®
Eco.malta



Fenix®
Corian®
Eco.malta



Laccato/Lacquered (opaco, lucido / matt, glossy)

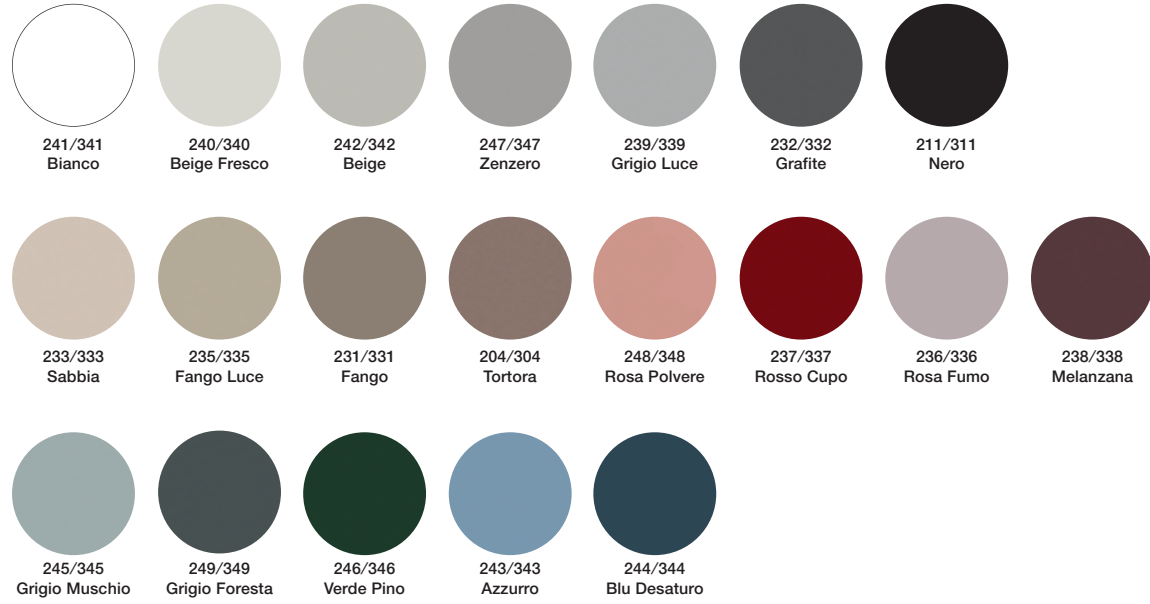

Fenix®



Legno/Wood



Eco.malta

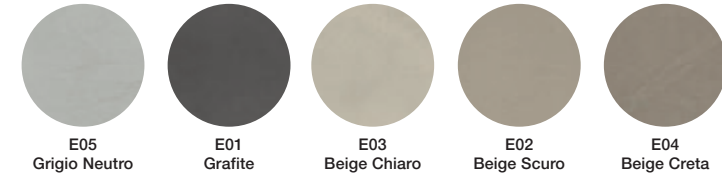

Corian®

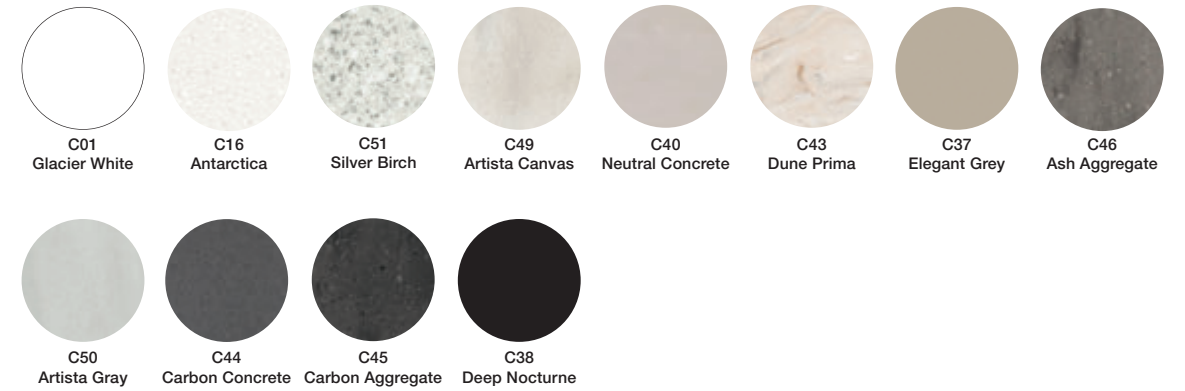

Gres

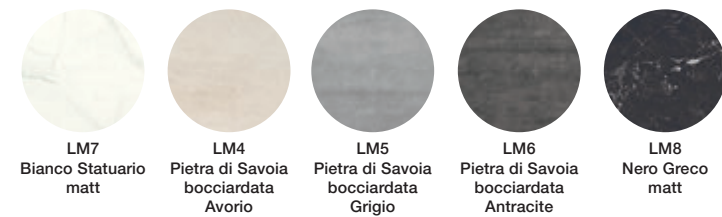

Shark (matt)



Korakrill™ Blend (matt)

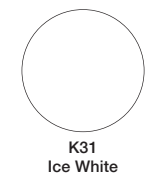

Marmo/Marble

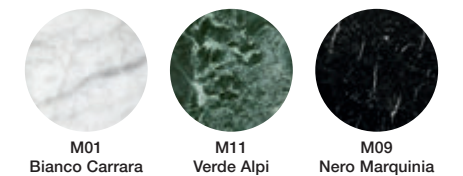

Moods



DARKS

- 1. Marmo/Marble Nero Marquina
- 2. Fenix® Oro Cortez
- 3. Laccato opaco/Matt lacquered Grafite
- 4. Fenix® Nero Ingo
- 5. Eco.malta Grafite



LIGHTS

- 1. Marmo/Marble Bianco Carrara
- 2. Laccato opaco/Matt lacquered Grigio Luce
- 3. Fenix® Grigio Efeso
- 4. Fenix® Bianco Kos
- 5. Eco.malta Grigio Neutro
- 6. Noce Cannettato/Ribbed American Walnut



- GREENS
1. Laccato opaco/Matt lacquered Grigio Foresta
 2. Marmo/Marble Verde Alpi
 3. Laccato opaco/Matt lacquered Verde Pino
 4. Laccato opaco/Matt lacquered Beige Fresco
 5. Fenix® Oro Cortez
 6. Fenix® Verde Comodoro
 7. Corian® Elegant Grey
 8. Eco.malta Beige Chiaro

About



La collaborazione con Monica Graffeo come direttore creativo e product designer ha da sempre ispirato Rexa a indagare il rapporto fra tecnologia, benessere e creatività.

I suoi concept propongono una visione che pone al centro la persona e i suoi bisogni reali, quotidiani. La ricerca sull'evoluzione degli spazi e degli stili di vita e l'attenzione alla percezione sensoriale si traducono in soluzioni che aprono scenari progettuali per gli ambienti casa e contract. **MG:** "La sintonia con Rexa nasce dall'inclinazione condivisa a guardare oltre, mantenendo un forte senso di concretezza. Così è nato Vision: un progetto che ragiona su un contenimento a profondità contenuta e si sviluppa con proporzioni verticali, inglobando il lavabo e lasciando spazio libero per vivere meglio l'ambiente e per trovare le cose proprio dove ci servono, non in seconda o terza fila, ma tutto in primo piano."

The collaboration with Monica Graffeo as creative director and product designer has always inspired Rexa to investigate the relationship between technology, wellness and creativity.

Her concepts suggest a vision that focuses on the person and his/her concrete, everyday needs. The research on the evolution of spaces and lifestyles and the attention to sensory perception are translated into solutions that open up design scenarios for home and contract environments.

MG: "The synergy with Rexa comes from a shared attitude to look beyond, while keeping a strong sense of concreteness. That's how Vision was born: a project that focuses on a limited depth storage concept and develops towards vertical proportions, encompassing the washbasin and leaving free space for an improved space experience, and in order to find things right where we need them, not in the second or third row, but everything in the foreground."

La collaboration avec Monica Graffeo, directrice créative et designer de produits, a toujours inspiré Rexa à enquêter sur le rapport entre technologie, bien-être et créativité.

Ses concepts proposent une vision qui place au centre la personne même et ses besoins réels, quotidiens. La recherche sur l'évolution des espaces et des styles de vie et l'attention à la perception sensorielle se traduisent par des solutions qui ouvrent des scénarios de conception pour les environnements domestiques et contract. **MG:** "La syntonie avec Rexa naît de l'inclination partagée à regarder au-delà,

Monica Graffeo

en maintenant un fort sentiment de concret. Ainsi est né Vision : un projet qui raisonne sur un rangement à profondeur contenue et se développe avec des proportions verticales, en englobant le lavabo et en laissant de l'espace libre pour mieux vivre l'environnement et pour trouver les choses où il nous faut, pas dans la deuxième ou troisième rangée, mais au premier plan."

Die Zusammenarbeit mit Monica Graffeo als Kreativdirektorin und Produktdesignerin hat Rexa stets dazu inspiriert, die Beziehung zwischen Technologie, Wellness und Kreativität zu untersuchen.

Ihre Konzepte legen eine Vision nahe, die sich auf den Menschen und seine konkreten, alltäglichen Bedürfnisse konzentriert. Die Erforschung der Entwicklung von Räumen und Lebensstilen und die Aufmerksamkeit für die Sinneswahrnehmung werden in Lösungen umgesetzt, die Design-Szenarien für Wohn- und Objektbereiche eröffnen.

MG: "Die Synergie mit Rexa ergibt sich aus der gemeinsamen Einstellung, über den Tellerrand hinauszuschauen und gleichzeitig einen starken Sinn für das Konkrete zu behalten. So entstand Vision: ein Projekt, das sich auf ein Stauraumkonzept mit begrenzter Tiefe konzentriert und sich zu vertikalen Proportionen entwickelt, die das Waschbecken einschließen und Freiraum für ein verbessertes Raumerlebnis lassen, und um die Dinge genau dort zu finden, wo wir sie brauchen, nicht in der zweiten oder dritten Reihe, sondern alles im Vordergrund."

La colaboración con Monica Graffeo como directora creativa y product designer ha inspirado Rexa, a investigar la relación entre la tecnología, el bienestar y la creatividad.

Sus conceptos proponen una visión que pone en el centro la persona y sus necesidades reales, cotidianas. La investigación sobre la evolución de los espacios y de los estilos de vida y la atención a la percepción sensorial se traducen en soluciones que abren escenarios de diseño para los ambientes hogar y contract.

MG: "La sintonía con Rexa nace de la inclinación compartida de revisar, manteniendo un fuerte sentido de concreción. Así nació Vision: un proyecto que razona sobre una contención a profundidad contenida y se desarrolla con proporciones verticales, englobando el lavabo y dejando espacio libre para vivir mejor el ambiente y para encontrar las cosas precisamente donde nos sirven, no en segunda o tercera fila, pero todo en primer plano."

Collection



Concept



"The synergy with Rexa comes from a shared attitude to look beyond, while keeping a strong sense of concreteness."



"La sintonia con Rexa nasce dall'inclinazione condivisa a guardare oltre, mantenendo un forte senso di concretezza"

Inside Rexa



IT Esploriamo la stanza da bagno attraverso prospettive progettuali inedite, spinti dalla passione per i materiali e dalla curiosità per i modi di vivere questo spazio della casa, intimo e funzionale allo stesso tempo. Il design, la ricerca e la progettazione sono alla base del nostro operare, ci mettiamo in ascolto del mondo esterno interpretandone le suggestioni e dialoghiamo con i progettisti e i nostri clienti, mettendoci al loro fianco nell'impresa di progettare spazi per la vita delle persone.



EN We explore the bathroom through new design perspectives, driven by the passion for materials and curiosity for the ways of living this space of the house, intimate and functional at the same time. The design, the research and the project are the basis of our work, we listen to the outside world by interpreting its suggestions and we speak with the designers and our customers, sharing with them the business of designing spaces for people's lives.



FR Nous explorons la salle de bain à travers de nouvelles perspectives de design, animés par la passion des matériaux et la curiosité pour les façons de vivre cet espace de la maison, intime et fonctionnel à la fois. Le design, la recherche et le projet sont la base

Inside Rexa

de notre travail, nous écoutons le monde extérieur en interprétant ses suggestions et nous parlons avec les designers et nos clients, partageant avec eux le métier de concevoir des espaces pour la vie des gens.

DE Wir erforschen das Badezimmer aus neuen Designperspektiven, angetrieben von der Leidenschaft für Materialien und der Neugierde, wie man diesen intimen und doch funktionalen Raum im Haus erleben kann. Design, Forschung und Planung sind die Grundlage unserer Arbeit, wir hören auf die Welt da draußen, interpretieren ihre Anregungen und stehen im Dialog mit Designern und unseren Kunden, um gemeinsam mit ihnen Räume für das Leben der Menschen zu gestalten.

ES Exploramos el cuarto de baño a través de perspectivas de diseño inéditas, impulsados por la pasión por los materiales y la curiosidad por las formas de vivir este espacio de la casa íntimo y funcional al mismo tiempo. El design, la investigación y el diseño son la base de nuestro trabajo, nos ponemos a la escucha del mundo exterior interpretando las sugerencias y dialogamos con los diseñadores y nuestros clientes, poniéndonos a su lado en la empresa de proyectar espacios para la vida de las personas.



1 Dive into materials

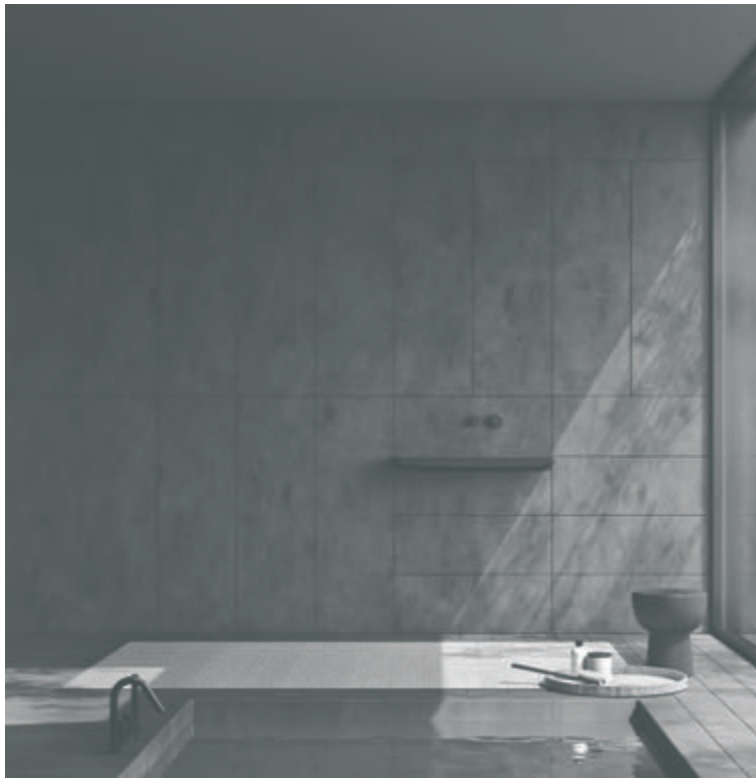

Comp. 1 Corian® Carbon Aggregate Shark Nero p 14

2 Natural essentiality



Comp. 2 Eco.malta Beige Chiaro Shark Nero p 26



Comp. 3 Fenix® Grigio Efeso Marmo/Marble Bianco Carrara p 30

3 A modern way to live



Comp. 4 Corian® Neutral Concrete Korakril™ Blend Ice White p 38

4 Architectural tension



Comp. 5 Corian® Silver Birch Korakril™ Blend Ice White p 44



Comp. 6 Fenix® Oro Cortez Corian® Deep Nocturne Vetro Grigio/Grey glass p 52



Comp. 7 Laccato lucido Grafite /Glossy lacquered Grafite Fenix® Nero Ingo Marmo/Marble Nero Marquinia p 58

5 Embrace new classics



Comp. 8 Laminam Bianco Statuario matt, Nero Shark matt Laccato opaco Grafite/Matt lacquered Grafite Noce Canaletto Cannettato/Ribbed American Walnut p 68

Contatti

per informazioni e contatto
for further information and contact

Rexa Design Srl
Via Maniago 57/a
33080 San Quirino (PN) - Italy
+39 0434 593182
info@rexadesign.it

Flagship Store Milano
Via Molino delle Armi 14
20123 Milano
milano@rexadesign.it

scopri/discover more
rexadesign.it



Credits

Creative direction
– Monica Graffeo

Brochure
– Concept and design
Chiara Torelli
– Image production
Studio Iride
– Styling
Stefano Gaggero
– Photo credits
13 ©Zeynep Sümer, 24 ©Katie
Manning, 36 ©William Peynichou,
50 ©Scott Webb, 66 ©Wolfgang
Hasselmann on Unsplash
– Photolithography
Luce group

Printed in Italy by Sincronia
03 2022

REXA

©2022 Rexa Design Srl
All rights reserved.

progettoincontra2022

CONTRA
Rete d'impresa
incontrasolutions.it



